



Aqua Marina
Bath Design Vol. 01

Il Paralume Marina



Art. BA594

Art. BA595

Art. BA596

Art. BA597

Art. BA598

Art. BA599

Art. BA616

Art. BA608

Dispenser porta sapone cristallo graffiato
Liquid soap dispenser scratched crystal

H 16 cm ø 11cm

design: Arch. Federica Vicentini

Aqua Marina

Bath Design Vol. 01



Bubbles

Bolle di cristallo italiano interamente molate a mano, versatili per ogni esigenza ed estremamente eleganti donano un tocco di modernità e delicatezza ad ogni ambiente

Bubbles

Cristallo Graffiato Transparente
Clear Scratched Crystal

II Paratume Marina

2



Art. BA605 Tray
H 2 cm L 36x15 cm



Art. BA606
H 10 cm ø 11 cm



Art. BA608
H 16 cm ø 11 cm



Art. BA602
H 14 cm ø 16 cm



Art. BA601
H 17 cm ø 20 cm



Art. BA604
H 3 cm ø 12 cm

Art. BA681
Watertap
H 35 cm L 27,3 cm

Art. BA676
Washbasin
scratched crystal
H 15 cm ø 44 cm

Art. BA682
Open drain
+ Metal ring
H 2,1 cm ø 6,2 cm



Art. BA603
H 7 cm ø 7 cm



Art. BA607
H 8 cm ø 47 cm



Art. BA600
H 24 cm ø 26 cm

Bubbles

Italian crystal bubbles
entirely hand-made,
suitable for all requirements
and extremely elegant,
giving a touch of modernity
and softness to any room

Bubbles

Cristallo lucidato fumè
Polished fumè crystal

Art. BA616 H 16 cm ø 11 cm



Art. BA615 H 10 cm ø 11 cm



Art. BA611 H 14 cm ø 16 cm



Art. BA613 H 3 cm ø 12 cm



Art. BA612 H 7 cm ø 7 cm



Art. BA617
H 8 cm ø 47 cm



Art. BA610
H 17 cm ø 20 cm



Art. BA609
H 24 cm ø 26 cm



Set in cristallo italiano molato a mano
Bathroom set made on italian hand-cutted crystal

Art. BA681 Watertap
H 35 cm L 27,3 cm

Art. BA675 Washbasin
H 15 cm ø 44 cm

Art. BA682
Open drain + Metal ring
H 2,1 cm ø 6,2 cm



Art. BA675 Washbasin
H 15 cm ø 44 cm



Paralume Marina

6

Porta asciugamani con barra in ottone e sfera in cristallo trasparente molato



Art. BA629 H 7 cm L 120 cm Sp 12 cm

Art. BA630 H 7 cm L 60 cm Sp 12 cm

Art. BA631 H 7 cm L 40 cm Sp 12 cm

Bubbles Collection

Nastri in barre di ottone avvolgono una sfera di cristallo italiano molato a mano. Design e tradizione per creare esclusivi ambienti made in Italy

*Brass rod ribbons surround hand-made Italian crystal spheres.
Design with tradition creates exclusive interiors made in Italy*



Art. BA628
H 7 cm L 27 cm Sp 15 cm

Art. 1999
H 100 cm ø 100 cm
12 x G9 x 40W



Bubbles Collection

Nastri in barre di ottone avvolgono una sfera di cristallo italiano molato a mano.
Design e tradizione per creare esclusivi ambienti made in Italy

*Brass rod ribbons surround hand-made Italian crystal spheres.
Design with tradition creates exclusive interiors made in Italy*



Art. BA624/P
H 62 cm L 36x38 cm

Art. BA624/G
H 62 cm L 61x38 cm

Aqua Marina 9 

Mensola in ottone e pvc con cristallo trasparente molato
Brass shelf and PVC with transparent crystal ball

Art. BA626/LU
H 8 cm L 60 cm Sp 15 cm



Art. BA625
H 15 cm L 60 cm Sp 15 cm



Bubbles Collection

Nastri in barre di ottone avvolgono una sfera di cristallo italiano molato a mano. Design e tradizione per creare esclusivi ambienti made in Italy

Brass rod ribbons surround hand-made Italian crystal spheres. Design with tradition creates exclusive interiors made in Italy

Art. BA670 H 7 cm L 120 cm Sp 12 cm

Art. BA671 H 7 cm L 60 cm Sp 12 cm

Art. BA672 H 7 cm L 40 cm Sp 12 cm



Art. BA627
H 7 cm L 27 cm Sp 15 cm





Art. BA623
H 69 cm L 22x16 cm

Art. BA621
H 103 cm L 72x25 cm



Art. BA620
H 103 cm L 72x25 cm

Art. BA622
H 69 cm L 22x16 cm



Art. BA638
H 45 cm L 120 cm Sp 4,5 cm
170 Led x 1W 12V
(driver included)

Lavandino in cristallo italiano
molato a mano
*Bathroom sink made on italian
hand-cutted crystal*



Art. BA677
H 15 cm ø 44 cm

Art. BA682
Open drain + Metal ring
H 2,1 cm ø 6,2 cm

Art. BA681 Watertap
H 35 cm L 27,3 cm

Art. BA425
H 33 cm ø 20 cm



Art. BA423
H 15 cm L 13x13 cm



Art. BA424/G
H 16 cm ø 22 cm

Art. BA421
H 23 cm ø 9 cm

Art. BA420
H 14 cm ø 9 cm

Art. BA424/P
H 13 cm ø 18 cm



Art. BA421/wall
H 23 cm Sp 12 cm

Art. BA419
H 2 cm L 36x15 cm



Art. BA420/wall
H 14 cm Sp 12 cm

Art. BA418
H 3 cm L 13 cm



Art. BA424/P
H 13 cm ø 18 cm



Art. 1913/CH8/NN
H 80 cm ø 92 cm Pø 15 cm
8 x E14 x 40W + 3 Dicroiche 60W



Art. 1913/A1/KR
H 44 cm L 19 cm
Sp 18 cm Pø 15 cm
1 x E14 x 60W



Art. BA618
Enlarge mirror 2X with 3 Led
x 1,2W white 4000 K
L 22,5 x 22,5 cm Sp max 38 cm



Art. BA619
Enlarge mirror 2X
H 42 cm L 22,5x22,5 cm

Lavandino in cristallo Italiano molato a mano
Bathroom sink made in italian hand-cutted crystal

Art. BA681 Watertap
H 35 cm L 27,3 cm

Art. BA678 Washbasin
H 15 cm ø 44 cm



Art. BA682
Open drain + Metal ring
H 2,1 cm ø 6,2 cm

King Collection

Il Cristallo italiano interamente molato a mano
danza con elementi in fusione di ottone cromato in
una combinazione emozionante di design classico

*Italian Crystal entirely made and engraved by hand
blends perfectly with chrome brass giving rise to the
exciting combination of classic design*

Итальянский хрусталь, изготовленный и
вырезанный полностью вручную в интересном
сочетании с хромированной латунью, придаёт
коллекции нотки классического стиля

Art. BA437/KR/VI
H 18 cm ø 8 cm

Art. BA437/KR/RS
H 18 cm ø 8 cm

Art. BA437/KR/AM
H 18 cm ø 8 cm

Art. BA437/KR/GL
H 18 cm ø 8 cm

Art. BA437/KR/AZZ
H 18 cm ø 8 cm

Art. BA437/KR/FUME'
H 18 cm ø 8 cm

Art. BA437/KR/TR
H 18 cm ø 8 cm



Art. BA437/KR/RS
H 18 cm ø 8 cm

Art. BA436
H 12 cm ø 8 cm

Set in cristallo rosa
italiano molato a mano
*Set in pink Italian
hand-engraved crystal*
Комплект из розового итальянского
хрусталя, гравированного вручную



Art. BA438/wall
H 21 cm L 23 cm Sp 12 cm



Art. BA437/wall
H 21 cm ø 10 cm Sp 13 cm



Art. BA436/wall
H 15 cm ø 10 cm Sp 13 cm



Art. BA439
H 13 cm L 15x15 cm



Art. BA435
H 8 cm L 20x14 cm



Art. BA432
H 26 cm ø 20 cm

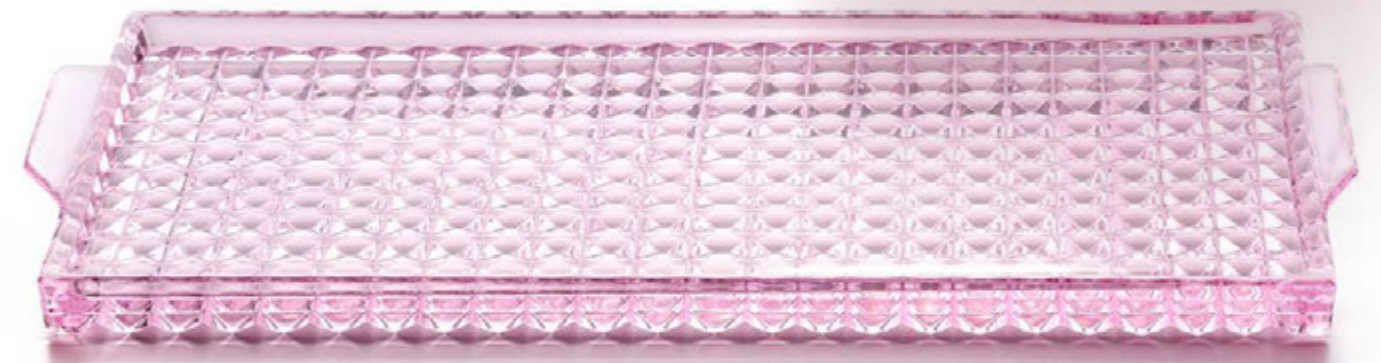

Art. BA434
H 2 cm L 36x15 cm

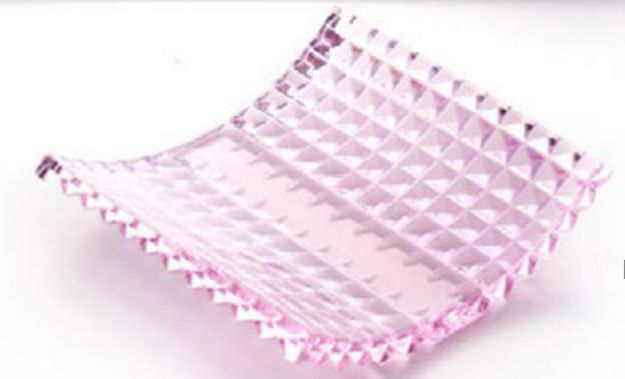

Art. BA433
H 3 cm L 13 cm

“Cristalli Profumati”

Tecnologia Oikos Fragrances

Naturale come un soffio d'aria pura

La tecnologia brevettata SFR (Solid Fragrance Release) permette di utilizzare fragranze, profumi e note odorose allo stato solido che vengono diffuse naturalmente, per semplice ventilazione. Il soffio d'aria generato lambisce la superficie della ricarica profumata e porta in atmosfera la profumazione senza uso di solventi, senza riscaldamento e senza nebulizzazione. La ventilazione naturale garantisce la massima qualità e gradevolezza della profumazione, con un rilascio controllato e programmato.

“Scented Crystals”

Oikos Fragrances Technology

The patented SFR technology (Solid Fragrance Release) allows the use of solid state fragrances, that are released naturally, by simple ventilation. A gentle blow, created by a small fan, brushes the surface of the perfumed refill and diffuses the fragrance in the air without heating and vaporizing it and without using solvents. And this natural ventilation, with the help of controlled release technology, guarantees best quality and pleasantness of scent diffusion.

«Ароматные кристаллы»

Технология Oikos Fragrances - Естественный как глоток свежего воздуха

Запатентованная технология SFR (Solid Fragrance Release) позволяет использовать духи и ароматы в твердом состоянии, благодаря чему распространение идет натуральным путем посредством простого выветривания. Поток воздуха, слегка касаясь душистой поверхности, наполняет помещение ароматом без использования растворителей, нагревания или распыления. Естественная вентиляция гарантирует максимальное качество и удовольствие от аромата благодаря программированной и контролируемой подаче.

1) CITRUS FRUITS Art. PLMC30

Energizzante, stimolante agrumato e frizzante, unisce alla freschezza del pompelmo e del mandarino, l'evanescenza del gelsomino e l'intensità dei chiodi di garofano.

1) CITRUS FRUITS Art. PLMC30

The freshness of grapefruit and tangerine, the evanescence of jasmine, the intensity of cloves.

1) CITRUS FRUITS Art. PLMC30

В игристом цитрусовом аромате доминирует гранат и мандарин, на фоне которых замирает жасмин и гвоздика.

2) HELIOTROPIUM Art. PLMH25

Voluttuoso, solare, intenso La solarità del fiore d'eliotropio, impreziosita da tocchi di vaniglia e ambra.

2) HELIOTROPIUM Art. PLMH25

The sunny side of the Heliotropium flower, heightened by touches of vanilla and amber.

2) HELIOTROPIUM Art. PLMH25

Вся насыщенность цветка гелиотропа, обогащенного нотками ванили и амбры.

3) AMBER Art. PLMA40

Seducente, elegante Accordo ambrato di legni e resine sostenuto da aromi di chiodi di garofano e cardamomo.

3) AMBER Art. PLMA40

An amber combination of wood and resin essences backed by aromas of cloves and cardamom.

3) AMBER - Art. PLMA40

Сочетание запахов дерева и смол сливается с ароматами гвоздики и кардамона.

4) JASMINE & TEA Art. PLMJ35

Rilassante - equilibrante L'intensità del gelsomino per stemperare il profumo persistente del tè verde.

4) JASMINE & TEA Art. PLMJ35

The intensity of jasmine downplays the persistent scent of green tea.

4) JASMINE & TEA Art. PLMJ35

Интенсивность жасмина вторгается в насыщенный аромат зеленого чая.

I profumi vengono forniti in due versioni:

- Kit monofragranza da 4pz
- Kit fragranze miste da 4 pz (cod PLMS50)

The fragrances are provided in 2 versions:

- Kit mono fragrance 4 pieces
- Kit mixed fragrances 4 pieces (code PLMS50)

Ароматы предоставлены в 2-х вариантах:

- Комплект моноаромат 4 шт.
- Комплект из разных ароматов 4 шт. (cod PLMS50)



Art. BA517
L 16x16 cm H 15 cm
Strip Led 2,4W
light on

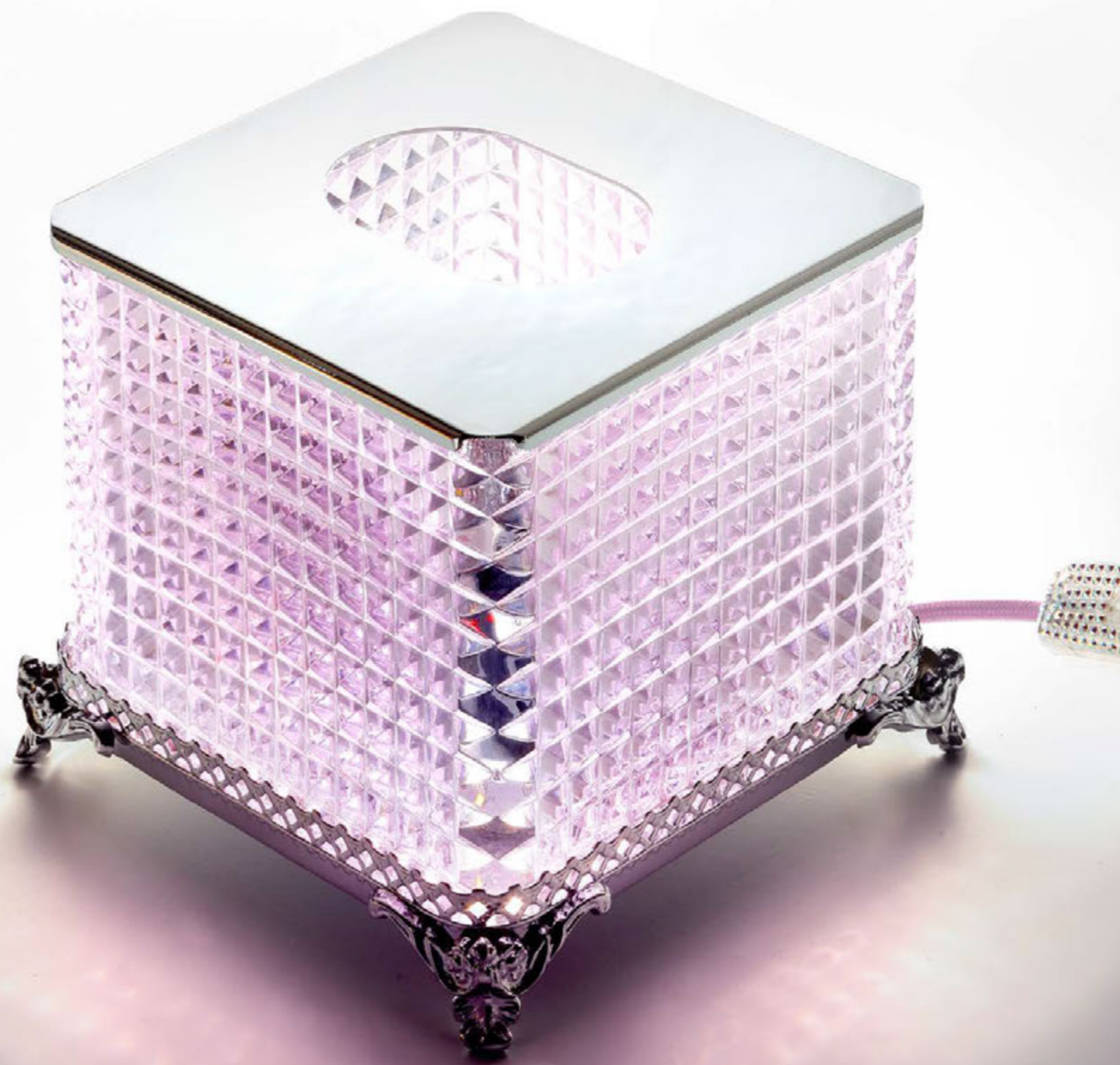

Diffusore di fragranze in cristallo rosa italiano molato a mano ed elementi in ottone cromato con accensione simultanea di luce interna a led

Fragrance releaser in pink Italian hand-cut crystal and brass elements in chrome plating with simultaneous internal led lighting

Распылитель ароматов из розового итальянского хрусталя, гравированного вручную, с элементами из хромированной латуни, оснащен синхронизированным внутренним светодиодным освещением



Art. BA494
H 6 cm L 55 cm Sp 22 cm

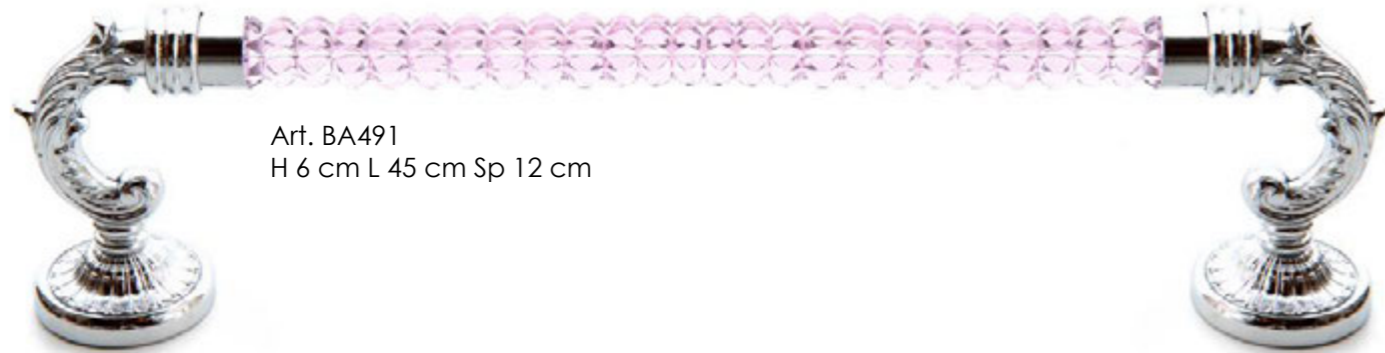

Art. BA491
H 6 cm L 45 cm Sp 12 cm



Art. BA492
H 6 cm L 37 cm Sp 12 cm

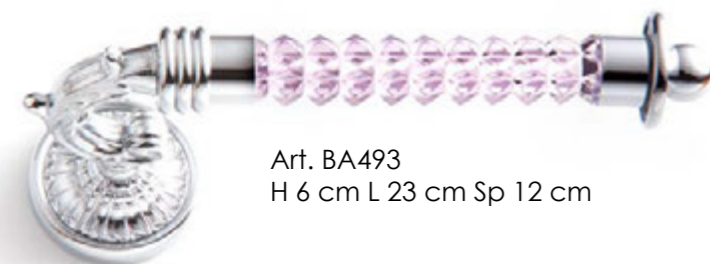

Art. BA493
H 6 cm L 23 cm Sp 12 cm



Art. BA691
H 7 cm L 13 cm Sp 15 cm



Art. BA498
H 45 cm ø14 cm



Art. BA497
H 43 cm L 22 cm
Enlarge mirror 2X
ø 18 cm



Art. BA495
H 10 cm L 6 cm Sp 11 cm



Art. BA490
L 24x24 cm Sp 11 cm



Art. ST51
 Pole: ø 40 mm
 Final part: H 24 cm L 25 cm
 Bracket: Sp 18 H 14 cm

Ring
 Art. ST52/KR
 ø int. 5,5 cm ø est. 7 cm

Art. ST50
 H 10 cm L 6 cm Sp 11 cm



Art. BA496/wall
 H 45 cm ø 18 cm
 Sp min 9 cm
 Sp max 58 cm
 Enlarge mirror 2X
 ø 18 cm



Art. BA515/wall
H 100 cm L 83 cm



Art. 1914/CH12
H 60 cm ø 103 cm
12 x E14 x 40W

Queen Collection

Collezione di corpi illuminanti in fusione di ottone e cristallo fiorentino trasparente molato a mano

Collection of lighting objects in cast brass and Florentine crystal cut by hand

Коллекция осветительных приборов из литой латуни и прозрачного флорентийского хрустала, гравированного вручную

Art. 1914/CH6
H 41 cm ø 83 cm
6 x E14 x 40W



BA507/wall
H 28 cm L 27 cm
Sp max 48 cm
Enlarge mirror 2X
ø 18 cm



Art. 1914/A2
H 38 cm L 41 cm
2 x E14 x 40W

Art. BA510
H 14 cm ø10 cm



Art. BA509
H 19 cm ø 10 cm

Art. BA512
H 35 cm
ø 22 cm



Art. BA513
H 22 cm ø 16 cm

Art. BA511
H 50 cm
ø 14 cm





Art. BA505
H 16 cm L 55 cm Sp14 cm

Art. BA690
L 26 cm H 7 cm Sp 17 cm



Art. BA514
H 100 cm L max 60 cm

Art. BA503
H 34 cm L 50 cm Sp 7 cm

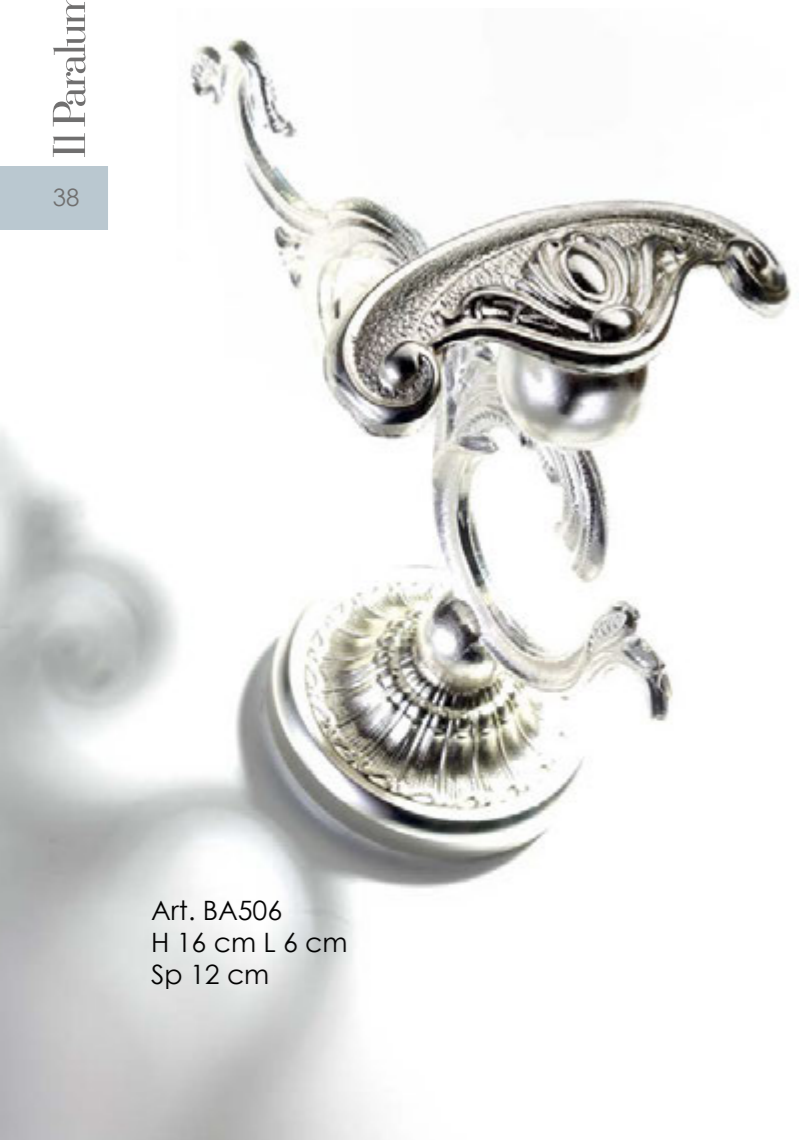

Art. BA506
H 16 cm L 6 cm
Sp 12 cm



Art. BA504
H 6 cm L 28 cm
Sp 12 cm



Art. BA502
H 6 cm L 60 cm
Sp 12 cm



Art. BA501
H 6 cm L 70 cm
Sp 12 cm



Art. ST54
 Pole: ø 40 mm
 Final part 1: H 12 cm L 32 cm
 Pole: ø 25 mm
 Final part 2: L 6 cm

Ring
 Art. ST52/AV
 ø int. 5,5 cm
 ø est. 7 cm



Art. ST53
 H 16 cm L 6 cm
 Sp 14 cm

Art. BA500
 H 32 cm ø 21 cm
 Sp 12 cm

Queen Collection

La fusione di ottone è protagonista di questa collezione di elementi di arredo bagno che creano atmosfere di altri tempi

Brass casting is the protagonist of this collection of the elements for bathroom, it's forms and colours create a special atmosphere

Центральной фигурой этой коллекции является литая латунь, создающая атмосферу былых времён



Art. BA508
 H 40 cm L 27 cm
 Enlarge mirror 2X
 ø 18 cm

Ossidiana

Quarzo Blu

Amazonite

Malachite

Occhio Di Tigre

Quarzo Rosa

Madrepetra



Art. BA471/AV/QUARZOROSA
H 7 cm L 23 cm Sp 13 cm

Lady

Quarzo, malachite, occhio di tigre, madreperla: cabochon di alta gioielleria vengono accostati ad accessori da bagno. Il design esclusivo del tubo diamantato puntinato rende carezzevoli le superfici che ora sonolucide, ora opache ora stupefacemente variopinte

Quartz, malachite, tiger's eye, nacre: cabochon of fine jewelry revive on bath accessories. Dimpled tube gives to the surfaces a special multicolor effect: you can see them either shiny or matt, it's changing tones attract and fascinate

Кварц, малахит, тигровый глаз, перламутр, - благодаря изящным кабошон аксессуары становятся произведениями изысканного ювелирного искусства. Эксклюзивный дизайн трубок в специальной рельефной обработке с впадинками придаёт поверхностям особый эффект, позволяющий под разными углами видеть их то блестящими, то матовыми. Захватывающее разнообразие оттенков увлекает, вызывает интерес и желание прикоснуться



Art. BA471/KR/SW
H 7 cm L 23 cm Sp 13 cm



Art. BA471/BR/MADREPERLA
H 7 cm L 23 cm Sp 13 cm



Art. BA471/ KR/OSSIDIANA
H 7 cm L 23 cm Sp 13 cm



Art. BA471/ORO24/MALACHITE
H 7 cm L 23 cm Sp 13 cm



Art. BA474
H 7 cm L 13 cm Sp 9 cm



Art. BA471/ORO24/MALACHITE
H 7 cm L 23 cm Sp 13 cm



Art. BA477
H 100 cm L tot. 60 cm

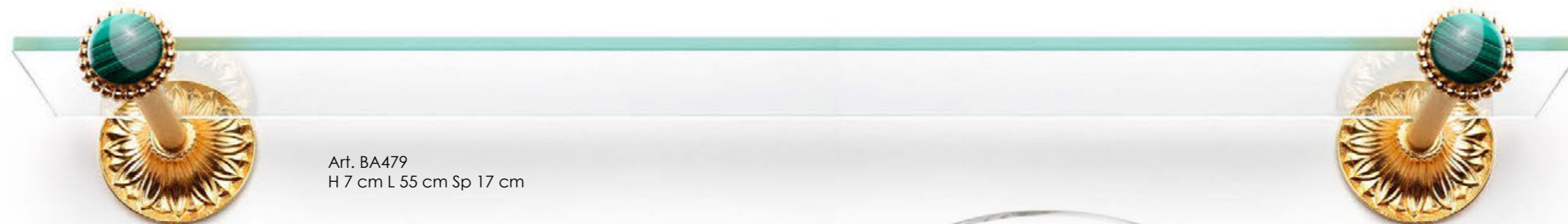

Art. BA479
H 7 cm L 55 cm Sp 17 cm

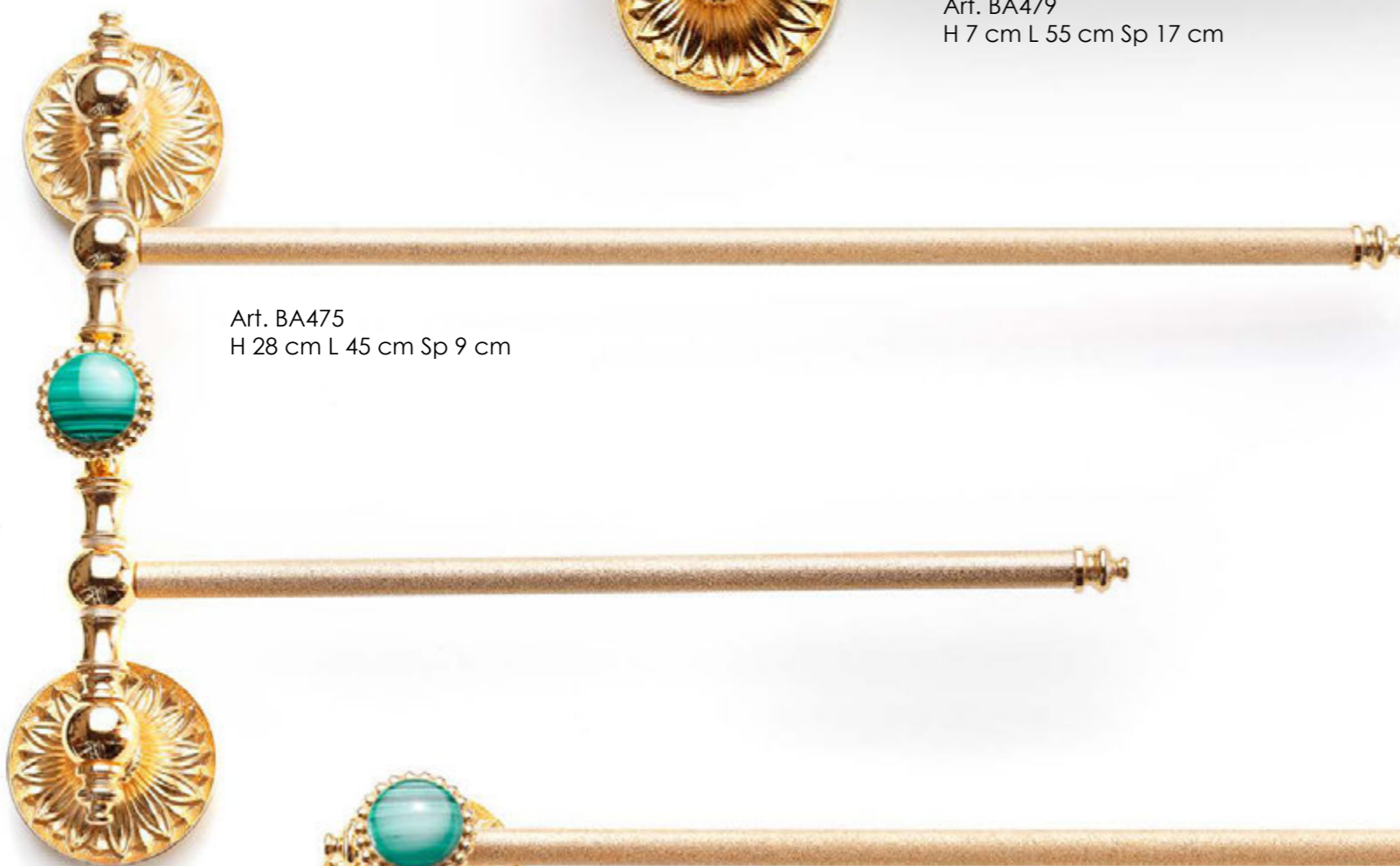

Art. BA475
H 28 cm L 45 cm Sp 9 cm



Art. BA689
H 7 cm L 17 cm Sp 14 cm



Art. BA472
H 7 cm L 50 cm Sp 9 cm



Art. BA473
H 7 cm L 35 cm Sp 9 cm



Art. BA470
H 24 cm ø 21 cm Sp 9 cm



Art. ST45/SW
Sp max 17,5 cm
Final part 1: ø sfera 6 cm L 14 cm
Final part 2: ø sfera 4 cm L 5,5 cm



Art. ST46
H 11 cm L 7 cm
Sp 12 cm
Crystal ball ø 4 cm



Art. BA476
H 40 cm L 22 cm
Enlarge mirror 2X
ø 18 cm



Art. BA478/wall
H 44 cm ø 18 cm
Sp min 9 cm Sp max 58 cm
Enlarge mirror 2X
ø 18 cm



Art. 1912/CH8/ORO24
H 75 cm ø 111 cm
Pø 18 cm
8 x E14 x 40W



Serie di corpi illuminanti dal design esclusivo del tubo diamantato puntinato, i paralumi in tessuto metallico grinzato su pvc trasparente vengono delineati dal telaio metallico lucente in un accoppiamento deciso ed equilibrato

Set of lighting objects by exclusive design obtained from dimpled tube, lampshades in fabric with copper on transparent pvc base and shiny metal parts make this combination well-balanced

Неповторимый дизайн новой коллекции осветительных приборов достигнут при помощи эксклюзивной пунктирной обработки металла и абажуров из ткани с волокнами из меди; все это подчеркнуто блестящим металлическим каркасом, создавая решительную и гармоничную композицию

Art. BA590/wall
H 100 cm L 76 cm



Art. 1912/CH5/KR
H 54 cm ø 74 cm Pø 18 cm
5 x E14 x 40W

Aqua Marina 49



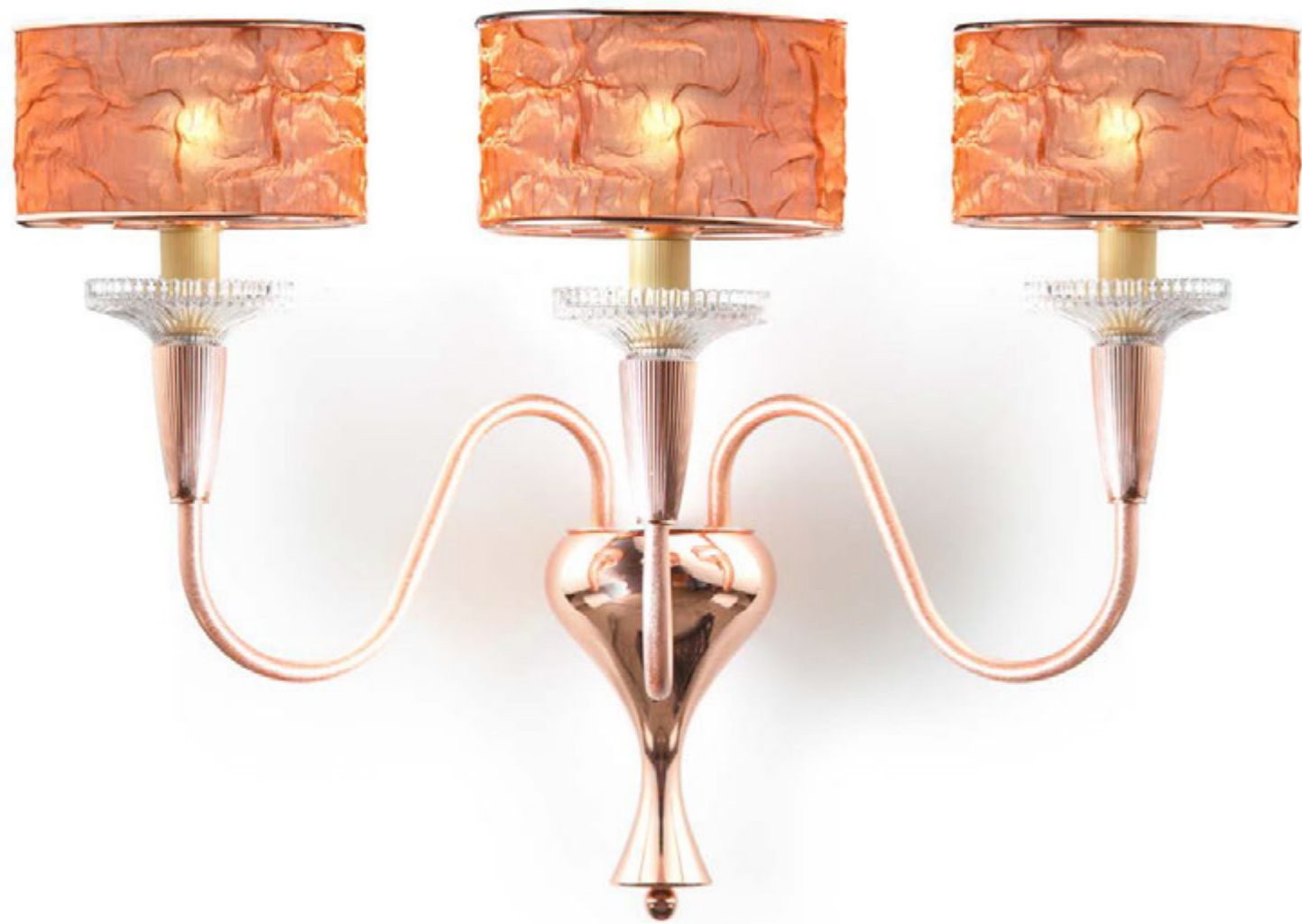

Art. 1912/A3
H 50 cm L 67 cm
Sp 44 cm Pø 18 cm
3 x E14 x 40W



Art. 1912/G
H 82 cm Pø 40 cm
1 x E27 x 60W



Art. 1912/P
H 46 cm Pø 25 cm
1 x E27 x 60W



Art. BA230
H 18 cm ø 10 cm

Art. BA231
H 13 cm ø 10 cm



Art. BA258
H 18 cm ø 10 cm



Art. BA259
H 13 cm ø 10 cm



Art. BA464
H 80 cm ø 46 cm

Set Pietre di Luna

Collezione in ottone bagno oro-24k
e sfera di Murano trasparente-oro

Gold 24k brass collection and
transparent-gold sphere Murano glass



Art. BA228
H 36 cm L 50 cm Sp 7 cm



Art. BA226
H 6 cm L 24 cm Sp 12 cm



Art. BA225
H 6 cm L 13 cm Sp 8 cm



Art. BA224
H 24 cm ø 21 cm
Sp 8 cm



Art. BA227
H 6 cm L 55 cm Sp 8 cm

Prince Collection

Collezione di accessori da bagno dal design maschile, dove la fusione di ottone è costretta a forme semplici e lucide: protagonista è il tubo a torciglione in vetro di Murano trasparente e oro. Eleganza stilizzata by IL PARALUME MARINA

The set of bath accessories by masculine design with brass casted in simple and essential shiny forms. The central figure is twisted tube made in Murano glass of transparent and gold colour. Stylized elegance by IL PARALUME MARINA

Серия аксессуаров для ванн с мужским характером. В ней доминируют простые и сияющие формы из литой латуни, которые являются обрамлением к главному элементу - витой трубке из прозрачного с золотом муранского стекла. Стилизованная элегантность от IL PARALUME MARINA



Art. BA525
H 4 cm L 55 cm Sp 20 cm



Art. BA521
H 4 cm L 72 cm Sp 8 cm



Art. BA522
H 4 cm L 55 cm Sp 8 cm



Art. BA523
H 4 cm L 49 cm Sp 8 cm



Art. BA530
ø 7 cm Sp 11 cm
Base 5x5 cm



Art. BA526
H 15 cm L 4 cm Sp 8 cm



Art. BA524
H 4 cm L 27 cm Sp 9 cm



Art. BA528
H 44 cm L 14 cm



Art. ST57
Pole: ø 20 mm
Pole: ø 25 mm
Sp 23 cm H 12 cm
Final part 1: H 10 cm L 13 cm
Final part 2: L 4 cm



Art. ST56
Pole: ø 20 mm Sp 11 cm
Final part: H 6 cm L 8 cm



Art. ST55
H 16 cm Sp 13 cm
Murano ball ø 7 cm



Art. BA527
H 43 cm L 22 cm
Enlarge mirror 2X
ø 18 cm

Prince Collection

Specchio da parete in oro 24k con sfere di Murano trasparente-oro

Wall mirror in gold 24k colour with transparent-gold Murano glass spheres



Art. BA529
73 cm x 25 cm
H 101 cm



Art. BA233/wall
H 100 cm L 90 cm

Art. 1773/P
H 17 cm ø 24 cm
2 x E14 x 40W

Art. 1773/G
H 24 cm ø 38 cm
3 x E14 x 40W

Acanto Leaves

Foglie in fusione di ottone dorata creano un classico senza tempo
Cast golden brass leaves create a timeless classic look



Art. BA640
H 19 cm L 9 cm
Sp 9 cm

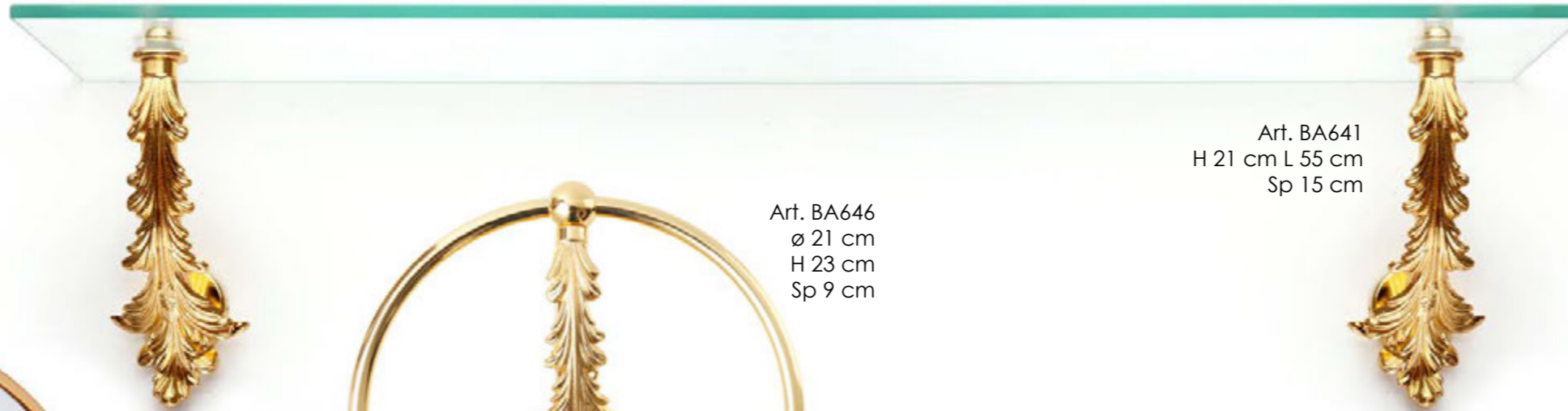

Art. BA641
H 21 cm L 55 cm
Sp 15 cm



Art. BA646
ø 21 cm
H 23 cm
Sp 9 cm

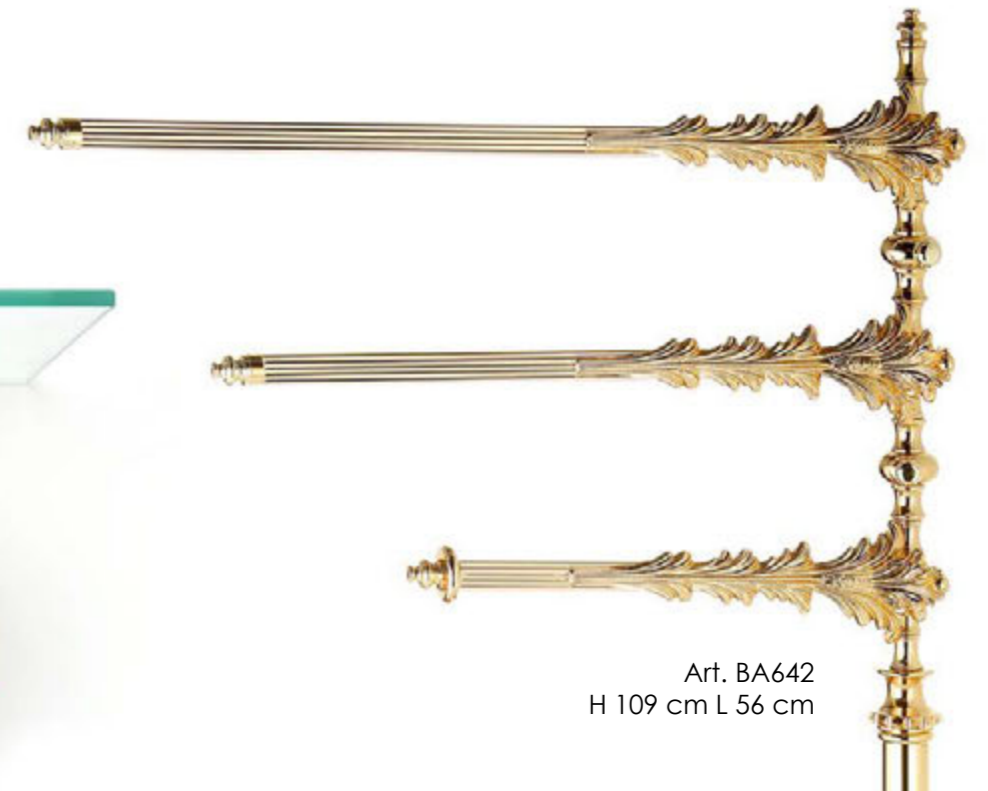

Art. BA642
H 109 cm L 56 cm



Art. BA648
H 48 cm L 22 cm
Enlarge mirror 2X
ø 18 cm



Art. BA645
H 6 cm L 70 cm Sp 10 cm



Art. BA644
H 6 cm L 60 cm Sp 10 cm



Art. BA643
H 6 cm L 51 cm Sp 10 cm



Art. BA647
H 6 cm L 28 cm Sp 10 cm



Sgabelli in fusione
di ottone dorata e imbottito
in eco-pelle di alta artigianalità italiana

*Stools in cast golden brass and padded
faux leather of high Italian craftsmanship*



Art. BA649
H 55 cm L 35x35 cm



Art. BA650
H 55 cm L 58x35 cm





Art. 2106
L 160 x H 120 cm Sp 10
Mirror L 109 x 71 cm
Led 4,5 m strip
Led 3200°K 14,4 W/m

Coffee table in Casting Brass
and Italian Crystals Elements

Art. 2100/Table/P
H 46 cm L 57x58 cm



Eco-leather puff and Swarovski crystals,
structure in Casting Brass and italian
crystals elements

Art. 2100/Pouff/P
H 59 cm L 57x58 cm



Art. 2100/A
H 57 cm Pø 18 cm
Sp 22 cm
1 x E14 x 40W

Art. 2099
H 7 cm L 97 x 49 cm
+ 50 cm steel cable
Ceiling base 30 cm x 8 cm x H 8 cm
Led 3000K Lumen 4649 - 36W



Eco-leather puff and Swarovski crystals,
structure in Casting Brass and Italian
crystals elements

Art. 2100/Pouff/G
H 59 cm L 105x58 cm



Art. 2100/Pouff/G
H 59 cm L 105x58 cm

Art. 1910/A1
H 43 cm L 25 cm Sp 15 cm
1 x E14 x 60W
+ Led SMD bianco freddo
Lumen 60 su Flex Strip 1,07W



Panther

Collezione di corpi illuminanti con animali di puro design in microfusione di ottone smaltata, e bobèches in cristallo italiano trasparente molato a mano

Collection of lighting objects with animals of pure design in micro casting of enameled brass and bobèche in clear Italian hand-cut crystal

Colleция осветительных приборов с животными в уникальном дизайне, созданными с помощью микро-литья латуни, покрытой эмалью, и bobèche из прозрачного итальянского хрусталя, гравированного вручную





Panther

Gioielli da bagno, in microfusione di ottone smaltata, animali di puro design abbinati ed elementi di arredobagno verniciati in oro 24 k

Jewelry for bathroom. The animals are made by micro casting of the brass, enameled and finished in gold 24 carats give a touch of pure design to the accessories

Настоящие драгоценности, созданные при помощи микро плавления латуни, покрытой эмалью и частицами из золота 24 карата, представленные животные являются воплощением дизайна в аксессуарах для ванных комнат



Art. 1911/A1
H 4,5 cm L 25 cm Sp 15 cm
+ Led SMD bianco freddo
Lumen 60 su Flex Strip 1,07W

Art. 1910/G
H 27 cm L 24 cm Sp 4,5 cm
Led SMD bianco freddo
Lumen 120 su Flex Strip 2,14W



Art. 1910/P
H 21 cm L 20 cm Sp 4,5 cm
Led SMD bianco freddo
Lumen 70 su Flex Strip 1,26W

Art. 1910/CH8
H 106 cm ø 97 cm
8 x E14 x 60W + 3 Dicroiche 60W

Art. BA516/wall
H 51 cm L 100 cm





Art. BA480
H 10 cm L 12 cm Sp 13 cm

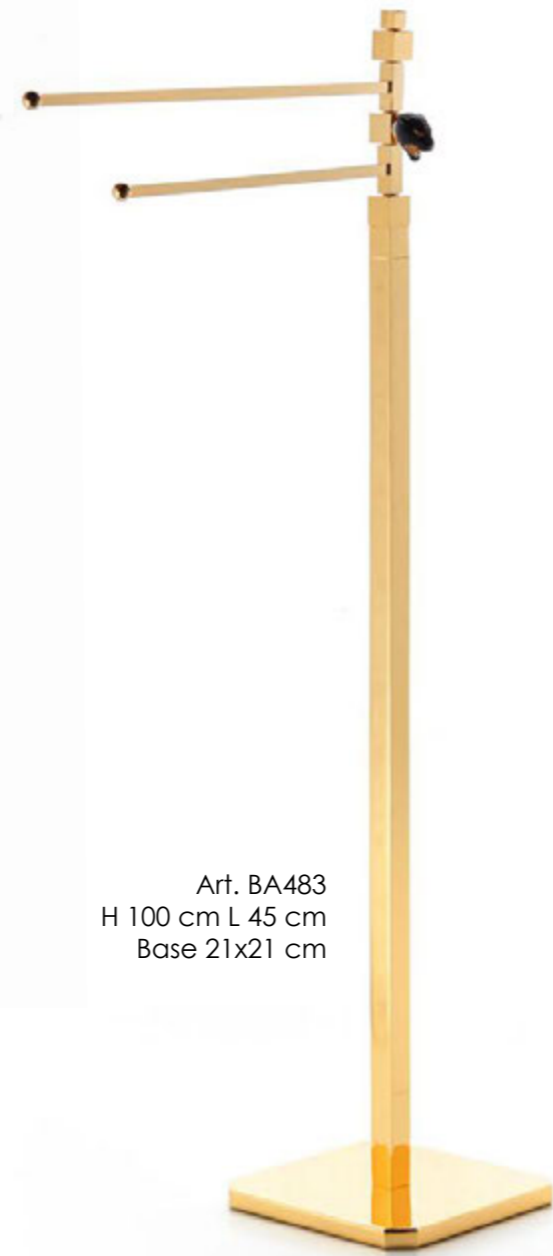

Art. BA483
H 100 cm L 45 cm
Base 21x21 cm



Art. BA485
H 4 cm L 55 cm Sp 21 cm



Art. BA484
H 4 cm L 16 cm Sp 10 cm



Art. BA489
H 21 cm L 13 cm
Sp 10 cm



Art. BA488
H 40 cm L 8x8 cm



Art. BA481
H 4 cm L 50 cm Sp 12 cm



Art. BA482
H 4 cm L 40 cm Sp 12 cm



Art. BA487
H 22 cm L 45 cm Sp 10 cm



Art. BA491/wall
H 45 cm ø 18 cm
Sp min 9 cm Sp max 58 cm
Enlarge mirror 2X
ø 18 cm



Art. ST48
Double-pole: ø 25 mm
Tube: 8x8 cm
H 34 cm Sp max 31 cm
Final part 1: 4 cm
Final part 2: 3 cm



Art. ST47
L 4x4 cm Sp 10 cm



Art. BA486
H 40 cm L 22 cm
Enlarge table
mirror 2X
ø 18 cm

Art. BA660 Towel holder
H 26 cm L 46 Sp 9 cm

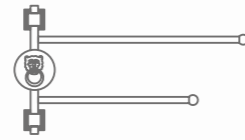

Art. BA657 Towel holder
H 8 cm L 50 Sp 9 cm



Art. BA658 Towel holder
H 8 cm L 40 Sp 9 cm



Art. BA655 Towel holder
L 13 cm H 23 cm Sp 9 cm



Art. BA661 Hanger
H 8 cm L 16 cm Sp 9 cm



Art. BA662 Shelf
H 8 cm L 55 cm Sp 20 cm



Art. BA656 Toilet paper holder
H 13 cm L 12 cm Sp 13 cm



Art. BA663 Table
H 40 cm L 22 cm
Table mirror 2X
ø 18 cm



Art. BA664/wall
H 47 cm ø 18 cm
Sp min 9 cm Sp max 58 cm
Enlarge wall mirror 2X

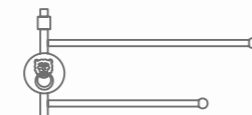
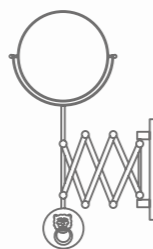

Art. BA659 Towel holder
H 103 cm L 53 cm
Base 21x21 cm



Art. BA665 Toilet brush
H 40 cm L 8x8 cm



Lions

Accessori da bagno con medaglioni in vetro trasparente ed elementi in fusione di ottone dorata

Bathroom accessories with clear glass medallions and elements in cast golden brass

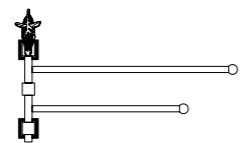

Art. BA544 Towel holder
H 27 cm L 45 cm Sp 10 cm



Art. BA541 Towel holder
H 10 cm L 50 cm Sp 12 cm



Art. BA542 Towel holder
H 10 cm L 40 cm Sp 12 cm

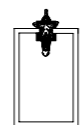

Art. BA550 Towel holder
H 24 cm L 13 cm Sp 10 cm



Art. BA545 Hanger
H 10 cm L 16 cm Sp 10 cm

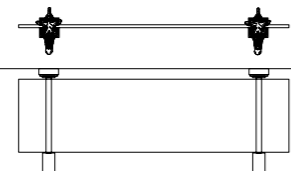

Art. BA546 Shelf
H 10 cm L 55 cm Sp 21 cm

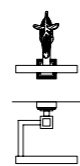

Art. BA540 Toilet paper holder
H 14 cm L 12 cm Sp 13 cm



Art. BA547 Table
H 40 cm L 22 cm
Enlarge table mirror 2X
ø 18 cm

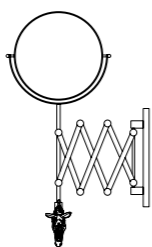

Art. BA548/wall
H 48 cm ø 18 cm
Sp min 9 cm Sp max 58 cm
Enlarge mirror 2X



Art. BA543 Towel holder
H 108 cm L 45 cm
Base 21x21 cm

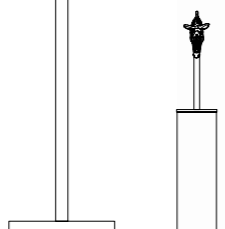

Art. BA549 Toilet brush
H 45 cm L 8x8 cm

Art. BA545 Hanger
H 10 cm L 16 cm Sp 10 cm



Zebra

Animali di puro design in micro fusione di ottone smaltata abbinati ad elementi in ottone oro 24 carati

Animals of pure design made by micro casting brass combined with elements of brass gold 24 carats

Настоящие драгоценности, созданные при помощи микро плавления латуни, покрытой эмалью и частицами из золота 24 карата, представленные животные являются воплощением дизайна в аксессуарах для ванных комнат



Art. 1596
H 85 cm Pø 45 cm
1 x E27 x 60W

Owl

Gioielli da bagno, in microfusione di ottone smaltata, animali di puro design abbinati ed elementi di arredobagno verniciati in oro 24 k

Jewelry for bathroom. The animals are made by micro casting of the brass, enameled and finished in gold 24 carats give a touch of pure design to the accessories

Настоящие драгоценности, созданные при помощи микро плавления латуни, покрытой эмалью и частицами из золота 24 карата, представленные животные являются воплощением дизайна в аксессуарах для ванных комнат





Art. BA400
H 26 cm ø 20 cm

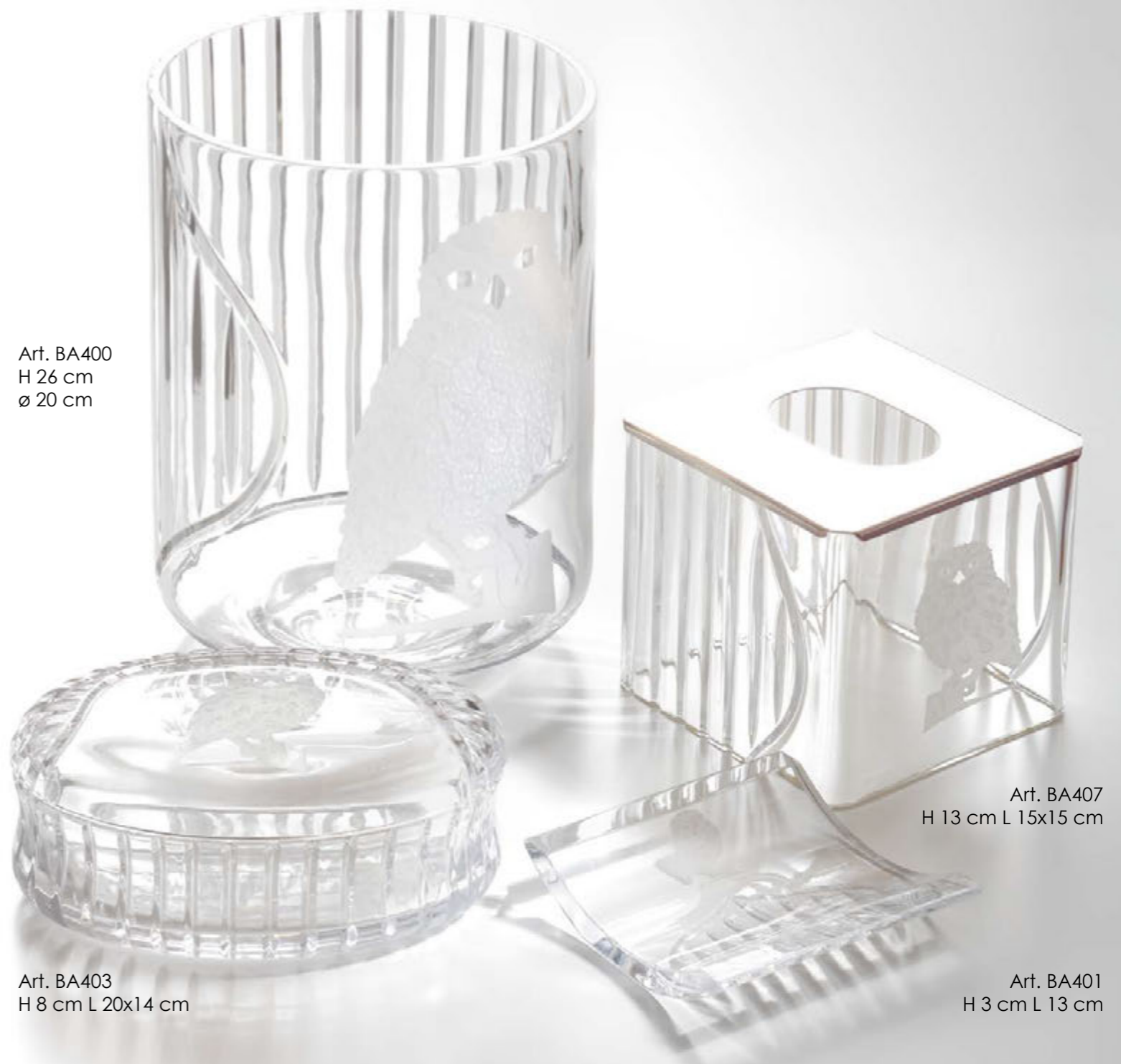

Art. BA400
H 26 cm
ø 20 cm

Art. BA403
H 8 cm L 20x14 cm

Art. BA407
H 13 cm L 15x15 cm

Art. BA401
H 3 cm L 13 cm



Art. BA402
H 2 cm L 36x15 cm

Owl

Set in cristallo italiano trasparente
inciso interamente a mano con
figura di civetta

Set in clear Italian crystal cut
entirely by hand with the figure
of an owl

Набор из прозрачного
итальянского хрусталя,
гравированного полностью
вручную, с фигурой совы



Art. BA403
H 8 cm L 20x14 cm



Art. BA405
H 18 cm ø 8 cm

Art. BA404
H 12 cm ø 8 cm



Art. BA406/wall
H 21 cm L 23 cm Sp 12 cm

Owl

Set in cristallo italiano trasparente
inciso interamente a mano con
figura di civetta

*Set in clear Italian crystal cut
entirely by hand with the figure
of an owl*

Набор из прозрачного
итальянского хрусталя,
гравированного полностью
вручную, с фигурой совы



Art. BA401
H 3 cm L 13 cm

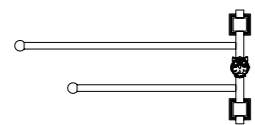

Art. BA555 Towel holder
H 22 cm L 45 cm Sp 10 cm



Art. BA552 Towel holder
H 4 cm L 50 cm Sp 12 cm

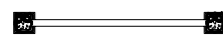

Art. BA553 Towel holder
H 4 cm L 40 cm Sp 12 cm

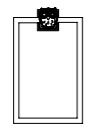

Art. BA561 Towel holder
H 21 cm L 13 cm Sp 12 cm



Art. BA556 Hanger
H 4 cm L 16 cm Sp 10 cm



Art. BA557 Shelf
H 4 cm L 55 cm Sp 21 cm

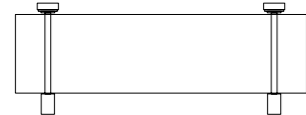

Art. BA551 Toilet paper holder
H 10 cm L 12 cm Sp 13 cm

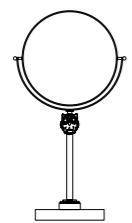
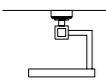

Art. BA558 Table
H 40 cm L 22 cm
Enlarge table mirror 2X
Ø 18 cm

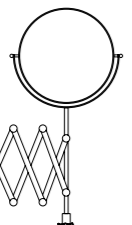

Art. BA559/wall
H 44 cm Ø 18 cm
Sp min 9 cm Sp max 58 cm
Enlarge mirror 2X

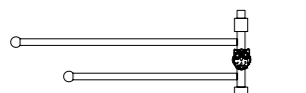

Art. BA554 Towel holder
H 100 cm L 45 cm
Base 21x21 cm

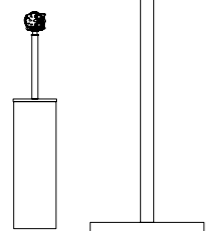

Art. BA560 Toilet brush
H 40 cm L 8x8 cm



Owl

Gioielli da bagno, in microfusione di ottone smaltata, animali di puro design abbinati ed elementi di arredobagno verniciati in oro 24 K

Jewelry for bathroom. The animals are made by micro casting of the brass, enameled and finished in gold 24 carats give a touch of pure design to the accessories

Настоящие драгоценности, созданные при помощи микро плавления латуни, покрытой эмалью и частицами из золота 24 карата, представленные животные являются воплощением дизайна в аксессуарах для ванных комнат

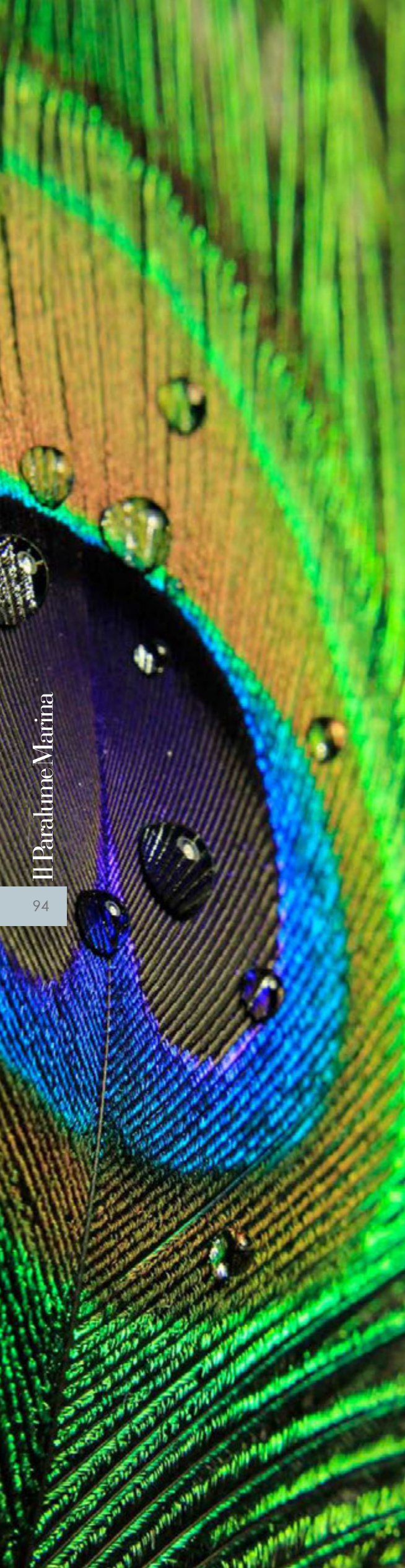

Peafowl

Set in cristallo italiano trasparente inciso interamente a mano con figura di piuma di pavone

Set in clear Italian crystal cut entirely by hand with engraved peacock feather

набор из прозрачного итальянского хрусталя, гравированного полностью вручную, с пером павлина.



Art. BA428
H 2 cm L 36x15 cm



Art. BA429/wall
H 13 cm Sp 9 cm

Art. BA430/wall
H 18 cm Sp 9 cm



Art. BA426
H 26 cm ø 20 cm

Art. BA431
H 8 cm L 20x14 cm

Art. BA430
H 18 cm L 8x8 cm

Art. BA429
H 13 cm L 8x8 cm

Art. BA586
H 15 cm L 13x13 cm

Art. BA428
H 2 cm L 36x15 cm

Art. BA427
H 3 cm L 13 cm

Art. BA585 Towel holder
H 23 cm L 13 cm Sp 8 cm

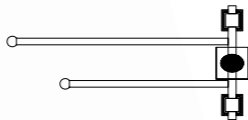

- 

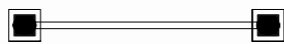
Art. BA579 Towel holder
H 22 cm L 45 cm Sp 8 cm
- 

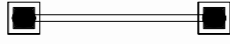
Art. BA576 Towel holder
H 6 cm L 50 cm Sp 10 cm
- 

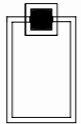
Art. BA577 Towel holder
H 6 cm L 40 cm Sp 10 cm
- 

Art. BA585 Towel holder
H 23 cm L 13 cm Sp 8 cm
- 

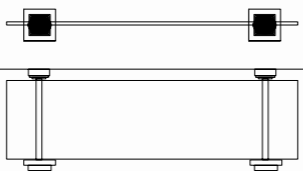
Art. BA580 Hanger
H 6 cm L 16 cm Sp 8 cm
- 

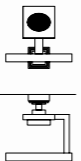
Art. BA581 Shelf
H 6 cm L 55 cm Sp 19 cm
- 

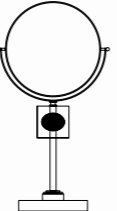
Art. BA575 Toilet paper holder
H 12 cm L 12 cm Sp 10 cm
- 

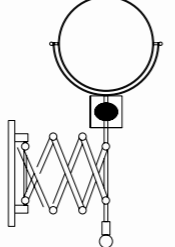
Art. BA582 Table
H 40 cm L 22 cm
Enlarge table mirror 2X
ø 18 cm
- 

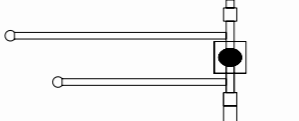
Art. BA583/wall
H 48 cm ø 18 cm
Sp min 9 cm
Sp max 58 cm
Enlarge mirror 2X
- 

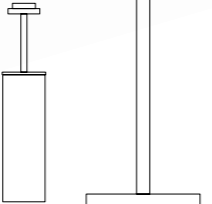
Art. BA578 Towel holder
H 100 cm L 45 cm
Base 21x21 cm
- 

Art. BA584 Toilet brush
H 38 cm L 8x8 cm



Agata fuxia



Agata gialla

Peafowl

Medaglie di agata, stravaganti ed elegantemente difformi accompagnano questa collezione variopinta di accessori da bagno in ottone verniciato oro 24 K

Extravagant medals made of agate distinguish this bright multicolor set of accessories in brass gold 24 carats

Экстравагантные, причудливых форм и оттенков, медали из агата являются центральным элементом этой богатой красками коллекции аксессуаров, выполненных в отделке латуни золото 24 карата





Art. BA467
H 40 cm L 22 cm
Enlarge table mirror 2X
ø 18 cm



Art. BA458
H 33 cm ø 22 cm

Art. BA460
H 20 cm ø 16 cm

Art. BA455
H 46 cm ø 8,5 cm



Art. BA457/BR
H 14 cm ø 6,5 cm

Art. BA456/BR
H 18 cm ø 6,5 cm

Python

Il tubo diamantato brunito e l'ottone bocciardato creano suggestioni naturali ricercate, che, accompagnati da elementi di cristallo Swarovski rendono la composizione elegantemente dinamica

Diamond cut and hammered brass in brunito color along with Swarovski crystals make the composition elegant and dynamic

Динамична и елегантна серия с използването на метал с алмазна резка и гравирания латуни. Кристали Swarovski придават изделиям още повече яркост и блеска



Art. BA452
H 7 cm L 50 cm Sp10 cm

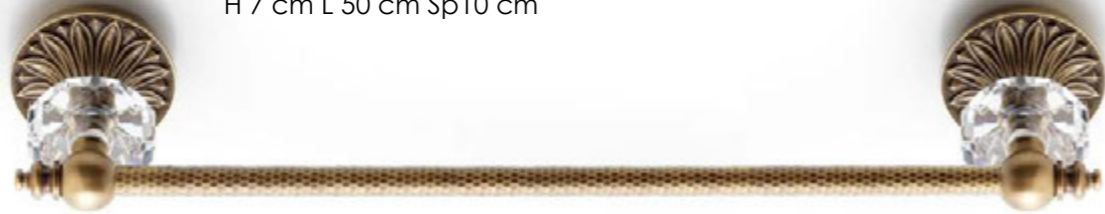

Art. BA451
H 7 cm L 35 cm Sp10 cm



Art. BA453
H 28 cm L 45 cm Sp 10 cm



Art. BA468
H 114 cm L tot. 60 cm

Python

Il tubo diamantato brunito e l'ottone bocciardato creano suggestioni naturali ricercate, che, accompagnati da elementi di cristallo Swarovski rendono la composizione elegantemente dinamica

Diamond cut and hammered brass in brunito color along with Swarovski crystals make the composition elegant and dynamic

Динамична и елегантна серия с използването на метал с алмазна резка и гравированна латуни. Кристали Swarovski придават изделиям още повече яркост и блеска



Art. BA454
H 24 cm ø 22 cm
Sp 10 cm



Art. BA459
H 7 cm L 13 cm Sp10 cm



Art. BA688
H 7 cm L 17 cm Sp 14 cm

Art. BA450
H 7 cm L 20 cm Sp10 cm

Art. BA466
H 14 cm ø 6,5 cm

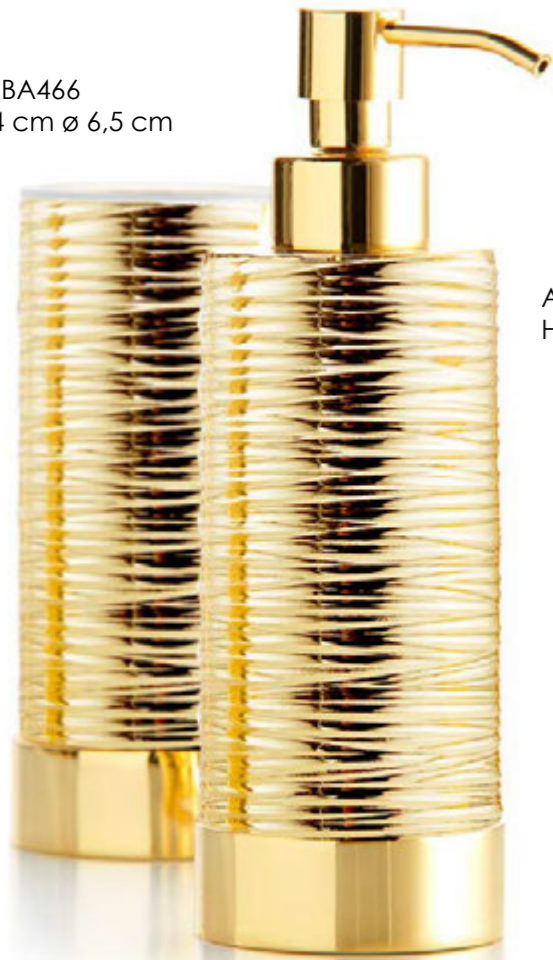

Art. BA465
H 18 cm ø 6,5 cm



Art. BA456
H 18 cm ø 6,5 cm

Art. BA457
H 14 cm ø 6,5 cm

Art. BA635
H 38 cm ø 8 cm



Art. BA636
H 31 cm ø 22 cm

Art. BA637
H 18 cm ø 16 cm



Art. BA461
H 34 cm ø max 30 cm



Art. BA462
H 34 cm ø max 30 cm



Art. BA463
H 34 cm ø max 30 cm

Set Kr Diamante

Specchio da parete cromato
con elementi di cristallo Swarovski

Wall mirror in chrome colour
with Swarovski crystal elements



Art. BA201/wall
H 100 cm L 81 cm



Art. BA202/wall
H 47 cm ø 18 cm
Enlarge mirror 2X
Sp min 9 cm
Sp max 58 cm



Art. BA223
H 174 cm ø 34 cm
Enlarge mirror 2X
ø 30 cm



Set Diamante

Ottone e cristallo Swarovski / Brass and Swarovski crystal



Art. BA111
H 6 cm L 50 cm Sp 8 cm



Art. BA113
H 26 cm L 45 cm Sp 8 cm



Art. BA116
H 32 cm ø 22 cm



Art. BA110
H 7 cm L 20 cm Sp 10 cm

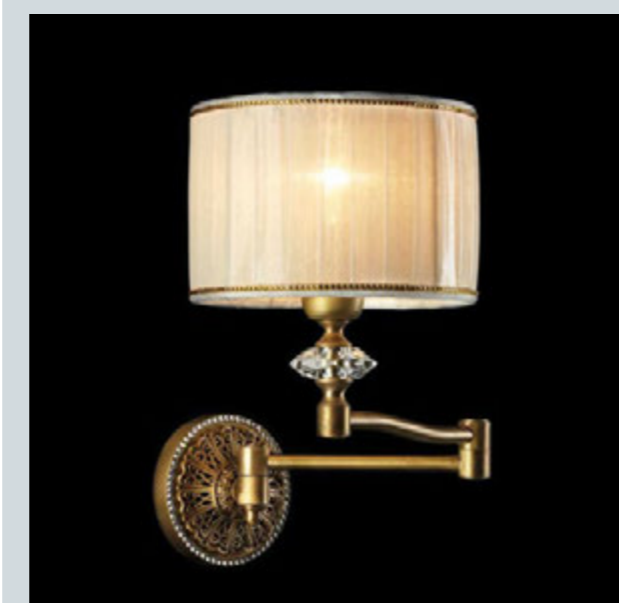

Art. 1428
H 28 cm Pø 18 cm
1 x E14 x 40W



Art. BA114
H 23 cm ø 21 cm Sp 8 cm

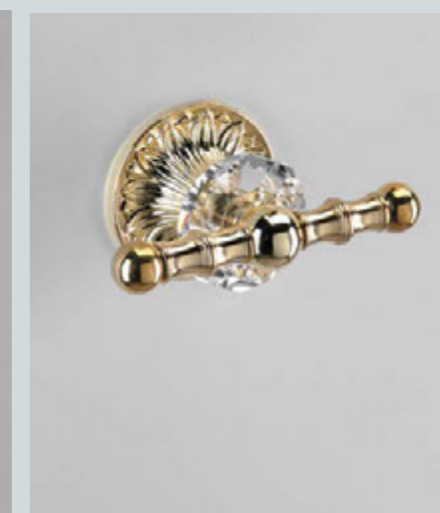

Art. BA112
H 7 cm L 13 cm Sp 8 cm

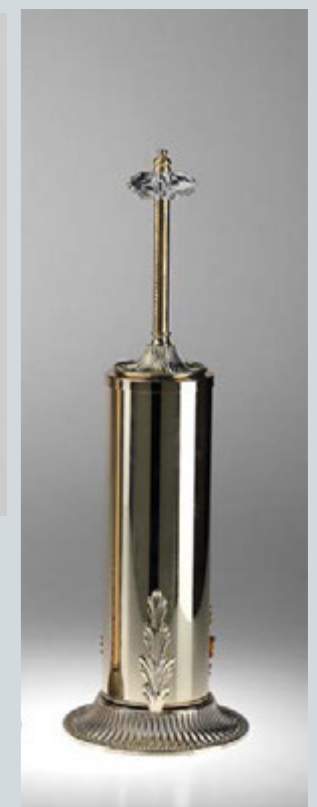

Art. BA115
H 48 cm ø 14 cm



Set Occhio di Tigre

Lampadario in vetro di Murano trasparente e bobeches in ottone cromato con incastonati Swarovski Elements; paralumi in seta bianca lucida e passamaneria barocca argento

Chandelier made of Murano transparent glass and chrome plated brass bobeches embedded with Swarovski Elements; lampshades are made of shiny white silk with baroque silver trimming

Люстра из муранского стекла и bobeches из хромированной латуни с кристаллами Swarovski Elements; абажуры выполнены из глянцевого белого шелка с серебряной оборкой барокко.



Art. 1770/CH18
H 102 cm ø 144 cm
Pø 12 cm
18 x E14 x 40W

design: Arch. Federica Vicentini
"International Design Registration N°: DM/079817"



Set Occhio di Tigre

Set in ottone cromato con incastonati Swarovski Elements

Bathroom set made on chrome-plated brass with Swarovski Elements

Art. BA207/ABS
H 13 cm L 13x13 cm

Art. BA320
H 11 cm ø 6 cm

Art. BA321
H 16 cm ø 6 cm

Art. BA208/ABS
H 2,5 cm L 10x14 cm

Art. BA209
H 1 cm ø 10 cm

Set Occhio di Tigre

Set in ottone cromato con incastonati Swarovski Elements

Bathroom set made on chrome-plated brass with Swarovski Elements

Art. BA208/wall/ABS
H 2,5 cm L 10x14 cm

Art. BA211/wall
H 16 cm ø 6 cm

Art. BA205/wall
H 11 cm ø 6 cm

Art. BA206
H 27 cm ø 22 cm

Art. BA210/wall
H 36 cm ø 8 cm

Set Occhio di Tigre



Art. BA203
H 40 cm L 22 cm
Enlarge table mirror 2X
ø 18 cm



Art. BA254/wall/BIS
H 36 cm L 8x8 cm



Art. BA255
H 27 cm ø 22 cm

Set Zaffiro

Specchio da parete cromato
con inserti quadrati Swarovski

Wall mirror in chrome colour
with square Swarovski inserts



Art. BA247/wall
H 51 cm L 100 cm



Art. BA256/ABS
H 13 cm L 13x13 cm

Art. BA253/BIS
H 11 cm L 7x7 cm



Art. BA251
H 1,5 cm L 10x10 cm



Art. BA257/ABS
H 2,5 cm L 10x14 cm



Art. BA250/wall/BIS
H 16 cm L 7x7 cm



Art. BA252/BIS
H 16 cm L 7x7 cm

Set Zaffiro

Set da bagno in ottone cromato
con inserti quadrati Swarovski

Bathroom set in chrome brass
with square Swarovski inserts



Art. ST38
Curtain rod with Swarovski elements
Sp max 23 cm
Final part: 13 cm



Art. ST39
L 7,5x7,5 cm
Sp 18 cm



Art. BA692
H 12 cm L 13 cm Sp 20 cm



Art. BA249
H 40 cm L 22 cm
Mirror ø 18 cm

Set Zaffiro



Art. BA248/wall
H 43 cm ø 18 cm
Sp min 9 cm
Sp max 58 cm

Set Zaffiro

Ottone cromato con inserto Swarovski / Chrome brass with a Swarovski insert

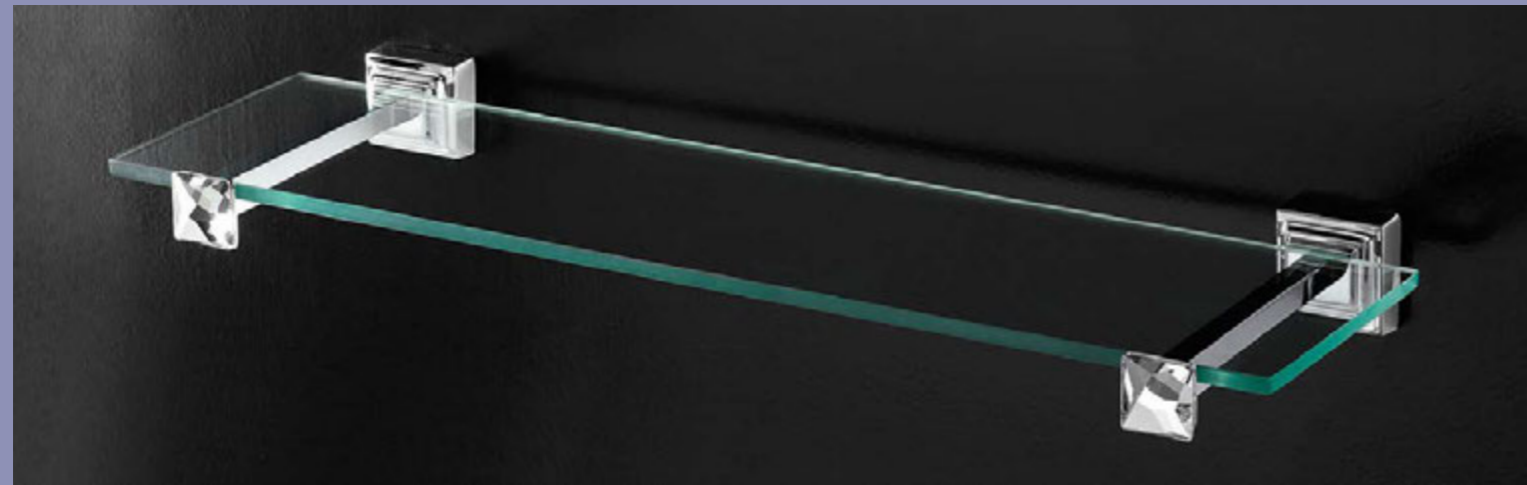

Art. BA122
H 4 cm L 55 cm Sp 15 cm



Art. BA118
H 17 cm L 45 cm Sp 6 cm



Art. BA120
H 100 cm L 45 cm
base 21x21 cm



Art. BA117
H 4 cm L 12 cm Sp 13 cm



Art. BA121
H 4 cm L 18 cm Sp 6 cm



Art. BA119
H 21 cm L 13 cm Sp 8 cm



Art. 1425/A
H 44 cm Pø 44 cm Sp 18 cm
1 x E27 x 60W



Set Gemma

Ottone con elementi in vetro
Murano "oliva" trasparente

Brass with clear Murano
glass elements "olive"

Art. BA375
H 8 cm L 55 cm Sp 10 cm

Art. BA370
H 28 cm L 45 cm Sp 7 cm

Art. BA371
ø 21 cm Sp 10 cm

Art. BA376
H 40 cm L 22 cm
Mirror ø 18 cm

Art. BA372
H 8 cm L 24 cm Sp 10 cm

Art. BA374
H 45 cm ø 14 cm



Art. BA373
H 8 Sp 10 cm



Art. 1775/A
 H 35 cm L 32 cm
 Sp 15 cm
 4 x G9 x 25W

Set Fiore

Lampadario in finitura oro vecchio con file di perle di vetro trasparenti e fiori di vetro di Murano bianco.

Chandelier finished old-gold with transparent pearls and white Murano glass flowers.



Art. 1775/CH6
 H 148 cm ø 76 cm
 10 x E27 x 60W



Art. BA286
H 32 cm L 50 cm Sp 12 cm



Art. BA283
H 10 cm L 14 cm
Sp 14 cm



Art. BA284
H 10 cm L 24 cm Sp 14 cm



Art. BA287
H 10 cm L 56 cm Sp 14 cm

Set Fiore

Ottone e fiori in vetro Murano
Brass and Murano glass flowers



Art. ST45/2
H 15 cm
Final part: 12 cm
Sp 20 cm



Art. BA282
H 26 cm ø 21 cm Sp 14 cm



Art. BA285
H 48 cm ø 14 cm

Set Ametista

Lampadario con elementi di fusione di ottone cromato e rose pinzate di cristallo italiano finito con paralumi in organza viola e passamaneria Swarovski

Chandelier made of the elements fused in chromed brass and Italian crystal roses clamped by hand. The lampshades are in violet organza with pearls and transparent crystals on the trimming



Art. 1774/CH12
H 85 cm ø 110 cm
Pø 14 cm
12 x E14 x 25W
light on



Art. BA264/wall
H 100 cm L 83 cm



Specchio da parete cromato
con rose pinzate a mano
Wall mirror in chrome colour with
crystal roses clamped by hand

Set Ametista



Art. 1774/A1
H 43 cm Sp 18 cm
Pø 14 cm
1 x E14 x 40W
light off



Art. BA299
H 40 cm L 22 cm
Mirror ø 18 cm

Art. BA266
H 40 cm L 22 cm
Mirror ø 18 cm

Art. BA249
H 40 cm L 22 cm
Mirror ø 18 cm

Set Ametista



Art. BA265/wall
H 47 cm ø 18 cm
Sp min 9 cm
Sp max 58 cm

Set Ametista

Ottone cromato con rosa in cristallo pinzato a mano / Chrome brass with a crystal rose hand-made-stapled



Art. BA124
H 7 cm L 55 cm Sp 12 cm



Art. BA130
H 23 cm L 45 cm Sp 12 cm



Art. BA129
H 48 cm ø 14 cm



Art. BA125
H 7 cm L 23 cm Sp 12 cm



Art. BA127
H 8 cm L 6 cm



Art. BA126
H 24 cm ø 21 cm Sp 13 cm



Art. 1577
H 35 cm Pø 16 cm Sp 17 cm
1 x E14 x 40W



Set Topazio

Ottone oro vecchio con sfera trasparente oro / Old-gold brass with gold-crystal sphere



Art. BA102
H 6 cm L 55 cm Sp 8 cm



Art. BA105
H 26 cm L 45 cm Sp 7 cm



Art. BA108
H 18 cm ø 10 cm

Art. BA109
H 13 cm ø 10 cm



Art. BA106
H 107 cm L 45 cm

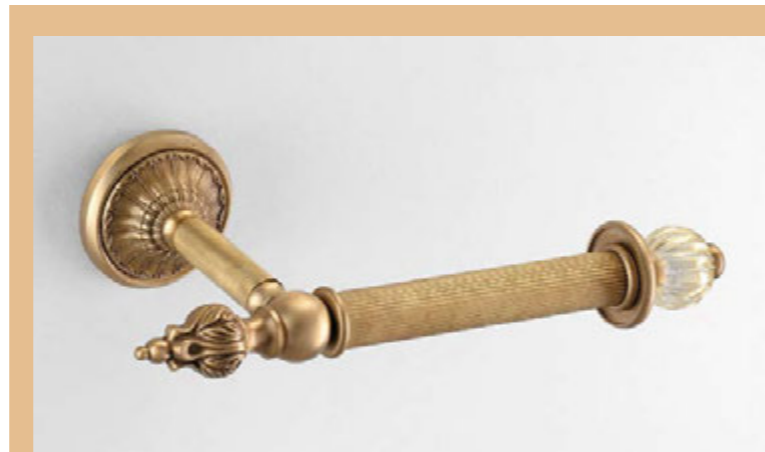

Art. BA101
H 6 cm L 24 cm Sp 12 cm

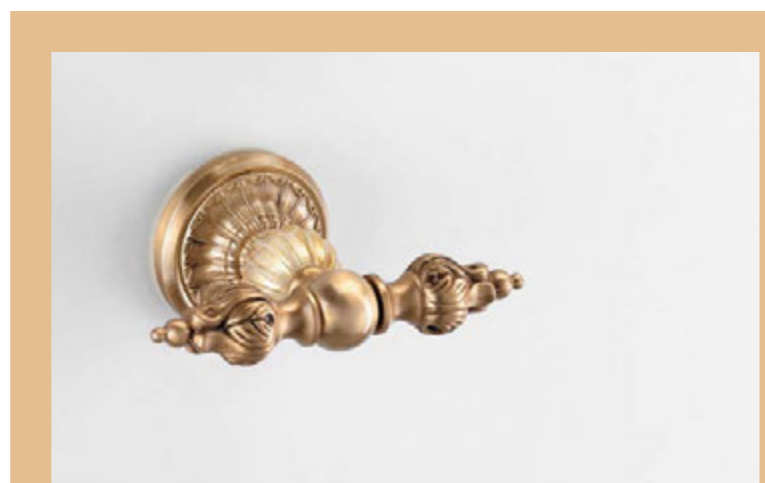

Art. BA104
H 6 cm L 13 cm Sp 8 cm

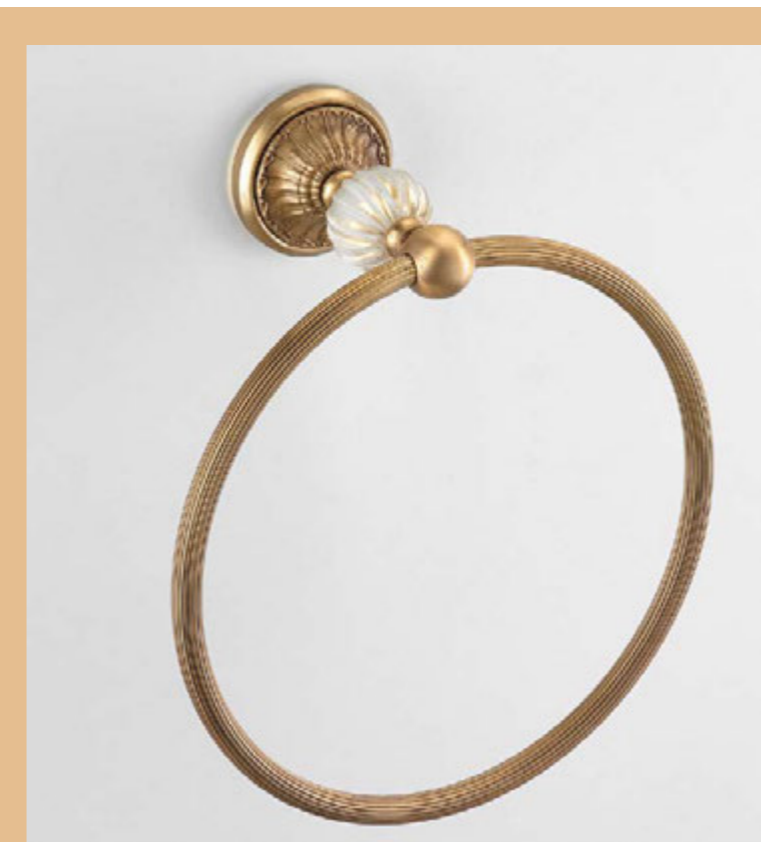

Art. BA103
ø 21 cm Sp 8 cm



Art. BA107
H 48 cm ø 14 cm

Set Acqua Marina

Ottone oro vecchio / Old-gold brass

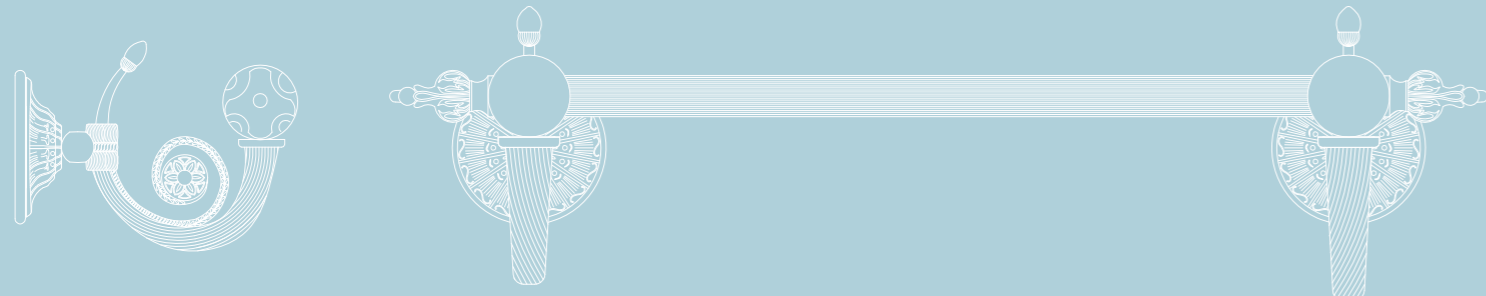

Art. BA136
H 10 cm L 55 cm Sp 12 cm



Art. BA135
H 85 cm L 60x30 cm



Art. BA134
H 9 cm L 23 cm Sp 13 cm

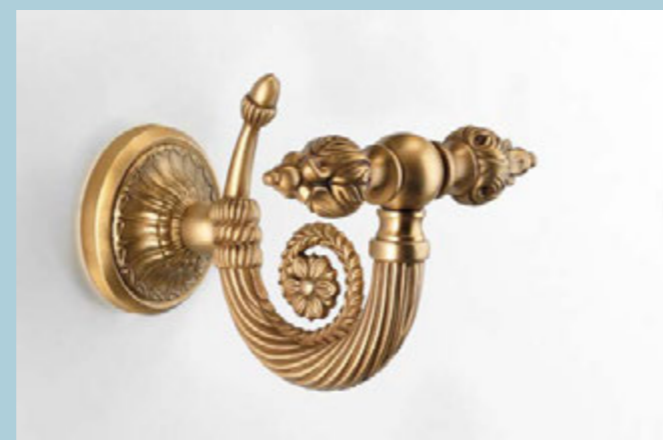

Art. BA133
H 9 cm L 12 cm Sp 13 cm



Art. 1578
H 32 cm Pø 14 cm
Sp 13 cm
1 x E14 x 40W



Art. BA290
Mirror
H 100x80 cm



Art. BA131
ø 21 cm Sp 13 cm



Art. BA128
H 48 cm ø 14 cm

Set Smeraldo

Ottone oro vecchio / Old-gold brass



Art. BA138
H 6 cm L 50 cm Sp 9 cm

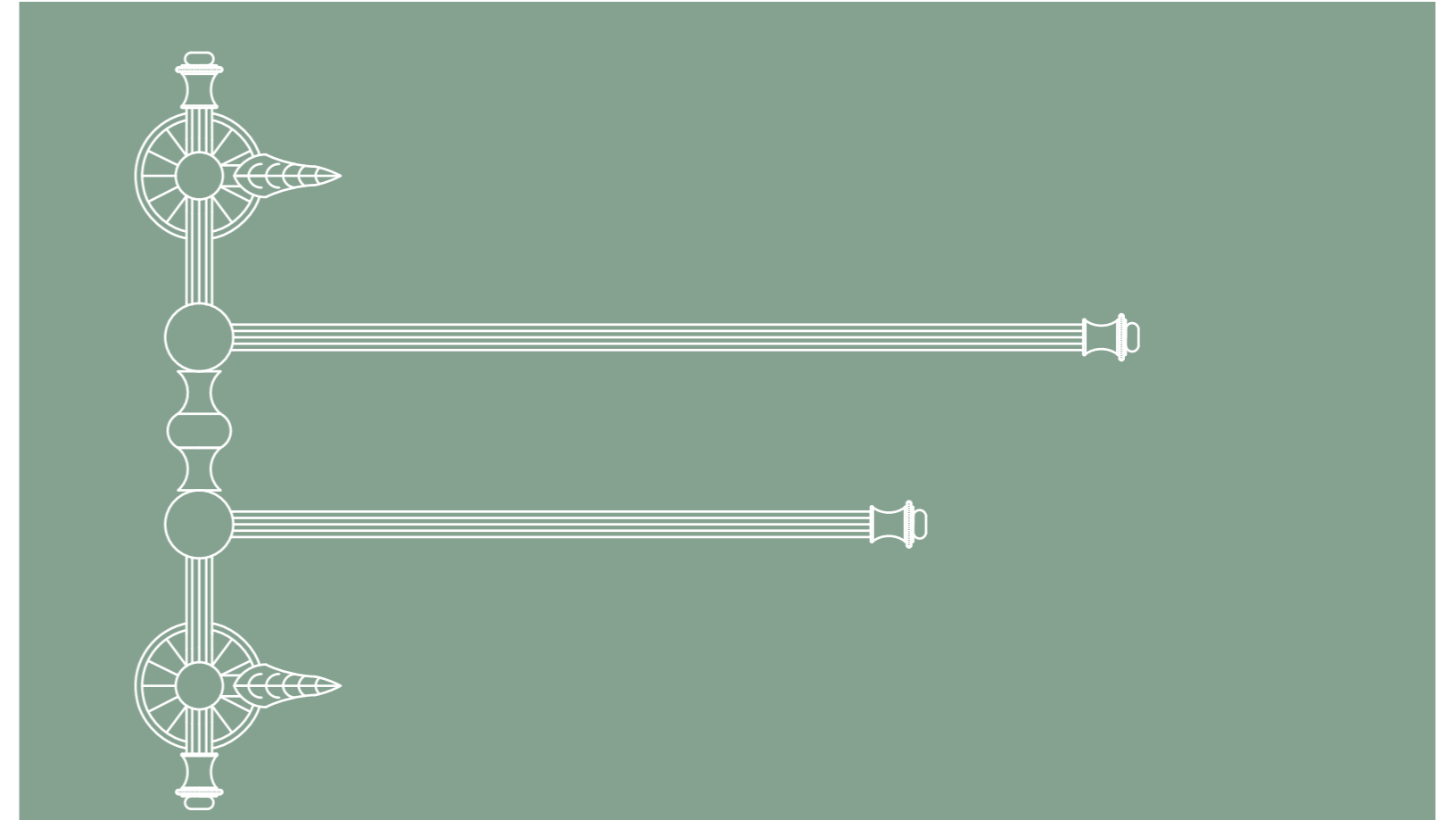

Art. BA142
H 30 cm L 45 cm Sp 5 cm

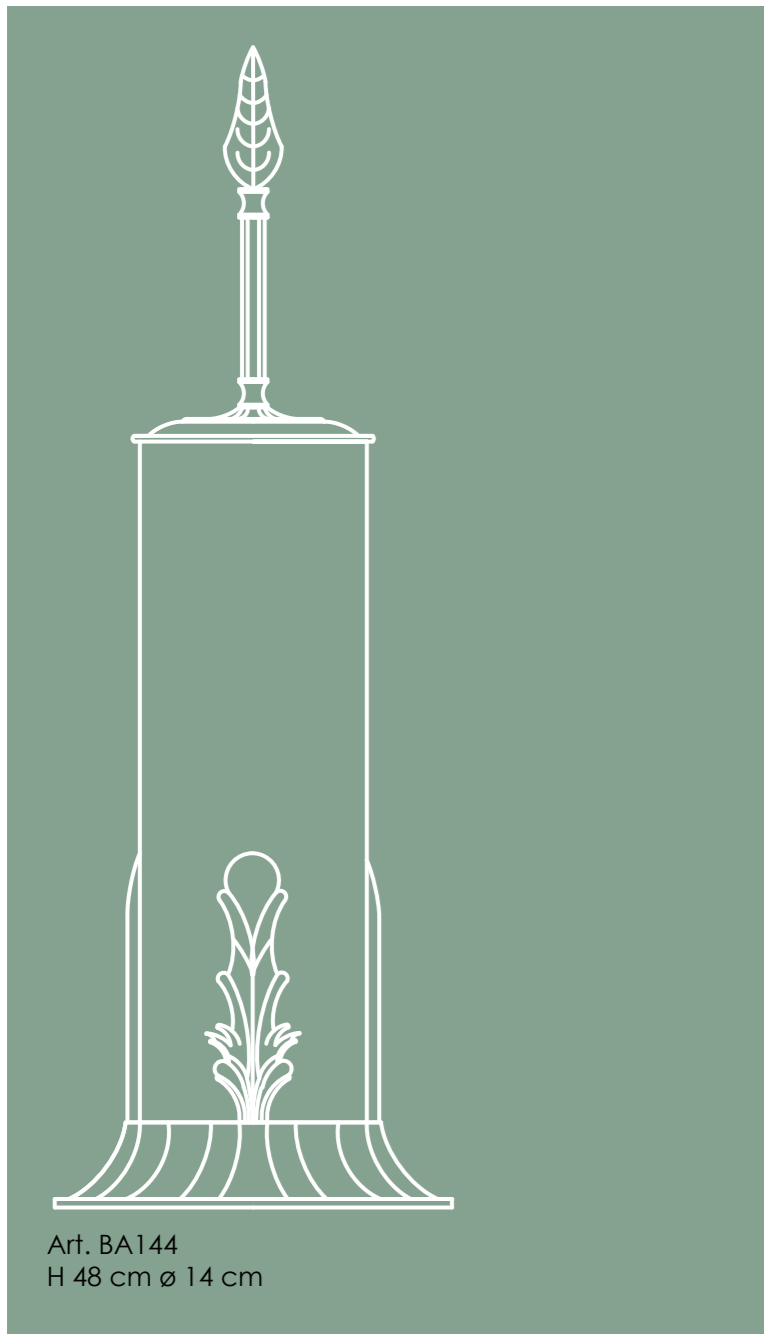

Art. BA144
H 48 cm ø 14 cm



Art. BA141
H 6 cm L 22 cm Sp 15 cm

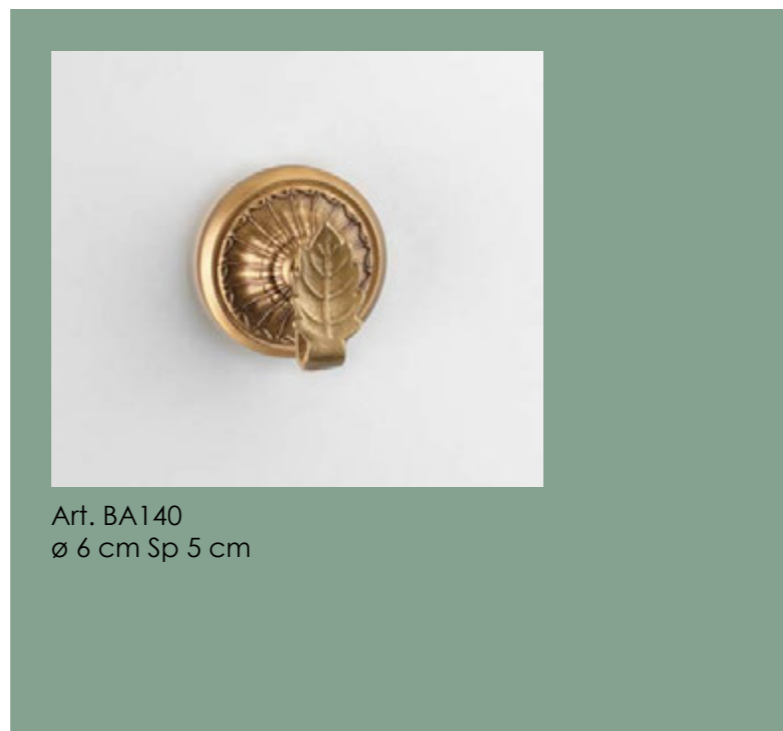

Art. BA140
ø 6 cm Sp 5 cm



Art. BA143
ø 21 cm Sp 9 cm

Set Rubino

Ottone oro vecchio con elemento in fusione smaltato / Old-gold brass with roses on fusion's brass glazed



Art. BA145
H 6 cm L 50 cm Sp 11 cm

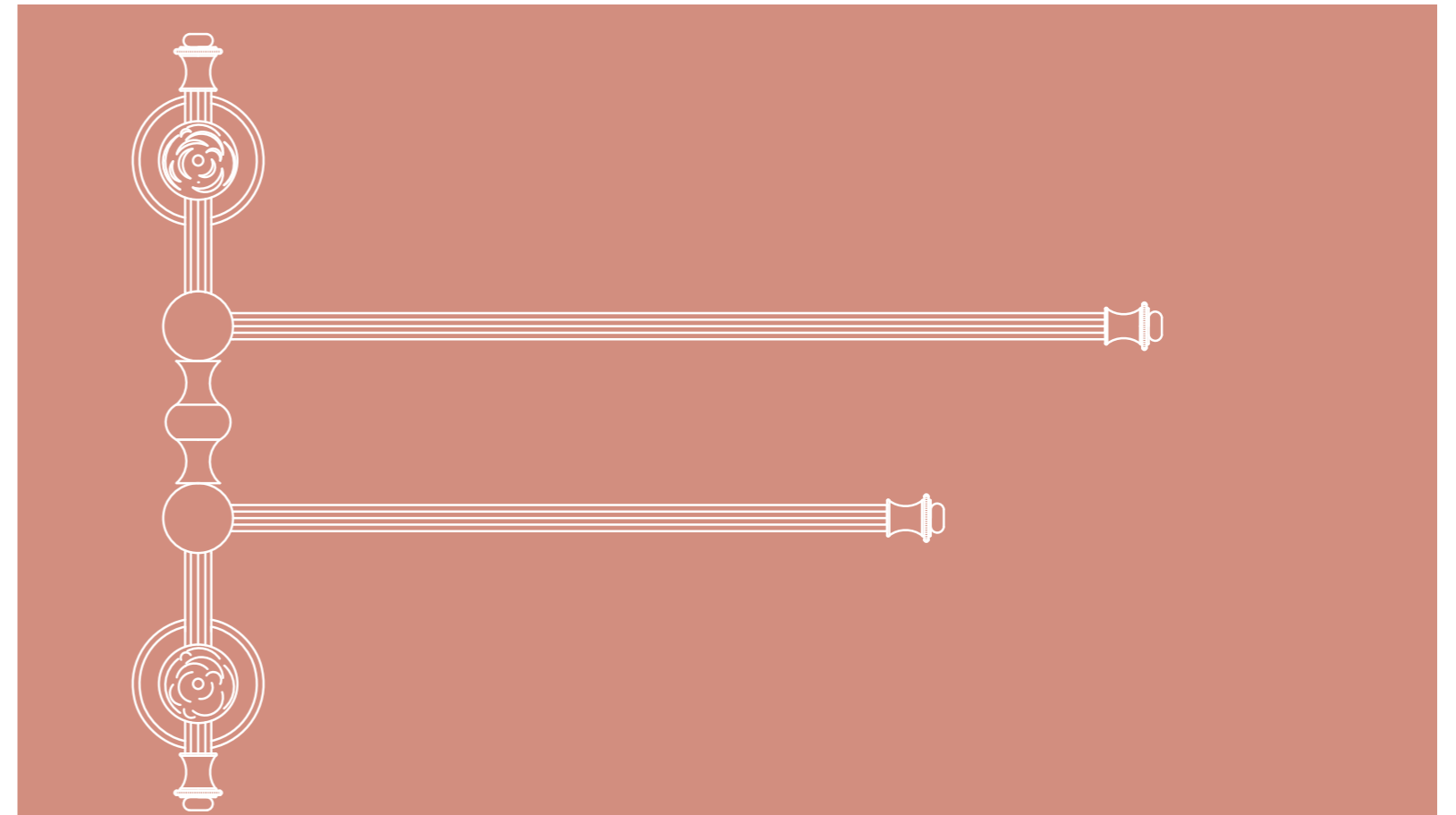

Art. BA150
H 29 cm L 45 cm Sp 7 cm

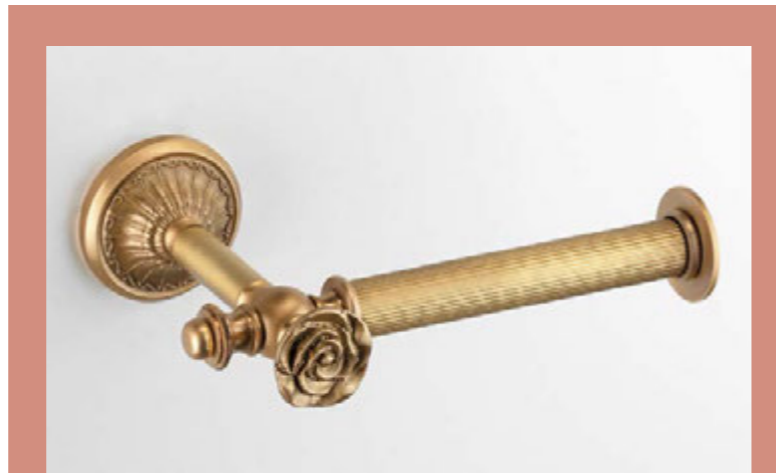

Art. BA146
H 6 cm L 20 cm Sp 14 cm

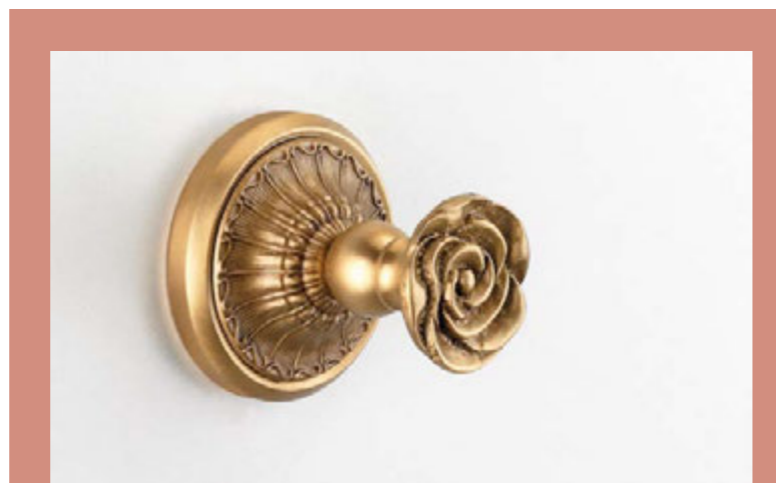

Art. BA147
H 6 cm Sp 7 cm

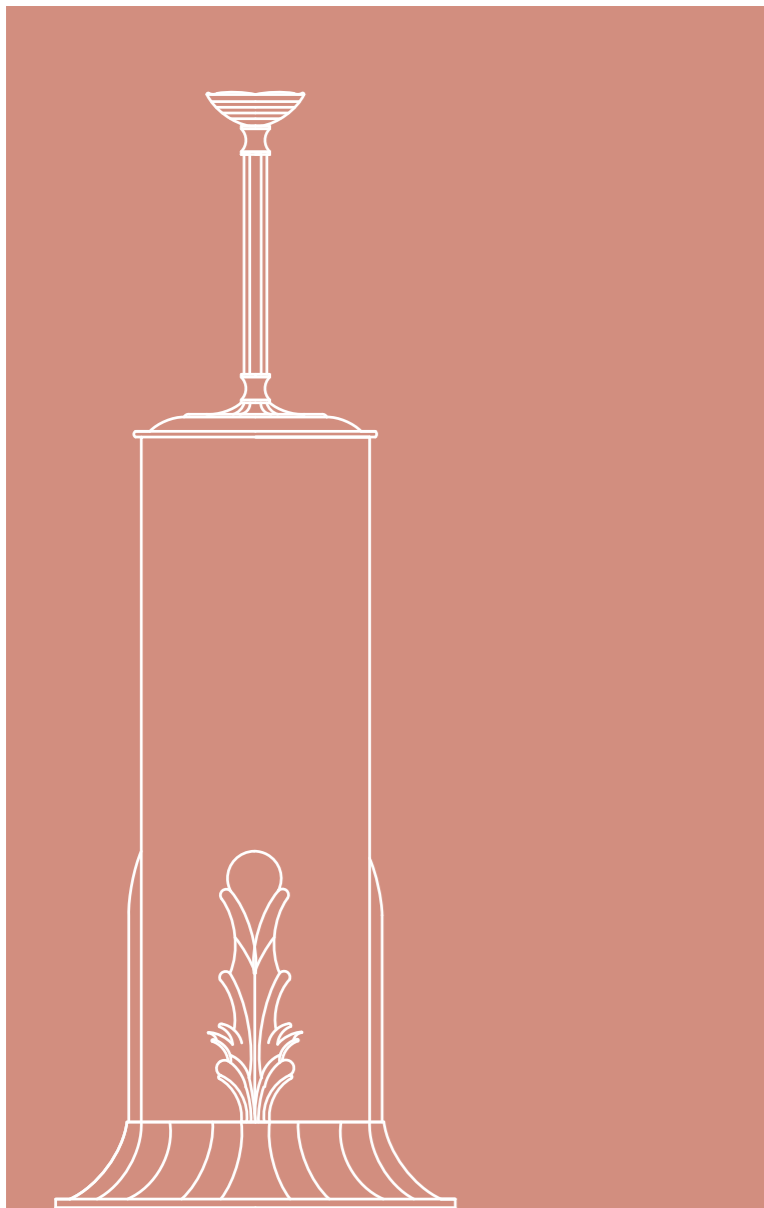

Art. BA151
H 48 cm ø 14 cm

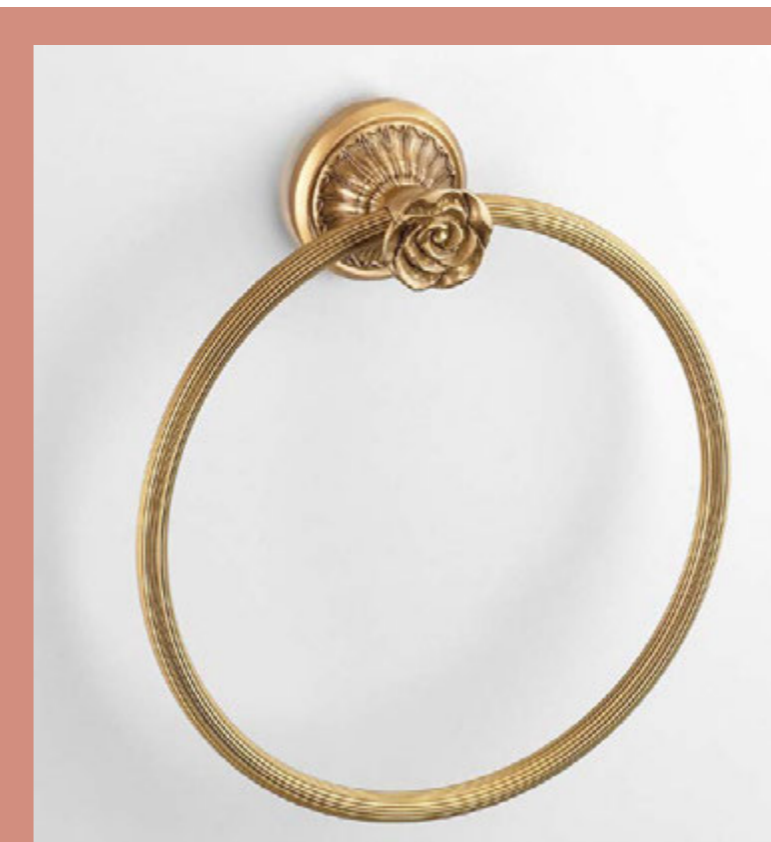

Art. BA148
ø 21 cm Sp 7 cm



Art. 1576
H 35 cm L 14 cm Pø 16 cm
1 x E14 x 40W



Set Giada

Fusione di ottone con finitura Nikel lucido / Polished chrome casting brass



Art. BA199
H 19 cm L 55 cm Sp 19 cm



Art. BA198
H 17 cm L 55 cm Sp 21 cm



Art. 1439
H 38 cm L 34 cm Pø 14 cm
2 x E14 x 40W



Art. BA267
H 24 cm L max 44 cm L min 20 cm
Mirror ø 18 cm



Art. BA197
H 19 cm L 22 cm Sp 19 cm



Art. BA299
H 40 cm L 22 cm ø 18 cm



Art. BA194
H 27 cm L 21 cm Sp 19 cm



Art. BA195
H 21 cm L 10 cm Sp 19 cm

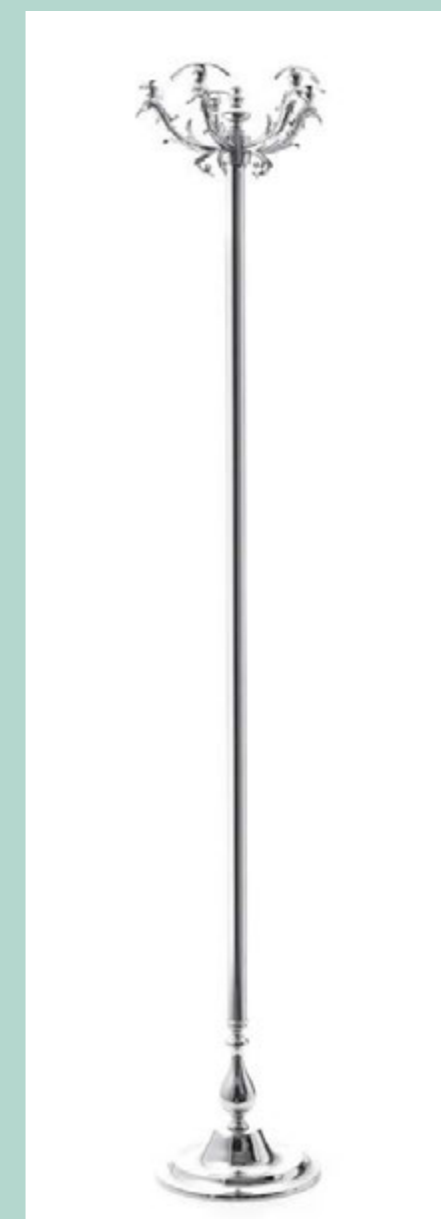

Art. 1624
H 180 cm ø 35 cm



Art. BA196
H 108 cm ø 38 cm

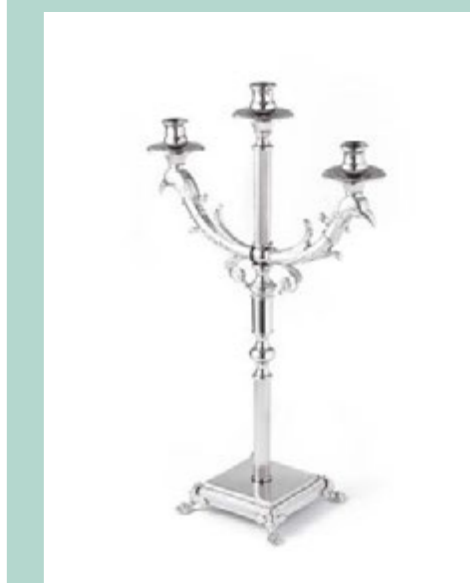

Art. 1623
H 52 cm L 32 cm

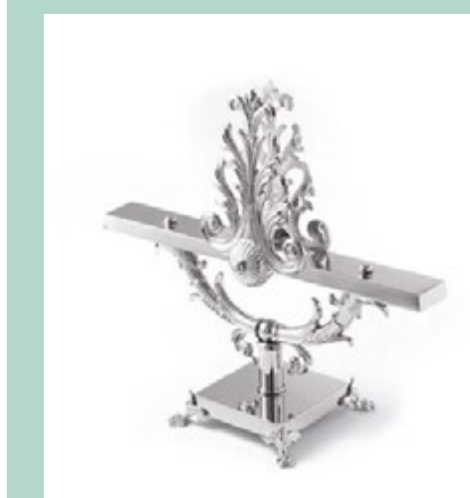

Art. 1625
H 37 cm L 41 cm - Magazine rack

Set Easy

Ottone con finitura cromo e vetro acidato / Brass in chrome colour and satin glass



Art. BA304
H 6 cm L 52 cm Sp 8 cm



Art. BA303
H 6 cm L 60 cm Sp 12 cm



Art. BA309
H 6 cm L 9 cm Sp 8 cm



Art. BA308
H 6 cm L 18 cm Sp 8 cm



Art. BA310
H 6 cm L 11,5 cm Sp 13 cm

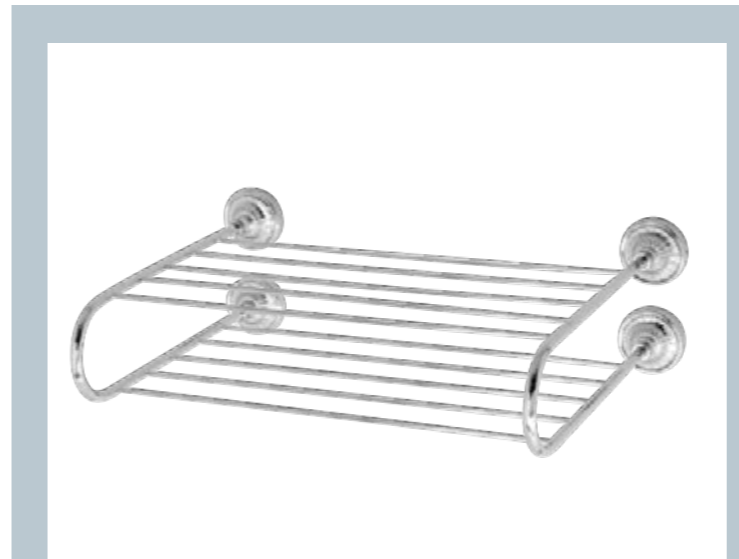

Art. BA306
H 14 cm L 45 cm Sp 32 cm



Art. BA311
H 24 cm L 24x13 cm



Art. BA307
H 32 cm L 15 cm Sp 12 cm



Art. BA302
H 18 cm L 14 cm Sp 12 cm



Art. BA301
H 9 cm L 12 cm Sp 12 cm



Art. BA319/wall
H 28 cm L max 43 cm
L min 20 cm





Set Cameo

Set in cristallo fiorentino molato a mano e base con elementi in fusione di ottone cromato

Bathroom set in hand-cut Florentine crystal with elements in fusion of chrome brass on the base

Art. BA212
H 26 cm ø 20 cm

Art. BA215
H 15 cm L 16x16 cm

Art. BA214
H 10 cm L 20x15 cm

Art. BA213
H 4 cm L 35x16 cm

Set Cameo

Set in cristallo fiorentino molato a mano e base con elementi in fusione di ottone cromato

Bathroom set in hand-cutted Florentine crystal with elements in fusion of chrome brass on the base

Art. BA693
H 7 cm ø 12 cm



Art. BA673
H 12 cm ø 8 cm



Art. BA674
H 12 cm ø 8 cm



Art. BA217
H 15 cm ø 8 cm

Art. BA216
H 20 cm ø 8 cm





Art. BA218
H 15 cm ø 8 cm



Art. 1848
H 94 cm Pø 50 cm
1 x E27 x 60W
Nappa N15

Set Cameo



Art. BA220/wall
H 21 cm ø 10 cm
Sp 13 cm



Art. BA221/wall
H 15 cm ø 10 cm
Sp 13 cm



Lavabo in cristallo incisione cameo donna/uomo.
Lavandino in cristallo italiano molato a mano
Bathroom sink made in Italian hand-cutted crystal

Art. BA680
Washbasin
H 25 cm ø 40 cm



Art. BA681 Watertap
H 35 cm L 27,3 cm



Art. BA682
Open drain + Metal ring
H 2,1 cm ø 6,2 cm

Art. BA679
Washbasin
H 25 cm ø 40 cm



Set Opale

Set in cristallo fiorentino
molato a mano

Set in hand-cutted
Florentine crystal

Art. BA240
H 26 cm ø 20 cm

Art. BA238
H 12 cm ø 8 cm

Art. BA237
H 18 cm ø 8 cm

Art. BA241
H 8 cm L 20 x 15 cm

Art. BA239
H 2 cm L 36x15 cm



Set Opale



Art. BA244/wall
H 15 cm ø 10 cm
Sp 13 cm



Art. BA243/wall
H 21 cm ø 10 cm
Sp 13 cm



Art. 1771/P
H 20 cm ø 41 cm
2 x E14 x 40W

Art. 1771/G
H 20 cm ø 50 cm
3 x E14 x 40W

Art. 1772/G
H 20 cm ø 50 cm
3 x E14 x 40W



Art. 1771/A1
H 24 cm Sp 14 cm
1 x G9 x 40W



Art. 1494/A
H 20 cm ø 50 cm
3 x E14 x 40W

Art. 1494/B
H 20 cm ø 50 cm
3 x E14 x 40W

Set Bolle

Art. BA408
H 26 cm ø 20 cm



Art. BA416/P
H 13 cm ø 18 cm



Art. BA415
H 15 cm L 13x13 cm



Art. BA412
H 23 cm Sp 12 cm



Art. BA411
H 14 cm Sp 12 cm



Art. BA414
H 6,5 cm ø 9 cm



Art. BA414
H 6,5 cm ø 9 cm



Art. BA410
H 2 cm L 36x15 cm



Art. BA416/G
H 16 cm ø 22 cm



Art. BA409
H 3 cm L 13 cm



Set Cavalli

Set in cristallo fiorentino molato
a mano con incisione cavallo

Set in hand-cutted Florentine
crystal with engraved horse

Art. BA325
H 15 cm L 15x15 cm



Art. BA334
H 26 cm ø 20 cm



Art. BA323
H 18 cm ø 8 cm



Art. BA324
H 12 cm ø 8 cm

Art. BA327
H 8 cm L 20x14 cm



Art. BA322
H 2 cm L 36x15 cm



Art. BA332
H 3 cm L 13 cm



Set Lapislazzulo

Cristallo italiano / Italian crystal

Il Paratume Marina

172



Art. BA186
H 26 cm ø 20 cm



Art. BA185
H 13 cm L 11x11 cm



Art. BA182
H 3 cm L 11x11 cm



Art. BA183
H 18 cm L 8x8 cm



Art. BA187
H 2 cm L 34x15 cm



Art. BA184
H 13 cm L 8x8 cm



Art. BA246/wall
H 13 cm Sp 9 cm

Art. BA245/wall
H 18 cm Sp 9 cm

Set Andalusite

Cristallo italiano / Italian crystal



Art. BA175
H 26 cm ø 20 cm



Art. BA181
H 15 cm L 15x15 cm



Art. BA178
H 18 cm L 8x8 cm



Art. BA180
H 11 cm L 11x11 cm



Art. BA176
H 2 cm L 34x15 cm



Art. BA179
H 13 cm L 8x8 cm



Art. BA177
H 3 cm L 11x11 cm

Set Andalusite



Art. BA288/wall
H 18 cm Sp 9 cm

Art. BA289/wall
H 13 cm Sp 9 cm



Set Zircono

Cristallo italiano / Italian crystal

Art. BA188
H 26 cm ø 20 cm



Art. BA193
H 15 cm L 15x15 cm



Art. BA190
H 18 cm ø 8 cm



Art. BA191
H 12 cm ø 8 cm



Art. BA187
H 2 cm L 34x15 cm



Art. BA192
H 8 cm L 20x13 cm



Set Quarzo

Cristallo italiano / Italian crystal

Art. BA173
H 18 cm ø 8 cm



Art. BA168
H 26 cm ø 20 cm



Art. BA171
H 8 cm L 20x14 cm

Art. BA172
H 12 cm ø 8 cm



Art. BA174
H 13 cm ø 8 cm



Art. BA169
H 3 cm L 18x10 cm



Art. BA170
H 2 cm L 36x15 cm

Set Agata

Cristallo italiano / Italian crystal



Art. BA161
H 18 cm ø 8 cm

Art. BA160
H 12 cm ø 8 cm

Art. BA157
H 26 cm ø 20 cm

Art. BA158
H 3 cm L 13 cm

Art. BA159
H 2 cm L 36x15 cm

Set Ossidiana

Cristallo italiano / Italian crystal

Art. BA152
H 26 cm ø 20 cm



Art. BA156
H 18 cm ø 8 cm



Art. BA153
H 3 cm L 13 cm

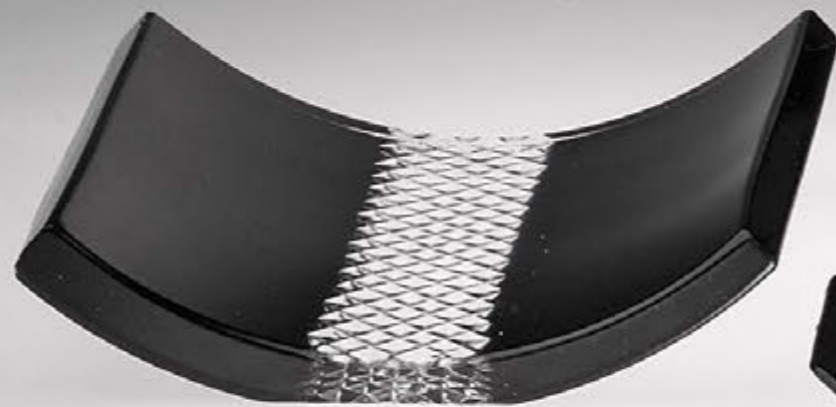

Art. BA154
H 2 cm L 34x15 cm



Art. BA155
H 12 cm ø 8 cm



Set Turchese

Cristallo italiano / Italian crystal

Art. BA165
H 12 cm ø 8 cm



Art. BA167
H 8 cm L 20x14 cm



Art. BA166
H 18 cm ø 8 cm



Art. BA162
H 26 cm ø 20 cm



Art. BA163
H 3 cm L 13 cm



Art. BA164
H 2 cm L 36x15 cm



Set Turchese

Il Paratume Marina

190



Art. BA261/wall
H 21 cm L 23 cm
Sp 12 cm



Art. BA262/wall
H 21 cm ø 10 cm
Sp 13 cm

Art. BA263/wall
H 15 cm ø 10 cm
Sp 13 cm



Art.ST41
Sp 16 cm

Art. ST35
Curtain rod with Swarovski elements
Sp max 17,5 cm
Final part: 16 cm



Art.ST42
Sp 16 cm

Art. ST34
Solid brass curtain rod
Sp max 17,5 cm
Final part: 16 cm

Curtain Rod



Art. ST40
H 20 cm
Sp 18 cm

Art. ST37
H 20 cm
Sp max 18 cm
Final part 1: 12 cm
Final part 2: 5 cm

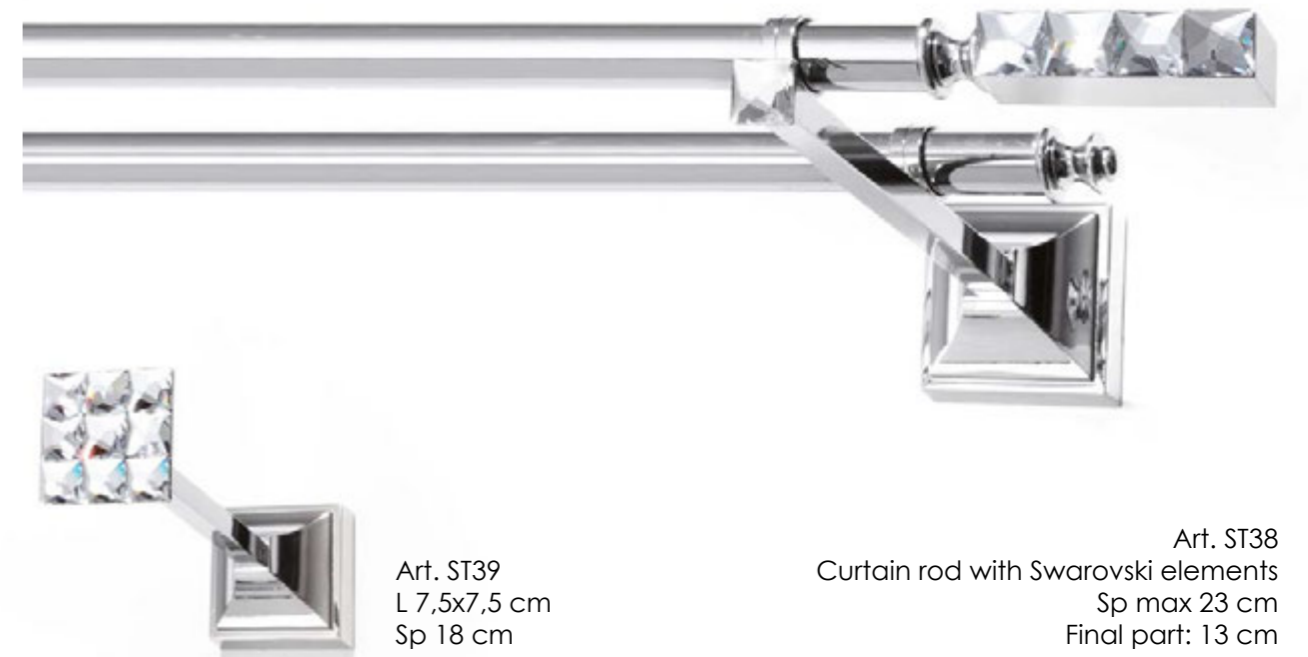

Art. ST39
L 7,5x7,5 cm
Sp 18 cm

Art. ST38
Curtain rod with Swarovski elements
Sp max 23 cm
Final part: 13 cm



Art. ST27/OVAM



Art. ST32



Art. ST5/2



Art. ST9/2



Art. ST28



Art. ST13/2



Art. ST14/2



Art. ST25



Art. ST30



Art. ST12/2



Art. ST26



Art. ST24



Art. ST31



Art. ST11/2



Art. ST10
Sporgenza max 17 cm. Bastone tenda con finale in vetro di Murano soffiato. Disponibile bastone singolo o bastone doppio. Colore sfera Murano: ambra - bianco/oro - blu - trasparente/oro.



Art. ST16
Sporgenza max 12,5 cm. Bastone tenda con finale in vetro di Murano a forma di "cubo" colore trasparente. Finitura ottone: argento vecchio - oro vecchio.



Art. ST29



Art. ST4/1



Art. ST5/2

Art. ST14/2

Art. ST9/2

Ambrass



Art. ST23
sporgenza max 14 cm



Art. ST2
sporgenza max 14 cm



Art. ST22
sporgenza 7 cm



Art. ST3
sporgenza max 16 cm



Diametro 15 cm



Art. ST1

ANELLO



ø interno 2,5 cm

FRUSTA



Art. ST21 lunghezza 1,30 m

Index

11	1	2	3	4	5	6	7	8	9
10	11	12	13	14	15	16	17	18	19
20	21	22	23	24	25	26	27	28	29
30	31	32	33	34	35	36	37	38	39
40	41	42	43	44	45	46	47	48	49
50	51	52	53	54	55	56	57	58	59



60 61

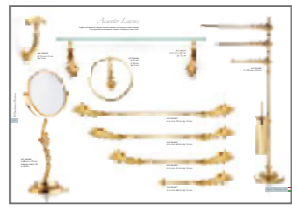

62 63



64 65



66 67



68 69

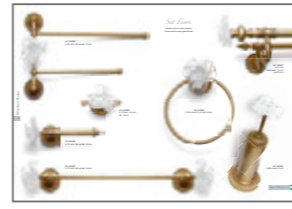

130 131



132 133



134 135



136 137



138 139



70 71



72 73

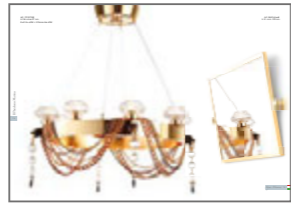

74 75



76 77



78 79

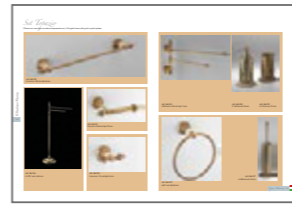

140 141



142 143



144 145



146 147

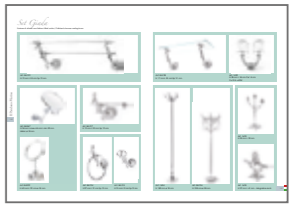

148 149

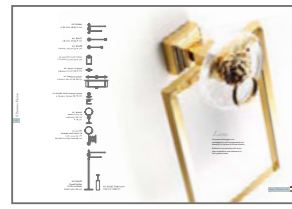

80 81



82 83



84 85



86 87



88 89

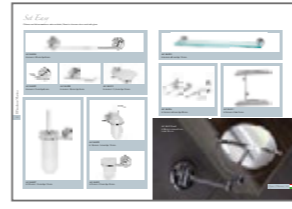

150 151



152 153



154 155



156 157



158 159



90 91



92 93

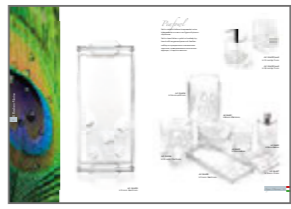

94 95



96 97



98 99



160 161

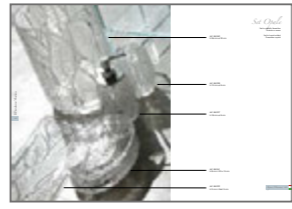

162 163



164 165



166 167

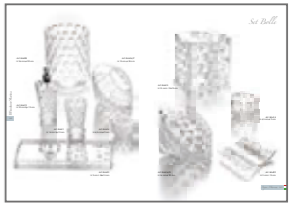

168 169

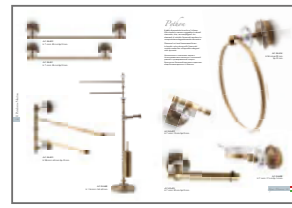

100 101



102 103



104 105



106 107

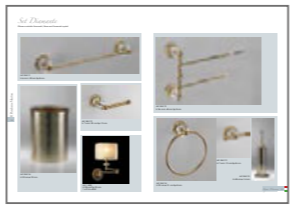

108 109



170 171

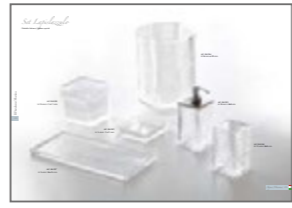

172 173



174 175

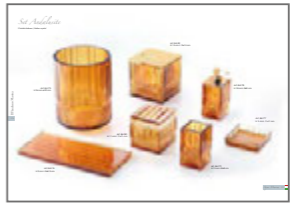

176 177



178 179

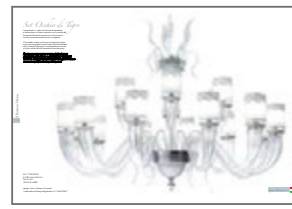

110 111



112 113



114 115



116 117



118 119



180 181



182 183



184 185



186 187



188 189



120 121

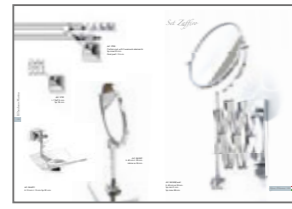

122 123

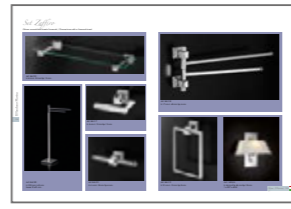

124 125

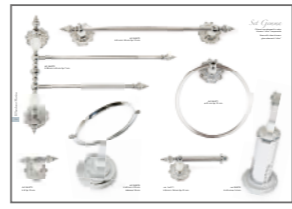

126 127



128 129



190 191

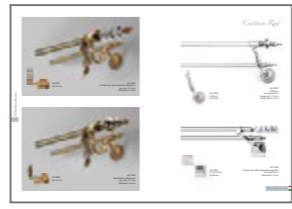

192 193



194 195



196

Bath Design

Il Cristallo italiano interamente molato a mano danza con elementi in fusione di ottone cromato in una combinazione emozionante di design classico

Italian Crystal entirely made and engraved by hand blends perfectly with chrome brass giving rise to the exciting combination of classic design

Итальянский хрусталь, изготовленный и вырезанный полностью вручную в интересном сочетании с хромированной латунью, придаёт коллекции нотки классического стиля

Il Paralume Marina s.r.l.
Vicolo Col Beretta, 6
36022 San Zeno di Cassola (VI) ITALY
Tel +39 0424 33 042
Fax +39 0424 511 817

www.ilparalumemarina.it
info@ilparalumemarina.it
Skype: ilparalumemarina

Design: Arch. Federica Vicentini
Proget Director: Thomas Simoncello
Printing: Girardi Print Factory

Tutti i diritti riservati.
Sono vietate la pubblicazione la trasmissione la fotocopiatura
e qualsiasi altra forma di duplicazione o riproduzione, parziali
e totali dei testi e della grafica qui contenuti, senza il preventivo
consenso scritto della ditta il Paralume Marina.
Il produttore si riserva il diritto di introdurre modifiche tecnologiche.
Il produttore declina qualsiasi responsabilità per eventuali errori di stampa.

Tutte le misure sono indicate in cm
H = Height, L = Width, \varnothing = Diameter,
P \varnothing = Shade diameter, Sp = Projection from the wall

MADE IN ITALY design: Arch. Federica Vicentini

Il Paralume Marina

Made in Italy
since 1987

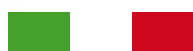

www.ilparalumemarina.it