

Made in Italy
since 1957

Contemporary Vol. 01

Il Paralume Marina



Marina Luce

Contemporary Vol. 01

Il Paralume Marina

Made in Italy
Since 1957



Il Paralume Marina

Contemporary Lighting

About us

La storia dell'azienda IL PARALUME MARINA nasce nel 1987 quando i coniugi Ferronato-Simoncello hanno fondato la loro piccola azienda familiare basata sulla comune passione per l'illuminazione decorativa. Negli anni seguire i figli Thomas e Simone hanno dato ulteriore impulso rispettivamente all'internazionalizzazione commerciale del prodotto in tutto il mondo ed ad un alto livello tecnico-progettuale degli stessi corpi illuminanti. Negli anni a seguire il loro lavoro ha elevato il marchio PARALUME MARINA ad un firma internazionale e questo brand è diventato sinonimo di dedizione e creatività combinate ad un eccellente grado di qualità artigianale esclusivamente Made in Italy. La produzione è basata su antiche tecniche di fusione dell'ottone, dal cristallo italiano, dalla soffiatura del vetro di Murano e dallo stile unico dei paralumi cuciti a mano dall'atelier della signora Marina. Il cristallo autentico Swarovski completa la scintillante brillantezza di questi pezzi unici. Ogni creazione è fatta a mano secondo le esigenze del cliente. Il Paralume Marina è specializzato nella produzione di pezzi su misura secondo i desideri del cliente e offre un ampio raggio di tessuti, passamanerie, finiture di ottone e di colori di vetro e cristallo da cui attingere. Questo dà l'opportunità al cliente di scegliere qualcosa di unico ed irripetibile creato esclusivamente da lui e per lui. Gli architetti e i designers de IL PARALUME MARINA sono disponibili a creare la giusta collezione per ogni interior a cominciare dai lampadari, a proseguire con spot ad incasso, bastoni tenda e accessori da bagno. Siamo orgogliosi di poter soddisfare qualsiasi richiesta sia per gli interni di case private sia per prestigiosi hotel. Potete ammirare i nostri progetti di illuminazione in tutto il mondo.

The story of the company IL PARALUME MARINA has started in 1987 when the spouses Ferronato-Simoncello have founded their small family-run business based on the common passion for decorative ITALIAN lighting. In the following years their sons Thomas and Simone have given further drive, respectively in internationally marketing the products all over the world and at high technical design levels of lights themselves. In 30 successful years their hard work have brought "Il Paralume Marina" an international fame and this brand has become a representation of commitment and creativity combined with high Made in Italy craftsmanship quality. It's production is based on the antique techniques of brass fusion, blowing of the Murano glass and Italian Crystal and unique recognizable style of the handsewn lampshades from Mrs. Marina. The authentic Swarovski crystals complement the sparkling beauty of the manufactures. Every item is created by hand and with consideration of every client's wish. Il Paralume Marina is specialized in producing of customized articles and always offers the wide range of various fabrics, trimmings, tassels, brass, crystal and glass colours to choose from. This way we give the Client opportunity to create every time something special and unrepeatable, something that He can call His own, made exclusively for Him. The architects and designers of Il Paralume Marina are ready to create the whole collection for any ambience starting with chandeliers and finishing with spotlights, bathroom accessories and curtain rods. We are able to satisfy any request, whether it is a private house or a luxury hotel. In fact on the list of projects completed there are numerous top-rate hotels and residences, villas and castles throughout the world.

История компании IL PARALUME MARINA началась в 1987 году, когда супруги Ферронато-Симончелло основали свой маленький семейный бизнес, движимые общей любовью к декоративному освещению. Годы спустя их традицию не только продолжили, но и развили сыновья Томас и Симоне, каждый из которых внес свой вклад в развитие компании как в международном маркетинге, так и в высокотехнологичном дизайне светильников. 30 лет тяжелой, но успешной работы принесли IL PARALUME MARINA международную славу и сегодня этот бренд ассоциируется с креативностью и самоотдачей, обрученной с высочайшим качеством продукта, сделанного в Италии. Производство основано на старинных технологиях литья латуни, выдувания муранского стекла и флорентийского хрусталя и, конечно же, на уникальном и узнаваемом стиле шитых вручную абажуров от г-жи Марины. Сияющую красоту изделий дополняют подлинные кристаллы Swarovski. Каждое изделие создано строго вручную, с учетом всех пожеланий заказчика.

IL PARALUME MARINA специализируется на производстве персонализированных изделий и всегда предлагает широкий спектр тканей, кантов, кистей, большой выбор отделок металла, хрусталя и муранского стекла. Это позволяет Заказчику каждый раз создавать что-нибудь особенное и неповторимое, что он может назвать Своим, сделанным специально для Него. Архитекторы и дизайнеры

IL PARALUME MARINA готовы создать полную коллекцию для любого помещения, начиная от люстр и заканчивая встроенными светильниками, аксессуарами для ванных комнат, а также карнизами. Мы способны удовлетворить любой запрос, будь-то частный дом или роскошный отель, о чем свидетельствуют снимки завершенных проектов, среди которых топ-рейтинговые гостиницы и резиденции, виллы и замки по всему миру.

Made in Italy
Since 1987



design
Arch. Ferdinando Vicini

Art. 2049/CH18/LU
ø 110 cm H 150 cm
18 x G9 x LED 10W



Art. 2049/T/LU
ø 20 cm H 69 cm
3 x G9 x LED 10W



Art. 2049/A2/LU
L 18 cm H 60 cm Sp 12 cm
2 x G9 x LED 10W





*Sinuous and elegant honey
Murano glass horns imbue
luxury and lightness to this
collection of chandeliers.
Sophisticated design creates
timeless exclusive interiors.*



Art. 2049/CH6/LU
ø 60 cm H 80 cm
6 x G9 x Led 10W

Art. 2049/FL/SG
ø 60 cm H 170cm
6 x G9 x Led 10W



Art. 2049/CH48/SG
ø 160 cm H 247 cm
48 x G9 x Led 10W





Art. 2049/T/CAFFE/LU
ø 20 cm H 69 cm
3 x G9 x 40W



Art. 2049/RETT10/CAFFE/LU
L 108 x 53 cm H 84 cm
10 x G9 x Led 10W



8

Art. 1932/CH24
ø 144 cm H 92 cm
24 x E14 x 40W

*Handmade, it's a surplus
the added value of marina luce will always be the quality of our products.
all the chandeliers come out the factory as unique pieces handmade one
by one by our incredibly talented seamstresses. they are led by the one
and only marina, the founder of the company and master of beauty, that
hands down all the secrets to the new generation.*

©
IlParalumeMarina





*The strength and the uniqueness
of murano's glass revive in this
contemporary interpretation of ca'
Rezzonico: the mirrored elements
give poetic elegance to any interior.*

Art 1932/CH24
ø 144 cm H 92 cm
24 x E14 x 40W





Art 1954/G
P ø 29 cm H 92 cm
1 x E27 x 60W

Art 1954/P
P ø 23 cm H 67 cm
1 x E27 x 40W



Art 1948/LU
P oval 46x25 cm H 98 cm
1 x E27 x 60W
Nappa N10 Oo



Art 1932/A1
L 10 cm H 52 cm
Sp 8 cm
1 x E14 x 40W

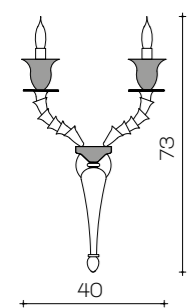

Art 1932/A2
L 40 cm H 73 cm Sp 24 cm
2 x E14 x 40W

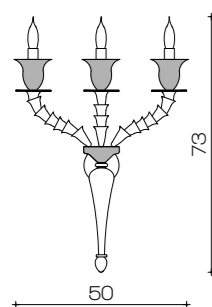

Art 1932/A3
L 50 cm H 73 cm Sp 24 cm
3 x E14 x 40W



Art. 1935/FL
Pø 58 cm H 187 cm
2 x E27 x 60W

Art 1935/CH8
ø 14 cm H 82 cm P ø 24 cm
8 x E14 x 40W





Art 1932/CH8
ø 96 cm H 82 cm
8 x E14 x 40W

Art. 1947/NL
Pø 38 cm H 98 cm
1 x E27 x 60W
Nappa N.10 Argento





Lampadario in vetro di Murano trasparente, dal design esclusivo degli elementi sapientemente forgiati da alta maestria artigianale vetraia, sintesi di linee geometriche scolpite che determinano una grande personalità. Ogni braccio viene coronato con un colletto di ottone cromato con inseriti uno ad uno Swarovski Elements. Paralumi in organza bianca lucida su pvc decorati con passamaneria barocca argentata. Pensato e costruito Full made in Italy.

Art 1770/CHB
ø 144 cm H 102 cm
P ø 12 cm
B x E14 x 25W

design
Arch. Ferdinando Vicentini
International Design
Registration N° DM/07987



20

Ninfea. Chandelier made of transparent Murano glass by exclusive design of the elements skillfully forged by high glassmaking craftsmanship, synthesis of geometric lines that determine a great personality. Every arm of the chandelier is crowned with collar of chromed brass and Swarovski Elements carefully inserted one by one. The lampshades are made of white glossy organza on PVC base and decorated with silver baroque trimming. Designed and made Full made in Italy

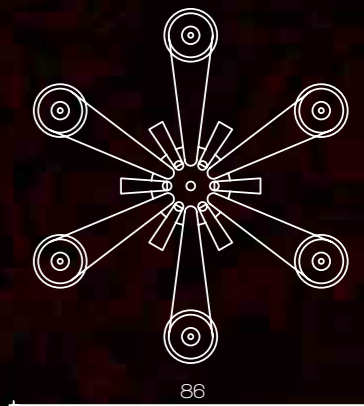

Art.1770/CH6
H 86 cm ø 86 cm
Pø 12 cm
6 x E14 x 25W

21

Il Paralume Marina

design:
Arch. Federica Vicentini
"International Design
Registration N°: DM/079817"



Art. 1770/P
 ø 12 cm H 28 cm
 1 x E14 x 25W

Люстра из прозрачного муранского стекла с эксклюзивным дизайном элементов, умело изготовленных первоклассными мастерами стекольного дела, является синтезом плавных геометрических линий. Каждый рожок коронован хромированным наконечником с инкрустацией вручную каждого отдельного кристалла Swarovski Elements. Абажуры выполнены из белой блестящей органзы на ПВХ и украшены серебряной обложкой барокко.



design:
 Arch. Federica Vicentini
 "International Design
 Registration N°: DM/079817"

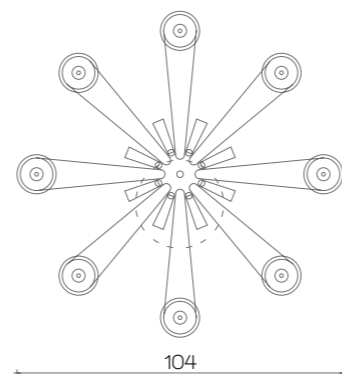

Art. 1770/CH8
 ø 104 cm H 90 cm
 Pø 12 cm
 8 x E14 x 25W



Art. 1770/G
 ø 50 cm H 94 cm
 1 x E27 x 60W



Art.1770/A1
ø 32 cm H 42 cm
Pø 12 cm
1 x E14 x 25W



Art. 1770/FL
ø 50 cm H 182 cm
1 x E27 x 60W



Art.1770/A5
ø 62 cm H 92 cm
Pø 12 cm
5 x E14 x 25W





Art. 1770/CH6/BI/ORO24K
ø 83 cm H 86 cm Pø 12 cm
6 x E14 x 25W





Art. 1849/P
P ovale 40 x 23 cm H 92 cm
1 x E27 x 60W

Art. 1849/G
P ovale 46 x 26 cm H 108 cm
1 x E27 x 60W



Art. 1770/CH6/ROSSO/LU
 ø 83 cm H 86 cm
 Pø 12 cm
 6 x E14 x 25W

Art.1770/CH6/FUME/LU
 ø 83 cm H 86 cm
 Pø 12 cm
 6 x E14 x 25W

Art. 1770/CH6/AMBRA/
 ø 83 cm H 86 cm
 Pø 12 cm
 6 x E14 x 25W

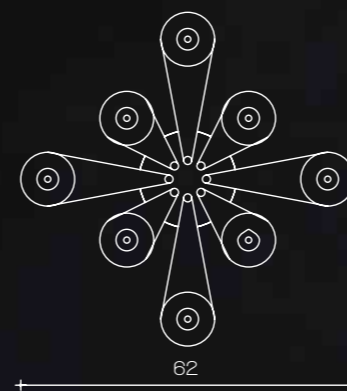

Art.1770/Flambeaux 8L
 ø 62 cm H 97 cm
 8 x E14 x 25W



design:
Arch. Federica Vicentini
"International Design
Registration N°: DM/079817"



Art 1970/CH8/NL
ø 113 cm H 80 cm
8 x E14 x 40W

Art 1969/CH8/NL
ø 107 cm H 80 cm
8 x E14 x 40W

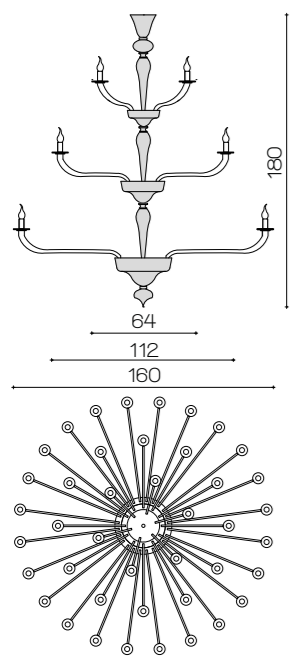

Art 2009/CH42
 ø 160 cm H 180 cm
 42 (24+12+6) x E14 x 40W

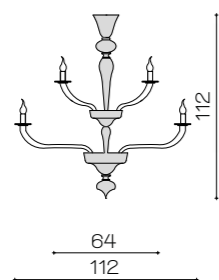

Art 2009/CH18
 ø 112 cm H 112 cm
 18 x E14 x 40W

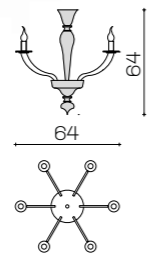

Art 2009/CH6
 ø 64 cm H 64 cm
 6 x E14 x 40W

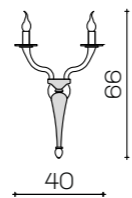

Art 2009/A2
 L 40 cm H 66 cm Sp 24 cm
 2 x E14 x 40W



Art. 2009/CH12
 ø 112 cm H 82 cm
 12 x E14 x 40W

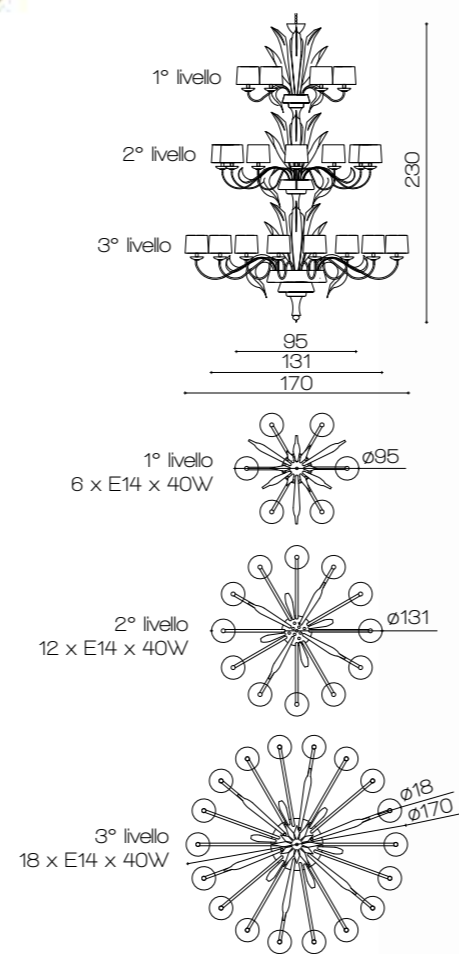
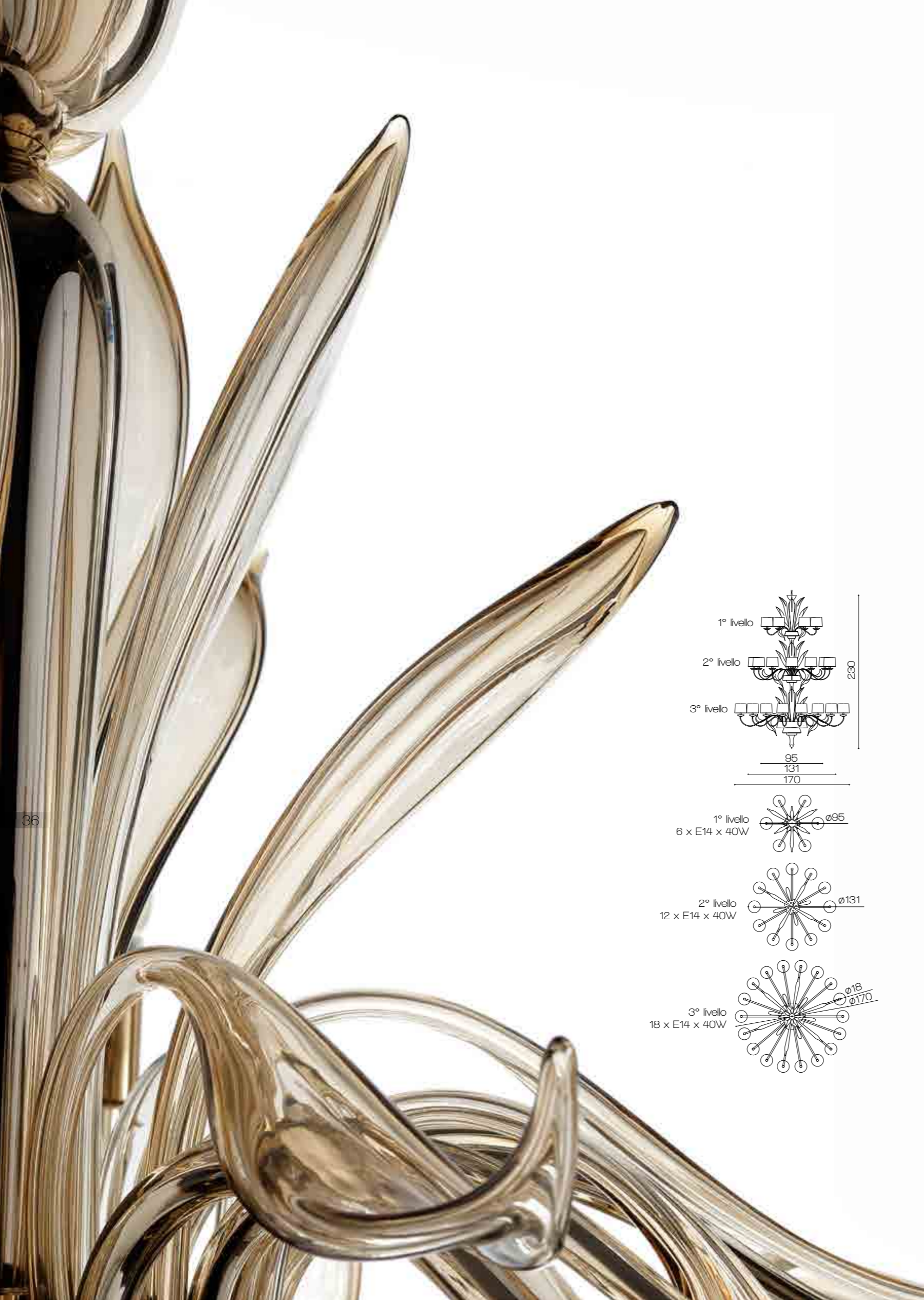

Art. 1930/CH36
 \varnothing 170 cm H 230 cm P \varnothing 18 cm
36 x E14 x 40W





Murano's glass flames animate this collection. Passion with handcrafted devotion and design are combined into this lifestyle eclectic and harmonic at the same time

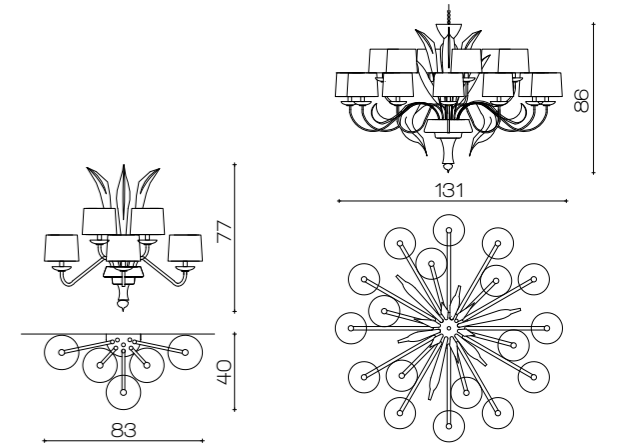

Art.1930/CH12
 ø 131 cm H 95 cm Pø 18 cm
 12 x E14 x 40W

Art. 1930/A5
 L 83 cm H 77 cm
 Pø 18 cm Sp 40 cm
 5 x E14 x 25W

Art. 1930/CH8
 ø 131 cm H 86 cm
 P ø 18 cm
 18 x E14 x 40W



Art. 1931/G/HONEY
Pø 37 cm H 97 cm
1 x E27 x 60W



Art 1931/CH12
ø 17 cm H 95 cm
12 x E14 x 40W



Art 1931VA2
L 40 cm H 64 cm
Sp 20 cm
2 x E14 x 40W



Art. 1931G/CAFFÉ
Pø 37 cm H 97 cm
1 x E27 x 60W



Art 1931/CH8
ø 89 cm H 77 cm
8 x E14 x 40W





Art. 1931/G/FUMÉ
Pø 37 cm H 97 cm
1 x E27 x 60W



Art 1931/G/RED
Pø 37 cm H 97 cm
1 x E27 x 60W





Art.2079/A5/LU
 L max 48 cm Sp 31 cm
 H 41 cm (without bulb)
 5 x E14 x Led5W



Art. 2079/CH30/LU
 ø 110 cm H 77 cm
 +50 cm steel cable
 30 x E14 x Led 5W
 + 3 X GU10 x LED 10 W



Art.2079/OVALCH16/LU
 L 150 x 82 cm H 77 cm
 +50 cm steel cable
 16 x E14 x 25W
 + 3 X GU10 x LED 10 W



Art. 2079/T/OV
 ø 26 cm H 72 cm Pø 12 cm
 3 x E14 x 25W



Art. 2079/CH18/NL/BI
Ø 128 cm Pø 18 cm H 77 cm
+50 cm steel cable
18x E14 x 25W
+ 3 X GU10 x LED 10 W



Art. 2089/NL
Pø 25 cm H 80 cm
1 x E27 x 60W



Art. 2087/NL
Pø 30 cm H 85 cm
1 x E27 x 60W





Art 1965/CH15
ø 110 cm H 80 cm
15 x G9 x 40W

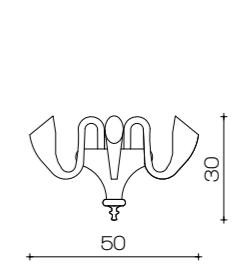

Art 1965/A3
ø 50 cm H 30 cm
3 x G9 x 40W

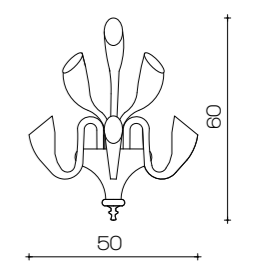

Art 1965/A6
ø 50 cm H 60 cm
6 x G9 x 40W







Art. 2037/CH16/KR
ø130 cm H80 cm
16 x E14 x 40W



Art. 2037/A2/KR
L 35 cm H 32 cm Sp 15 cm
2 x E14 x 40W



60

Art 1919/CH54
L 190x91 cm H 180 cm P ø 12 cm
54 x E14 x 25W + 7 GU 10 Le d 10W
with Asfour crystal



61



Il Paralume Marina

The eleven softener dri c ke l
re ctanges are danc ing in a
very exclusive and elegant
composition the sparkling
c andles are made with Italian
crystal and the paralume with
grey organza and pvc are
decorated with shiny chain
black crystals. A contemporary
and exclusive signature made
by Il Paralume Marina



Art 19B/CH54
L 190x91 cm H 100 cm P ø 12 cm
54 x E14 x 25W + 7 GU 10 Le d 10W



Art. 1918/CH32
L 160x65 cm H 75 cm Pø 12 cm
32 x E14 x 25W + 7 GU10 Led 10W



*Cerchi in finitura oro oppure
ottone cromato sostengono file di
perle di cristallo, collane lucenti
che definiscono ambienti ricercati,
eleganti, evocativi. Paralumi in
organza bianca lucida su pvc sono
decorati da passamaneria filo oro.*

The brass circles in chrome or in gold cover support the rows of crystal pearls, they are like sparkling necklaces that identify the elegant evocative ambiances. The lampshades in white shiny organza on pvc are decorated with gold thread trimming.

Кольца из латуни, под золото или хромированные, поддерживают ряды хрустальных бус. Эти сияющие ожерелья задают тон изысканности и элегантности. Абажуры из белой блестящей органзы на ПВХ обведены золотыми тесёмками.



Art.1703/CH40/KR/TR
ø 162 cm H 165 cm Pø 12 cm
40 x E14 x 25W + 3 GU10 Led 10W





Art. 1703/FL/LU/TR
ø 65 cm H 190 cm Pø 12 cm
8 x E14 x 40W



Art. 1703/CH24/LU/TR
ø 112 cm H 120 cm Pø 12 cm
24 x E14 x 40W + 3 GU10 Led 10W





Art.1703/CH8/LU/TR
 ø 65 cm H 82 cm Pø 12 cm
 8 x E14 x 25W

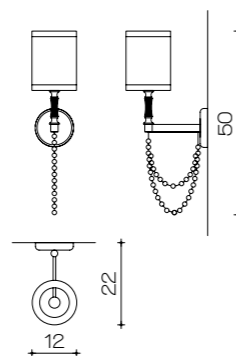

Art. 1703/A1/LU/TR
 L 12 cm H 50 cm
 Sp 22 cm
 Pø 12 cm
 1 x E14 x 25W

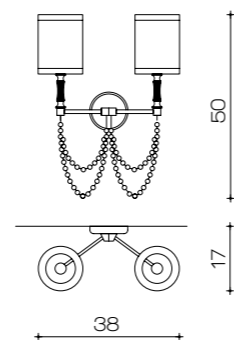

Art.1703/A2/LU/TR
 L 38 cm H 50 cm
 Sp 17 cm Pø 12 cm
 2 x E14 x 25W

Art.1703/A4/LU/TR
 ø 43 cm H 50 cm Pø 12 cm
 4 x E14 x 25W



Art.1703/G/LU/TR
 ø 42 cm H 82 cm Pø 12 cm
 4 x E14 x 25W





Art.1949/A2/LU
L 40 cm H 52 cm
Sp 21 cm Pø 14 cm
2 x E14 x 25W



Art.1949/FLAMBÒ/LU
ø 42 cm H 83 cm
Pø 14 cm
4 x E14 x 25W



Art.1949/FL/LU
ø 64 cm H 192 cm
Pø 14 cm
8 x E14 x 25W



Art.1949/CH16/LU
ø 111 cm H 111 cm
Pø 14 cm
16 x E14 x 25W





Art. 2115/FL/SG
L 46 cm H 192 cm
2 x E14 x 25W



Art. 2115/CH16/SG
L 205 cm x 50 cm x H 80 cm
16 x E14 x 25W



Art. 2115/A1/SG
L 18 cm Sp 25 cm H 90 cm
1 x E14 x 25W



Art. 2056/CH12/OV
L 152 cm x 90 cm H 90 cm
Metal base: 100 x 22 cm
+ 50 cm stell cable
12 X G9 X 5W led



Art. 2056/CH12/OV
L 152 cm x 90 cm H 90 cm
Metal base: 100 x 22 cm + 50 cm stell cable
12 X G9 X 5W led





Art.2056/A1
L 25 cm H 58 cm Sp 16 cm
1 X G9 x 5W led



Art. 2056/T/OV
L 31 x 12 cm H 63 cm
2 X G9 x 5W Led





Art. 2088/NL
Pø 25 cm H 80 cm
1 x E27 x 60W

Art. 1999
H 100cm ø 100cm
12X G9 X 40W



Art. BA624/P
L 36X 38cm H 62cm



Art. BA624/G
L 61 X 38cm H 62cm



Art 2003/CH2
ø 17 cm H 72 cm
2 x E27 x 60W



Art 2004/CH2
ø 17 cm H 72 cm
2 x E27 x 60W



Art 2039/CH18/KR
ø 170 cm H 65 cm
+ 50 cm c hain
18 x E14 x 40W





Art.1917
H 76cm L 40cm
2x E27x60W

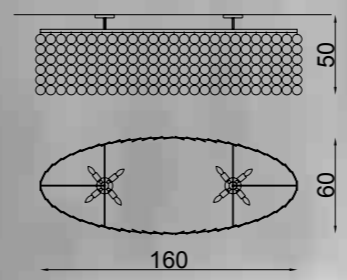

Art. 2085/OVAL
L 160 x 60 cm H 50 cm
8 x E27 x 60W



Art. 1946/CH8/NL
 ø 93 cm H 68 cm
 8 x E14 x 40W

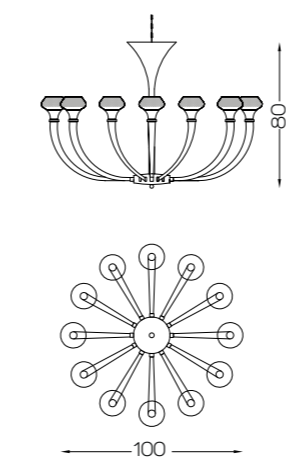

Art. 1946/CH12/NL
 ø 100 cm H 80 cm
 12 x E14 x 40W

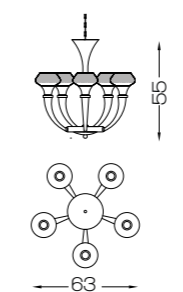

Art. 1946/CH5/NL
 ø 63 cm H 55 cm
 5 x E14 x 40W

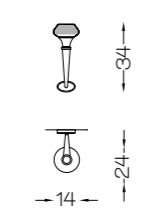

Art. 1946/A1/NL
 L 14 cm H 34 cm Sp 24 cm
 1 x E14 x 40W



Art.1946/CH8/LU
 ø 93 cm H 68 cm
 8 x E14 x 40W



Art. 1946/A2/NL
L 40 cm H 32 cm Sp 20 cm
2 x E14 x 40W

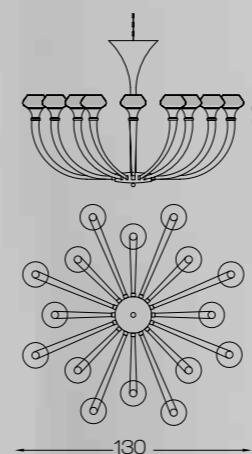

Art.1946/CH16/LU
ø 130 cm H 80 cm
16 x E14 x 40W



Art. 2072/CH12/BI
 ø 66 cm H 128 cm
 +50 cm steel cable
 12 x G9 x Led 10W



Art.2071/CH15/BI
 ø 81 cm H 92 cm
 +50 cm steel cable
 15 xG9 x Led 10W

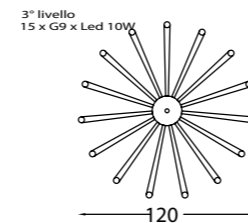
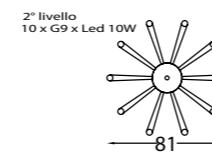
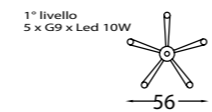
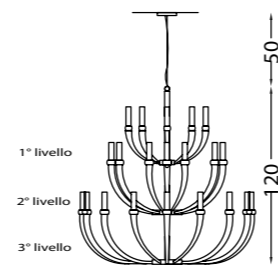

Art. 2071/CH30/BI
 ø120 cm H 120 cm
 +50 cm steel cable
 30 xG9 x Led 10W

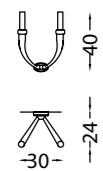

Art. 2071/A2/BI
 L 30 cm H 40 cm
 Sp 24cm
 2 xG9 x Led 10W

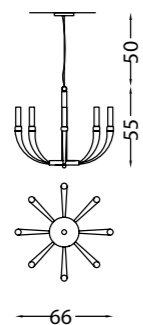

Art.2071/CH8/BI
 ø 66 cm H 55 cm
 +50 cm steel cable
 8 xG9 x Led 10W

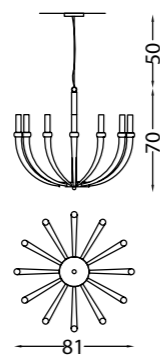

Art. 2071/CH12/BI
 ø 81 cm H 70 cm
 +50 cm steel cable
 12 xG9 x Led 10W

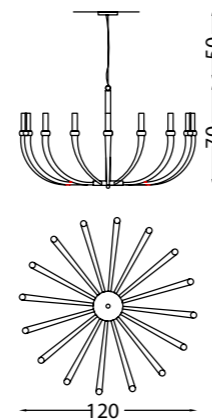

Art. 2071/CH16/BI
 ø 120 cm H 70 cm
 +50 cm steel cable
 16 xG9 x Led 10W





Art.1834/FL
Pø 50 cm
H 189 cm
2 x E27 x 60W



Art.1834/G
Pø 20 cm H 63 cm
1 x E27 x 60W

Art.1834/P
Pø 18 cm H 47 cm
1 x E14 x 40W



METAL COLOR: NIKEL NERO

Art.1834/CH8
ø 93 cm H 76 cm Pø 20 cm
8 x E14 x 40W



Art.1834/A2
Pø 40 cm
H 50 cm
2 x E14 x 40W



Art 1946/NL/AZ
P ø 34 cm H 104 cm
1 x E27 x 60W
1 x G9 x 25W

Design Arch. Federico Vicentini



Art 1946/NL/AM
P ø 34 cm H 104 cm
1 x E27 x 60W
1 x G9 x 25W

Art 1946/NL/AZ
P ø 34 cm H 104 cm
1 x E27 x 60W
1 x G9 x 25W

Art 1946/NL/TR
P ø 34 cm H 104 cm
1 x E27 x 60W
1 x G9 x 25W

Art 1946/NL/VE
P ø 34 cm H 104 cm
1 x E27 x 60W
1 x G9 x 25W

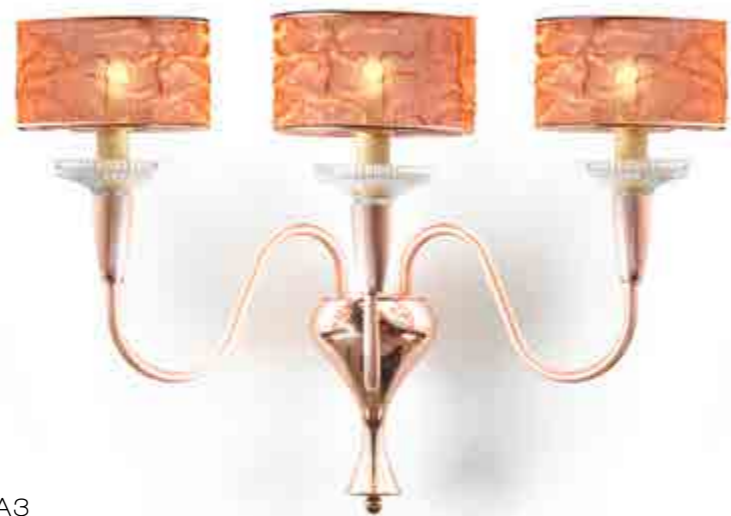

Art1912/A3
L 67 cm P ø 18 cm
H 50 cm Sp 44 cm
3 x E14 x 40W



Art1912/P
P ø 25 cm H 46 cm
1 x E27 x 60W

Art1912/G
P ø 40 cm H 82 cm
1 x E27 x 60W



Set of lighting objects by exclusive design obtained from dimpled tube, lampshades in fabric with copper on transparent pvc base and shiny metal parts make this combination well-balanced



Art1912/CH12
ø 140 cm H 102 cm
P ø 18 cm
12 x E14 x 40W



Art 1912/CH8/ORO24K
ø 11 cm H 75 cm
P ø 18 cm
8 x E14 x 40W



Art 1912/CH5/NL
ø 74 cm H 54 cm
P ø 18 cm
5 x E14 x 40W





CHROME METAL COLOR

Art. 2038/A2/KR
L 43 cm H 22 cm Sp 22 cm
2 x E14 x 40W



Art. 2038/CH8/KR
ø 95 cm H 75 cm
8 x E14 x 40W
+ 3 x E14 x 5W
LED ONLY



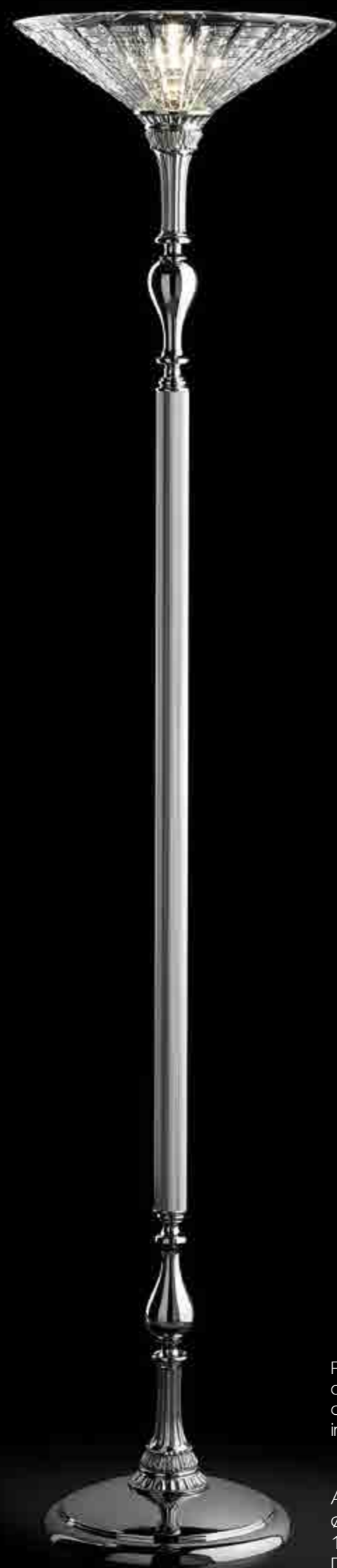

Plafoniera in fusione di ottone cromo con cristallo fiorentino inciso a mano.

Art.1441/FL Cromo
 ø 39 cm H 184 cm
 1 x E27 x 60W
 Dimmer included



Art.1494/A
 ø 50 cm H 20 cm
 3 x E14 x 60W

Art.1494/B
 ø 50 cm H 20 cm
 3 x E14 x 60W

Art.1621/B Applique
 ø 39 cm H 17 cm
 1 x G9 x 40W

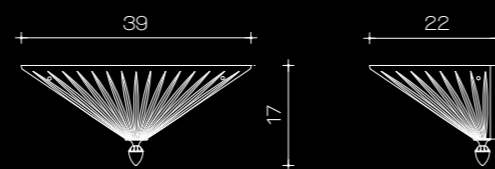

Lampada in cristallo fiorentino inciso a mano.

◀ Paralume nero con bordo nero argento.

Paralume arricciato in seta pura e righine argento. ▶

Art.1410/P/KRTR
 Pø 23 cm H 57 cm
 1 x E27 x 60W

Art.1410/G/KRTR
 Pø 40 cm H 70 cm
 1 x E27 x 60W
 Nappa N. 26



Art. 1892
Pø 45 cm H 126cm
1 x E27 x 60W



Art. 1913/CH8/NN
ø 92 cm H 80 cm Pø 15 cm
8 x E14x 40W + 3 GU10 Led 10W





106

- Art 1913/P/VE
P ø 15 cm H 20 cm
1 x E14 x 40W
- Art 1913/P/AZ Z
P ø 15 cm H 20 cm
1 x E14 x 40W
- Art 1913/P/TR
P ø 15 cm H 20 cm
1 x E14 x 40W
- Art 1913/P/RS
P ø 15 cm H 20 cm
1 x E14 x 40W
- Art 1913/P/VI
P ø 15 cm H 20 cm
1 x E14 x 40W



107

Art 1913/A1/NL
P ø 15 cm H 20 cm
1 x E14 x 40 W





METAL COLOR: ORO24K

Art 1910/CH8/ORO24K
 ø 97 cm H 106 cm
 8 x E14 x 60W
 3 GU 10 Le d 10W

Art 1910/AVORO24K
 L 25 cm H 43 cm Sp 15 cm
 1 x E14 x 60W
 + Le d SMD bianco fre ddb
 Lumen 60 su fflex S trip 1,07 W



Colle ction of lighting obje cts with mi co
 c asting animals, ename le d brass and
 bob c c heinc le arital an hand- cut crystal





Art 191A/ORO24K
L 25 cm H 4,5 cm Sp 15 cm
Le dS MDbiancofre ddbLumen
60 su flex S trip 1,07 W

Art 191G/ORO24K
L 24 cm H 27 cm Sp 4,5 cm
Le dS MDbiancofre ddbLumen20
su flex S trip 2,14 W



Art 191P/ORO24K
L 20 cm H 21 cm Sp 4,5 cm
Le dS MDbiancofre ddbLumen70
su flex S trip 1,26 W



Art. 2086/LU
Pø 25 cm H 69 cm
1 x E27 x 60W



Art. 2086/NL
Pø 25 cm H 69 cm
1 x E27 x 60W

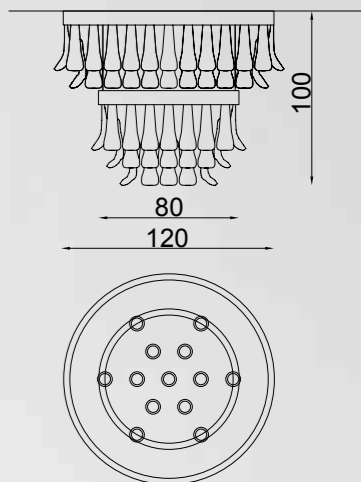

Art. 2015/NL
ø 120 cm H 100 cm
Lumen Colour light 2700 K°
Lumen 7000 +12 x GU10 LED 5W
(bulbs not included)

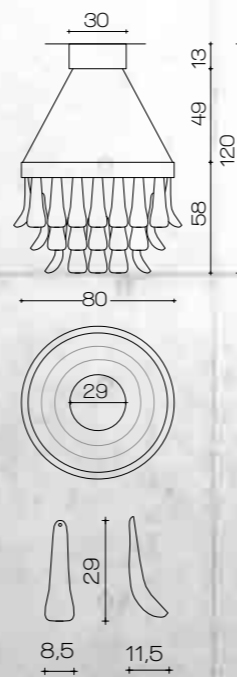

Art 1939 Chandelier
 ø 80 cm H 58 cm
 + Ceiling plate H 13 cm ø 30 cm
 with 3 GU 10 Led 10W
 H at 120 cm + Strip Led
 Colour light 2700 K° Lumen 8550

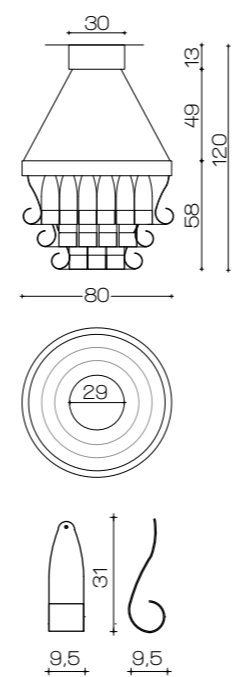

Art 1937 Chandelier
 ø 80 cm H 58 cm
 + Ceiling plate H 13 cm ø 30 cm with
 3 GU 10 Led 10W
 H at 120 cm + Strip Led
 Colour light 2700 K° Lumen 8550

Illuminating metal rings with
 polished gold, priceless and
 fantastic glass jewelry from the
 ancient Italian tradition revisited
 in a contemporary design.
 A fantasy and strictness mix



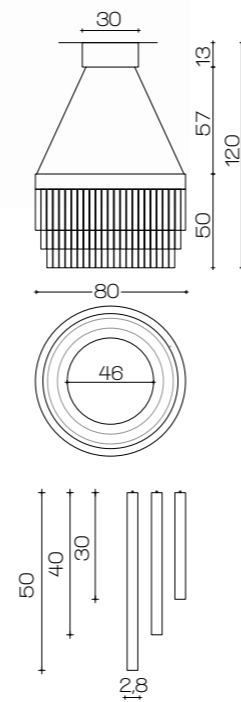

Art 1971
 ø 80 cm H 50 cm
 + Ceiling plate H 13 cm ø 30 cm with 3 GU 10 Led 10W
 H 120 cm Luce colore 2700 K° Lumen 8550

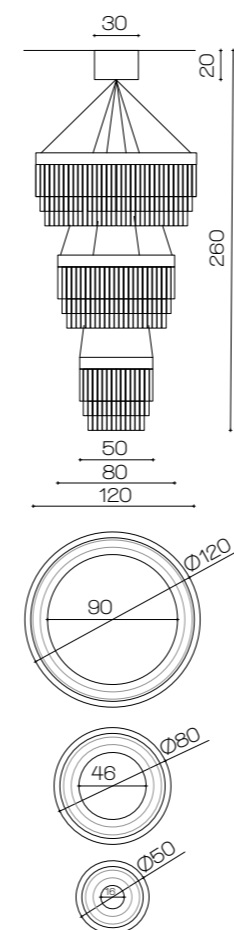

Art 1972
 ø 120 cm H 260 cm
 + Ceiling plate H 20 cm ø 30 cm with
 3 GU 10 Led 10W + Strip Led
 Colour light 2700K Lumen 16530

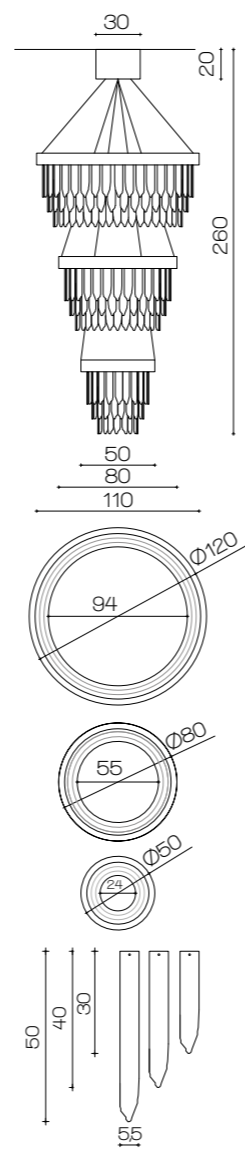

Art 1961/LU
 ø 120 cm H 260 cm
 + Ceiling plate H 20 cm ø 30 cm with 3
 3 GU 10 Led 10W + Strip Led
 Colour light 2700K Lumen 16530

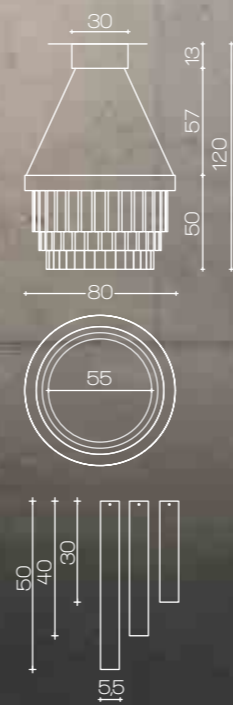

Art 1938/LU
 ø 80 cm H 52 cm
 + Ceiling plate H 13 cm ø 30 cm
 with 3 GU 10 Led 10W
 H ø 120 cm + Strip Led
 Colour light 2700 K° Lumen 8550





Art 1994
L 80 x 60 cm H 50 cm
12 x E14 x 40W



Art 1994/A
L 30 cm H 30 cm Sp 20 cm
2 x E14 x 40W





Art.1984/P
 ø 100 cm H 100 cm
 +Ceiling plate ø 30 cm H 8 cm
 Steel cable 140 cm
 9 x E27 x 60W + 3 GU 10 Led 10W

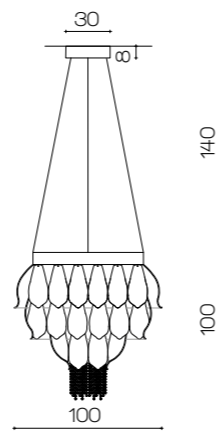

Art.1984/G Chandelier
 with Glass leaf perl color
 ø 136 cm H 105 cm
 +Ceiling plate ø 30 cm H 8 cm
 Steel cable 140 cm
 12 x E27 x 60W + 3 x GU10 Led 10W

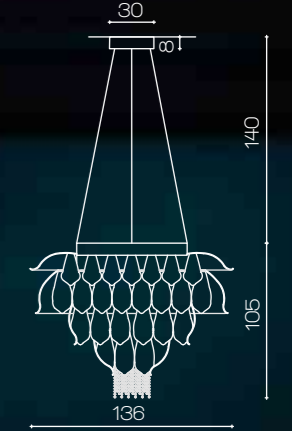



124

Art 1966/NL
 ø 90 cm H 130 cm
 (only c. hanger H 55 cm)
 12 x E14 x 40W
 +3 GU 10 x LED 4W



125

Il Paralume Marina

Art 1960
 ø 80 cm H 43 cm
 + Ceiling plate H 13 cm ø 30 cm
 with 3 GU 10 Led 10W
 H ø 120 cm
 Colour light 2700K° Lumen 8550

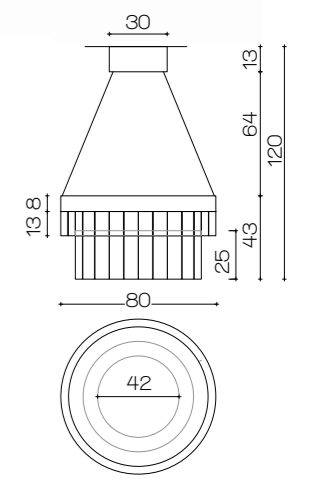



Art 1958 LED GLAS S
CILINDER FLOW ERS
ø 80 cm H 285 cm
57 LED 450W

Art 1958 GLAS S CILINDER
FLOW ERS
ø 80 cm H 285 cm
15 x E14 x 40W

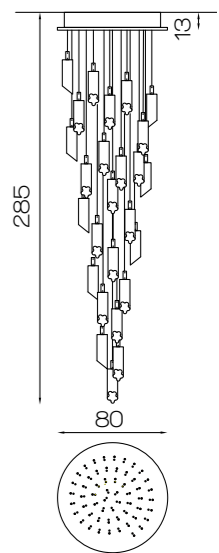
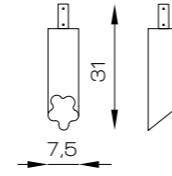



Art 1933
MU' RANO GLAS S BAMBU'
ø 56 cm H 285 cm
15 x E14 x 40W

Art 1933 LED
MU' RANO GLAS S BAMBU'
ø 56 cm H 285 cm
57 LED 450W

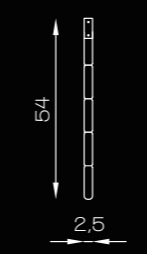

Waterfall of light and Murano's glass elements, decorative and amazing, are perfect for any interior.

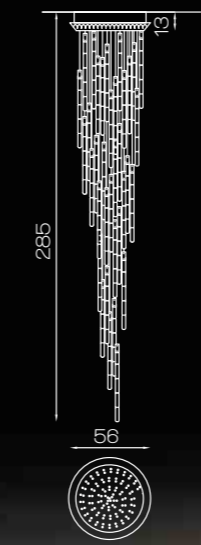

Art 1974
MU RANO GLAS S LEAF
ø 80 cm H 285 cm
15 x E14 x 40W

Art 1974 LED
MU RANO GLAS S LEAF
ø 80 cm H 285 cm 57 LED 450W

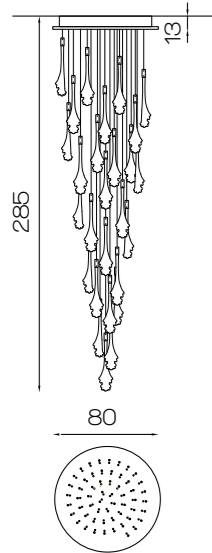
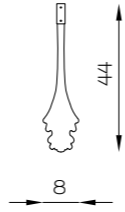



Art. 2002/A
 L 40 cm H 100 cm Sp 23 cm
 12 x LED 1,5W



Art 2002/G
 ø 25 cm H 60 cm
 10 x LED 1,5W + 2 x E14 x 40W



Art 2002/CH
 ø 30 cm H 200 cm
 20 x LED 1,5W





Art 1957 Le d
 MU' RANO GLAS S
 FLOW ER Sand BAMBU'
 ø 90 cm H 285 cm
 57 Le d 450W

Art 1957
 MU' RANO GLAS S
 FLOW ER Sand BAMBU'
 ø 90 cm H 285 cm
 15 x E14 x 40W

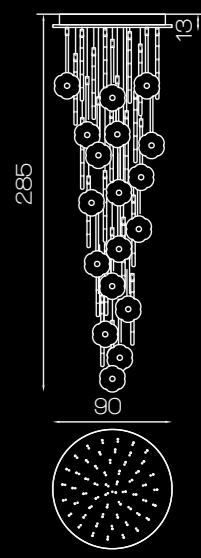
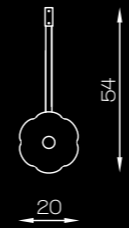

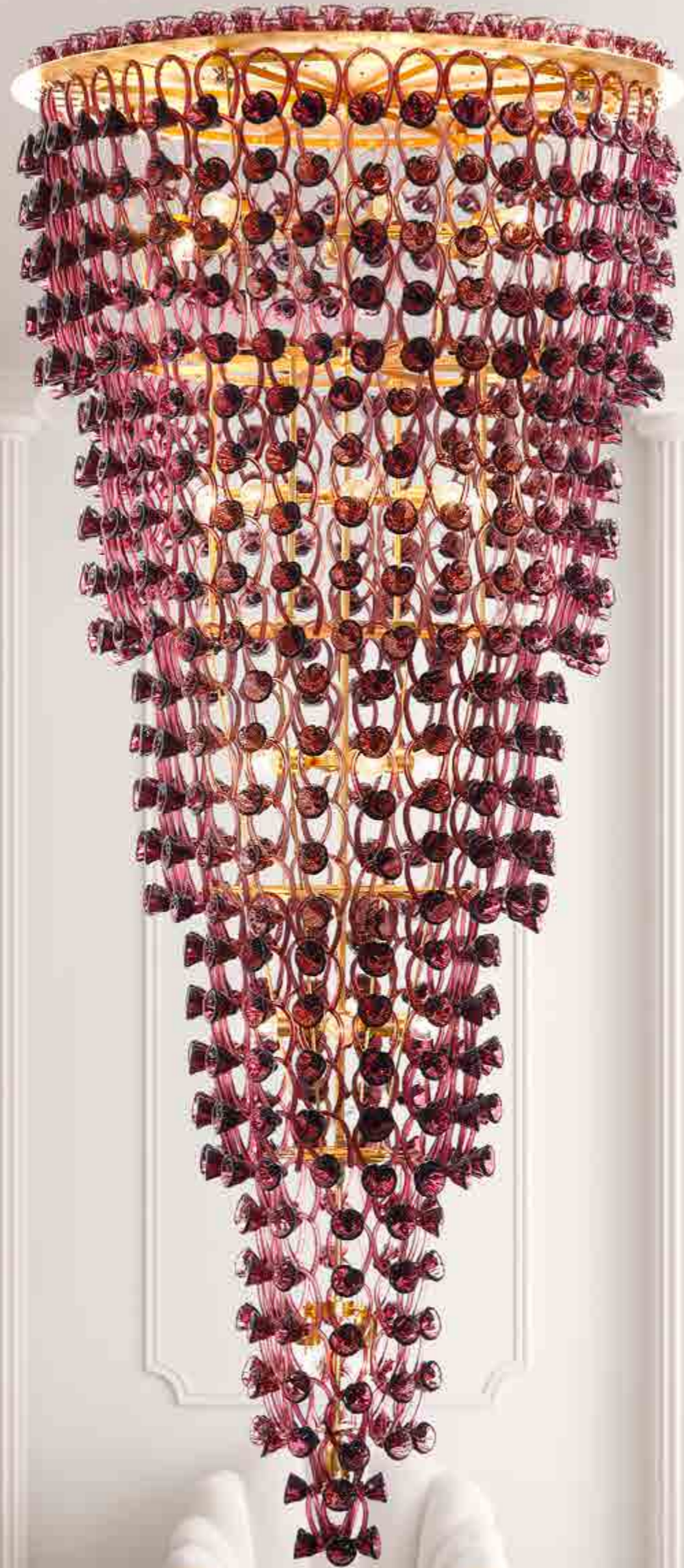

Art. 1874
 ø 120 cm H 300 cm
 30 x E14 x 40W



Art. 1618 Rectangular
 L 104 x 44 cm H 68 cm
 14 x E14 x 40W

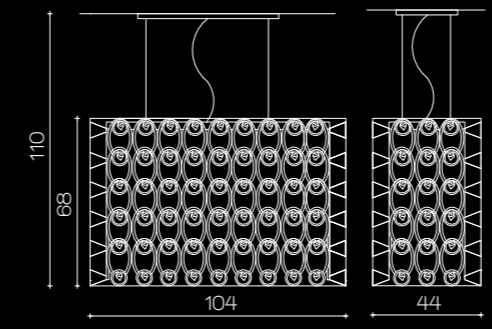

Cascata di rose in vetro di Murano trasparente e oro in struttura ottone lucido.

Art. 1618
 ø 50 cm H 130 cm
 7 x E14 x 40W



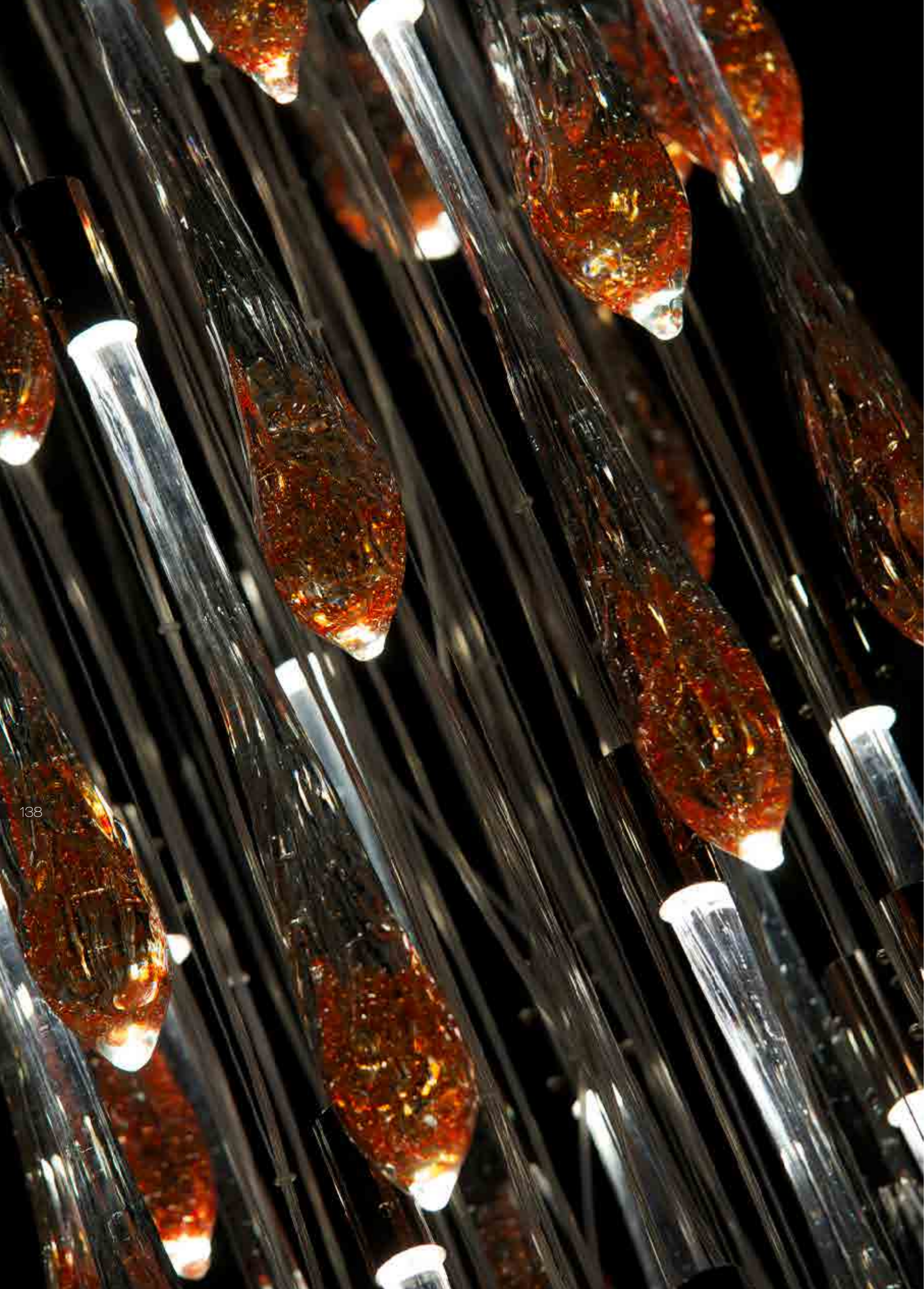

Art 1934
MU RANO RED DROP S
ø 56 cm H 275 cm
15 x E14 x 40W

Art 1934 LED
MU RANO RED DROP S
ø 56 cm H 275 cm
57 Le d 450W

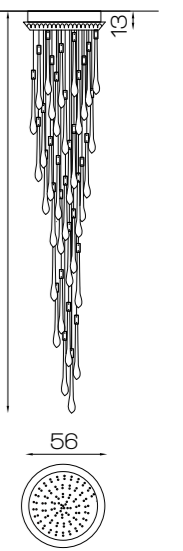
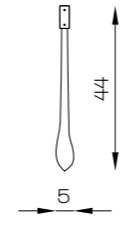



140



141



Il Paralume Marina

Art. 1810
ø 100 cm H 450 cm
40 x E14 x 25W

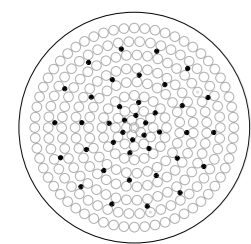
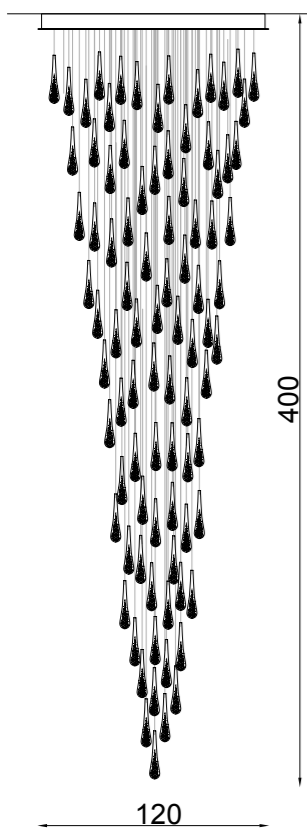

Art. 2023/CH40/LU
ø 120 cm H 400 cm
40 x E14 x LED 5W



Art. 2023/A2/LU
L 35 cm H 45 cm Sp 20cm
2 x E14 x 40W



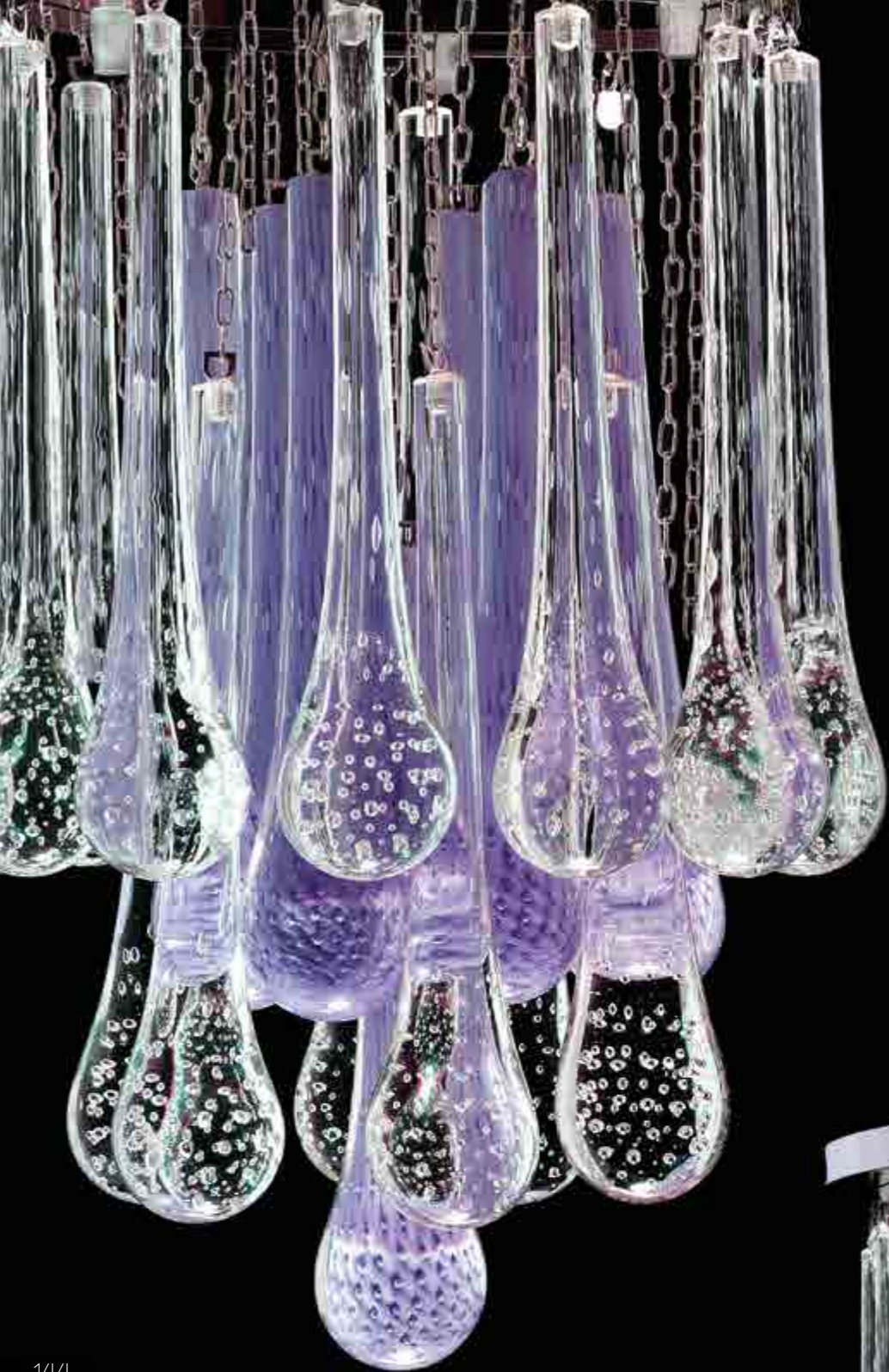

*Sospensione in vetro
di Murano soffiato*

Fixture in Murano
drops with interior little bubbles.

Плафон из Муранских
подвесок с внутренними пузырями.



Art.1359
ø 55 cm H 78 cm
8 x E14 x 60W

144

145



Il Paralume Marina

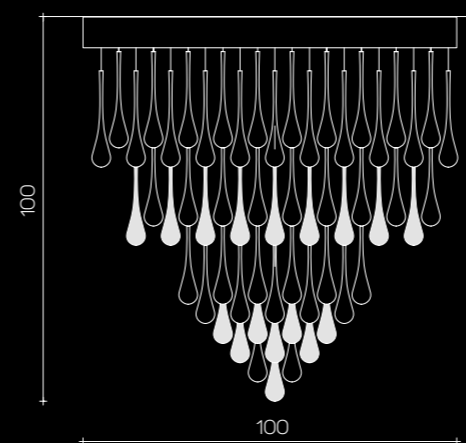

Art. 1615
ø 100 cm H 100 cm
16 x E14 x 60W

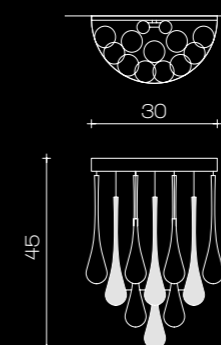

Art. 1359/A
H 45 cm L 30 cm
2 x E14 x 40W

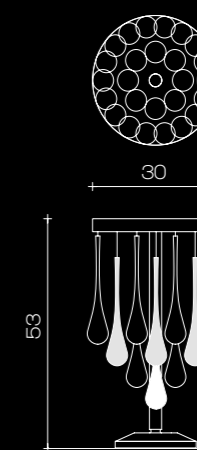

Art. 1359/TA
ø 30 cm H 53 cm
3 x E14 x 40W

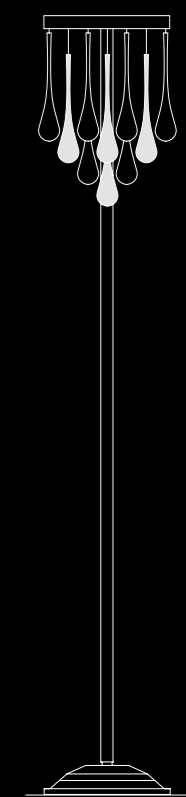

Art. 1359/FL
ø 30 cm H 180 cm
3 x E14 x 40W

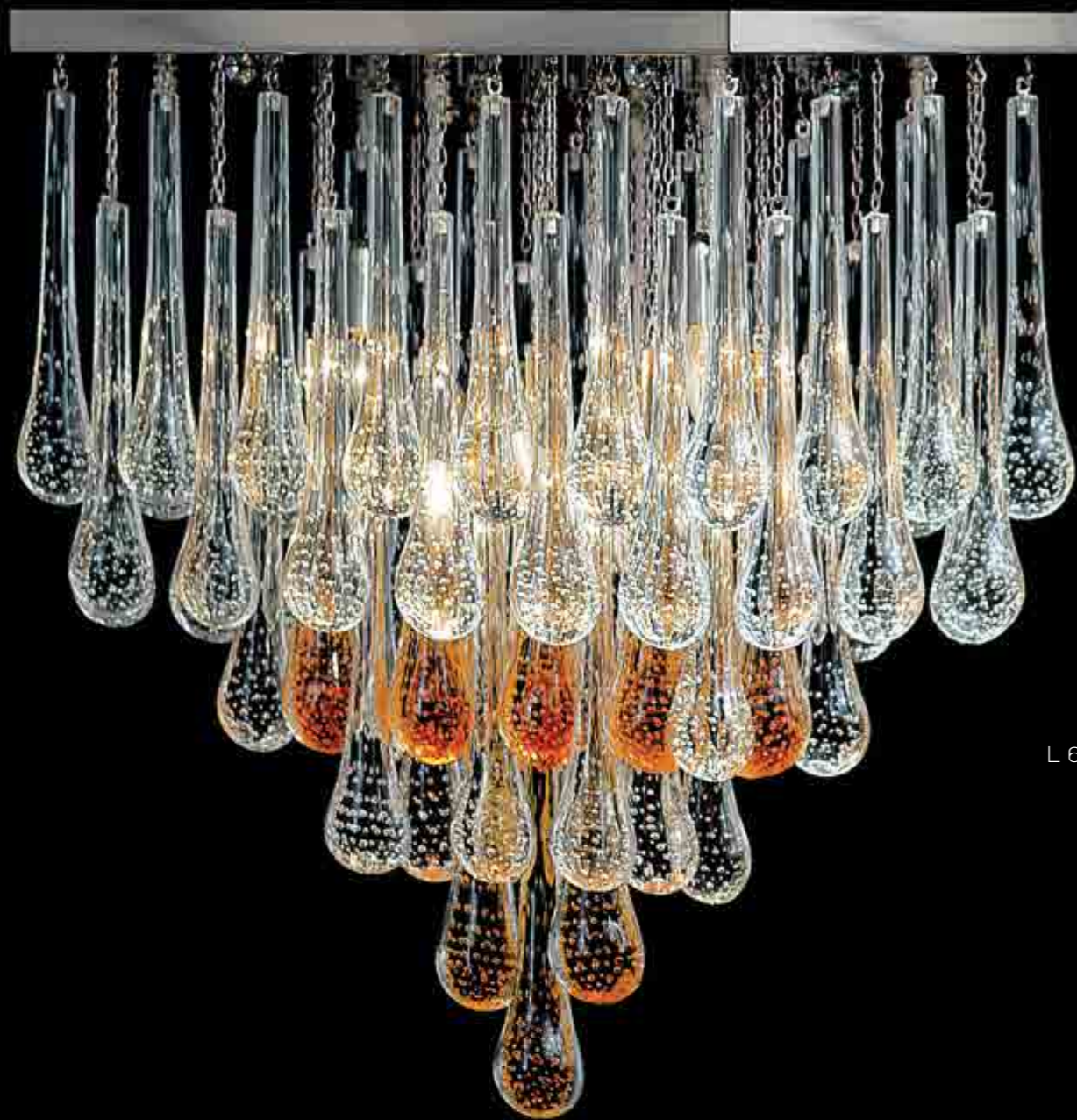

Art. 1692/KR/TR/AM
L 60 x 30 cm H 65 cm
8 x E14 x 40W



Art. 1693KR/TR/NR
L 60 x 30 cm H 65 cm
8 x E14 x 40W

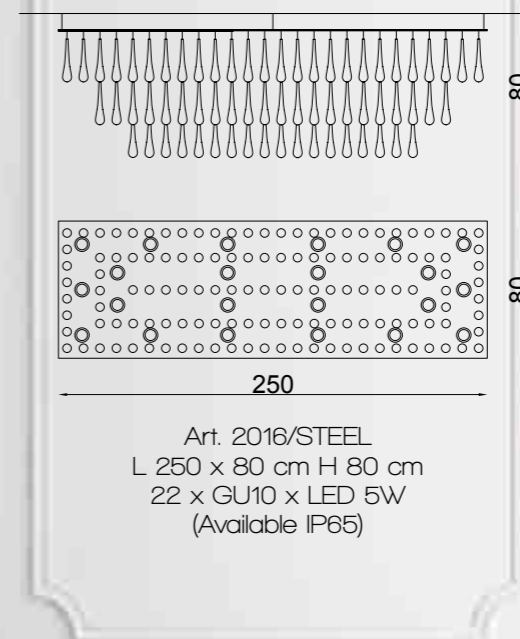
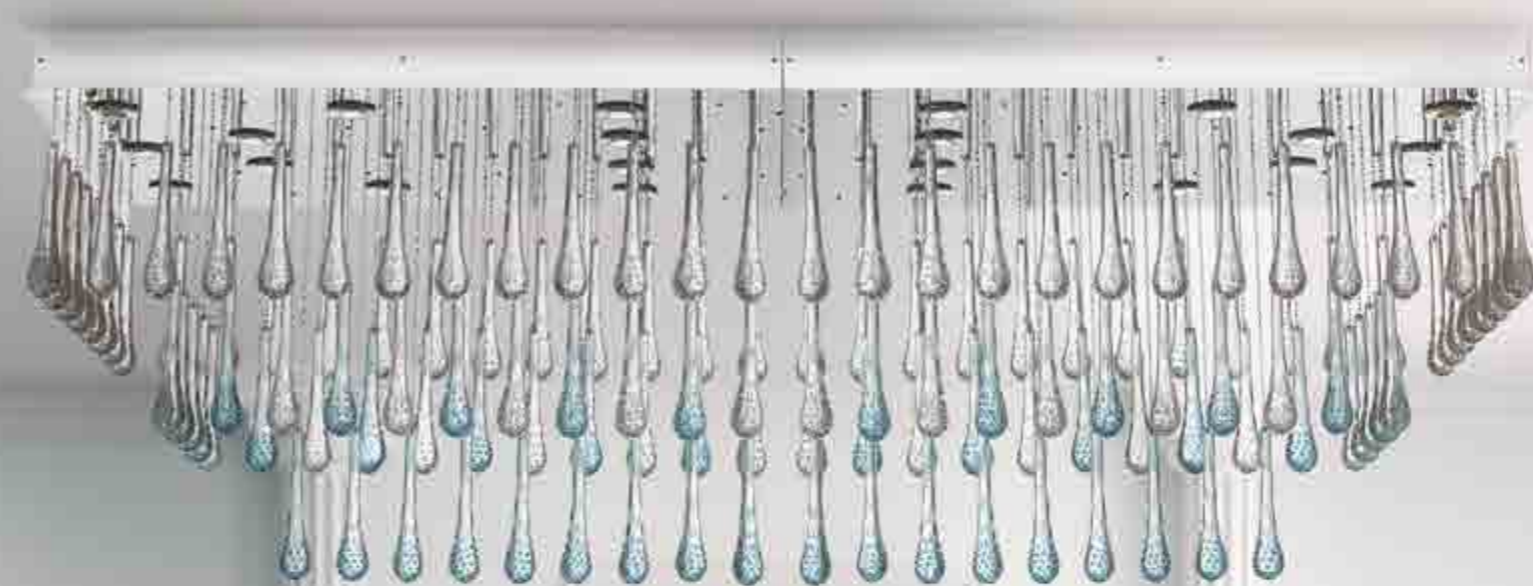

Art. 2016/STEEL
L 250 x 80 cm H 80 cm
22 x GU10 x LED 5W
(Available IP65)





Art.2025/CH9/NN
ø 65 cm + chain 50 cm
9 x E14 x LED 5W



Art. 2098/NL
Ø 65 cm H 39 cm
6 x E14 x Led 5 W



Art. 2024/CH9/LU
ø 65 cm + chain 50 cm
9 x E14 x LED 5W



Art. 2029/CH30/LU
ø 70 cm H 300 cm
35 x E14 x LED 5W



Art. 2029/A/LU
L 36 cm H 70 cm
3 x E14 x 40W



Art.1963/NL
ø 100 cm H 70 cm
14 x E14 x 60W

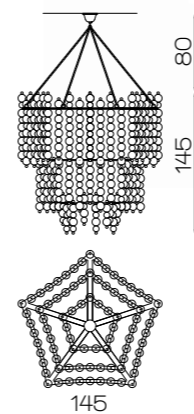

Art 1980/LU /TR
ø 145 cm H 145 cm
+ 80 cm c hain
30 x E14 x 40W



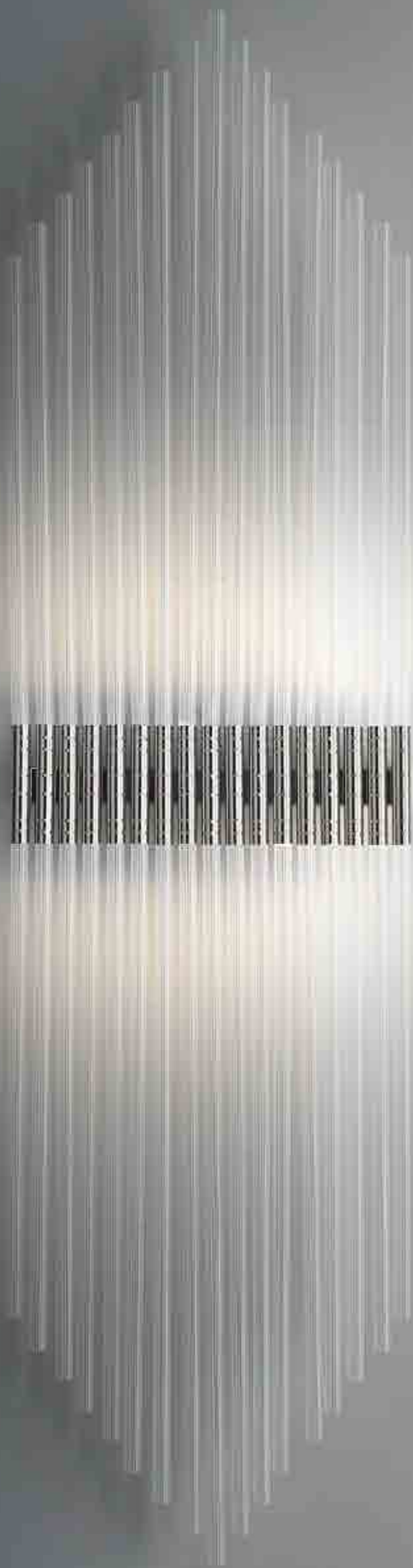

Art 1991
L 50 cm H 200 cm
Sp 11 cm
10 x E14 x 40W

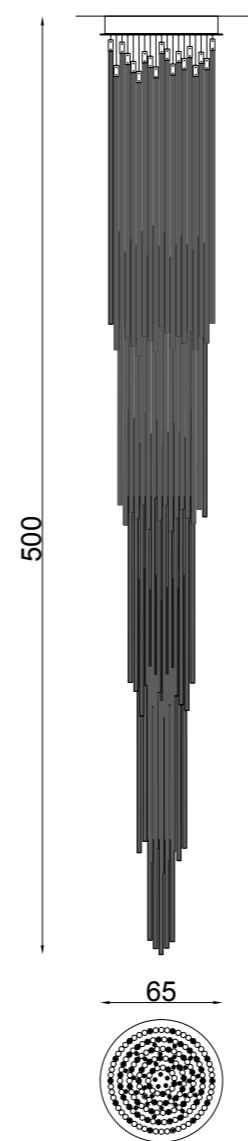

Lampadario a cascata di tubi
di plexiglass trasparenti

Art 1990
ø 65 cm H 500 cm
60 x LED 1,5W
+ 45 x E14 x 40W





Art. 1993
ø 70 cm H 50 cm
8 x E14 x 40W



Art. 2033/A/NL
ø 11 cm H 33 cm Sp 15 cm
2 x E14 x LED 5W



Art 1992
ø 120 cm H 55 cm
20 x E14 x 40W



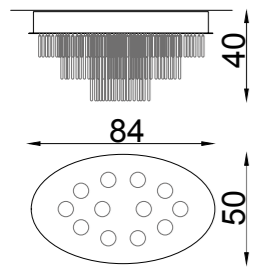

Art. 2027/OVALE/STEEL
 L 84 x 50 cm H 40 cm
 12 x GU10 x LED 10W
 (Available IP65)

Art. 2026/A/STEEL
 L 40 cm H 30 cm Sp 24 cm
 2 x GU10 x LED 10W
 (Available IP65)

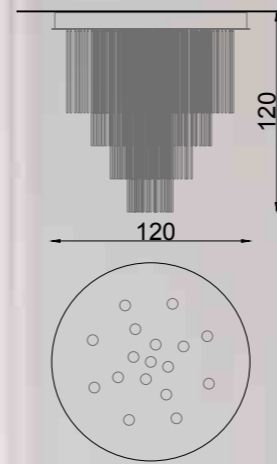

Art. 2026/STEEL
 ø 120 cm H 120 cm
 17 x GU10 x Led 10W
 (Available IP65)



Rain

Ceiling lamp with transparent, fume' and gold Murano glass drops is fit for bright installations of great scenic effect.

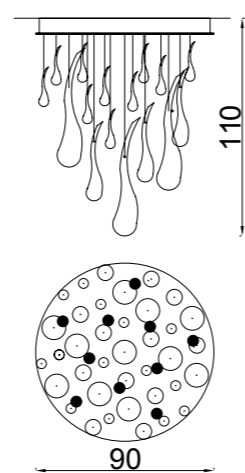

Art. 2063/Steel
Ø 90 cm H 110 cm
10 x GU10 x 40W
(Available IP65)

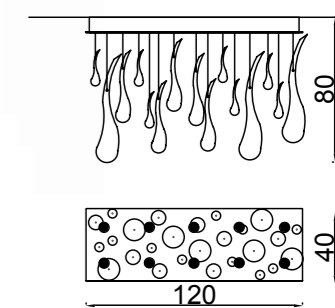

Art.2062/Steel
L 120 x 40 cm H 80 cm
10 x GU10 x 40W
(Available IP65)



The giant
This Cascade of three giant
drops creates attractive lighting
effect. It is the best expression
of the excellence of high
Murano craftsmanship.

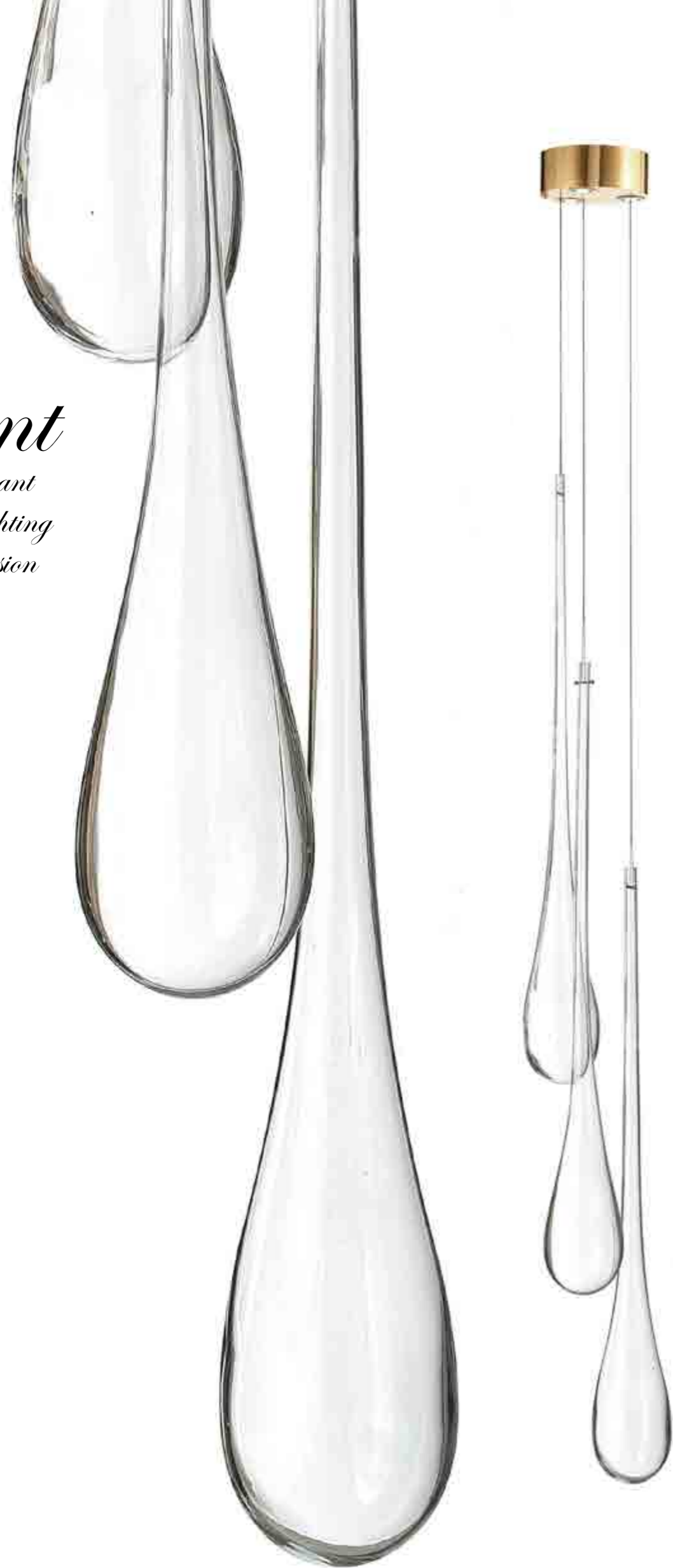

Art. 2105/LU
ø 60 cm H 315 cm
ceiling plate ø 30cm H 11 cm
3 x GU10 x 50W



Murano glass flowers made with different textures fly sinuously in the space. The designer played with antique working techniques of Murano glass: "Balaton", "Pulegoso", "a Fili" and "a Bolle" creating a striking but delicate composition.

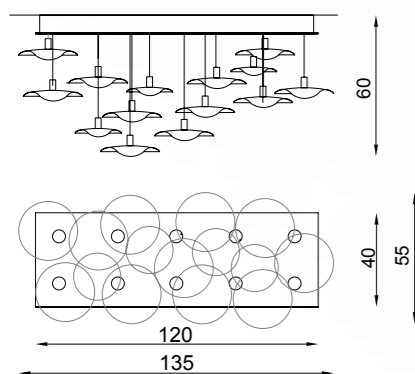

Art. 2059/Steel
L 135 x 55 cm H 60 cm
10 x GU10 x 40W
(Available IP65)

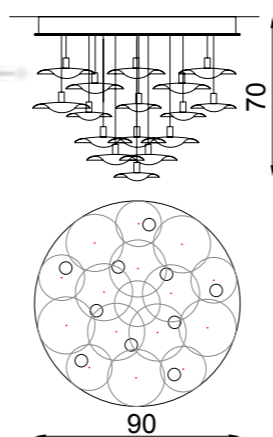

Art. 2060/Steel
Ø 90cm H 70 cm
10 x GU10 x 40W
(Available IP65)

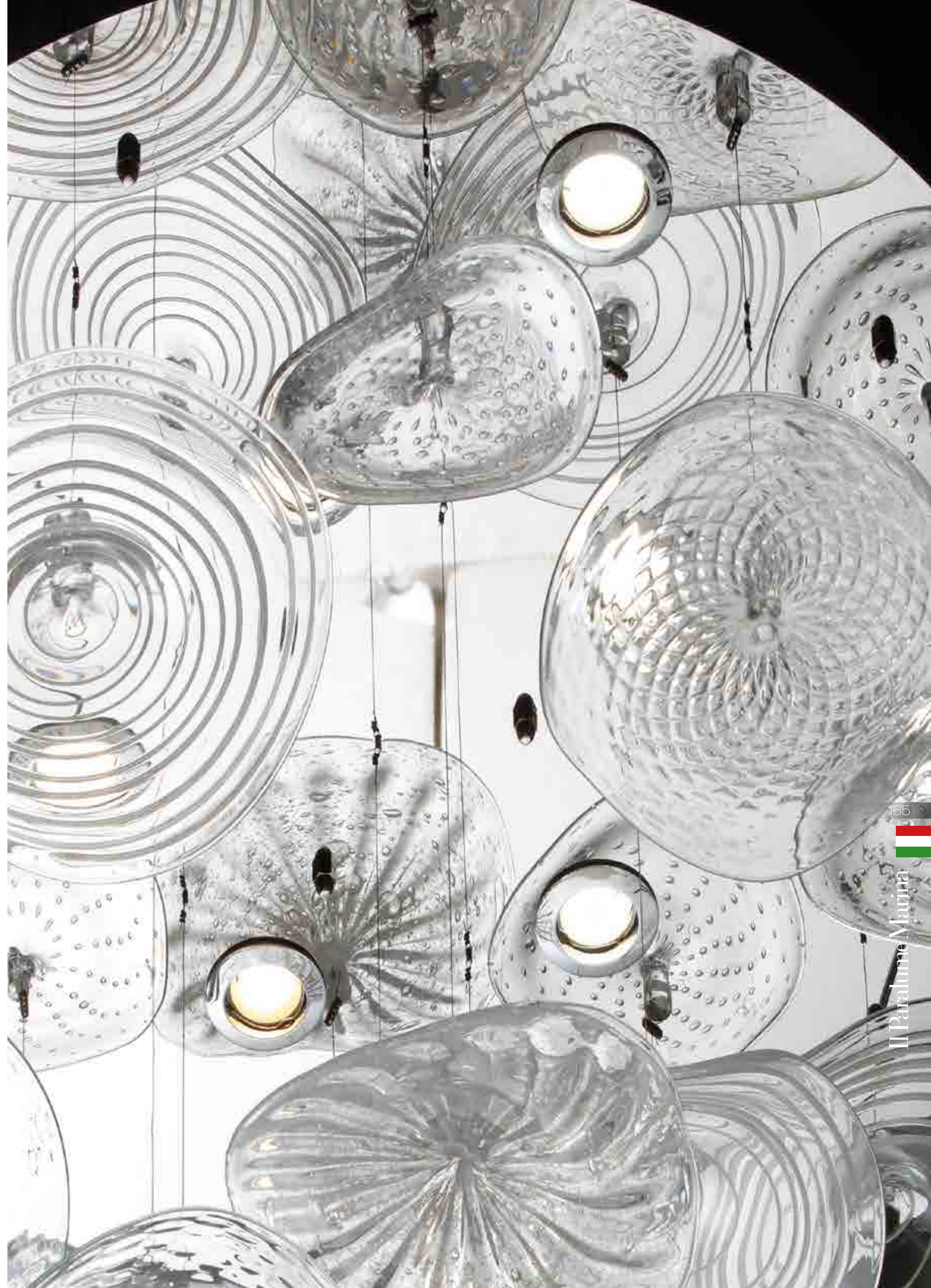



*Ceiling lamp with
Swarovski Elements*

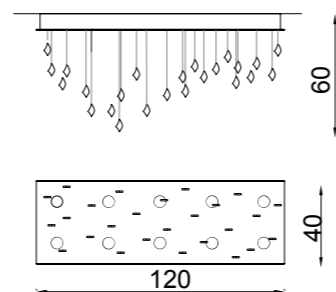

Art. 2083/Steel
L 120 x 40 cm H 80 cm
10 x GU10 x 40W
(Available IP65)

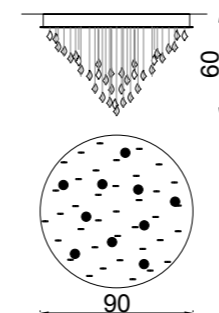

Art. 2084/Steel
D 90 cm H 60 cm
10 x GU10 x 40W
(Available IP65)





168

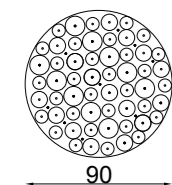
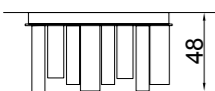

Art. 2078/Steel
 ø 90 cm H 48 cm
 18 x G9 x 25W Steel

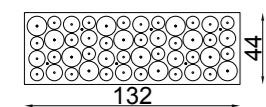
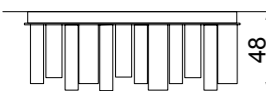

Art. 2077/Steel
 L 132 x 44cm H 48 cm
 18 x G9 x 25W Steel

169



Constellations

*Plafond / wall sconce
with circle of glass and
silver leaf.*



170

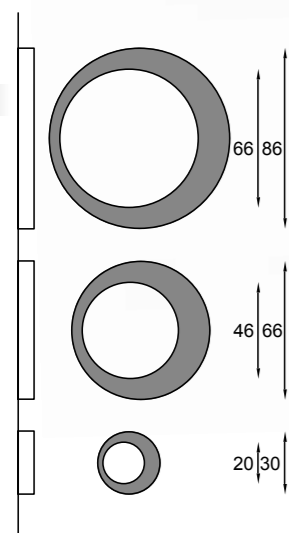

Art. 2107/G/NL
ø 86 cm Sp 8 cm
6 x G9 x 5W Led

Art. 2107/M/NL
ø 66 cm Sp 8 cm
3 x G9 x 5W Led

Art. 2107/P/NL
ø 30 cm Sp 8 cm
2 x G9 x 5W Led

171





Cloud

*Ceiling lamp with
oval bracelets of
"pulegoso" glass creates
a great and exciting
aesthetic impact.*

Art. 2108
L 120 cm H max 64 cm
Strip Led 3000K
Lumen 1800/m 18W

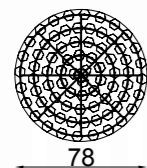
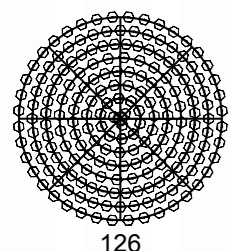
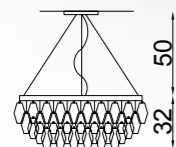
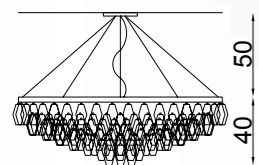

Art. 2081/NL
 ø 126 cm H 40 cm
 +50 cm steel cable
 16 x E14 x 40W

Art. 2082/NL
 ø 78 cm H 32 cm
 +50 cm steel cable
 8 x E14 x 40W

Art. 2080/A/NL
 L 45 cm H 55 cm Sp 19cm
 3 x E14 x 40W



Art. 2080/RETT/NL
 L 117 x 40 cm H 55 cm
 +100 cm steel cable
 12 x E14 x 40W



176



177

Il Paralume Marina

Art 1936
Ø 150 cm H 75 cm
+ Ceiling plate H 10 cm Ø 21 cm
14 x E27 x 60W

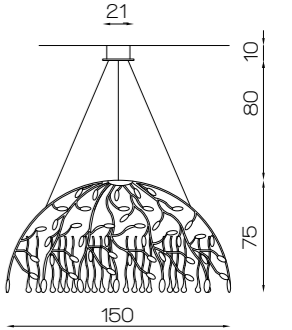



*Rings with led with
Swarovski Elements*

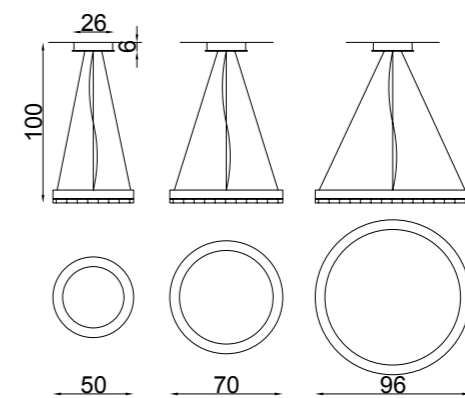

Art. 2103/P/NN
 ø 50 cm H 8 cm
 100 cm steel cable
 Strip Led 3200 K
 Lumen 3240 43W

Art. 2103/M/NN
 ø 70 cm H 8 cm
 100 cm steel cable
 Strip Led 3200 K
 Lumen 4860 64W

Art. 2103/G/NN
 ø 96 cm H 8 cm
 100 cm steel cable
 Strip Led 3200 K
 Lumen 7020 93W

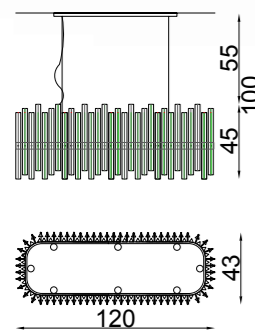

Art. 2054/RETT/NN
L 120 x 43 cm H 45cm
+55 cm Steel cable
16 x E14 x 40W

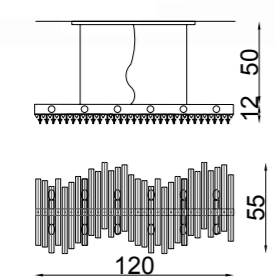

Art.2055/NN
L 120 x 55 cm H 12 cm
+50 cm Steel cable
12 x E14 x 40W

Art. 2054/CH16/NN
ø 100 cm H 45cm
100 cm Steel cable
16 x E14 x 40W

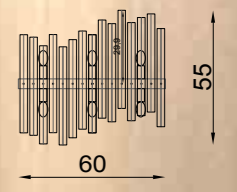

Art. 2054/A/NN
L 60 cm H 55 cm Sp12 cm
6 x E14 x Led 5 W

Art. 1638/KR/FUME'
L 49 x 22 cm H 37 cm
2 x E27 x 60W



Art. 1638/AM/LU
L 49 x 22 cm H 37 cm
2 x E27 x 60W



Art.1638/A
L 40 cm H 20 cm
Sp 13 cm
2 x E14 x 60W



Stecca di vetro di Murano
Trasparente - Fumè - Ambra

Art.1638/CH2
L 49 x 22 cm H 117 cm
2 x E27 x 60W

Art.1638/FL
L 49 x 22 cm H 152 cm
6 x E27 x 60W





Art. 2031/CH9/NL
Ø 95 cm + chain 50 cm
9 x E14 x Led 5W

Art 2030/CH9/NL
ø 95 cm H 45 cm
c hain 50 cm
9 x E14 x Le d 5W



Art 2030/A
ø 75 cm H 34 cm
6 x E14 x Le d 5W



Art. 2042/LU
ø 41 cm H 64 cm
1 x E14 x 40 W



Art. 1997
L 26 cm H 62 cm
Sp 13 cm
4 x E14 x 40W



Art 1995
Ø 80 cm H 55 cm
8 x E27 x 60W

Available:
Art 1996
Ø 50 cm H 50 cm
6 x E27 x 60W



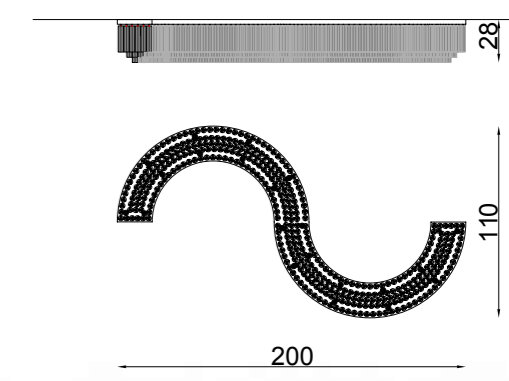

Il Paratume Marina

193

Art 2020/LU
L 200 x 110 cm H 28 cm
27 x E14 x Le d 5W

192



Art. 1512
L 120 x 60 cm H 60 cm
12 x E14 x 40W



Art 2019
L 140 cm x 80 cm H 60 cm
18 x E14 x 25W



"Arte Brotto"

Art.1660
ø 85 cm H 100 cm
14 x E14 x 60W



Art.1562
ø 70 cm H 40 cm
10 x E14 x 40W

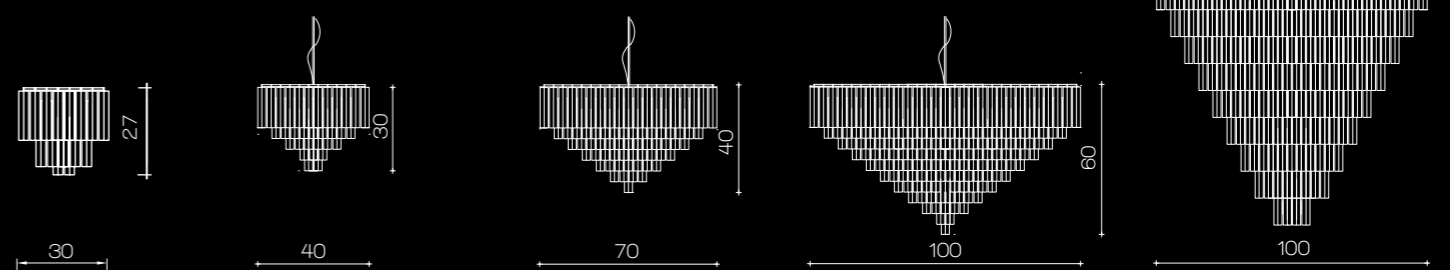

ART. 1561/A/bis
H 27 cm ø 30 cm
2 x E14 x 60W

Art.1561
ø 40 cm H 30 cm
8 x E14 x 40W

Art.1562
ø 70 cm H 40 cm
10 x E14 x 40W

Art.1563
ø 100 cm H 60 cm
14 x E14 x 40W

Art.1564
ø 100 cm H 100 cm
14 x E14 x 40W





Art.1691/KR/TR
 ø 50 cm H 80 cm
 10 x E14 x 40W



Art.1887
 ø 100 cm H 207 cm
 14 x E14 x 40W
 6 x E27 x 60W



200

Это не просто водопады кристаллов Swarovski Elements, это изделия, которые зажигают не только свет, но и эмоции. Они универсальны и предоставляют широкий спектр возможностей по персонализации. Изготовленные вручную, бабочки из муранского стекла по праву считаются ювелирными изделиями осветительных приборов.

Art. 1796
ø 53 cm H 145 cm
12 x E27 x 60W

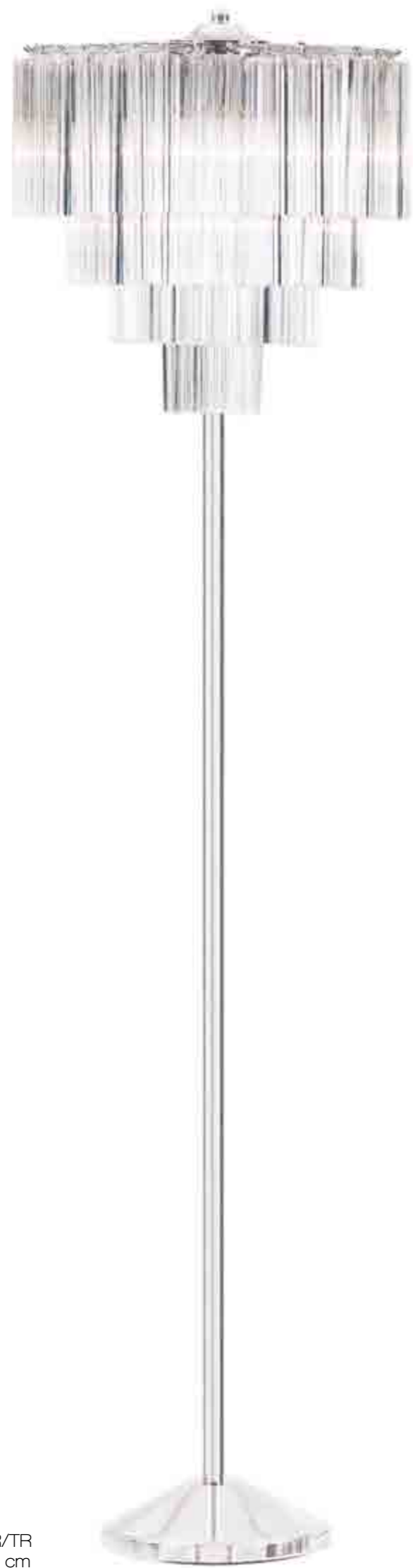

Art. 1691/FL/KR/TR
ø 60 cm H 178 cm
4 x E14 x 40W



Art. 1691/P/KR/TR
ø 20 cm H 45 cm
2 x E14 x 40W

Art. 1691/G/KR/TR
ø 30 cm H 63 cm
3 x E14 x 40W



Art. 1998
L 28 cm H 56 cm
Sp 18 cm
3 x E14 x 40W





Art. 1611/CH1
ø 28 cm H 42 cm
1 x E27 x 100W

Art. 1610/CH6
ø 42 cm H 69 cm
6 x E27 x 60W

Art. 1614/CH11
ø 70 cm H 105 cm
11 x E27 x 60W



Art. 1611/TA
ø 28 cm H 42 cm
1 x E27 x 100W

Art. 1610/TA
ø 42 cm H 69 cm
6 x E27 x 60W

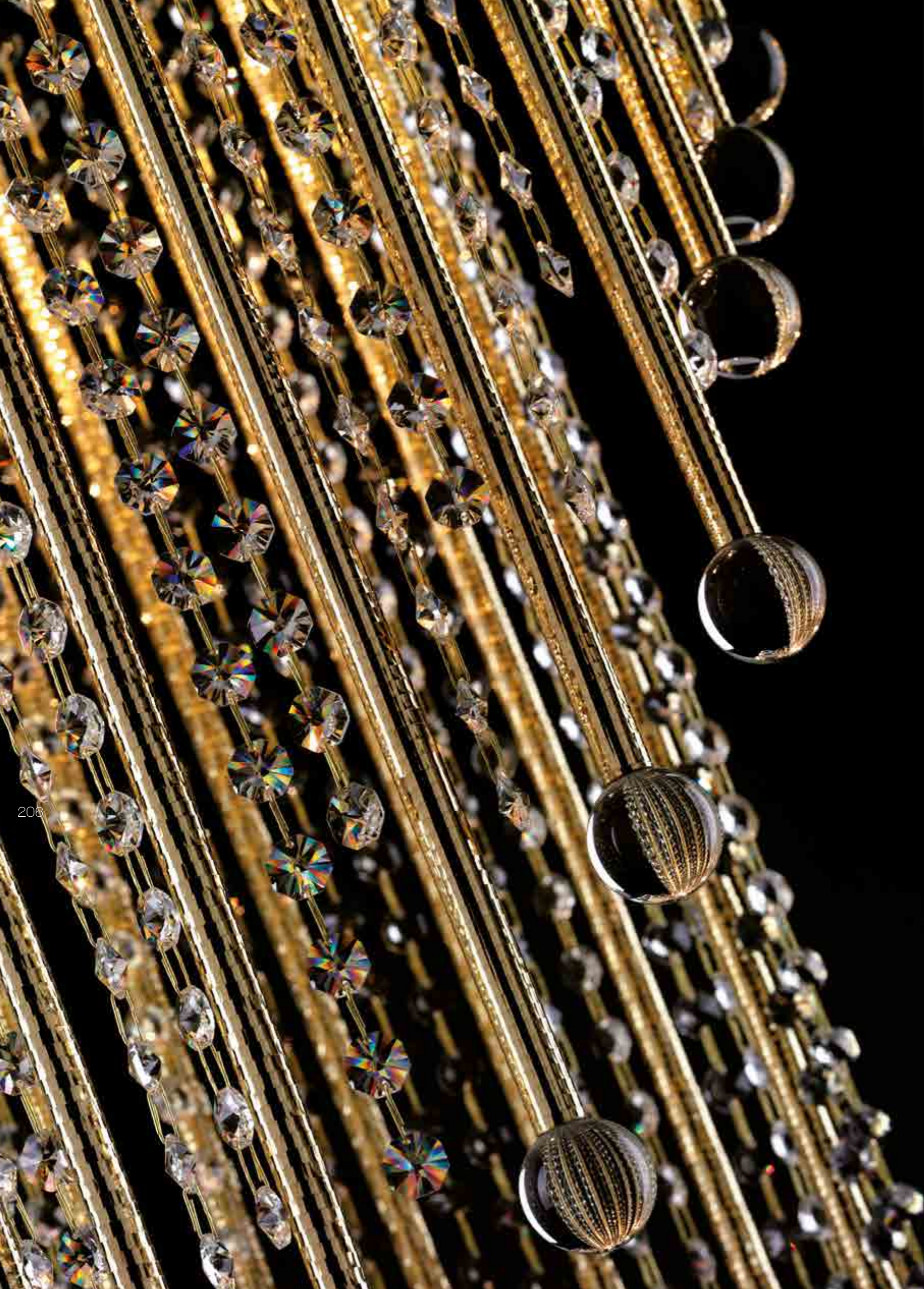

*Cascata con tubo
diamantato in ottone
lucido, palline di
Murano e file di
Swarovski.*

A cascade of polished brass
diamond cutted, Swarovski rows
and Murano glass valls.

Каскад из трубок латуни
рядов Swarovski и шариков из
Муранского стекла.

Art1493
ø 55 cm H 270 cm
15 x E14 x 40W



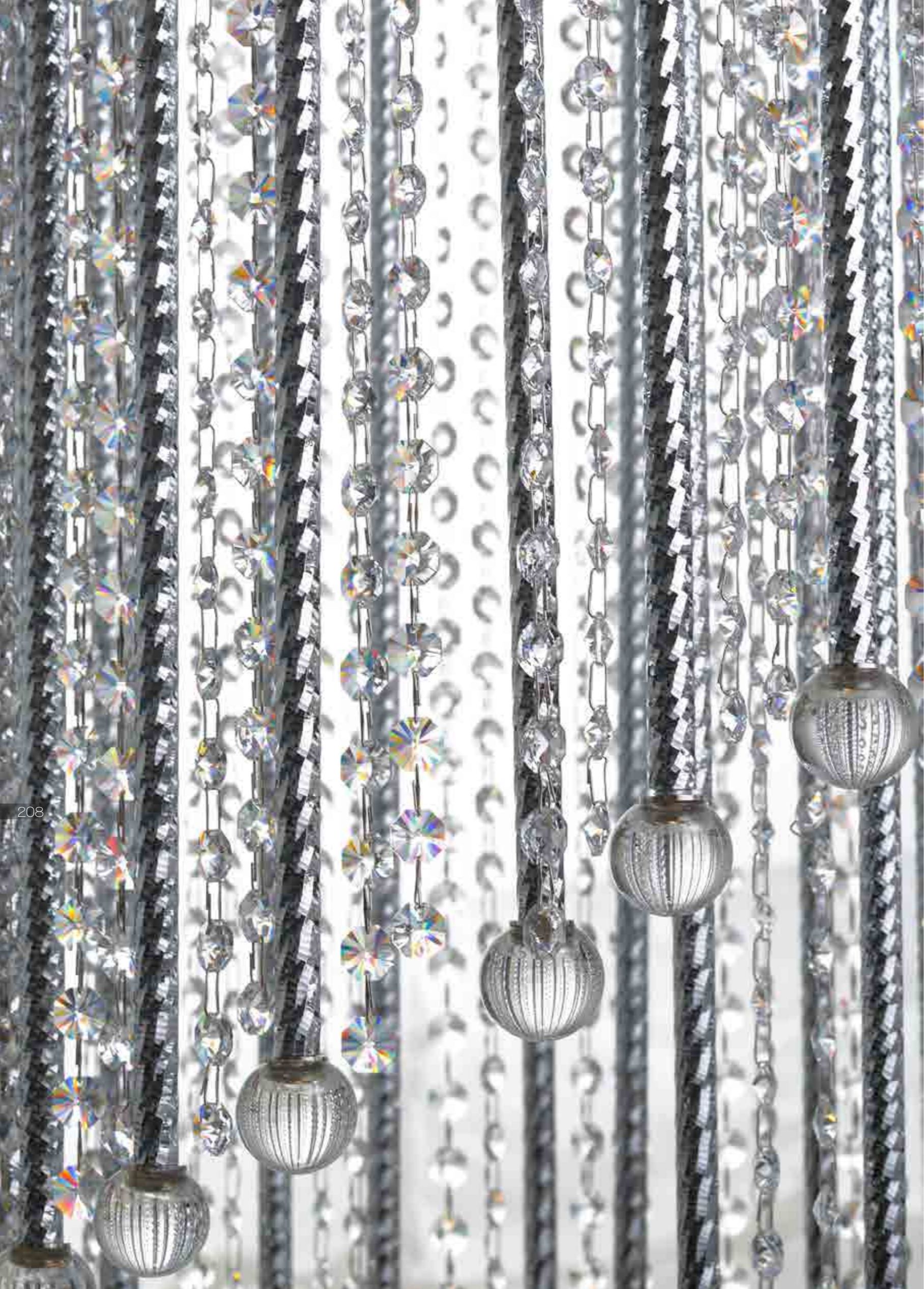

Art 1928
diamond TU BE BRAS S and
S W AROVSK pe traCRIS TAL
ø 110 cm H 440 cm
20 x E14 x40W



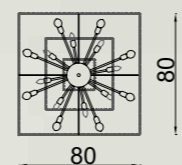
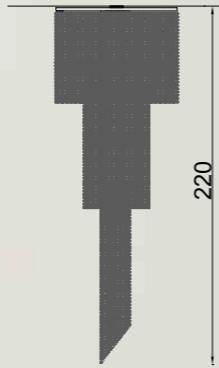

Art. 2022/NL
L 80 x 80 cm H 220 cm
16 x E14 x Led 5W

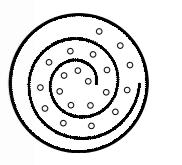

Art. 2017/BR
ø 100 cm H 350 cm
20 x E14 x Led 5W

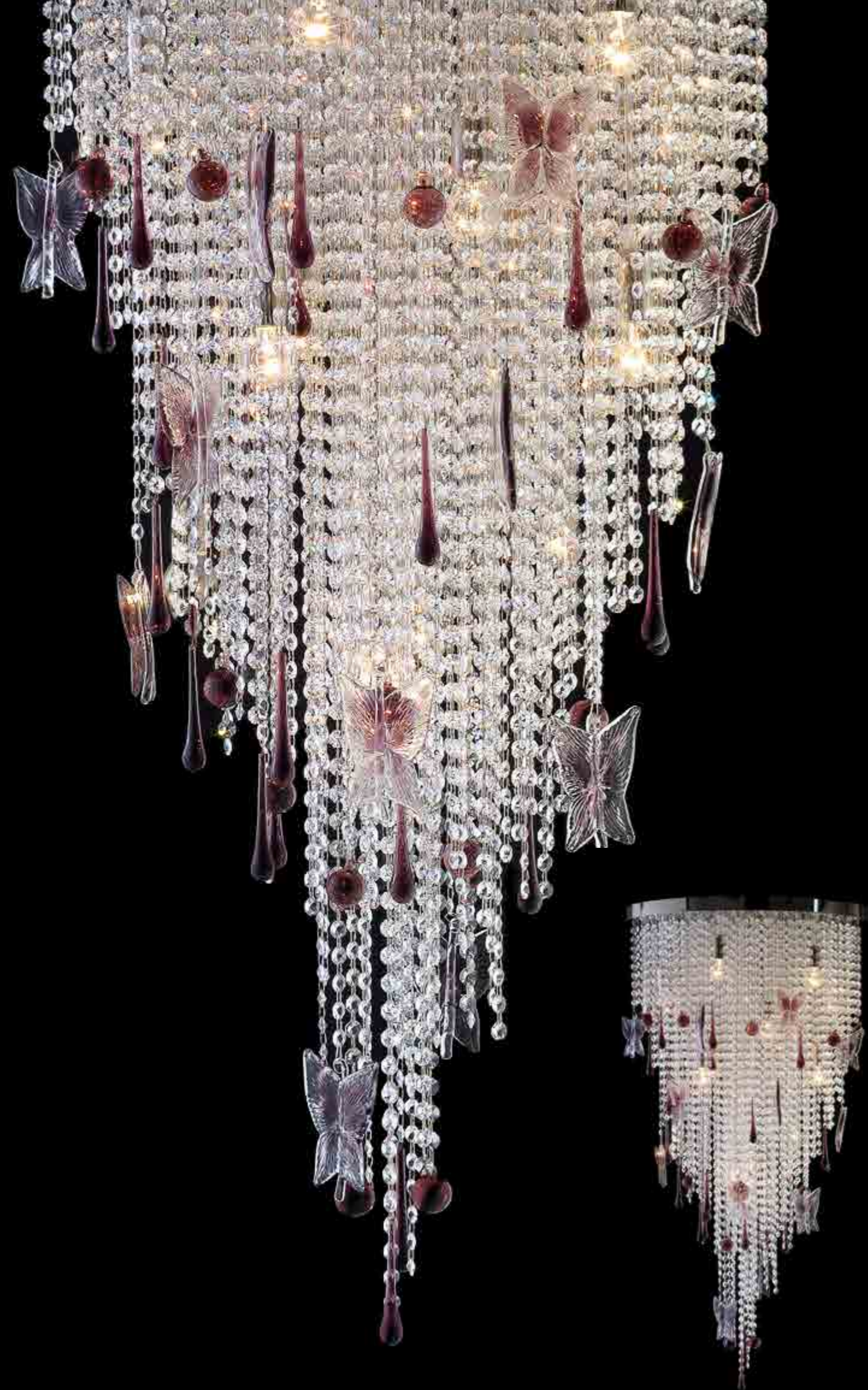

Art. 1808
 ø 60 cm H 120 cm
 12 x E14 x 40W



Art 2000
 ø 70 cm H 85 cm
 15 x E14 x 40W

Art. 2001
 ø 80 cm H 225 cm
 20 x E14 x 40W



Art. 1279
 ø 30 cm H 50 cm
 1 x E27 x 60W

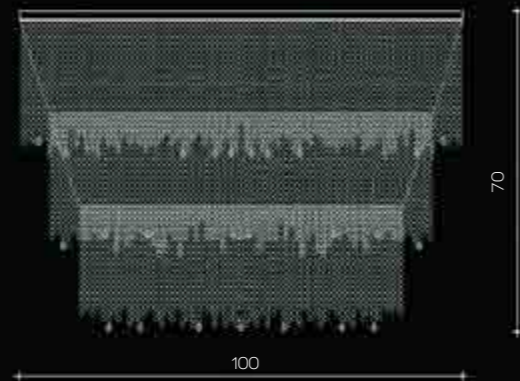

Art. 1535
 ø 100 cm H 70 cm
 12 x E14 x 60W

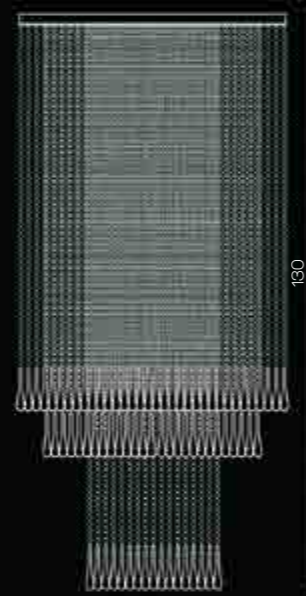

Art. 1536
 ø 60 cm H 130 cm
 12 x E14 x 60W

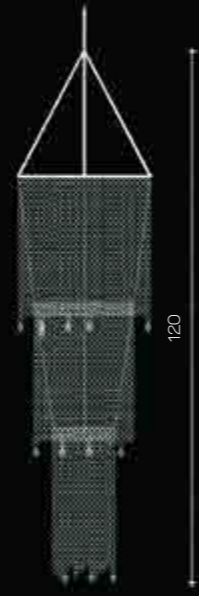

Art. 1534
 ø 30 cm H 120 cm
 8 x E14 x 60W

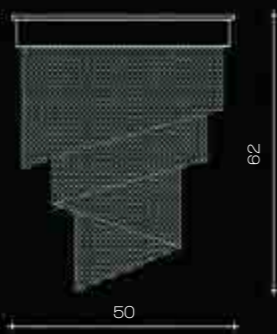

Art. 1537
 ø 50 cm H 62 cm
 10 x E14 x 60W



Art. 1538
 ø 30 cm H 270 cm
 12 x E14 x 60W

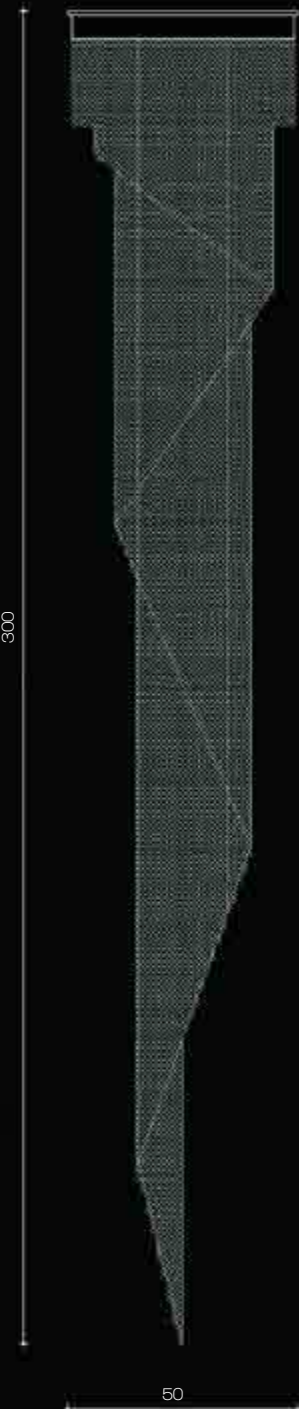

Art. 1379
 ø 50 cm H 300 cm
 12 x E14 x 60W



Art. 1701/P/OV/TR
 ø 30 cm H 70 cm
 4 x G9



Art.1379/B
 ø 50 cm H 80 cm
 3 x E14 x 60W



*Serie di
 scipensioni
 in ottagoni
 Swarovski.*

Art.1379
 ø 50 cm H 300 cm
 12 x E14 x 60W



216



Art. 1839
ø 45 cm H 30 cm
5 x G9 x 60W

217



Art. 1859/CH1/KR
ø 29 cm H 118 cm
1 x E27 x 60W

Il Paralume Marina





Art. 1702/KR/TR
ø 53 cm H 130 cm
13 x G9 x 25W

Art. 1701/KR/TR
ø 40 cm H 100 cm
8 x G9



Art. 1820/CH ovale
L 72 x 40 cm H 70 cm
4 x E27 x 60W

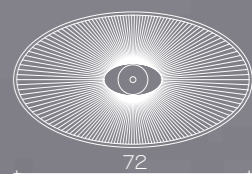
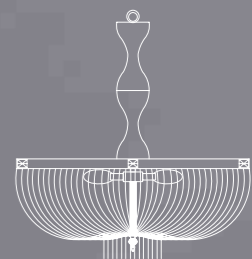



Art. 1807
Ø 80 cm H 60 cm
8 x E14 x 40W



ART. 1764
L 100 X 50 CM
H 60 CM
12 X E14 X 40W





Art.1764/A
L 25 cm H 50 cm
Sp15 cm
2 x E27 x 60W



Art. 2040/LU
L 100 x 25 cm H 45 cm
6 x E14 x LED 5W





Art. 2018/NL
 Ø 160 cm H 130cm
 +50 cm Steel cable
 20 x E27 x 40W

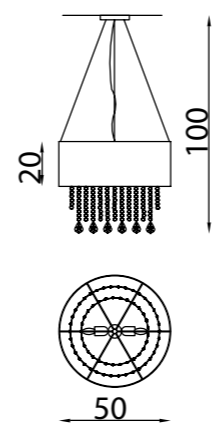

Art. 1386/CH2/NL
 Pø 50 cm H tot 100cm
 + 50 cm Steel cable
 2 x E27 x 60W

Art. 1386/CH4
 Pø 100 cm H 120 cm
 + 50 cm Steel cable
 4 x E27 x 60W



Art. 2052/NL
L 120 x 40 cm H 70cm
+ 100 cm Steel cable
6 x E14 x 40W



Art. 2064/LU/SP
L 70 x 70 cm H 55cm
Htot 155cm
4 x E14 x 60W

Milano Design Week 2016
fmfateller.com



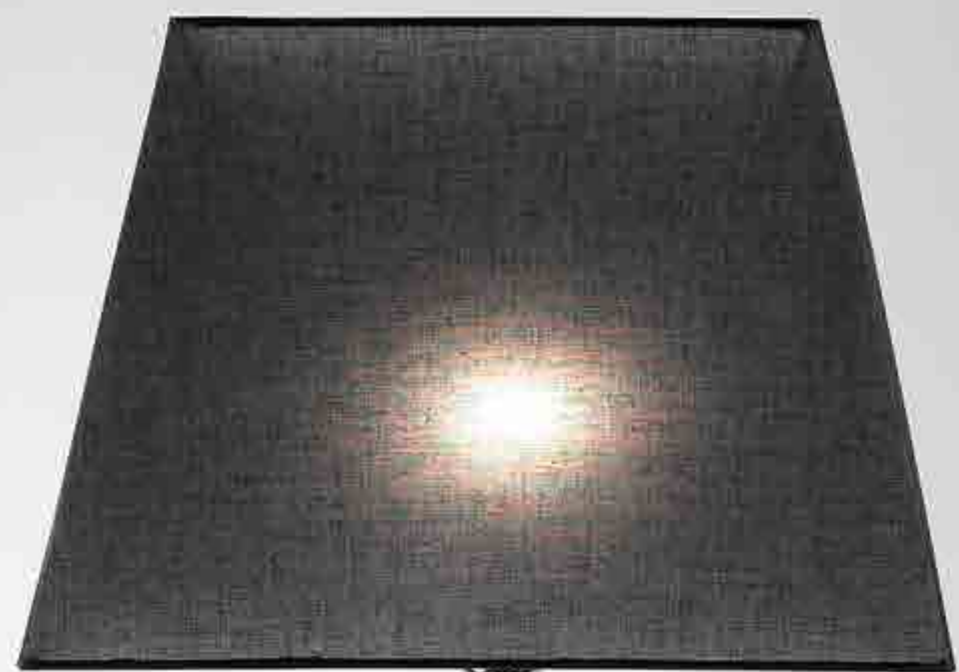

Art.1504/G
L 35 cm H 65 cm
1 x E27 x 60W



Art.1504/P
L 16 cm H 40 cm
1 x E14 x 40W



Paralume quadro con
organza grigia e file di
Swarovski viola.

Art.1271/FL/BIS
PL 40 cm H 175 cm
1 x E27 x 60W





Art. 1271/FL gius
Pø 50 cm H 180 cm
1 x E27 x 100W



Art. 1227/A
ø 40 cm H 119 cm
2 x E27 x 60W

Art. 1271/M
Pø 25 cm H 63 cm
1 x E14 x 60W



Art.1299
ø 50 cm H 80 cm
1 x E27 x 60W



Art. 1271/T
ø 30 cm H 75 cm
1 x E27 x 60W

Art. 1271/FL
ø 50 cm H 180 cm
1 x E27 x 60W





Art. 1258/S
ø 20 cm H 65 cm
1 x E27 x 60W



Art. 1190
ø 30 cm H 190 cm
4 x E27 x 60W



Art. 1367
ø max 20 cm H 175 cm
2 x E14 x 60W



Art. 1258
ø 20 cm H 77 cm
1 x E27 x 60W



Art. 1259
ø 20 cm H 68 cm
2 x E14 x 60W



Lampade da terra in tubo calandrato, finiture disponibili: cromato, bianco o finito in oro 24k, librano armoniosamente emozioni e pensieri con la loro leggerezza ed eleganza di forme. I paralumi vivaci e ricercati donano un tocco contemporaneo.

The collection of the floor lamps with calendered chromed tube white or in 24K gold colour inspire emotions and thoughts with it's lightness and elegance of the forms. It's sophisticated lampshades have a lively contemporary touch.

Эта коллекция напольных ламп в отделках под хромированный металл, белый или под золото 24 карата удивляет лёгкостью и элегантностью форм. Утонченные абажуры придают ей стильный современный вид.

Art. 1680/FL/KR
L 230 cm H 240 cm
Pø 80 cm
1 x E27 x 100W

Art. 1812/BI
L 230 cm H 240 cm
Pø 80 cm
1x E27 x 100W

Art. 1813/LU
L 230 cm H 240 cm
Pø 80 cm
1 x E27 x 100W

235



Il Paralume Marina



236

Art. 1812/BI
L 230 cm H 240 cm
Pø 80 cm
1 x E27 x 100W



237

*Marina lampshades, leader
in creating customized light.*

Фабрика Il Paralume Marina
является лидером в
производстве светильников по
заказу клиента.

Art. 2102/NL
ø 80 cm H 38 cm
+100 cm Steel cable
4 x E27 x 60W



Art.1227
ø 50 cm H 80 cm
2 x E27 x 40W

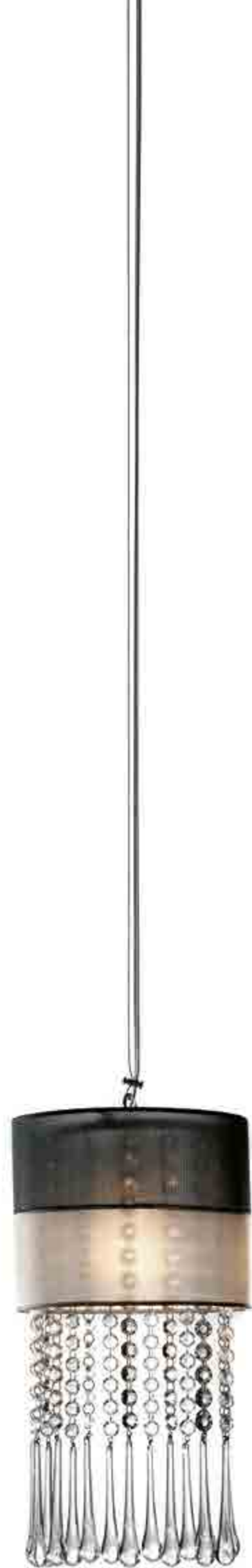

Art.1226
ø 20 cm H 40 cm
1 x E27 x 60W



Art.1219
ø 40 cm H 160 cm
1 x E27 x 60W



Art.1216
ø 40 cm H 70 cm
1 x E27 x 60W

Art. 1604/P
Pø 23 cm H 56 cm
1 x E27 x 60W



Art. 1604/FL
Pø 44 cm H 180 cm
1 x E27 x 100W



Art. 1604/A
Pø 20 cm H 100 cm
1 x E14 x 40W

Art. 1604/G
Pø 35 cm H 70 cm
1 x E27 x 60W



Art. 1604
Pø 48 cm H 80 cm
1 x E27 x 100W





Art. 2112
Ø 110 cm H 14 cm
5cm on ceiling
(included 50 cm steel cable)
6 x G9 x 5W Led



Art. 1891
H 80 cm PØ 45 cm
1 x E27 x 60W



Art. 2113/LU
L 92 x 45 cm H 30 cm
5cm on ceiling
(included 50 cm steel cable)
Pannelo Led 3000K Lumen
4649 36W



Art. 2099/LU
L 94 x 48 cm H 7 cm
+ 50 cm steel cable
Ceiling base 30 x 8 x 8 cm
Pannelo Led 3000K
Lumen 4649 36W



Art. 2111
ø 60 cm H 38 cm
100 cm steel cable
1 x E27 x 60W



Art. 2094/NN
Pø 35 cm H60 cm
1 x E27 x 40 W



Art. 2110
ø 60 cm H 28 cm
100 cm steel cable
1 x E27 x 60W



Art. 2109
ø 80 cm H 34 cm
1 x E27 x 60W



Paralume in chiffon
arricciato avorio.

Art. 1513
Pø 100 cm H 44 cm
4 x E27 x 60W



Art. 1070
Pø 70 cm H 55 cm
6 x E14 x 25W

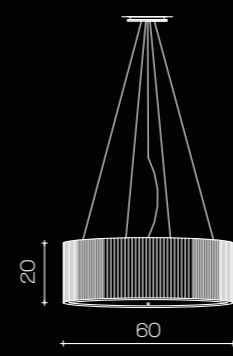

Art.1513/1

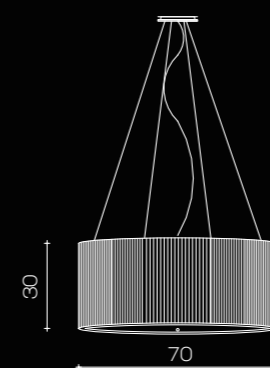

Art.1513/2

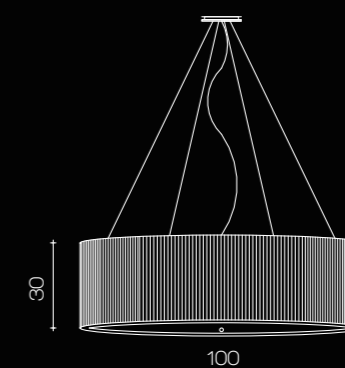

Art.1513/3

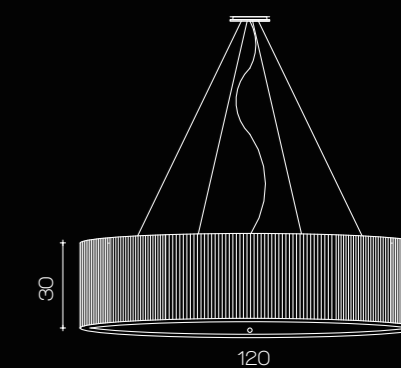

Art.1513/4



250



Art. 1161
 Pø 30 cm H 70 cm
 1 x E27 x 60W



Art. 1169
 Pø 30 cm H 65 cm
 1 x E27 x 60W

251



Art. 1227/S
 Pø 35 cm H 40 cm
 1 x E27 x 60W



Art. 1091/KR
Pø 22 cm H 48 cm
1 x E14 x 40W

Art. 1092/KR
Pø 30 cm H 68 cm
1 x E14 x 60W



Art. 1091/OVAM
Pø 22 cm H 48 cm
1 x E14 x 40W

Art. 1092/OVAM
Pø 30 cm H 68 cm
1 x E14 x 60W



Art. 1164 KR
Pø 50 cm H 175 cm
1 x E27 x 60W



Art. 1214/SO
 P lato 18 cm ø max 78 cm
 H max 90 cm - min 75 cm
 4 x E27 x 60W



Art. 1214
 P lato 32 cm H 70 cm
 1 x E27 x 60W

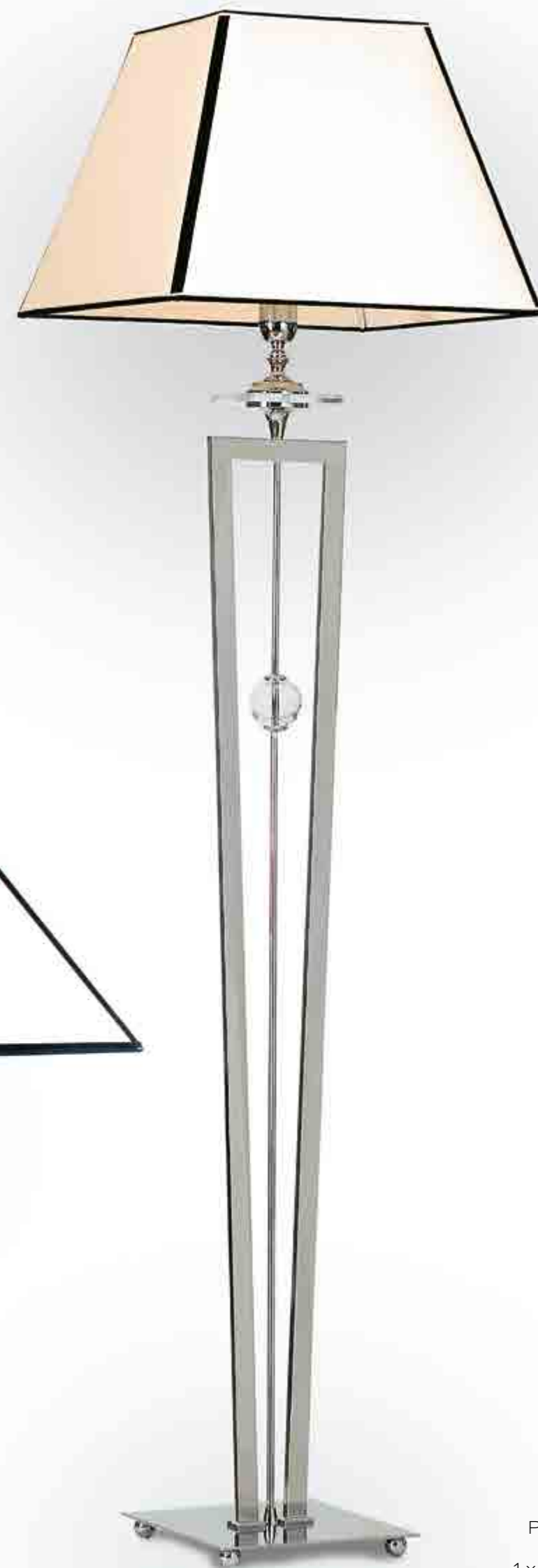

Art. 1214/FL
 P lato 40 cm
 H 180 cm
 1 x E27 x 60W



Art. 1368/CH6/KR
 ø 95 cm H 60 cm
 Pø 16 cm
 6 x E14 x 40W



Art. 2032/CH14/NL
 L 150 x 57 cm H 87 cm
 14 x E14 x 40W

Art.1425/A
H 44 cm PL 44 cm Sp 18 cm
1 x E27 x 60W



Art. 1425/CH
PL 53 cm
2 x E27 x 60W H 47 cm



*Serie in tubo di ottone cromo
quadro, paralume quadro
tessuto Dedar stampa
coccodrillo avorio chiaro*

Art.1425/FL
PL 53 cm H 180 cm
2 x E27 x 60W

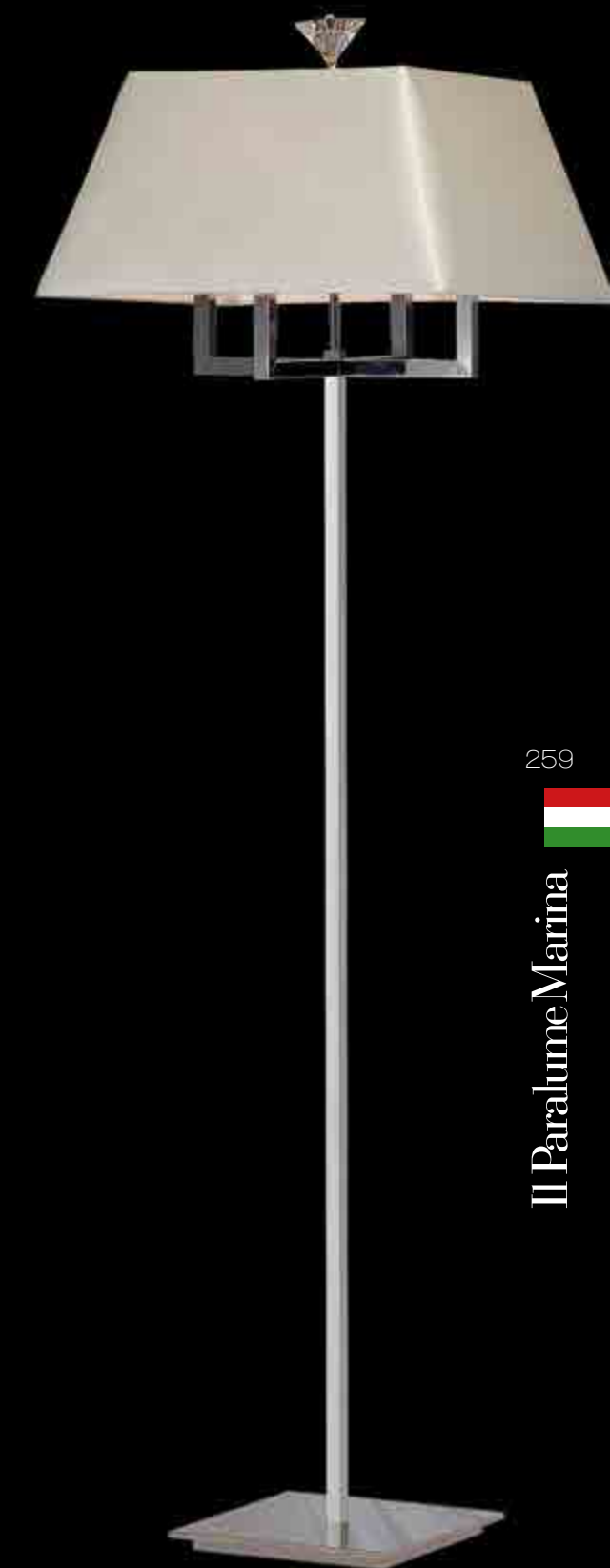

259



Il Paralume Marina



Art. 1425/G
PL 36 cm H 50 cm
1 x E14 x 40W



Art. 1425/P
PL 23 cm H 43 cm
1 x E14 x 40W



Art. 1425 Port.
L 30 cm H 47 cm



*Lampadario con tubo diamantato
cromo, foglie in plexiglass e inserti
Swarovski, paralume rigido in seta
chiara senza bordo.*

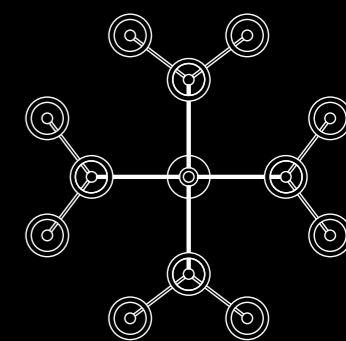

Art. 1446
Ø 120 cm H 87 cm
PØ 16 cm
12 x E14 x 40W

263



Il Paralume Marina



Art. 1762/CH12
Ø 106 cm H 64 cm
PØ 16 cm
12 x E14 x 40W



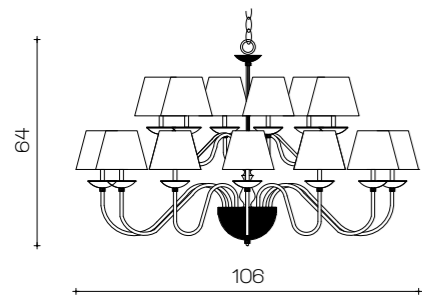

Art. 1447/CH18
 ø 106 cm H 64 cm
 Pø 16 cm
 18 x E14 x 40W

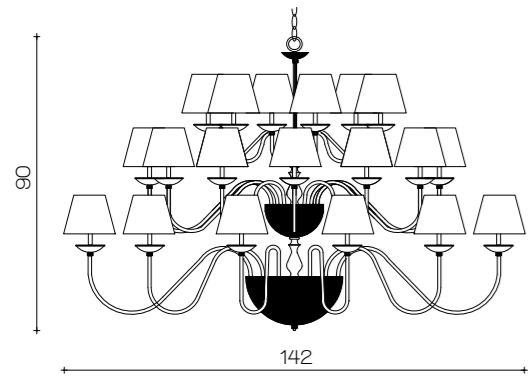

Art. 1447/CH30
 ø 142 cm H 90 cm
 Pø 16 cm
 30 x E14 x 40W

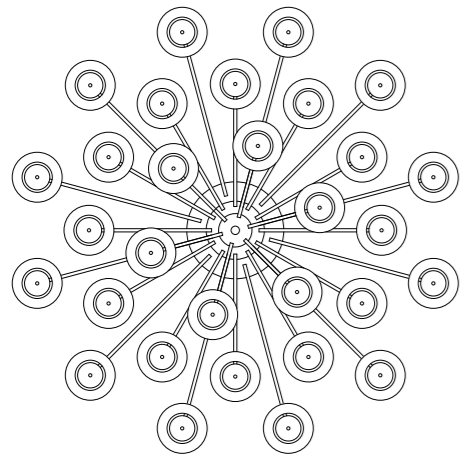

Art. 1447/A2
 L 61 cm H 40 cm
 Pø 16 cm
 2 x E14 x 40W



Art. 1570/P
 Pø 25 cm H 60 cm
 1 x E14 x 40W



Art. 1447/CH6
 ø 74 cm H 38 cm Pø 16 cm
 6 x E14 x 40W

Lampadario in ottone cromato e inserti Swarovski, paralume in seta pura e passamaneria in Swarovski.

Chandelier in chrome brass with Swarovski inserts, lampshade in white crumple silk with a Swarovski braid.

Люстра из хромированной латуни и с насадками из Swarovski, абажур из шелковой ткани натёртой до белого цвета и отделочными материалами из Swarovski.



Piantana e lampade con base
in fusione di ottone cromato
e inserti Swarovski, paralume
chiffon, fodera in avorio chiaro
e passamaneria con piume.

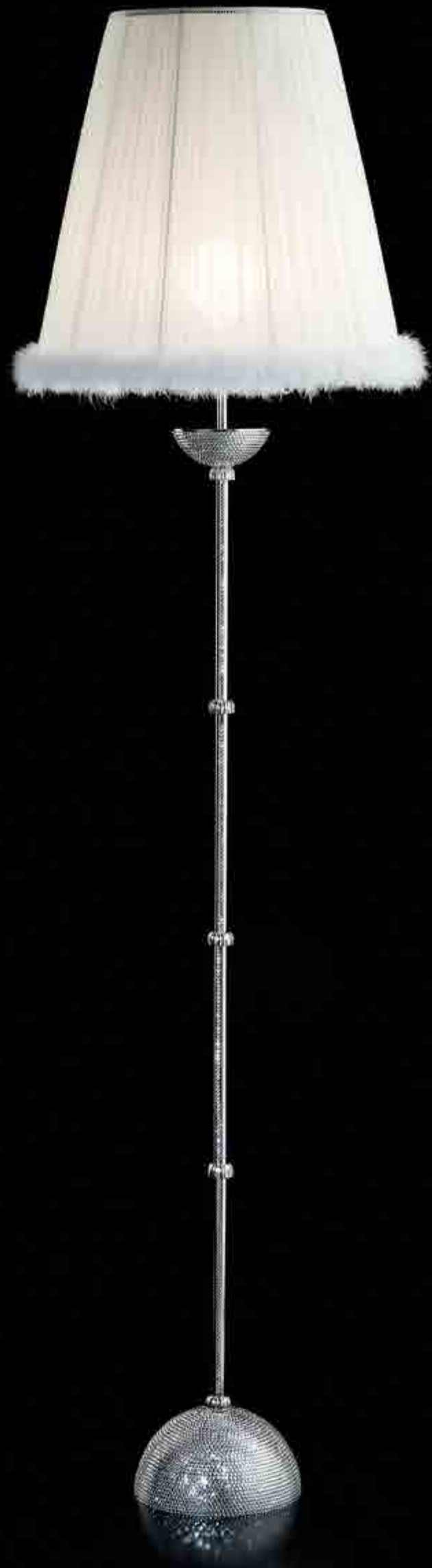

Art. 1447/FL
Pø 45 cm H 180 cm
1 x E27 x 60W



Art. 1448/P
H 34 cm

Art. 1448/G
H 39 cm

Art. 1447/P
Pø 18 cm H 60 cm
1 x E14 x 40W

Art. 1447/G
Pø 21 cm H 65 cm
1 x E14 x 40W





270

Lampadario con inserti Swarovski, paralume in seta a righe argento.

Art. 1457/CH5
ø 72 cm H 70 cm Pø 16 cm
5 x E14 x 40W

Lampada con inserti Swarovski, paralume in seta pura bianca lucida a pieghe piatte.



271

Art. 1456/G
Pø 35 cm H 60 cm
1 x E27 x 60W

Art. 1456/P
Pø 18 cm H 40 cm
1 x E14 x 40W

Il Paralume Marina 



Art. 1412
Pø 40 cm H 175 cm
1 x E27 x 60W



Art. 1411
Pø 25 cm H 65 cm
1 x E27 x 60W



*Lampada in cristallo fiorentino
molato a mano, paralume in
tessuto a pois argento.*

Art. 1566/KR
P ovale 40x27 H 83 cm
1 x E27 x 60W
Nappa N. 14





Paralume in seta avorio
a pieghe piatte.

Art. 1428
ø 18 cm H 28 cm
1 x E14 x 40W



Art. 1502/G
Pø 35 cm H 70 cm
1 x E27 x 40W

Art. 1502/P
ø 25 cm H 45 cm
1 x E14 x 40W



Serie in ottone oro
vecchio con inserti in cristallo,
paralume in seta pura con
righine oro arriciata.

Art. 1502/CH5
ø 72 cm H 70 cm Pø 16 cm
5 x E14 x 40W

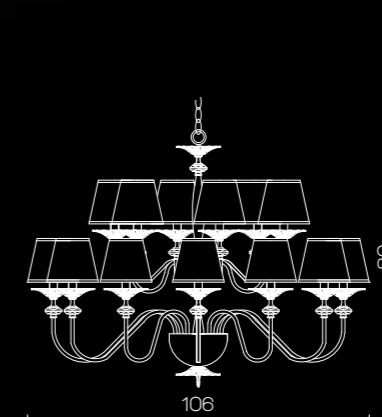

Art. 1502/CH18
ø 106 cm H 80 cm Pø 16 cm
18 x E14 x 40W

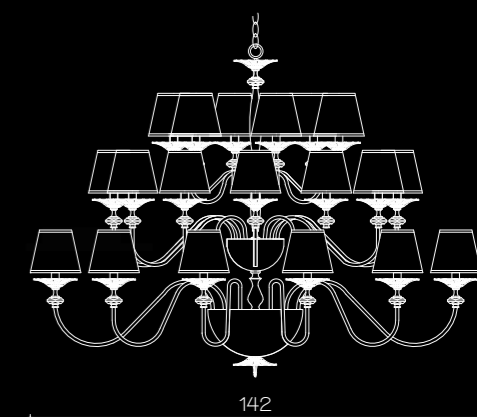

Art. 1502/CH30
ø 142 cm H 105 cm Pø 16 cm
30 x E14 x 40W





Art.1329/P
ø 16 cm H 42 cm
1 x E14 x 40W

Art.1329/G
ø 20 cm H 63 cm
1 x E27 x 40W



Art. 1329/A1
Pø 20 cm H 70 cm
Sporgenza max 28 cm
1 x E27 x 40W



Art. 1321/A
ø 20 cm H 40 cm
1 x E14 x 40W



Art. 2095/NL
L 30 cm H 71 cm Sp max 10 cm
1 x E27 x Led 10W



Art. 2096/BI
L 10 cm H 60 cm Sp 6 cm
2 x G9 x Led 10W

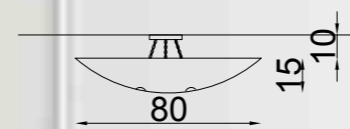

Art. 2101/G/LU
Ø 80 cm H 15 cm
H tot 25 cm
4 x E27 x Led 7W

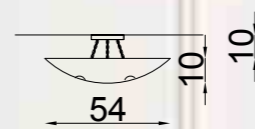

Art. 2101/P/LU
Ø 54 cm H 10 cm
H tot 20 cm
2 x E27 x Led 7W



Art. 2097/BI
L 18 cm H 55 cm Sp 10 cm
2 x E14 x Led 5W



Art. 2092/LU
Pø 35 cm H 78 cm
1 x E27 x 60W



Art. 2091/LU
Pø 35 cm H 78 cm
1 x E27 x 60W



Art. 2090/NN
Pø 35 cm H 78 cm
1 x E27 x 60W



Art 1952/LU /AM
P ø 30 cm H 77 cm
1 x E27 x 60W

Art 1952/NL/GR
P ø 30 cm H 77 cm
1 x E27 x 60W

Art 1952/NL/BI
P ø 30 cm H 77 cm
1 x E27 x 60W



Art 1943/NN/AM
P ø 35 cm H 66 cm
1 x E27 x 60W

Art 1944/NN/GR
P ø 35 cm H 66 cm
1 x E27 x 60W





Art 1950/BI
P ø 40 cm H 74 cm
1 x E27 x 60W
RAL9016



Art 1945/BI
P ø 48 cm H 74 cm
1 x E27 x 60W
RAL9016

Art 1945/NN
P ø 48 cm H 74 cm
1 x E27 x 60W





Art. 1951/LU/RO
 Pø 38 cm H 98 cm
 1 x E27 x 60W
 Nappa N.47



Art. 1951/LU/TR
 Pø 38 cm H 98 cm
 1 x E27 x 60W



Art. 1030
P quadro ø 35 cm H 75 cm
1 x E27 x 60W



Art.1717/G
P Lato 45 x 45 cm H 98 cm
1 x E27 x 60W

Art.1717/P
Pø 40 cm H 71 cm
1 x E27 x 60W

Art. 1344
Pø 40 cm H 70 cm
1 x E27 x 60W



Tessuti ricoperti di Swarovski
Lampada da cristallo italiano

290

Art. 1338
Pø 30 cm H 76 cm
1 x E27 x 60W



291





Art. 1830/KR/BI
Pø 50 cm H 144 cm
2 x E27 x 60W
nappa n.43



Art. 1830/KR/NR
Pø 50 cm H 144 cm
3x E27 x 60W
nappa n.43



Portafiori
Art. 1831/NR
ø 34 cm H 67 cm

Portafrutta
Art. 1832/NR
ø 43 cm H 33 cm

Porta Caramelle
Art. 1833/NR
ø 19 cm H 26 cm





Il Paralume Marina
Classic Lighting



Art.1914/CH12/AV
103 cm H 61 cm
12 x E14 x 40W



Il Paralume Marina
Classic Lighting

Art.1914/A2/AV
ø 41 cm H 38 cm
2 x E14 x 40W





2



4



6



8



10



12



14



16



18



20



22



24



26



28



30



32



34



36



38



40



42



44



46



48



50



52



54



56



58



60



62



64



66



68



70



72



74



76



78



80



82



84



86



88



90



92



94



96



98



100



102



104



106



108



110



112



114



116



118



120



122



124



126



128

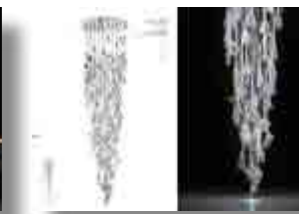

130



132



134

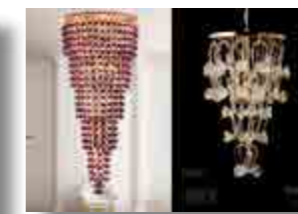

136



138



140



142 144 146 148 150



152 154 156 158 160



162 164 166 168 170



172 174 176 178 180



182 184 186 188 190



192 194 196 198 200



202 204 206 208 210



212 214 216 218 220



222 224 226 228 230



232 234 236 238 240



242 244 246 248 250



252 254 256 258 260



262 264 266 268 270



272 274 276 278 280



282



284



286



288



290



292



Art. 1953/NL/RS
Pø 40 cm H 120 cm
1 x E27 x 60W
Nappa N.49

Art. 1953/NL/AZ
Pø 40 cm H 120 cm
1 x E27 x 60W
Nappa N.44 Argento

Art. 1953/NL/TR
Pø 40 cm H 120 cm
1 x E27 x 60W
Nappa N.45 Argento



Art. 1953/LU/VI
Pø 40 cm H 120 cm
1 x E27 x 60W
Nappa N.46

300

301



Il Paralume Marina

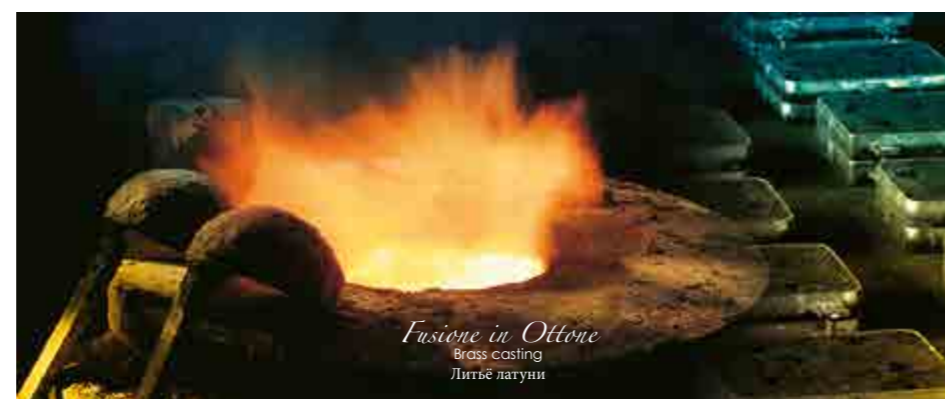

• La Passione, la dedizione e la cura attentissima del dettaglio, animano l'atelier della Signora Marina. Moderne tecnologie affiancano lavorazioni manuali tradizionali x ottenere un prodotto totalmente esclusivo e di eccellenza, 100% Made in Italy . La continua ricerca e innovazione di tessuti e passamanerie rende Il Paralume Marina Leader nel creare oggetti su misura.

• *Passion, dedication and careful attention to detail bring to life the workshop of Mrs. Marina. Modern technologies alongside traditional manual processes obtain a product totally unique and of high quality, 100% Made in Italy. The continuous research and innovation of fabrics and trimmings makes Il Paraluma Marina, the Leader in creating custom-made products.*

• В ателье госпожи Марины царят Вдохновение, Страсть, Самоотдача и высочайшее Внимание к деталям. Современные технологии идут рука об руку с традиционными техниками рукоделия, воплощаясь в эксклюзивном продукте, 100% сделанном в Италии. Постоянные исследования и применения последних инноваций в тканях и окантовках делают Il Paralume Marina лидером среди производителей персонализированных изделий.

• La fusione in terra dell'ottone è un'arte antica, che ancora oggi sa emozionare. La pressofusione crea oggetti di eccellenza e di altissima qualità sinonimi di lusso ed eleganza esclusivamente made in Italy. Fondiamo metallo trasformando l'idea di architetti e designer in oggetti esclusivi, dal prototipo allo stampo, al prodotto finito.

• *Brass sand casting is an ancient art, which still continues to excite. Casting creates objects of excellence and of the highest quality, demonstrating luxury and elegance exclusively made in Italy. We base metal transformation on the ideas of exclusive product architects and designers, from the prototype, to the mould, to the finished product.*

• Литье латуни «в землю» - это античное искусство, которое и сегодня способно вызывать эмоции. Литье создает предметы высокого качества с особым благородным шармом, присущим роскошным интерьерам, сделанным исключительно в Италии. Мы плавим металл, трансформируя идею архитектора и дизайнера в эксклюзивные предметы: от прототипа – к штампу – до законченного продукта

• Maestri artigiani che tramandano l'arte antica muranese garantiscono un prodotto di classe di alta gamma e qualità indiscutibili. La produzione interamente artigianale e l'uso di tecniche raffinate rendono ogni oggetto un pezzo unico. L'esperienza dei maestri per noi è un punto di partenza per creare oggetti attuali di arredamento e di emozione. La forza del Paralume Marina è la qualità eccellente e la flessibilità nell'assecondare le richieste di un mercato internazionale sempre in evoluzione.

• *Master craftsmen who hand down the ancient art of Murano guarantee a high-class product of unquestionable quality. Total handmade production and the use of sophisticated techniques make each product unique. The experience of the master craftsmen is a starting point for us to create real pieces of furniture of emotion. The strength of Il Paraluma Marina is the excellent quality and flexibility to adapt to the demands of an ever changing market.*

• Мастера-ремесленники передают античное искусство муранского стекла из поколения в поколение, что гарантирует их изделиям высочайший уровень качества. Изготовление вручную и использование искусных техник делают каждое их творение уникальным и неповторимым. Опыт Мастеров является для нас отправной точкой для создания актуальных предметов интерьера с ярким эмоциональным оттенком. Сильной стороной Il Paralume Marina является безупречное качество и гибкость в подходе к требованиям динамичного и такого разнообразного международного рынка.

• Il cristallo è orgogliosamente solo italiano. Si ottiene fondendo in appositi forni a temperatura elevata, superiore a 1400°, utilizzando materie prime di qualità superiore si ottiene un prodotto con oltre il 24% di PbO, che conferisce una luminosità e trasparenza indiscutibili. La lavorazione del cristallo è eseguita artigianalmente; viene soffiato a bocca e le incisioni sono eseguite interamente a mano per cui ogni oggetto diviene "Oggetto d'Arte".

• *Paraluma Marina proudly uses only Italian crystal. It is made by melting in special high temperature furnaces, exceeding 1400°, using optimum quality raw materials a product is obtained with over 24% of PbO, which gives an undeniable brightness and clarity. The processing of crystal is carried out by hand; it is blown and the incisions are made entirely by hand so that every object becomes an "Objet d'art".*

• Исключительно лучший итальянский хрусталь является нашей гордостью и отличительной чертой. Его получают посредством плавки в специальных печах при высокой температуре, превышающей 1400°, используя материалы лучшего качества. Это позволяет получить продукт с процентом свинца в составе в 24% и выше, что придает изделиям безупречную прозрачность и яркость. Обработка хрусталя проходит вручную: его выдувают, а затем гравировать полностью вручную, что гарантирует каждому изделию титул Произведения Искусства.

Il Paralume Marina

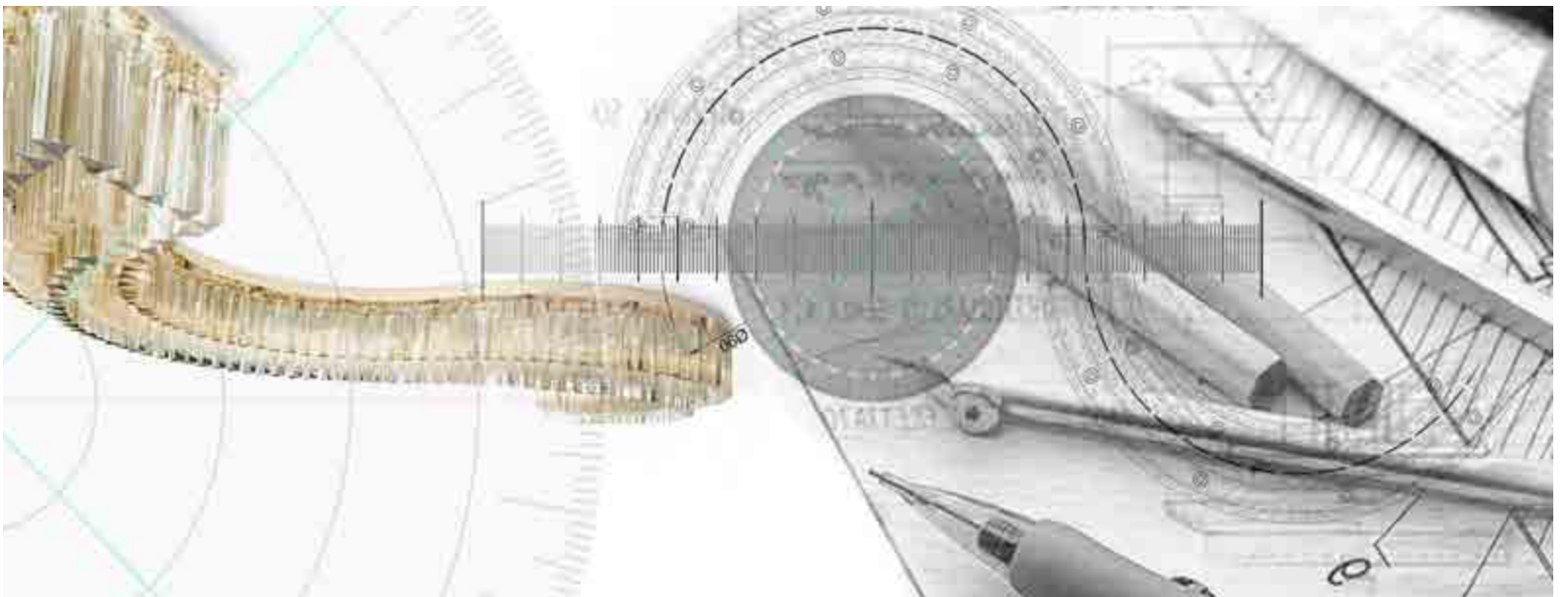

Ogni progetto è una sfida che affrontiamo con serietà e passione, dedizione al cliente e cura nei dettagli maniacale. Il Paralume Marina con la sua esperienza e con il suo team interno di designer e ingegneri, garantisce un servizio esclusivo ai professionisti che desiderano utilizzare soluzioni di illuminazione decorativa nei loro progetti, proponendo alternative stilistiche, tecniche ed economiche adeguate alla richieste della committenza.

Each project is a challenge that we approach with seriousness and passion, dedication to the customer and meticulous attention to detail. Il Paraluma Marina with its experience and in-house team of designers and engineers, guarantees an exclusive service for users who wish to use decorative lighting solutions in their projects, offering stylistic, technical and inexpensive options adapted to the demand of the client.

Каждый проект – это вызов, который мы принимаем с максимальной серьезностью и страстью, преданностью клиенту и маниакальным вниманием к деталям. Il Paralume Marina со своим опытом и собственной сплоченной командой дизайнеров и инженеров, гарантирует эксклюзивный сервис для профессионалов, которые желают включить в собственные проекты смелые решения по декоративному освещению, предлагая стилистические, технические и экономические альтернативы, оптимально адаптированные под запрос Заказчика.

Il Paralume Marina

Made in Italy
since 1987



www.ilparalumemarina.it