



CLASSIC 2019

**Il Paralume Marina**

# Il Paralume Marina

Classic Lighting

## *About us*

La storia dell'azienda IL PARALUME MARINA nasce nel 1987 quando i coniugi Ferronato-Simoncello hanno fondato la loro piccola azienda familiare basata sulla comune passione per l'illuminazione decorativa. Negli anni seguire i figli Thomas e Simone hanno dato ulteriore impulso rispettivamente all'internazionalizzazione commerciale del prodotto in tutto il mondo ed ad un alto livello tecnico-progettuale degli stessi corpi illuminanti. Negli anni a seguire il loro lavoro ha elevato il marchio PARALUME MARINA ad un firma internazionale e questo brand è diventato sinonimo di dedizione e creatività combinate ad un eccellente grado di qualità artigianale esclusivamente Made in Italy. La produzione è basata su antiche tecniche di fusione dell'ottone, dal cristallo italiano, dalla soffiatura del vetro di Murano e dallo stile unico dei paralumi cuciti a mano dall'atelier della signora Marina. Il cristallo autentico Swarovski completa la scintillante brillantezza di questi pezzi unici. Ogni creazione è fatta a mano secondo le esigenze del cliente. Il Paralume Marina è specializzato nella produzione di pezzi su misura secondo i desideri del cliente e offre un ampio raggio di tessuti, passamanerie, finiture di ottone e di colori di vetro e cristallo da cui attingere. Questo dà l'opportunità al cliente di scegliere qualcosa di unico ed irripetibile creato esclusivamente da lui e per lui. Gli architetti e i designers de IL PARALUME MARINA sono disponibili a creare la giusta collezione per ogni interior a cominciare dai lampadari, a proseguire con spot ad incasso, bastoni tenda e accessori da bagno. Siamo orgogliosi di poter soddisfare qualsiasi richiesta sia per gli interni di case private sia per prestigiosi hotel. Potete ammirare i nostri progetti di illuminazione in tutto il mondo.

*The story of the company IL PARALUME MARINA has started in 1987 when the spouses Ferronato-Simoncello have founded their small family-run business based on the common passion for decorative ITALIAN lighting. In the followings years their sons Thomas and Simone have given further drive, respectively in internationally marketing the products all over the world and at high technical design levels of lights themselves. In 30 successful years their hard work have brought "Il Paralume Marina" an international fame and this brand has become a representation of commitment and creativity combined with high Made in Italy craftsmanship quality. Its production is based on the antique techniques of brass fusion, blowing of the Murano glass and Italian Crystal and unique recognizable style of the handsewn lampshades from Mrs. Marina. The authentic Swarovski crystals complement the sparkling beauty of the manufactures. Every item is created by hand and with consideration of every client's wish. IL PARALUME MARINA is specialized in producing of customized articles and always offers the wide range of various fabrics, trimmings, tassels, brass, crystal and glass colours to choose from. This way we give the Client opportunity to create every time something special and unrepeatable, something that He can call His own, made exclusively for Him. The architects and designers of Il Paralume Marina are ready to create the whole collection for any ambience starting with chandeliers and finishing with spotlights, bathroom accessories and curtain rods. We are able to satisfy any request, whether it is a private house or a luxury hotel. In fact on the list of projects completed there are numerous top-rate hotels and residences, villas and castles throughout the world.*

История компании IL PARALUME MARINA началась в 1987 году, когда супруги Ферронато-Симончелло основали свой маленький семейный бизнес, движимые общей любовью к декоративному освещению. Годы спустя их традицию не только продолжили, но и развили сыновья Томас и Симоне, каждый из которых внес свой вклад в развитие компании как в международном маркетинге, так и в высокотехнологичном дизайне светильников. 30 лет тяжелой, но успешной работы принесли IL PARALUME MARINA международную славу и сегодня этот бренд ассоциируется с креативностью и самоотдачей, обремененной с высочайшим качеством продукта, сделанного в Италии. Производство основано на старинных технологиях литья латуни, выдувания муранского стекла и флорентийского хрусталя и, конечно же, на уникальном и узнаваемом стиле шитых вручную абажуров от г-жи Марины. Сияющую красоту изделий дополняют подлинными кристаллы Swarovski. Каждое изделие создано строго вручную, с учетом всех пожеланий заказчика.

IL PARALUME MARINA специализируется на производстве персонализированных изделий и всегда предлагает широкий спектр тканей, кантов, кистей, большой выбор отделок металла, хрусталя и муранского стекла. Это позволяет Заказчику каждый раз создавать что-нибудь особенное и неповторимое, что он может назвать Своим, сделанным специально для Него. Архитекторы и дизайнеры IL PARALUME MARINA готовы создать полную коллекцию для любого помещения, начиная от люстр и заканчивая встроенными светильниками, аксессуарами для ванных комнат, а также карнизами. Мы способны удовлетворить любой запрос, будь-то частный дом или роскошный отель, о чем свидетельствуют снимки завершенных проектов, среди которых топ-рейтинговые гостиницы и резиденции, виллы и замки по всему миру.

*Made in Italy*

Since 1987



*Il Paralume Marina non produce ma crea. Design ed innovazione, ricerca e sviluppo incontrano tecniche lavorative di grandi maestri artigiani. La fusione d' Ottone in terra, il Cristallo Italiano, il vetro di Murano, i Tessuti di Sete e di Organze, coronati da Swarovski Elements non ti faranno avere nessun compromesso.*

*Il Paralume Marina not simply produces but creates. Design and innovation, research and development meet working techniques of the greatest Italian craftsmen. Fusion of brass, Italian crystal, Murano glass, silk and organza fabrics, decorated with Swarovski Elements.*

*Il Paralume Marina не производит, а творит. Дизайн и инновации, исследования и разработка идут рука об руку с техниками великих мастеров-ремесленников. Литьё латуни «в землю», итальянских хрусталь, муранское стекло, ткани из шелка и органзы, украшенные кристаллами Swarovski Elements, не оставляют компромиссов.*



Art. 1967/CH58/LU  
Ø 215 cm H 225 cm  
58 x E14 x 40W





Art. 2150/CH18  
ø 142 cm H 95 cm  
18 x E14 x 40W

*Chandelier made with polished gold fusion brass and castle of transparent and frosted Murano's Glass. Symbol of handcraft excellence and refinement of materials, design and classic creating a bright masterpiece effect.*

Art. 2150/FL  
ø 65 cm H 180 cm  
5 x E14 x 40W



Art. 1967/CH22/LU  
ø 122 cm H 94 cm  
22 x E14 x 40W







6

Art. 2149/CH48  
ø 197 cm H 225 cm Kg 140  
48 x E14 x 40W +9 x E14 x 40W

Art. 1956/CH18/LU  
ø 142 cm H 94 cm  
18 x E14 x 40W



7

Il Paralume Marina



Art. 1956/CH30/LU  
∅ 136 H 180 cm  
30 x E14 x 40W



Art. 1956/CH6/LU  
∅ 92 cm H 64 cm  
6 x E14 x 40W



Art. 1956/A2/LU  
L 38 cm H 59 cm Sp 21 cm  
2 x E14 x 40W



Art. 1953/LU/VI  
Pø 40 cm H 120 cm  
1 x E27 x 60W  
Nappa N.46



Art. 1953/NL/RS  
Pø 40 cm H 120 cm  
1 x E27 x 60W  
Nappa N.49

Art. 1953/NL/AZ  
Pø 40 cm H 120 cm  
1 x E27 x 60W  
Nappa N.44 Argento

Art. 1953/NL/TR  
Pø 40 cm H 120 cm  
1 x E27 x 60W  
Nappa N.45 Argento





Art. 1953/LU/AM  
Pø 40 cm H 120 cm  
1 x E27 x 60W  
Nappa N.44 Oro

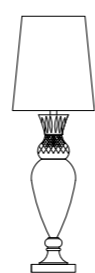

Art. 1953/P  
Pø 26 cm H 82 cm  
1 x E27 x 40W



Art. 1759/CH12/New Bis  
ø 103 cm H 90 cm Pø 14 cm  
12 x E14 x 25W





Art. 1759/FL/New Bis  
ø 58 cm H 190 cm Pø 14 cm  
6 x E14 x 25W



Art. 1759/Flambeaux/New Bis  
ø 65 cm H 95 cm Pø 14 cm  
5 x E14 x 25W

Art. 1759/A3/New Bis  
ø 40 cm H 55 cm Pø 14 cm  
3 x E14 x 25W



*E' un esempio del design e del lusso equilibrato e non convenzionale de IL PARALUME MARINA. Create con cura e devozione, le opere sono realizzate interamente a mano e nella loro singolarità racchiudono frammenti di anima e di poesia.*

*It is a perfect example of balanced and unconventional union of design and luxury of IL PARALUME MARINA. Created with great care and devotion these little masterpieces are made entirely by hand and their uniqueness is in a perfect match of the main components - fragments of soul and poetry.*

*Вот отличный пример союза дизайна с умеренной и нетрадиционной роскошью IL PARALUME MARINA. Изделия производятся полностью вручную, с заботой и преданностью их создатели вкладывают в каждое творение часть своей души.*

Art. 1744/FL/ORO24K  
ø 50 cm H 185 cm Pø 16 cm  
5 x E14 x 40W



Art. 1744/CH16/ORO24K  
H 160 cm ø 120 cm Pø 16 cm  
16 x E14 x 40W



16

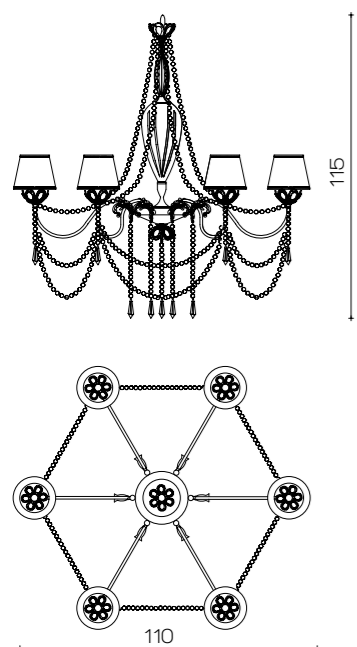

Art. 1744/CH6/ORO24K  
ø 110 cm H 115 cm Pø 16 cm  
6 x E14 x 40W

17

Paralume Marina





Art. 1744/A1/ORO24K  
 H 50 cm Pø 16 cm  
 Sp 25 cm  
 1 x E14 x 40W

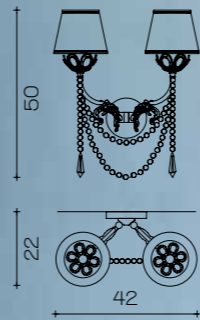

Art. 1744/A2/ORO24K  
 ø 42 cm H 50 cm  
 Pø 16 cm Sp 22 cm  
 2 x E14 x 40W

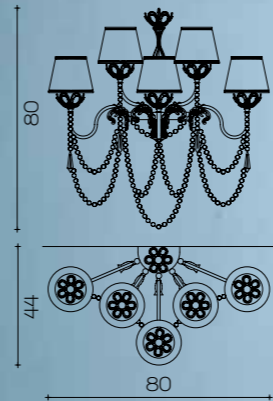

Art. 1744/A5/V2/ORO24K  
 ø 80 cm H 80 cm  
 Pø 16 cm Sp 44 cm  
 5 x E14 x 40W



Art. 1744/A5/V1/ORO24K  
 ø 60 cm H 80 cm  
 Sp 44 cm Pø 16 cm  
 5 x E14 x 40W





Art. 1744/A5/ORO24K  
 ø 60 cm H 80 cm  
 Sp 44 cm Pø 16 cm  
 5 x E14 x 40W

*La base è in fusione di ottone massiccio in finitura oro 24, le bobeches sono decorate con petali ed inserti in cristallo Swarovski Elements, mentre il fusto trasparente è di cristallo fiorentino molato mano, una combinazione di glamour e di classico, di tradizione e modernità.*

*The combination of glamour and classic, tradition and modernity: the base is made by fusion of the brass in 24 carat gold cover, the bobeches are decorated with petals and Swarovski Elements inserts while the stock is clear Florentine crystal grinded by hand.*

*Основa выполнена из латуни под золото 24 карата, bobeches украшены лепестками и Swarovski Elements, в то время как центральная часть сделана из прозрачного флорентийского хрусталя, гравированного вручную. Сочетание гламура и классики, традиции и современности.*

Art. 1744/G/ORO24K  
 ø 50 cm H 110 cm Pø 16 cm  
 5 x E14 x 40W





22

*Give you a jewel*



23

Il Paralume Marina

Art. 1622  
ø 50 cm H 90 cm Pø 16 cm  
5 x E14 x 40W





24

Art. 2045/A2/LU  
L 34 cm H 58 cm  
2 x E14 x 40W



25

Il Paralume Marina

Art. 2045/CH12/LU  
ø 110 cm H 108 cm  
12 x E14 x 40W  
+3 x E14 x Led 5W





Art. 2058/A2/LU  
L 35 cm H 42 cm Sp 21 cm  
2 x E14 x 40W

Art. 2058/A3/LU  
L 42 cm H 55 cm Sp 27 cm  
3 x E14 x 40W



Art. 2070/A2/LU  
L 28 cm H 29 cm Sp 12 cm  
2 x E14 x 40W

Art. 2070/A3/LU  
L 33 cm H 42 cm Sp 18 cm  
3 x E14 x 40W



Art. 2100/CH6  
L 95 x 84 cm H 115 cm Pø 18 cm  
Ceiling base 30 x 8 x 8 cm  
6 x E14 x 40W  
Pannello Led 3000K  
Lumen 4649 36W



Art. 2100/TABLE/G  
L 105 x 58 cm H 46 cm  
Coffee table in Casting Brass  
and Italian crystals elements.

Art. 2100/CH4  
L 59 x 60 cm Pø 18 cm  
Ceiling base 30 x 8 x 8 cm  
4 x E14 x 40W  
+ Pannello Led 3000K  
Lumen 2066 16W





Art. 2099/LU  
L 94 x 48 cm H 7 cm  
+ 50 cm steel cable  
Ceiling base 30 x 8 x 8 cm  
Pannello Led 3000K  
Lumen 4649 36W



30

Art. 2100/POUFF/G  
L 105 x 58 cm  
H 59 cm

Puff in eco-leather  
and Swarovski crystals,  
structure in casting brass  
and Italian crystals elements.



Art. 2100/A  
Pø 18 cm H 57 cm  
Sp 22 cm  
1 x E14 x 40W



Art. 2100/T  
Pø 35 cm H 78 cm  
1 x E27 x 60W

31

Il Paralume Marina





32

Art. 2066/CH12/LU  
ø 82 cm H 86 cm  
Pø 13 cm  
12 x E14 x 40W



33

Art. 2066/T/LU  
P oval 50 x 30 cm H 78 cm  
2 x E14 x 40W





34

Art. 2066/A2/LU  
L 32 cm H 60 cm  
Pø 13 cm Sp 18 cm  
2 x E14 x 40W



Art. 2066/C/LU  
ø 39 cm H 87 cm  
candles not included



35

Art. 2066/CH8/LU  
ø 60 cm H 70 cm Pø 13 cm  
8 x E14 x 40W





Art. 2067/T/LU  
 Pø 40 cm H 76 cm  
 3 x E14 x 40W



Art. 2061/FL/LU  
 Pø 50 cm H 164 cm  
 1 x E27 x 60W



Art. 2068/T/LU  
 Pø 40 cm H 72 cm  
 1 x E27 x 60W





*Collection of lighting objects in cast brass  
and Florentine crystal cut by hand.*

Art. 1914/CH6/AV  
Ø 83 cm H 41 cm  
6 x E14 x 40W



Art. 1904  
PØ 40 cm H 87 cm  
1 x E27 x 60W





40



Art. 1914/CH12/AV  
Ø 103 cm H 61 cm  
12 x E14 x 40W



41



Il Parlume Marina

Art. 1914/A2/AV  
Ø 41 cm H 38 cm  
2 x E14 x 40W





Art. 1853/A2/OV  
L 60 cm H 42 cm  
Sp 38 cm Pø 22 cm  
2 x E14 x 40W



Art. 1853/FL/OV  
ø 54 cm H 180 cm  
3 x E27 x 40W



Art. 1853/CH5/OV  
ø 80 cm H 43 cm Pø 22 cm  
5 x E14 x 40W





Art. 1853/FLAMBEUX/OV  
ø 50 cm H 92 cm Pø 22 cm  
3 x E14 x 40W



Art. 1853/CH10/OV  
ø 102 cm H 67 cm Pø 22 cm  
10 x E14 x 40W





*Serie in fusione di ottone, bocce di Murano  
trasparenti e oro con pendenti Swarovski,  
paralume in chiffon bordeaux su fodera gialla.*







Art. 931/L5  
H 45 cm ø max 75 cm  
Pø 16 cm  
5 x E14 x 40W



Art. 931/P  
Pø 25 cm H 48 cm  
1 x E14 x 40W





Art. 931/flambeaux  
 ø max 46 cm H 71 cm  
 Pø 14 cm  
 5 x E14 x 40W



Art. 974  
 ø max 38 cm H 30 cm  
 Pø 14 cm  
 2 x E14 x 40W



Art. 931/B3  
 Pø 55 cm H 185 cm  
 3 x E14 x 40W





Art. 1629/CH20/AV  
ø 132 Pø 16 cm H 100 cm  
20 x E14 x 40W



Art. 936/BIS  
ø 50 cm  
H 78 cm  
1 x E27 x 60W

Art. 1629/CH10/AV  
ø 116 cm H 70 cm  
10 x E14 x 40W





54

Art. 1986/CH6  
 ø 68 cm H 61 cm  
 Pø 16 cm  
 6 x E14 x 40W

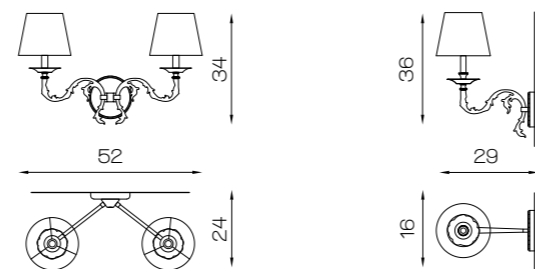

Art. 1986/A2  
 ø 52 cm H 34 cm  
 Pø 16 cm  
 2 x E14 x 40W

Art. 1986/A1  
 ø 16 cm H 36 cm  
 Pø 16 cm Sp 29 cm  
 1 x E14 x 40W



55

Il Paralume Marina

Art. 1985/CH6  
 ø 60 cm H 61 cm  
 6 x E14 x 40W



Art. 1941/A2/TR  
L 40 cm H 56 cm  
Sp 21 cm Pø 16 cm  
2 x E14 x 40W



56



Art. 1941/CH6/OV/TR  
ø 86 cm H 52 cm Pø 16 cm  
6 x E14 x 40W



57



Art. 1941/CH12/BR/TR  
ø 130 cm H 87 cm Pø 18 cm  
12 x E14 x 40W



Art. 2057/CH12/LU  
Ø 114 cm H 74 cm PØ 16 cm  
12 x E14 x 40W



58

Art. 2057/CH6  
Ø 96 cm H 62 cm PØ 16 cm  
6 x E14 x 40W



59

Il Paralume Marina

Art. 2057/A3/LU  
L 64 cm H 50 cm  
Sp 36 cm PØ 16 cm  
3 x E14 x 40W





60



61

Il Paratume Marina

Art. 1162/CH10  
ø 83 cm H 74 cm  
Pø 18 cm  
10 x E14 x 40W





Art. 1231/P  
Pø 35 cm H 58 cm  
2 x E14 x 40W

Art. 1231/G  
Pø 43 cm H 70 cm  
2 x E14 x 40W

Art. 1162/B  
P ovale 60 cm H 185 cm  
2 x E27 x 60W



*Paralumi in organza e foglia oro.*

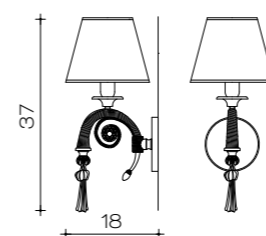

Art. 1162/A  
Pø 18 cm H 37 cm Sp 18 cm  
1 x E14 x 40W

Art. 1162/CH5  
ø max 60 cm H 60 cm Pø 18 cm  
5 x E14 x 40W





Art. 637  
Pø 16 cm H 70 cm  
ø max 60 cm  
5 x E14 x 40W



Art. TL28  
ø 55 cm  
H 175 cm  
3 x E27 x 40W



Art. 635/A  
L 45 cm H 50 cm  
Pø 11 cm  
2 x E14 x 40W



Art. 635  
ø 58 cm  
H 70 cm  
4 x E14 x 40W





66

Art. 1249/CH5  
ø max 52 cm H 70 cm  
Pø 16 cm  
5 x E14 x 40W



67

Il Paralume Marina

Art. 1249/A  
ø max 35 cm  
H 50 cm Pø 16 cm  
2 x E14 x 40W





Art. 1529  
L 50 cm H 70 cm  
Pø 16 cm  
2 x E14 x 40W



Art. 1529/FL  
L 70 cm H 175 cm  
2 x E14 x 40W



Art. 1529/A2  
L 50 cm H 44 cm  
Pø 16 cm  
2 x E14 x 40W



Art. 1529/CH8  
ø 90 cm H 75 cm Pø 18 cm  
8 x E14 x 40W



Lampadario dai colori tenui e morbidi, con elementi in fusione di ottone finito in oro vecchio e vetro colore seta di Murano, collane di perle di fiume e paralumi in chiffon avorio su fodera avorio delineati da una passamaneria in velluto beige coronati da fiocchetti in velluto.

Art. 1794/CH6  
H 76 cm Ø 106 cm PØ 16 cm  
6 x E14 x 40W

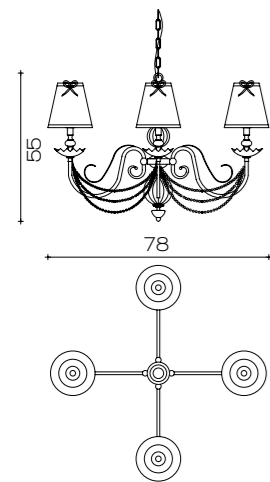

Art. 1794/CH4  
Ø 78 cm H 55 cm  
PØ 16 cm  
4 x E14 x 40W

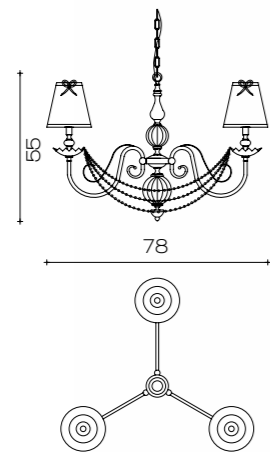

Art. 1794/CH3  
Ø 78 cm H 55 cm  
PØ 16 cm  
3 x E14 x 40W

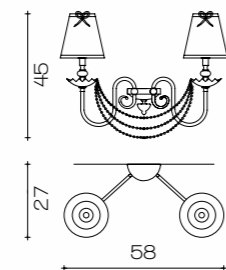

Art. 1794/A2  
L 58 cm H 45 cm  
Sp 27 cm PØ 16 cm  
2 x E14 x 40W

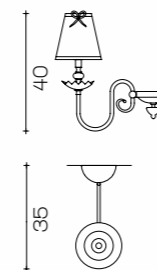

Art. 1794/A1  
H 40 cm Sp 35 cm  
PØ 16 cm  
1 x E14 x 40W

Chandelier by soft and smooth colours, elements made of fused brass finished in old gold colour and Murano glass of tender silk colour; necklaces of river pearls and lampshades in ivory chiffon on the ivory lining outlined by velvet trimming and crowned with velvet bows.

Люстра в мягких и нежных тонах с элементами из латуни под состаренное золото и муранского стекла цвета шёлка, ожерелья из речного жемчуга и абажуры из шиффона цвета слоновой кости на светлой подкладке, оборка и банты из бархата.



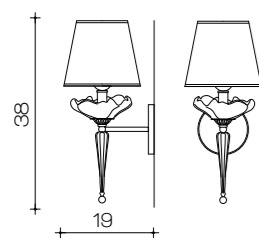

Art. 777/A  
 Pø 16 cm H 38 cm  
 Sp 19 cm  
 1 x E14 x 40W



Art. 791  
 H 175 cm  
 Pø 40 cm  
 1 x E27 x 60W



Art. 777/CH10  
 ø 92 cm H 75 Pø 16 cm  
 1 x E14 x 40W





Art. 777/CH5  
 ø 74 cm H 56 cm Pø 16 cm  
 5 x E14 x 40W



Art. 785  
 Pø 30 cm H 67 cm  
 1 x E27 x 40W

Art. 786  
 Pø 25 cm H 53 cm  
 1 x E14 x 40W





76

Art. 1879/FL/AV  
Pø 55 cm H 190 cm  
5 x E14 x 40W



77

Il Paratume Marina

Art. 1879/CH16/AV  
ø 106 cm H 100 cm Pø 18 cm  
16 x E14 x 40W





*Questa composizione frutto di alto artigianato italiano, e' emozionante nella cura dei dettagli della fusione di ottone in argento invecchiato e nei paralumi in chiffon avorio cuciti su una fodera di seta rosa. I pendenti di cristallo rosa Swarovski Elements donano un vivace ed elegante tocco contemporaneo. Full made in Italy.*

*This composition is a creation of high Italian craftsmanship. The attention to detail is impressive: silver-plated brass fusion, lampshades made of ivory chiffon sewn on the pink silk lining, pink crystal pendants by Swarovski Elements. all these components create an elegant and lively contemporary look.*

*Эта композиция - шедевр высокого итальянского мастерства. Вас впечатлит присущее ей внимание к деталям, начиная от покрытия латуни под серебро и абажуров из бежевого шиффона на розовой шёлковой подкладке и заканчивая розовыми подвесками Swarovski Elements, придающими всей коллекции элегантный современный вид. Full made in Italy.*

Art. 1689/FL/AV  
Pø 57 cm H 190 cm  
5 x E14 x 40W



Art. 1689/CH16/AV/RS  
ø 106 cm H 120 cm Pø 18 cm  
16 x E14 x 40W



Art. 1689/CH5/AV/RS  
 Ø 100 cm H 90 cm PØ 25 cm  
 5 x E14 x 40W

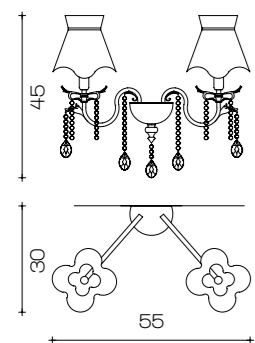

Art. 1689/A2  
 L 55 cm H 45 cm  
 Sp 30 cm PØ 18 cm  
 2 x E14 x 40W

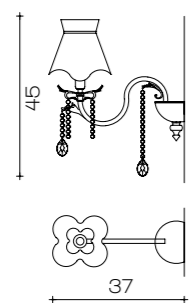

Art. 1689/A1/V1  
 PØ 18 cm H 45 cm  
 Sp 37 cm  
 1 x E14 x 40W

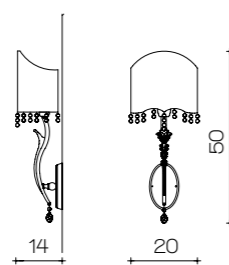

Art. 1689/A1/V2  
 L 20 cm H 50 cm  
 Sp 14 cm  
 1 x E14 x 40W



Art. 1689/P/OV/RS  
 H 47 cm PØ 20 cm  
 1 x E14 x 40W



Art. 1689/G/AV  
 H 63 cm PØ 30 cm  
 1 x E27 x 60W





Art. 1845/CH12/AV/TR  
H 104 cm ø 102 cm  
12 x E14 x 60W



Art. 1975/CH18/LU  
ø 144 cm H 128 cm  
18 x E14 x 40W



Art. 1845/A2/ORO24K  
L 60 cm H 33 cm  
Sp 35 cm Pø 20 cm  
2 x E14 x 40W





84

Art. 1845/CH8/ORO24K  
ø 84 cm H 90 cm Pø 20 cm  
8 x E14 x 40W



85

Il Paralume Marina

Art. 1845/FL/ORO24K  
ø 80 cm H 180 cm Pø 20 cm  
5 x E14 x 40W





Art. 1880/CH16/AV  
 ø 102 cm H 102 cm  
 16 x E14 x 40W

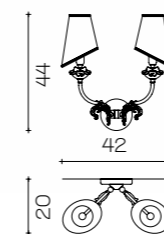

Art. 1774/A2  
 H 44 cm ø 42 cm  
 Pø 14 cm  
 2 x E14 x 40W

*Fantastico e al contempo prezioso e popolare, decorativo ed espressivo assieme, questo lampadario è in elementi di fusione di ottone cromato e rose di cristallo fiorentino pinzate a mano. I paralumi in organza viola rifiniti con passamaneria di perle e di cristalli trasparenti, creano atmosfere delicate e morbide.*

*Creative and precious, decorative and expressive at the same time, this chandelier is made of the elements fused in chromed brass and Florentine crystal roses clamped by hand. The lampshades in violet organza with pearls on the trimming and transparent crystals create delicate and soft atmosphere.*

*Популярная и ценная, экспрессивная и декоративная, воплощение яркого и неординарного воображения, эта люстра выполнена из хромированной латуни и вручную сделанных роз из флорентийского хрусталя. Абажуры из фиолетовой органзы, очерченные прозрачными кристалликами, создают мягкую и деликатную атмосферу.*



Art. 1774/A1  
 Sp 18 cm H 43 cm  
 Pø 14 cm  
 1 x E14 x 40W



Art. 1774/CH6  
 ø 84 cm H 55 cm Pø 14 cm  
 6 x E14 x 40W

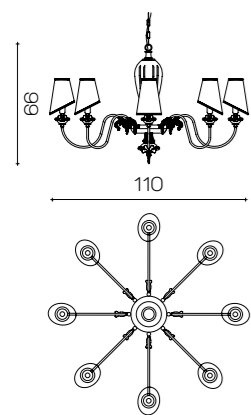

Art. 1774/CH8  
 ø 110 cm H 66 cm  
 Pø 14 cm  
 8 x E14 x 40W

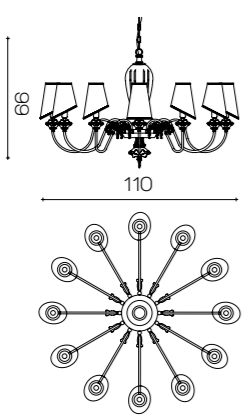

Art. 1774/CH12  
 ø 110 cm H 66 cm  
 Pø 14 cm  
 12 x E14 x 40W

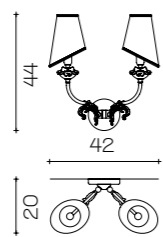

Art. 1774/A2  
 H 44 cm ø 42 cm  
 Pø 14 cm  
 2 x E14 x 40W



Art. 1774/CH12  
 ø 110 cm H 85 cm Pø 14 cm  
 12 x E14 x 40W





Art. 1140  
P ovale 35 x 26 cm H 50 cm  
1 x E27 x 60W



Art. 1138  
Pø 40 cm H 180 cm  
1 x E27 x 60W





Art. 2034/A2  
ø 45 cm H 50 cm Sp 35 cm  
2 x E14 x Led 5W



Art. 2034/CH36/LU  
ø 250 cm H 300 cm  
36 x E14 x Led 5W





94

Art. 2034/CH10  
ø 120 cm x H 100 cm Kg 80  
10 x E14 x Led 5W



95

Il Paralume Marina

Art. 2034/CH18/LU  
ø 160 cm H 200 cm  
18 x E14 x Led 5W





Art. VM 526  
 ø 80 cm H 75 cm  
 6 x E14 x 40W



Art. 2151/CH12  
 ø 108 cm H 76 cm  
 12 x E14 x 40W



Art. 2152/CH6  
Ø 75 cm H 73 cm  
6 x E14 x 40W



98



Art. 2153/CH6  
Ø 70 cm H 55 cm  
6 x E14 x Led



99

Il Paralume Marina

Art. 2155/CH5  
Ø 58 cm H 53 cm  
5 x E14 x Led





100

Art. 2035/A2/KR  
L 40 cm H 40 cm Sp 35 cm  
2 x E14 x 40W



101

Art. 2035/CH9/KR  
ø 115 cm H 140 cm  
9 x E14 x 40W

Il Paralume Marina





102

103

Art. 2035/CH12  
L 118 x 90 cm H 83 cm  
12 x E14 x Led

Art. 2035/CH20  
ø 120 cm H 100 cm  
20 x E14 x Led





104

Art. 1821/CH30  
ø 155 x H 140 cm  
30 x E14 x Led



105

Il Paralume Marina

Art. 1821/CH33  
ø 150 x H 200 cm  
33 x E14 x Led





106



107

Il Paralume Marina

Art. 2154/CH20  
ø 140 cm H 130 cm  
20 x E14 x led





Art. 2155/A2  
 H 45 cm ø 38 cm  
 2 x E14 x Led



Art. 2156/A1  
 H 45 cm ø 30 cm  
 1 x E14 x Led





110

Art. 2050/CH10  
ø 95 cm H 92 cm  
Pø 16 cm  
10 x E14 x 40W



Art. 2050/A2  
L 50 cm H 45 cm  
Sp 26 cm Pø 16 cm  
2 x E14 x 40W



111

Il Paralume Marina



*Lampadario in vetro di Murano  
Trasparente dalle linee sinuose ed  
equilibrate, definito con elementi in  
cromo od in oro coronato da paralumi  
cuciti in seta pura bianca su fodera  
bianca, passamaneria in cristalli  
luminosi Swarovski Elements.*



Art. 1801/CH15/KR  
ø 116 cm H 83 cm  
15 x E14 x 40W



Art. 1790/CH15/KR  
ø 123 cm H 83 cm Pø 16 cm  
15 x E14 x 40W

113

Il Paralume Marina



Art. 1792/CH9  
ø 82 cm H 73 cm  
9 x E14 x 40W



114

*Clear Murano glass chandelier by sinuous and balanced lines with elements in chrome or gold crowned with the lampshades sewn in pure white silk on the white lining, trimming in sparkling crystals by Swarovski Elements.*



115

Il Paralume Marina

Art. 1793/CH9  
ø 93 cm H 73 cm Pø 16 cm  
9 x E14 x 40W





Art. 1793/FL  
Ø 76 cm H 185 cm  
PØ 16 cm  
6 x E14 x 40W



Art. 1793/G  
H 85 cm PØ 45 cm  
1 x E27 x 60W



Art. 1793/A  
L 60 cm H 47 cm PØ 16 cm  
2 x E14 x 40W





Art. 1955/A2/LU  
L 52 cm H 60 cm  
Sp 34 cm  
2 x E14 x 40W



Art. 1955/P/LU  
Pø 34 cm H 70 cm  
1 x E27 x 40W

Art. 1955/G/LU  
Pø 46 cm H 95 cm  
1 x E27 x 60W



*Chandelier made with  
trasparent gold Murano  
glass with flames.*



Art. 1955/CH12/LU  
ø 120 cm H 80 cm  
12 x E14 x 40W







Art. 1955/FL/LU  
Pø 48 cm H 188 cm  
2 x E27 x 60W



Art. 1955/CH6/LU/GR  
ø 80 cm H 85 cm  
6 x E14 x 40W





Art. 1352/TA  
ø max 75 cm H 90 cm  
Pø 18 cm  
6 x E14 x 40W



Art. 1352/FL  
ø 75 cm H 185 cm  
Pø 18 cm  
6 x E14 x 40W



Art. 1352/CH18  
ø 120 cm H 100 cm  
Pø 18 cm  
18 x E14 x 40W







Art. 1352/A3  
ø max 75 cm H 70 cm  
Pø 18 cm  
3 x E14 x 40W



Art. 1352/CH6  
ø max 75 cm H 70 cm  
Pø 18 cm  
6 x E14 x 40W





Art. TL58  
 ø 45 cm H 76 cm  
 1 x 27 x 60W



Art. TL64  
 ø 72 cm H 64 cm  
 6 x E14 x 40W







Art. 1262/New/Bis  
Ø 90 cm H 100 cm  
9 x E14 x 40W



*Lampadario in vetro di Murano  
madreperlato, paralume in organza  
di seta azzurra con passamaneria  
in roselline bianche.*

Art. 1455  
Ø 90 cm H 80 cm  
PØ 14 cm  
9 x E14 x 40W





Art. 1381 Rosa  
ø 70 cm H 80 cm  
6 x E14 x 60W



*Lampadario in vetro di Murano bianco, paralume in chiffon nero su fodera avorio con passamaneria in palline di perline nere e bianche.*

*Chandelier in white Murano glass, lampshade in black chiffon on ivory lining and a white-black braid made on little balls of perls.*

*Люстра из белого Муранского стекла, абажур чёрного шифона на подкладке цвета слоновой кости с чёрным и белым бисером на борде.*

Art. 1381 Bianco  
ø 80 cm H 80 cm Pø 16 cm  
6 x E14 x 40W



*La magia del vetro soffiato, la padronanza del maestro vetraio, il sapore d'antico e di opera d'arte, sono tutti elementi caratterizzanti questo Lampadario in Murano in style Ca' Rezzonico, dalle decorazioni floreali scultoree frutto di alta maestria artigianale vetraia che sa emozionare.*

*The magic of blown glass, the skill of the master glassmaker, the flavour of antique ... all these are characterizing elements of this chandelier in Murano glass made in Ca' Rezzonico style, a masterpiece with sculptured floral decorations - creation of the high glass-working craftsmanship, the beauty that excites the senses.*

*Магия выдутого стекла, привкус обворожительной старины...эти черты присущи данной люстре из муранского стекла, выполненной в стиле Ca' Rezzonico. Произведение искусства с цветной лепкой от мастеров-стеклодувов, которое наполняет сердце эмоциями...*



Art. VM022/L12  
Ø 160 cm H 140 cm  
12 x E14 x 40W





Art. 1850/BI/TR  
Pø 43 cm H 105 cm  
1 x E27 x 60W

Art. 1850/KR/BLU  
Pø 43 cm H 105 cm  
1 x E27 x 60W

Art. 1850/ORO24K/FUME  
Pø 43 cm H 105 cm  
1 x E27 x 60W

Art. 1850/FO/RO  
Pø 43 cm H 105 cm  
1 x E27 x 60W







Art. 1850/CH36/ORO24K/NR  
ø 176 cm H 120 cm Pø 16 cm  
36 x E14 x 40W



Paralume in seta avorio  
su fodera dorata.

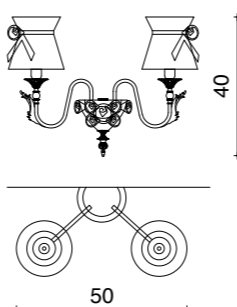
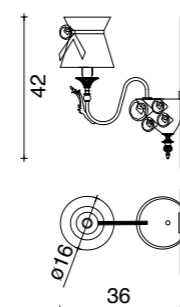

Art. 1850/CH12/ORO24K/NR  
Ø 107 cm H 73 cm PØ 16 cm  
12 x E14 x 40W

Art. 1850/A1  
H 42 cm PØ 16 cm  
Sp 36 cm  
1 x E14 x 40W

Art. 1850/A2  
L 50 cm H 40 cm  
Sp 28 cm  
2 x E14 x 40W

Art. 1850/P/ORO24K/FUMÉ  
PØ 32 cm H 82 cm  
1 x E27 x 60W

Art. 1850/G/ORO24K/FUMÉ  
PØ 43 cm H 105 cm  
1 x E27 x 60W



*Paralume in seta avorio  
su fodera argentata.*



Art. 1850/CH12/AV/RS  
Ø 107 cm H 73 cm PØ 16 cm  
12 x E14 x 40W

Art. 1850/AV/RS  
PØ 43 cm H 105 cm  
1 x E27 x 60W

141

Il Paralume Marina



*Paralume in seta avorio  
su fodera dorata.*



142



143

Art. 1850/FO/RO  
Pø 43 cm H 105 cm  
1 x E27 x 60W

Art. 1850/CH12/FO/RO  
ø 107 cm H 73 cm Pø 16 cm  
12 x E14 x 40W





144

Art. 1850/BI/TR  
Pø 43 cm H 105 cm  
1 x E27 x 60W



145

Art. 1842/CH6/BI  
ø 77 cm H 57 cm Pø 19 cm  
6 x E14 x 40W





Art. 1850/KR/BLU  
Pø 43 cm H 105 cm  
1 x E27 x 60W



Art. 1843/CH6/KR/BLU  
ø 77 cm H 57 cm Pø 19 cm  
6 x E14 x 40W





Art. 1870/CH6/OV  
 ø 77 cm H 57 cm Pø 19 cm  
 6 x E14 x 40W

148



Art. 1844/CH6/OV  
 ø 77 cm H 57 cm Pø 19 cm  
 6 x E14 x 40W



Art. 1850/OV/AM  
 Pø 43 cm H 105 cm  
 1 x E27 x 60W

149





Art. 1876  
ø 20 cm H 20 cm  
1 x E27 x 60W



Art. 1877  
ø 18 cm H 20 cm  
1 x E27 x 60W



Art. 1878  
ø 18 cm H 20 cm  
1 x E27 x 60W



Art. 1981  
ø 50 cm H 150 cm  
7 x E14 x 60W



Art. 1982  
ø 50 cm H 150 cm  
7 x E14 x 60W





Art. 1775/FL  
ø 60 cm H 220 cm  
5 x E14 x 60W



Art. 1775/CH6  
ø 76 cm H 148  
10 x E27 x 60W



Art. 1871  
Ø 73 cm H 46 cm  
6 x E27 x 40W



Art. 1872  
Ø 49 cm H 30 cm  
4 x E27 x 40W



Art. 1775/P  
Ø 31 cm H 64 cm  
1 x E27 x 60W



Art. 1775/A  
L32 cm H 35 cm Sp 15 cm  
4 x G9 x 40W







156

Chandelier with VINE LEAVES  
in metal and Murano Glass,  
lampshade in organza.

Art. 2171/CH12  
L 156 x 90 cm H 90 cm  
Pø 15 cm  
12 x E14 x Led

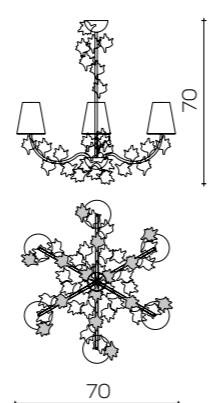

Art. 2171/CH6  
ø 70 cm H 70 cm  
Pø 12 cm  
6 x E14 x Led

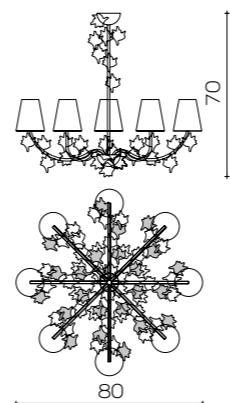

Art. 2171/CH8  
ø 80 cm H 70 cm  
Pø 12 cm  
8 x E14 x Led

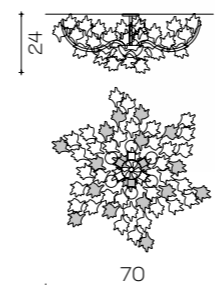

Art. 2171/Ceiling/G  
ø 70 cm H 24 cm  
6 x E14 x Led

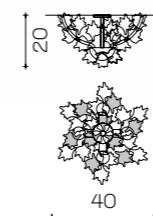

Art. 2171/Ceiling/P  
ø 40 cm H 20 cm  
4 x E14 x Led



157

Il Paralume Marina

Art. 2171/A3  
L 44 cm H 68 cm  
Pø 12 cm Sp 20 cm  
3 x E14 x Led





158



159

Il Paralume Marina

Art. 1627/CH24/BI/RS  
ø 120 cm H 115 cm  
Pø 14 cm  
24 x E14 x 40W





160

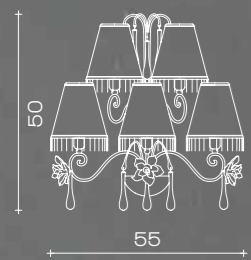

Art. 1627/A5  
 ø 55 cm H 50 cm  
 Sp 15 cm  
 Pø 14 cm  
 5 x E14 x 40W

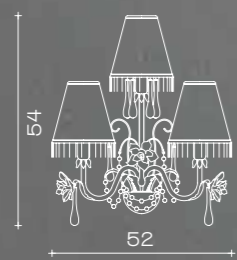

Art. 1627/A3  
 ø 52 cm H 54 cm  
 Sp 15 cm  
 Pø 14 cm  
 3 x E14 x 40W



Art. 1627/A1  
 L 18 cm H 35 cm  
 Sp 15 cm  
 Pø 14 cm  
 1 x E14 x 40W

Art. 1627/A2/B1/RS  
 L 40 cm H 40 cm  
 Sp 15 cm Pø 14 cm  
 2 x E14 x 40W



161



III Paraltume Marina

Art. 1627/CH5/B1/RS  
 ø 60 cm H 70 cm  
 Pø 14 cm  
 5 x E14 x 40W





Off

On



*Collezione dai delicati toni di elementi illuminanti legati al lampadario verniciato in bianco, dalla linea armonica ed essenziale decorato con rosette e gocce in vetro di Murano e cristalli Elements di Swarovski. I paralumi in pizzo avorio su fodera Pongè bosco, rifiniti con passamaneria in perline trasparenti creano un'atmosfera morbida e romantica.*

Art. 1627/CH12  
ø 87 cm H 90 cm Pø 14 cm  
12 x E14 x 40W





164

Art. 1743/CH12/OV  
 ø 87 cm H 90 cm Pø 14 cm  
 12 x E14 x 40W



165

Il Paratume Marina

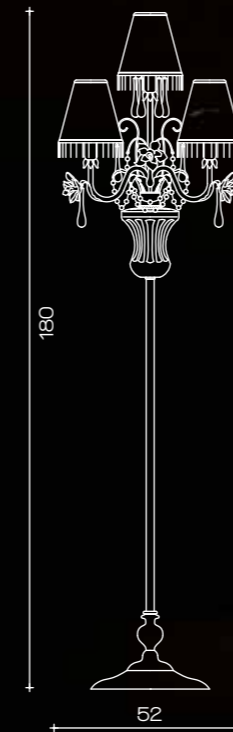

Art. 1627/FL  
 ø 52 cm H 180 cm Pø 14 cm  
 5 x E14 x 40W

Art. 1627  
 ø 52 cm H 82 cm Pø 14 cm  
 5 x E14 x 40W





Art. 1823/A2  
H 60 cm ø 48 cm Pø 20 cm  
2 x E14 x 40W



Art. 1823/CH8  
H 106 cm ø 104 cm  
Pø 20 cm  
8 x E14 x 40W



Art. 1823/Flambeaux  
ø 36 cm H 82 cm Pø 20 cm  
3 x E14 x 40W

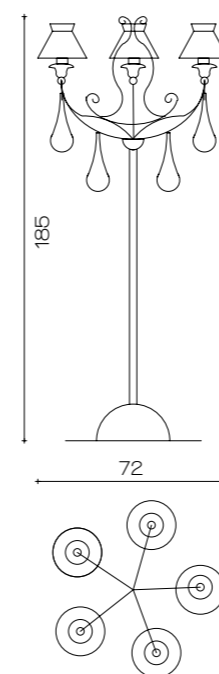

Art. 1823/FL  
ø 72 cm H 180 cm Pø 20 cm  
5 x E14 x 40W







Art. 1631/CH12/KR  
 Ø 160 cm H 65 cm PØ 18 cm  
 12 x E14 x 40W

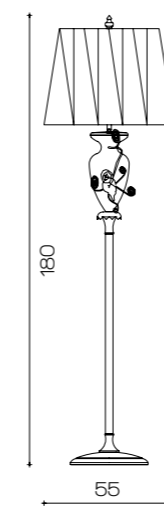

Art. 1631/FL  
 H 180 cm  
 PØ 55 cm  
 2 x E27 x 60W

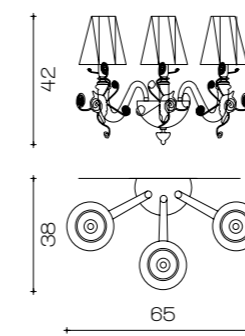

Art. 1631/A3  
 L 65 cm H 42 cm  
 Sp 38 cm PØ 16 cm  
 3 x E14 x 40W

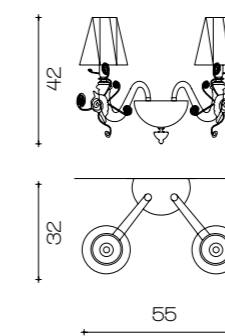

Art. 1631/A2  
 L 55 cm H 42 cm  
 Sp 32 cm PØ 16 cm  
 2 x E14 x 40W

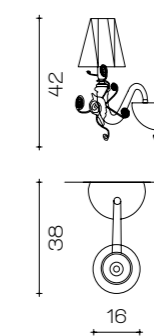

Art. 1631/A1  
 PØ 16 cm H 42 cm  
 Sp 38 cm  
 1 x E14 x 40W





Art. 1631  
Pø 45 cm H 81 cm  
1 x E27 x 60W

Art. 1631/CH4/OV  
ø 65 cm H 45 cm Pø 16 cm  
4 x E14 x 40W



*Raffinato lampadario in vetro di Murano trasparente e ottone finito in oro vecchio e applicazione di rose in metallo cromato, paralumi in seta avorio.*

*Elegant chandelier made of transparent Murano glass and brass finished in old gold, application of roses in chromed metal, ivory silk lampshades*

*Изящная люстра из прозрачного муранского стекла и латуни в покрытии под состаренное золото с аппликацией роз из тонких нитей хромированного металла, абажуры из шёлка цвета слоновой кости.*

Art. 1631/CH8/OV  
ø 120 cm H 58 cm Pø 16 cm  
8 x E14 x 40W





*Lampadario in vetro di Murano trasparente dalle proporzioni equilibrate, arricchito con bobeches ed elementi in cristallo Swarovski Elements coronato con paralumi in organza avorio.*

*Chandelier in transparent Murano glass with balanced proportions, embellished with bobeches and crystal Swarovski Elements, crowned with ivory organza lampshades.*

*Люстра из прозрачного муранского стекла с умело балансированными пропорциями, украшенная bobeches и кристаллами Swarovski Elements, коронованная абажурами из органзы цвета слоновой кости.*

Art. 1797/CH18  
H 130 cm ø 116 cm Pø 16 cm  
18 x E14 x 40W



Art. 1803/CH10/KR  
ø 106 cm H 70 cm  
10 x E14 x 40W



Art. 1711/FL/KR/TR  
ø 60 cm H 174 cm  
5 x E14 x 40W



Art. 1802/CH10/KR  
ø 85 cm H 70 cm  
10 x E14 x 40W





Art. 1711/CH12/KR/RO  
ø 90 cm H 140 cm  
12 x E14 x 40W



Art. 1711/CH12/KR/GR  
ø 90 cm H 140 cm  
12 x E14 x 40W



Art. 1711/G/KR/GR  
ø 50 cm H 75 cm  
5 x E14 x 40W



Art. 1711/G/KR/RO  
ø 50 cm H 75 cm  
5 x E14 x 40W



Art. 1711/G/KR/V  
ø 50 cm H 75 cm  
5 x E14 x 40W



Art. 1711/CH12/KR/V  
ø 90 cm H 140 cm  
12 x E14 x 40W







*Collezione di lampadari in cristallo trasparente e pendenti di Cristallo Swarovski Elements, paralumi in organza avorio. Un'eleganza che si rivela nell'equilibrata combinazione tra strutture essenziali e forme avvolgenti disegnate dai cristalli pendenti.*



178

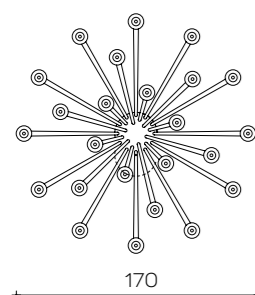

Art. 1761/CH24  
Ø 170 cm H 215 cm PØ 16 cm  
24 x E14 x 40W

179

Il Paralume Marina



Collection of the chandeliers made of clear crystal and Swarovski Elements pendants, ivory organza lampshades. Elegance that reveals itself in a well-balanced combination of essential structures and fascinating forms drawn by crystal pendants.

Коллекция люстр из прозрачного хрусталя с подвесками Swarovski Elements, абажуры из органзы цвета слоновой кости. Элегантность, воплощенная в комбинации эссенциальных структур и обволакивающих форм кристалльных подвесок.



Art. 1761/CH12/ovale  
L 165 x 95 cm H 115 cm Pø 16 cm  
12 x E14 x 40W





182

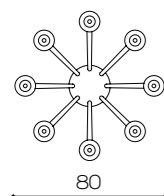

Art. 1761/CH8  
 ø 80 cm H 90 cm  
 Pø 16 cm  
 8 x E14 x 40W

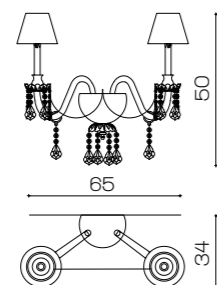

Art. 1761/A2  
 ø 65 cm H 50 cm  
 Pø 35 cm  
 2 x E14 x Led



183

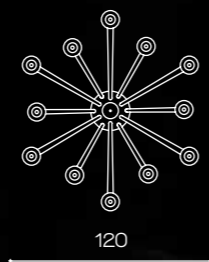

Art. 1761/CH12  
 ø 120 cm H 150 cm  
 Pø 16 cm  
 12 x E14 x 40W





184

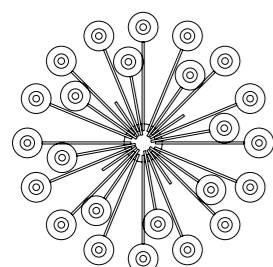
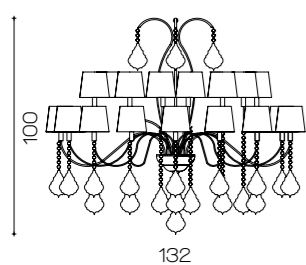

Art. 1742/CH24/KR  
 ø 132 cm H 100 cm  
 Pø 14 cm  
 24 x E14 x 25W

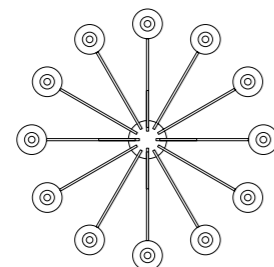
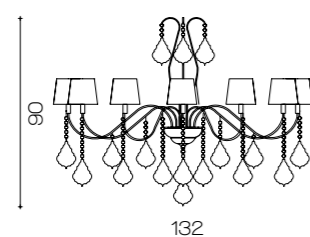

Art. 1742/CH12/KR/V1  
 ø 132 cm H 90 cm  
 Pø 14 cm  
 12 x E14 x 25W

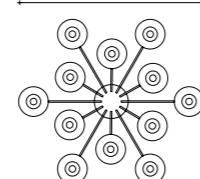
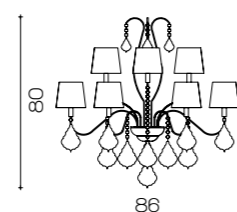

Art. 1742/CH12/KR/V2  
 ø 86 cm H 80 cm  
 Pø 14 cm  
 8 x E14 x 25W

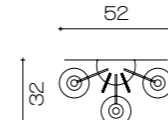
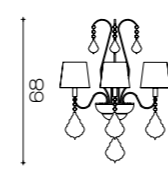

Art. 1742/A3/KR  
 ø 52 cm H 68 cm  
 Pø 14 cm  
 3 x E14 x 25W

185

Il Paralume Marina

Art. 1742/CH40/KR  
 ø 180 cm H 180 cm Pø 14 cm  
 40 x E14 x 25W



Art. 1742/CH8/KR  
ø 86 cm H 75 cm Pø 14 cm  
8 x E14 x 25W



Art. 1742/Flambeaux/KR  
ø 75 cm H 100 cm Pø 14 cm  
8 x E14 x 25W



Art. 1742/FL/KR  
ø 86 cm H 210 cm Pø 14 cm  
8 x E14 x 25W





188

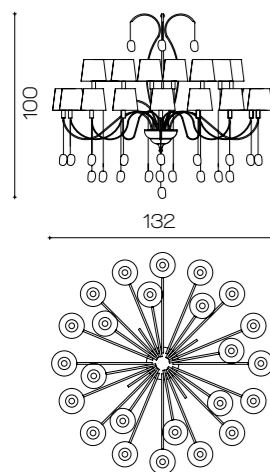

Art. 1710/CH24/OV  
ø 132 cm H 100 cm Pø 14 cm  
24 x E14 x 25W



189



Il Paralume Marina

Art. 1710CH40/KR/RS  
ø 180 cm H 180 cm Kg 40  
40 x E14 x 25W



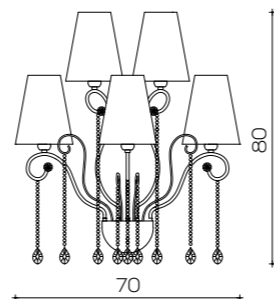

Art. 1630/A5  
 ø 70 cm H 80 cm Pø 18 cm  
 5 x E14 x 40W  
 Wall Sconce

Art. 1630/CH6/AV  
 ø 115 cm H 62 cm Pø 18 cm  
 6 x E14 x 40W  
 Antique silver

Art. 1630/CH18/AV  
 ø 115 cm H 100 cm Pø 18 cm  
 18 x E14 x 40W  
 Antique silver





192



Art. 1630/P  
Pø 25 cm H 48 cm  
1 x E14 x 40W

Art. 1630/G  
Pø 40 cm H 65 cm  
1 x E27 x 60W

*Piantana con paralume in organza  
tortora e fodera avorio.*

Art. 1389/FL  
Pø 55 cm H 180 cm  
2 x E27 x 60W  
Nappa N.10



193

Il Paralume Marina

Art. 1630/CH6/OV  
ø 115 cm H 65 cm Pø 18 cm  
6 x E14 x 40W





Art. 1244/A2  
ø max 50 cm H 50 cm  
2 x E14 x 40W

Art. 1244/CH12  
ø 95 cm H 90 cm Pø 16 cm  
12 x E14 x 40W





Art. 1319/FL KR  
ø 74 cm H 180 cm Pø 16 cm  
6 x E14 x 40W



Art. 1319/CH8  
ø 110 cm H 78 cm Pø 18 cm  
8 x E14 x 40W







Art. 1319  
 ø max 76 cm H 70 cm  
 Pø 16 cm  
 6 x E14 x 40W



*Cristallo Swarovski*



*Organza di seta con inserti Swarovski*

Art. 1320  
 ø max 60 cm H 70 cm Pø 16 cm  
 3 x E14 x 40W





Art. 1343  
ø max 42 cm H 45 cm Pø 15 cm  
2 x E14 x 40W



Art. 1290/G  
Pø 25 cm H 58 cm  
1 x E14 x 40W



200

Art. 1342  
ø max 50 cm  
H 172 cm  
Pø 15 cm  
2 x E14 x 40W



*Lampadario con sfere in vetro  
di Murano ambra, paralume in  
chiffon avorio su fodera gialla.*

Art. 1290/CH5/BIS  
ø max 80 cm H 50 cm Pø 16 cm  
5 x E14 x 40W

201





Art. 1505/CH5/LU  
Ø 75 cm H 90 cm PØ 16 cm  
5 x E14 x 40W



Art. 1443/G  
PØ 35 cm H 75 cm  
1 x E27 x 60W

Art. 1443/P  
PØ 22 cm H 43 cm  
1 x E14 x 40W

Lampada con tubo diamantato in  
ottone oro vecchio e inserti Swarovski.  
Paralume plissé avorio e bordo  
Swarovski ambra.





Art. 1451/BIS  
 ø 148 cm H 120 cm  
 20 x E14 x 40W



Art. 1505/CH4  
 ø 75 cm H 60 cm  
 Pø 16 cm  
 4 x E14 x 40W

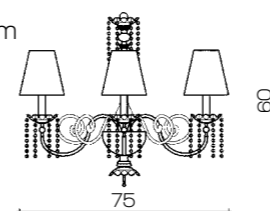

Art. 1506/CH8  
 ø 109 cm H 68 cm  
 Pø 16 cm  
 8 x E14 x 40W

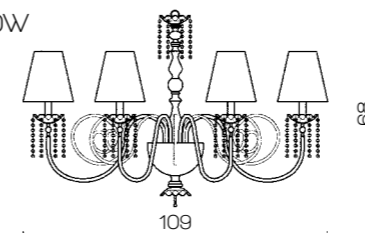

Art. 1507/CH8  
 ø 148 cm H 82 cm  
 Pø 18 cm  
 8 x E14 x 40W

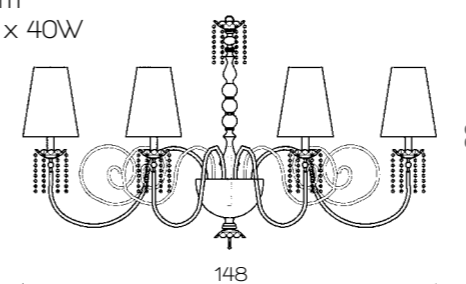

Art. 1508/CH12  
 ø 190 cm H 120 cm  
 Pø 20 cm  
 12 x E14 x 40W

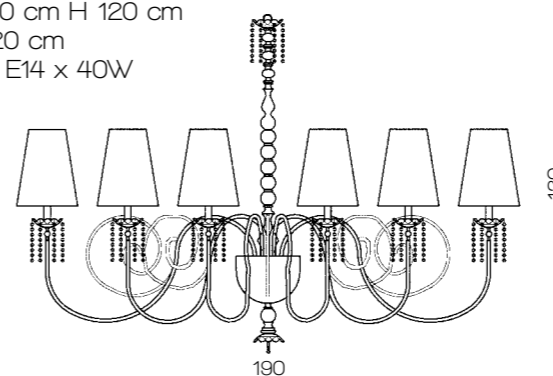

Art. 1451/CH32  
 ø 190 cm H 185 cm  
 32 x E14 x 40W

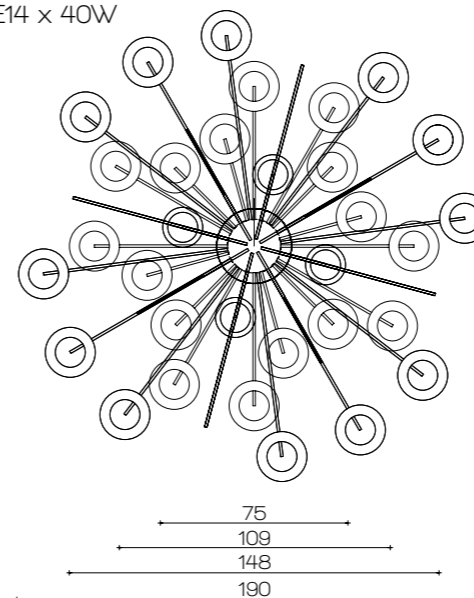

Art. 1451/FL/KR  
 ø 68 cm H 192 cm  
 Pø 16 cm  
 3 x E14 x 40W



*Lampadario in tubo diamantato cromato con piattini di cristallo e pendenti di Swarovski, paralume in seta pura lucida grigio antracite su fodera grigia.*

*Chandelier made of a special diamond cut of chrome brass tube, with crystal Swarovski saucers and pendants, lampshade in shining gray silk on gray lining.*

*Люстра из хромированных трубок с хрустальными блюдцами и подвесками из Swarovski, абажур из блестящей шелковой ткани с серой подкладкой.*

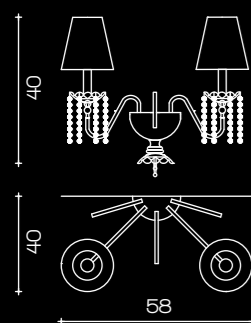

Art. 1451/A2 KR  
 ø 58 cm H 40 cm  
 Sp 30 cm Pø 16 cm  
 2 x E14 x 40W





*Lampadario con tubo diamantato in ottone  
e piattini di cristallo Swarovski, paralume in  
pieghe seta pura lucida avorio.*







*Plafoniera in ottone cromato con file di perle in pasta di vetro, paralume in tessuto dedar con motivo di cocodrillo stampato avorio.*

*Chandelier on chrome brass with pearls of paste's Murano glass, lampshade in Dedar pressed cocrodile ivory tissue.*

*Люстра из хромированной латуни с шариками из стеклянной пасты, абажур из ткани Dedar с темой крокодила цвета слоновой кости.*

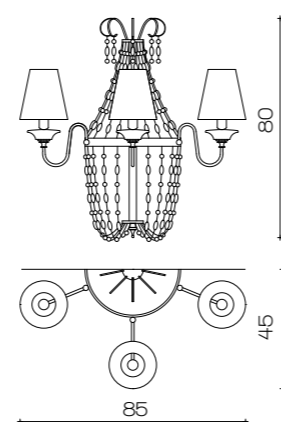

Art. 1445  
 ø 50 cm H 38 cm  
 4 x E14 x 40W

Art. 1380/A3  
 ø 85 cm H 80 cm Pø 18 cm  
 3 x E14 x 40W

Art. 1380/BI  
 ø 100 cm H 105 cm  
 Pø 18 cm  
 8 x E14 x 40W







*Sospensione con pendenti in vetro di Murano, paralume in chiffon avorio con Swarovski su fodera gialla.*

Art. 1498  
Ø 68 cm H 80 cm PØ 16 cm  
4 x E14 x 40W



Art. 1444  
Ø 30 cm H 50 cm  
2 x E14 x 40W

*Lampada con file di perle in: pasta di vetro - sfere di ottone Swarovski infilate a mano, paralume in chiffon avorio esterno su fodera seta avorio.*

Art. 1458  
PØ 43 cm H 84 cm  
1 x E27 x 60W





Art. TL132  
ø 50 cm H 80 cm  
1 x E27 x 60W



Art. TL130 Ambra  
ø 38 cm H 82 cm  
3 x E14 x 25W



Art. TL130 Ametista  
ø 38 cm H 82 cm  
3 x E14 x 25W







Art. 1607/FL  
Pø 56 cm H 180 cm  
3 x E14 x 40W



Art. 1607/CH5  
ø 80 cm H 50 cm  
Pø 16 cm  
5 x E14 x 40W



Art. 1607/A2  
ø 65 cm H 50 cm Pø 16 cm  
2 x E14 x 40W

Art. 1585/P  
Pø 33 cm H 64 cm  
1 x E27 x 40W



Art. 1585/G  
Pø 40 cm H 88 cm  
1 x E27 x 60W





Art. 1460/CH5  
 ø 76 cm H 40 cm Pø 16 cm  
 5 x E14 x 40W

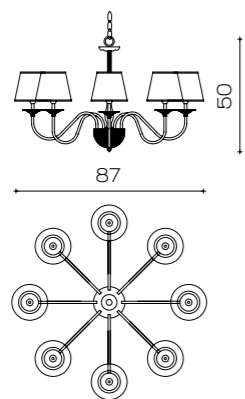

Art. 1460/CH8  
 ø 87 cm H 50 cm Pø 16 cm  
 8 x E14 x 40W

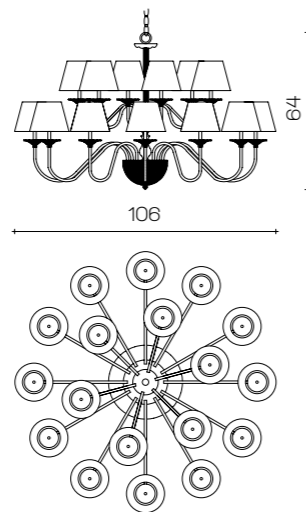

Art. 1460/CH18  
 ø 106 cm H 64 cm Pø 16 cm  
 18 x E14 x 40W

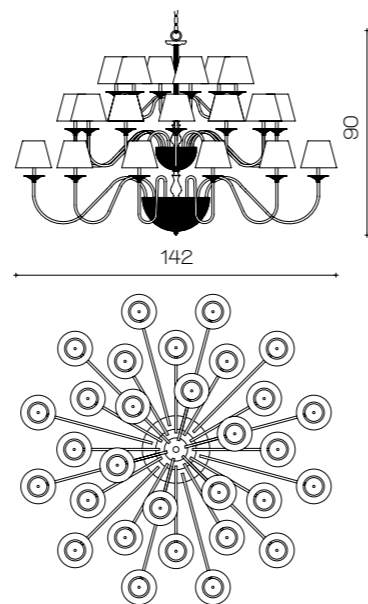

Art. 1460/CH30  
 ø 142 cm H 90 cm Pø 16 cm  
 30 x E14 x 40W



Art. 1460/FL  
 Pø 55 cm H 180 cm  
 2 x E27 x 60W  
 Nappa N.10

Art. 1875/G  
 Pø 35 cm H 70 cm  
 1 x E27 x 60W  
 Nappa N.30

Art. 1875/P  
 Pø 16 cm H 56 cm  
 1 x E14 x 40W







218

Art. 1325  
Pø 55 cm H 172 cm  
3 x E14 x 40W



219

Il Paralume Marina

*Scheggia di cristallo Fiorentino.*

Art. 1325/CH6  
ø max 84 cm H 80 cm Pø 16 cm  
6 x E14 x 40W





220

Art. 1324/M  
Pø 22 cm H 52 cm  
1 x E14 x 40W



Art. 1325/A1  
Pø 16 cm H 40 cm  
Sp 23 cm  
1 x E14 x 40W



221

Art. 1324/P  
H 39 cm Pø 16 cm  
1 x E14 x 40W

Art. 1324/G  
H 77 cm Pø 40 cm  
1 x E27 x 60W





*Lampadario con sfere in vetro di Murano ambra, paralume in chiffon avorio su fodera gialla.*

Art. 846/CH16  
ø 150 cm H 110 cm Pø 18 cm  
16 x E14 x 40W

Art. 872  
H 170 cm ø 45 cm  
3 x E14 x 40W



Art. 873  
ø 52 cm H 50 cm  
2 x E14 x 40W

223

Il Paralume Marina



Art. 846/A1  
ø 14 cm H 39 cm  
1 x E14 x 40W



Art. 846/A  
ø 50 cm H 45 cm  
2 x E14 x 40W



Art. 846/P  
ø 55 cm H 50 cm  
4 x E14 x 40W





Art. 846  
ø 90 cm H 80 cm Pø 16 cm  
8 x E14 x 40W



Art. 853/P  
ø 25 cm H 43 cm  
1 x E14 x 40W

Art. 853/G  
H 67 cm ø 45 cm  
1 x E27 x 60W







Art. 868  
ø 55 cm H 183 cm  
2 x E27 x 60W



Art. 869  
ø 40 cm H 180 cm  
1 x E27 x 100W

Art. 838  
ø 80 cm H 50 cm  
6 x E14 x 40W







Art. 709/G  
ø 66 cm H 58 cm Pø 16 cm  
5 x E14 x 40W



Art. 922/P  
ø 26 cm H 57 cm  
1 x E14 x 40W

Art. 922/G  
ø 35 cm H 77 cm  
1 x E27 x 60W







Art. 1287/G  
Pø 35 cm H 62 cm  
1 x E27 x 60W

Art. 1287/P  
Pø 25 cm H 46 cm  
1 x E14 x 40W

Art. 1249  
Pø 55 cm H 178 cm  
2 x E27 x 60W



Art. 1287/CH6  
H 80 cm max 75 cm Pø 16 cm  
6 x E14 x 40W





Art. 1636  
L 40 cm H 60 cm  
Sp 22 cm  
1 x E27 x 60W

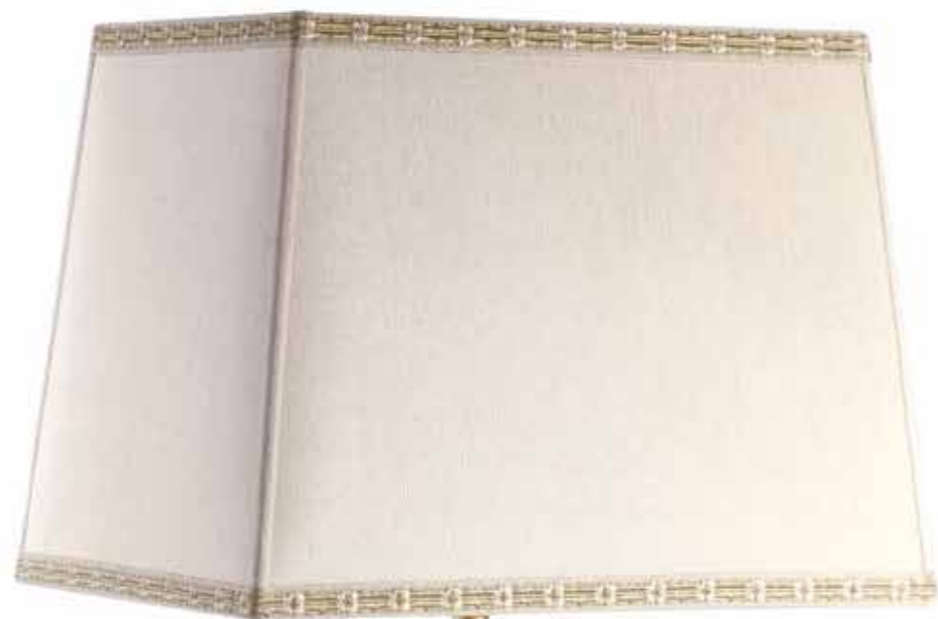

Art. 1638  
L 32 cm H 29 cm

Art. 1637  
L 31 cm H 58 cm Sp 22 cm  
1 x E27 x 60W

Art. 1602/CH3  
L 140 H 100 cm Pø 30 cm  
2 x E14 x 40W  
1 x Dicroica



Art. 1602  
Pø 38 cm H 68 cm  
1 x E27 x 60W



Art. 1602/FL  
Pø 50 cm  
H 180 cm  
1 x E27 x 60W





Art. 1848  
Pø 50 cm H 94 cm  
1 x E27 x 60W  
Nappa N.15







*Lampada in cristallo fiorentino  
24% piombo con incisioni fiori,  
paralume seta plissé su seta avorio.*

Art. 1632  
Pø 50 cm H 96 cm  
1 x E27 x 60W



Art. 1250  
ø max 30 cm  
H 60 cm  
Candles not included





Art. 1747/P/OV  
Pø 33 cm H 56 cm  
1 x E27 x 60W  
Nappa N.30 Bianca e Oro

Art. 1747/G/OV  
Pø 45 cm H 76 cm  
1 x E27 x 60W  
Nappa N.30 Bianca e Oro



Art. 1746/G/KR/New/Bis  
Pø 45 cm H 76 cm  
1 x E27 x 60W  
Nappa N.10 Argento

Art. 1746/P/KR/New/Bis  
Pø 33 cm H 56 cm  
1 x E27 x 60W  
Nappa N.10 Argento





242

Art. TL33/CG Bianca  
Pø 45 cm H 80 cm  
1 x E27 x 60W



243

Art. 1873/G  
Pø 45 cm H 80 cm  
1 x E27 x 60W

Art. 1873/P  
Pø 35 cm H 60 cm  
1 x E27 x 60W





Art. 1902/P  
Pø 35 cm H 63 cm  
1 x E27 x 60W

Art. 1902/G  
Pø 45 cm H 85 cm  
1 x E27 x 60W



Art. 1568/New/Bis  
Pø 45 cm H 70 cm  
1 x E27 x 60W  
Nappa N.1 Rossa





Art. 1568/P  
Pø 45 cm H 64 cm  
1 x E27 x 40W



Art. 1595/A1  
L 13 cm H 26 cm  
Sp 10 cm  
1 x E27 x 60W



Art. 1595/P  
L 13x13 cm H 26 cm  
1 x E27 x 60W

Art. 1595/G  
PL 46x24 cm H 73 cm  
1 x E27 x 60W

*Paralume rettangolare in organza oro  
su fodera avorio.*







Art. 1891  
 H 80 cm Pø 45 cm  
 1 x E27 x 60W



Art. 1596  
 H 85 cm Pø 45 cm  
 1 x E27 x 60W  
 1 x E14 x 40W (interna)





Art. 860  
ø 30 cm H 190 cm  
1 x E27 x 60W



*Paralume plissé in chiffon giallo  
foderato in seta gialla e cucito a  
mano. Cristallo fiorentino soffiato,  
temperato e molato a mano, fusione  
in terra d'ottone*

Art. TL57  
ø 45 cm H 80 cm  
1 x E27 x 60W  
1 x E14 x 40W (interna)





252

Art. TL53  
Pø 50 cm H 88 cm  
1 x E27 x 60W

*Cristallo fiorentino soffiato,  
temperato e molato a mano.  
Paralume in seta pura ambra  
foderato in seta avorio cucito a mano.*



253

Art. TL33  
Pø 45 cm H 80 cm  
1 x E27 x 60W

Art. TL33C  
Pø 45 cm H 80 cm  
1 x E27 x 60W

Il Paralume Marina

*Cristallo fiorentino soffiato a bocca e molato a mano. Paralume  
in seta avorio foderato in seta, cucito a mano*





254

Art. 885 Blu  
ø 38 cm H 75 cm  
1 x E27 x 60W



255

Art. TL86  
ø 45 cm H 80 cm  
1 x E27 x 60W





256

Art. TL87  
ø 45 cm H 80 cm  
1 x E27 x 60W



257

Art. 358/F  
ø 45 cm H 80 cm  
1 x E27 x 60W





258

Art. 1306/P/OVAM  
Pø 44 x 31 cm H 74 cm  
1 x E27 x 60W



259

Art. 1306/G/OVAM  
Pø 50x34 cm H 88 cm  
1 x E27 x 60W

Il Paralume Vianna





260

Art. 1306/G/OVTR  
Pø 45 cm H 88 cm  
1 x E27 x 60W  
Nappa N.1 strass Marrone/Oro

Art. 1306/P/OVTR  
ø 40 cm H 74 cm  
1 x E27 x 60W  
Nappa N.1 strass Marrone/Oro



261

Art. 1897/G  
Pø 45 cm H 88 cm  
1 x E27 x 60W  
Nappa N.48





Art. 480  
 H 75 cm  
 Pø 45 cm  
 1 x E27 x 60W



Art. 790  
 H 60 cm  
 Pø 33 cm  
 1 x E27 x 60W

Art. 789  
 H 80 cm  
 Pø 45 cm  
 1 x E27 x 60W







*Lampada in cristallo fiorentino molato a mano, paralume a sottana chiffon lilla e ricamo originale in perle avorio.*

Art. 1373/G  
 Pø 40 cm H 70 cm  
 1 x E27 x 60W  
 Nappa N.10

Art. 1373/P  
 Pø 32 cm H 54 cm  
 1 x E14 x 40W



Art. TL111  
 Pø 40 cm H 70 cm  
 1 x E27 x 60W





Art. 361  
Pø 45 cm  
H tot. 75 cm  
1 x E27 x 60W



Art. 358  
Pø 45 cm H 80 cm  
1 x E27 x 60W



Art. 359  
H 60 cm Pø 33 cm  
1 x E27 x 60W





Lampada in  
cristallo fiorentino  
molato a mano,  
paralume a sottana  
in pizzo avorio e  
bordo oro.

Art. 1544  
Pø 43 cm H 70 cm  
1 x E27 x 60W



Lampada in cristallo  
fiorentino molato  
a mano, paralume  
a sottana chiffon  
bordeaux e ricamo  
in Swarovski.

Art. 1545  
Pø 43 cm H 70 cm  
1 x E27 x 60W





270

Art. TL42  
Pø 40 cm H 75 cm  
1 x E27 x 60W



271



Il Paratume Marina

Art. 360  
Pø 45 cm H tot. 80 cm  
1 x E27 x 60W



Art. 525  
H tot. 40 cm  
Pø 30 cm Sp 25 cm  
1 x E14 x 40W



272

Art. 524  
H tot. 58 cm  
Pø 37 cm  
1 x E27 x 60W



Art. 523  
H tot. 160 cm  
Pø 40 cm P 25 cm  
1 x E27 x 60W



Art. 867  
ø 33 cm H 54 cm  
1 x E27 x 60W

Art. 870  
ø 28 cm H 43 cm  
1 x E27 x 60W

273

Il Paratume Marina





274

Art. 570  
 Pø 40 cm H tot. 70 cm  
 3 x E14 x 40W

Art. 570/C  
 Candles not included

Art. 560  
 Pø 25 cm  
 H tot. 45 cm  
 1 x E14 x 40W



275

Art. 856/M  
 ø 25 cm H 47 cm  
 1 x E14 x 40W

Art. 856/P  
 ø 20 cm H 36 cm  
 1 x E14 x 40W

Art. 856/G  
 ø 30 cm H 56 cm  
 1 x E27 x 60W





Art. 358/AM  
Pø 40 cm H 66 cm  
1 x E27 x 60W  
Cristallo Ambra



Art. 358/GR/BX  
Pø 40 cm H 66 cm  
1 x E27 x 60W  
Cristallo Grigio

Art. 358 NR/NR  
Pø 40 cm H 66 cm  
1 x E27 x 60W  
Cristallo Nero

Art. 358 TR/RO  
Pø 40 cm H 66 cm  
1 x E27 x 60W  
Cristallo Trasparente





Art. 1854  
Pø 45 cm H 89 cm  
1 x E27 x 60W  
Nappa N.10 ORO



Art. 1846  
Pø 48 x 35 cm H 83 cm  
1 x E27 x 60W  
Nappa N.10 ORO





Art. 1811/FL/KR  
ø 55 cm H 185 cm  
3 x E27 x 60W



Art. 1847  
Pø 45 cm H 86 cm  
1 x E27 x 60W  
Nappa N.42



Lampada in vetro di  
Murano, paralume in  
chiffon avorio plissé.



Art. 935/P  
Pø 40 cm H 68 cm  
1 x E27 x 60W



Art. 1531  
Pø 50 cm H 78 cm  
1 x E27 x 60W  
Nappa N.17







284

Art. 929/V  
ø 14 cm H 40 cm

Art. 929  
ø 45 cm H 84 cm  
1 x E27 x 60W



285

Art. 935  
ø 50 cm H 78 cm  
1 x E27 x 60W

Paralume Marina





286

Art. 943  
ø 28 cm H 193 cm  
1 x E27 x 60W



287

Il Paratume Marina

Art. 956  
ø 26 cm H 47 cm





Art. 936/BIS  
Pø 50 cm H 78 cm  
1 x E27 x 60W



Art. 957/G  
ø 30 cm H 44 cm

Art. 936  
ø 50 cm H 78 cm  
1 x E27 x 60W

Art. 957/P  
ø 50 cm  
H 78 cm





Art. 934/MRO  
Pø 35 cm H 55 cm  
1 x E27 x 60W



Art. 934/G  
Pø 45 cm H 81 cm  
1 x E27 x 60W





292

Art. TL1PP  
H 52 cm Pø 26 cm  
1 x E14 x 40W  
Nappa Fascetta

Art. TL1  
H 80 cm Pø 45 cm  
1 x E27 x 60W  
Nappa N.1 Marrone oro

Art. TL1P  
H 68 cm Pø 35 cm  
1 x E27 x 60W  
Nappa Fascetta



293

Il Paratime Marina

Art. TL1  
H 80 cm Pø 45 cm  
1 x E27 x 60W





Art. TL1R  
 Pø 45 cm H tot. 77 cm  
 1 x E27 x 60W  
 Nappa Grossa

Art. TL1 Piccola Oro  
 Pø 33 cm H tot. 58 cm  
 1 x E27 x 60W  
 Nappa Semplice



Art. 875  
 ø 45 cm H 85 cm  
 1 x E27 x 60W  
 Nappa Grossa





*Lampada in vetro di murano soffiata a bocca ambra. Paralume in chiffon avorio con fodera in seta gialla bordo barocco ambra/oro.*

Art. 748  
H 55 cm Pø 33 cm  
1 x E27 x 60W  
Nappa Pon Pon



Art. 747  
H 77 cm Pø 45 cm  
1 x E27 x 60W  
Nappa Pon Pon

*Paralume in chiffon avorio foderato in seta gialla con bordo oro-barocco vetro di murano soffiato a bocca ambra e oro. Fusione artigianale in terra, eseguita su stampi colata a mano.*



Art. TL12  
H 52 cm Pø 30 cm  
1 x E27 x 60W  
Nappa semplice oro

Art. TL13  
H 75 cm P ovale 40 cm  
1 x E27 x 60W  
Nappa Pon Pon





Art. 574/B  
H min 150 cm  
max 180 cm  
Pø 35 cm  
1 x E27 x 60W



Art. 701  
H 105 cm ø 45 cm  
1 x E27 x 60W



Art. 702  
H 45 cm ø 22 cm  
1 x E14 x 40W

Art. 638P  
H 46 cm Pø 29 cm  
1 x E14 x 40W



Art. TL2P  
H 41 cm Pø 25 cm  
1 x E14 x 40W



Art. 445P  
H 57 cm Pø 25 cm  
1 x E14 x 40W







Art. 150  
H 59 cm P quadro 33x24 cm  
2 x E14 x 40W

Art. 603  
H 70 cm Pø 30 cm  
1 x E27 x 60W

Art. 756P  
H 39 cm Pø 26 cm  
1 x E14 x 40W



Art. 905  
H 35 cm ø 33 cm  
ventola ø 11 cm  
2 x E14x 25W



Art. 638/A  
H 42 cm L 27 cm  
1 x E27 x 25W



Art. 862  
Pø 50 cm H 180 cm  
2 x E27 x 60W





302

Art. TL2  
H tot. 80 cm Pø 48 cm  
1 x E27 x 60W

Art. TL3  
H tot. 170 cm Pø 55 cm  
1 x E27 x 60W



Art. 614  
H tot. 55 cm Pø 44 cm  
3 x E14 x 40W

Art. 516 R  
H tot. 160 cm  
Pø 40 cm  
1 x E27 x 60W

Art. 606  
H 55 cm  
Pø 40 cm

Art. 617  
H tot. 43 cm Pø 20 cm  
1 x E14 x 40W

303

Il Paratume Marina







304

Art. 953/BIS  
H 182 cm ø 50 cm  
2 x E27 x 60W



305

Il Paralume Marina

Art. 926/G  
H 77 cm ø 40 cm  
1 x E27 x 60W

Art. 926/P  
H 49 cm ø 25 cm  
2 x E14 x 40W





306

Art. 969  
H 88 cm ø 45 cm  
3 x E14 x 40W



307

Il Paratume Marina

Art. 969/B  
H 88 cm ø 45 cm Pø 16 cm  
3 x E14 x 40W





308

Art. TL68  
H 68 cm ø 50 cm  
3 x E14 x 40W

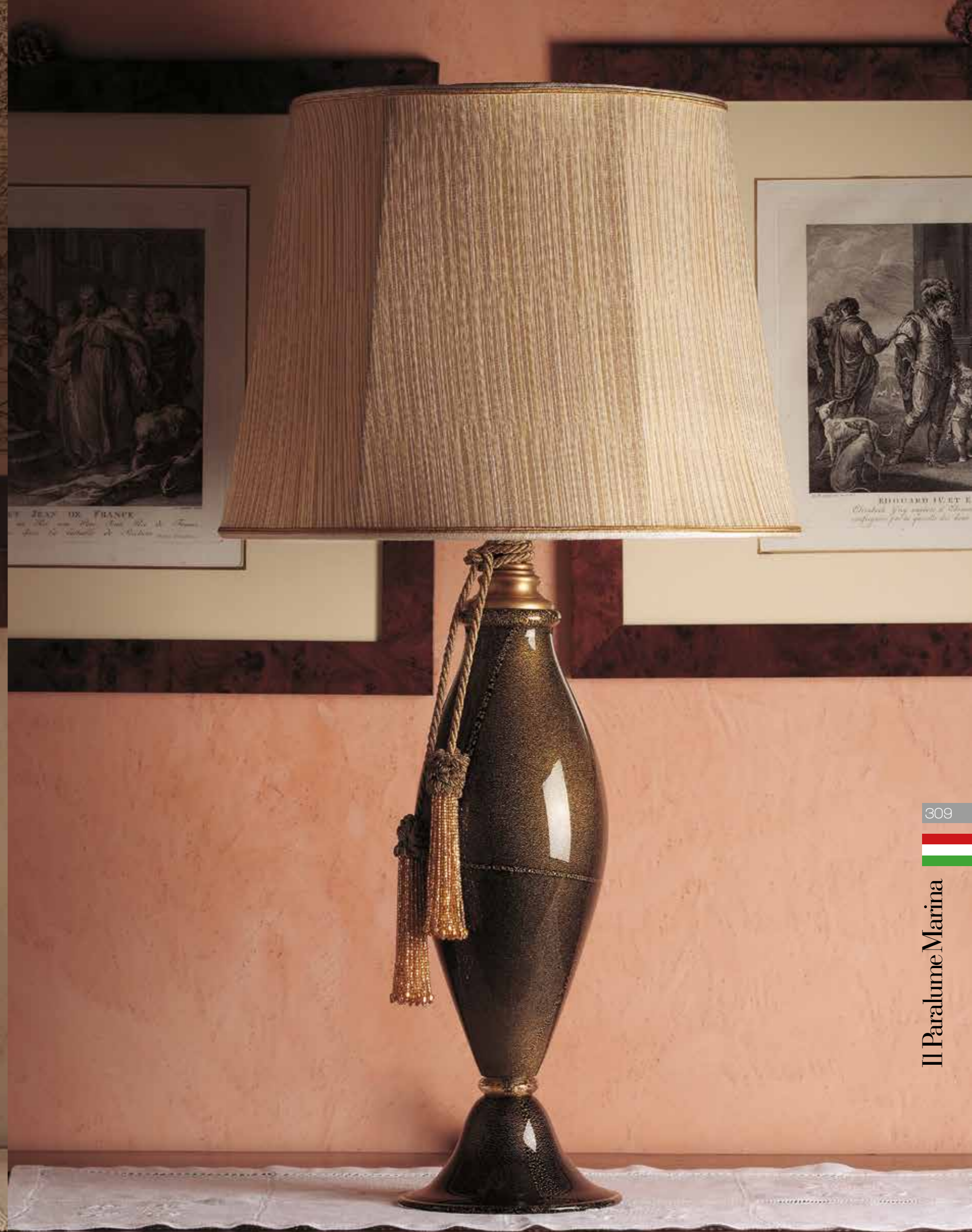

309

Art. TL63  
H 78 cm ø 40 cm  
1 x E27 x 60W  
Nappa N.1 Oro





Art. 644  
H 67 cm ø 40 cm  
3 x E14 x 40W



Art. 644/A  
H 60 cm ø 35 cm  
Sp 19 cm  
2 x E14 x 40W



Art. 633  
H 56 cm  
ø 35 x 17 cm  
2 x E14 x 40W



Art. 827  
H 90 cm ø 46 cm  
3 x E14 x 40W





312

Art. 911  
H 47 cm ø 15 cm  
1 x E14 x 40W

Art. 912  
H 55 cm ø 18 cm  
1 x E27 x 40W



Art. 910  
H 160 cm ø 25 cm  
estensione max  
braccio 38 cm  
1 x E27 x 60W



313

Il Paratume Marina



Art. 314  
H tot. 53 cm  
Pø 40 cm ø base 25 cm  
2 x E27 x 60W



Art. 312  
H tot. 46 cm L 30 cm  
ø base 25 cm  
1 x E27 x 60W



Lamp on

Lamp off



315



Art. 313  
H 45 cm P 22x14 cm  
ø base 25 cm  
1 x E27 x 60W



Art. 1433/KR  
H 50 cm L 38 cm  
1 x E27 x 60W



Art. 1433/BI  
H 50 cm L 38 cm  
1 x E27 x 60W







Art. 184  
H tot. 180 cm  
Pø 45 cm  
Sp max 50 cm  
1 x E27 x 60W



Art. 182  
H tot. 163 cm  
Pø 50 cm  
1 x E27 x 60W



Art. 426  
H tot. 170 cm Pø 50 cm  
1 x E27 x 60W







Art. 516  
H tot. 160 cm  
Pø 40 cm  
1 x E27 x 60W



Art. 331  
H tot. 160 cm Pø 30 cm  
1 x E27 x 60W



Art. 443  
H tot. 165 cm Pø 40 cm  
1 x E27 x 60W



Art. 967  
H 184 cm ø 60 cm  
3 x E14 x 40W  
Nappa N.1 marrone oro







320

Art. 845  
H 190 cm ø 60 cm  
2 x E27 x 60W



321

*Piantana oro vecchio modello  
bridge da lettura, paralume in seta  
pura ricamata e fodera avorio.*

Art. 124/BIS  
H 180 cm Pø 47 cm  
1 x E27 x 60W





322

Art. 863  
H 210 cm  
1 x E27 x 60W



323

Art. TL25  
H 30 cm ø 21 cm  
Sp 18 cm  
1 x E14 x 40W

Art. TL23  
H 37 cm ø 28 cm  
1 x E27 x 100W



324



Art. 909  
 ø 28 cm H 45 cm  
 Pø 11 cm  
 2 x E14 x 25W

325



Art. 420/B  
 ø 47 cm H 44 cm  
 3 x E14 x 40W

Il Paralume Marina

APPLIQUES





Art. 421  
Pø 18 cm  
H tot. 52 cm  
1 x E14 x 40W



Art. 420  
Pø 16 cm  
Ø 42 cm x H 42 cm  
3 x E14 x 40W



Art. 422  
Pø 18 cm  
H tot. 52 cm  
Ø 40 x H 50 cm  
2 x E14 x 40W



Art. 419  
Pø 60 cm  
H tot. 170 cm  
Oval 50 cm x 30 cm  
2 x E27 x 60W



Art. 418  
Pø 45 cm  
H tot. 65 cm  
Oval 42 cm x 26 cm  
2 x E27 x 40W





Art. 588/B  
ø 43 cm H 37 cm  
Pø 14 cm  
2 x E14 x 40W

Art. 590/CH6  
ø 70 cm H 50 cm  
Pø 18 cm  
6 x E14 x 40W



Art. 588  
ø 36 cm  
H 37 cm Sp 17 cm  
2 x E14 x 40W



Art. 587  
ø 23 cm H 36 cm  
Sp 16 cm  
1 x E27 x 40W



Art. 586  
Pø 30 cm  
H 54 cm  
1 x E27 x 40W



Art. 585  
Pø 17 cm  
H 43 cm  
1 x E14 x 40W



Art. 589  
Pø 50 cm  
H 170 cm  
3 x E14 x 40W







Art. 567  
H 30 cm Pø 31 cm  
2 x E14 x 40W



Art. 569/3  
H 55 cm  
Pø 35 cm  
3 x E14 x 40W



Art. 569/2  
H 55 cm Pø 33 cm  
2 x E14 x 40W



Art. 564  
H 170 cm Pø 50 cm  
4 x E14 x 40W

Art. 565  
H 170 cm Pø 50 cm  
2 x E14 x 40W



Art. 404  
H 12 cm Pø 25 cm  
Sp 25 cm  
1 x E27 x 40W



Art. 432  
Pø 47 cm  
1 x E27 x 60W







Art. 779  
H 170 cm Pø 48 cm  
3 x E14 x 40W

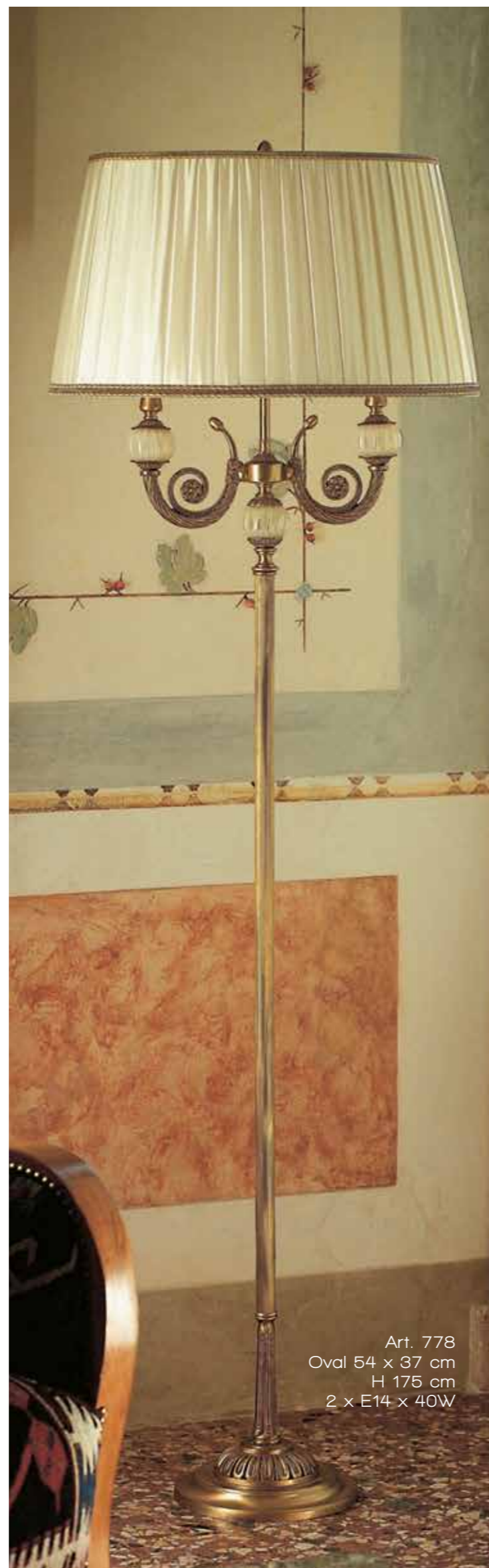

Art. 778  
Oval 54 x 37 cm  
H 175 cm  
2 x E14 x 40W



Art. 707  
ø 20 cm H 45 cm  
Sp 12 cm  
1 x E14 x 25W

Art. 709  
ø 74 cm  
5 x E14 x 40W

Art. 705  
Oval 30 x 22 cm  
H 56 cm  
1 x E27 x 40W

Art. 706  
Oval 25 x 18 cm  
H 42 cm  
1 x E14 x 40W

Art. 708  
Oval 54 x 37 cm  
H 166 cm  
2 x E27 x 60W





Art. 590/S  
ø 78 cm H 45 cm  
6 x E14 x 40W



Art. TL26  
ø 105 x H 62 cm  
6 x E14 x 40W



Art. 633/3  
H 60 cm Pø 35 cm  
3 x E14 x 40W

Art. TL40  
H 175 cm Pø 55 cm  
2 x E27 x 60W



Art. 520  
ø 76 cm H 45 cm  
Pø 16 cm  
6 x E14 x 40W



Art. 521  
H 35 cm L 45 cm  
Pø 16 cm  
2 x E14 x 40W



Art. 464  
ø 30 cm H 20 cm  
1 x E27 x 60W



Art. 466  
ø 30 cm H 25 cm  
1 x E27 x 60W



Art. 151  
H tot. 56 cm Pø 31 cm  
2 x E14 x 25W



336

337





Art. 627  
ø 18 cm H 38 cm  
1 x E14 x 25W



Art. 628  
ø 37 cm H 34 cm  
Sp 14 cm  
2 x E14 x 25W



Art. 232  
ø 57 cm H 35 cm  
Pø 14 cm  
2 x E14 x 25W



Art. 311  
ø 120 cm H 40 cm  
Pø 40 cm  
4 x E27 x 25W





Art. 1510  
L 36 cm H 62 cm  
4 x G9 x 25W



*Appliques foglia oro con pendenti Swarovski, ventola in seta pura e ricamo Swarovski.*



Art. 1397/A2  
L 35 cm H 56 cm  
2 x E14 x 25W

Art. 1393/A3  
L 50 cm H 70 cm  
3 x E14 x 25W







Art. 851  
 ø 133 cm H 93 cm  
 2 x E27 x 60W



Art. 431/C  
 ø 55 cm H 38 cm  
 2 x E14 x 25 W



Art. 554  
 ø 116 cm H 50 cm Pø 16 cm  
 8 x E14 x 25W



Art. 431/B  
 ø 42 cm H 42 cm  
 2 x E14 x 25W





Art. 504  
H 70 cm ø 50 cm  
1 x E27 x 40W



Art. 505  
H 70 cm ø 40 cm Pø 28 cm  
1 x E27 x 40W



Art. 346  
H 27 cm L 26 cm  
1 x E27 x 25W



Art. 280  
H 35 cm L 18 cm  
1 x E27 x 25W



Art. 526  
H 20 cm Pø 28 cm  
L max 54 cm  
1 x E27 x 40W



Art. 527  
H 18 cm Pø 27 cm  
Sp 18  
1 x E27 x 40W



Art. 535  
H 30 cm ø 27 cm  
1 x E27 x 25W



Art. 347  
H 47 cm L 25 cm  
1 x E27 x 25W



Art. 324  
H 35 cm L 26 cm  
1 x E27 x 25W







346

Art. 408  
H 55 cm ø 30 cm  
1 x E27 x 40W



Art. 399  
H 40 cm ø 35 cm  
1 x E27 x 40W



Art. 431  
H 38 cm L 30 cm  
Pø 12 cm  
2 x E27 x 25W

Art. 407  
L 27 cm H 48 cm  
Sp 6 cm



Art. 405  
L 27 cm H 30 cm  
Sp 10 cm

Art. 406  
L 36 cm H 28 cm  
Sp 17 cm



347





Art. 342/B  
Ø 80 cm H 38 cm  
PØ 16 cm  
6 x E14 x 40W



Art. 975  
Ø 80 cm H 45 cm  
PØ 16 cm  
8 x E14 x 25W



Art. 1540  
Ø 105 cm H 55 cm PØ 16 cm  
8 x E14 x 25W





Art. M21  
H tot. 175 cm ø 55 cm  
Nappa Grossa Oro  
2 x E27 x 60W



Art. 512  
H tot. 135 cm  
H tot. 160 cm Pø 28 cm  
1 x E27 x 60W



Art. 262 T  
H max 210 cm min 175 cm  
Tavolo ø 40 cm Pø 60 cm  
1 x E27 x 60W





Art. 551  
Ø 66 cm  
H 60 cm  
3 x E14 x 40W



Art. 552  
Ø 76 cm H 60  
6 x E14 x 40W



Art. 553  
Ø 86 x H 62 cm  
8 x E14 x 25W



Art. 342/P1  
Ø 76 cm H 38 cm  
PØ 16 cm  
6 x E14 x 40W



Art. 506  
H 35 cm Ø 27 cm  
1 x E27 x 25W



Art. 534  
H 46 cm  
Ø 34 cm  
2 x E14  
x 40W



Art. 507  
PØ 26 cm H tot. 32 cm  
1 x E27 x 25W



Art. 508  
PØ 38 cm H tot. 45 cm  
1 x E27 x 40W







Art. 902  
ø 37 cm H 90 cm  
1 x E27 x 60W

Art. 903  
ø 37 cm H 90 cm  
1 x E27 x 60W



Art. 463  
ø 50 cm  
1 x E27 x 60W



Art. 465  
H tot. 20 cm  
Pø 30 cm Sp 20 cm  
1 x E27 x 60W





356



357

Il Paralume Marina

Art. 2041/CH5/KR  
L 290 cm ø 48 cm H 110 cm  
5 x E27 x 60W





Art. 2157/CH5  
 L 250 cm x ø 45 cm  
 H max 235 cm  
 5 x E27 x Led



Art. 1852/BI  
 ø 36 cm H 40 cm  
 1 x E27 x 60W

Art. 1822  
 ø 50 cm H 60 cm  
 1 x E27 x 60W





*La fusione d'ottone in questa collezione di lanterne, si veste di diversi stili espressivi, da brunito classico, al cromato contemporaneo, fino al bianco provenzale.*

*In this collection of the lanterns brass fusion acquires different expressive styles: from classic bronzed till contemporary chromed and white colours.*

*Латунь в этой коллекции фонарей обретаёт разные экспрессивные формы, цвета и стили: от классического бронзового до современного хромированного и белого.*

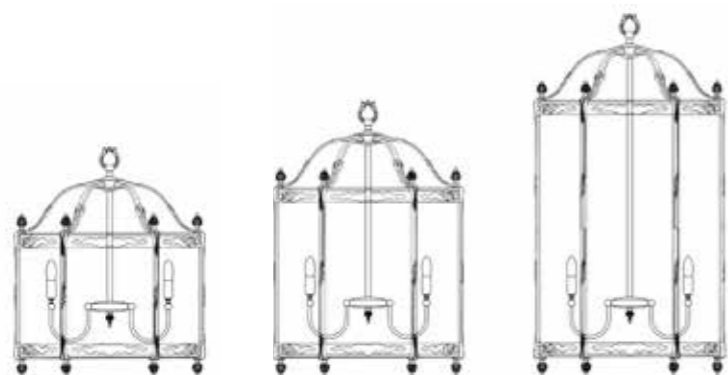

Art. 1881/P  
 ø 63 cm H 76 cm  
 6 x E27 x 40W

Art. 1881/M  
 ø 63 cm H 91 cm  
 6 x E27 x 40W

Art. 1881/G  
 ø 63 cm H 120 cm  
 8 x E27 x 40W



Art. 1804/G/BR  
 ø 44 cm H 85 cm  
 5 x E27 x 40W



Art. 1838  
 ø 47 cm H 75 cm  
 5 x E14 x 40W



362



Art. 1804/M/BI  
ø 34 cm H 66 cm  
3 x E14 x 40W

363



Art. 1804/P/KR  
ø 21 cm H 40 cm  
1 x E27 x 60W



*“i Sottoporteghi”*



Art. 763  
L asta 80 cm  
1 x E27 x 60W



Art. 734  
ø 30 cm H 22 cm  
Sp 67 cm  
1 x E27 x 60W



Art. 738  
ø 30 cm H 45 cm  
Sp 60 cm  
1 x E27 x 60W



Art. 733  
ø 25 cm H 14 cm  
Sp 50 cm  
1 x E27 x 60W



Art. 763  
L asta 80 cm  
1 x E27 x 60W

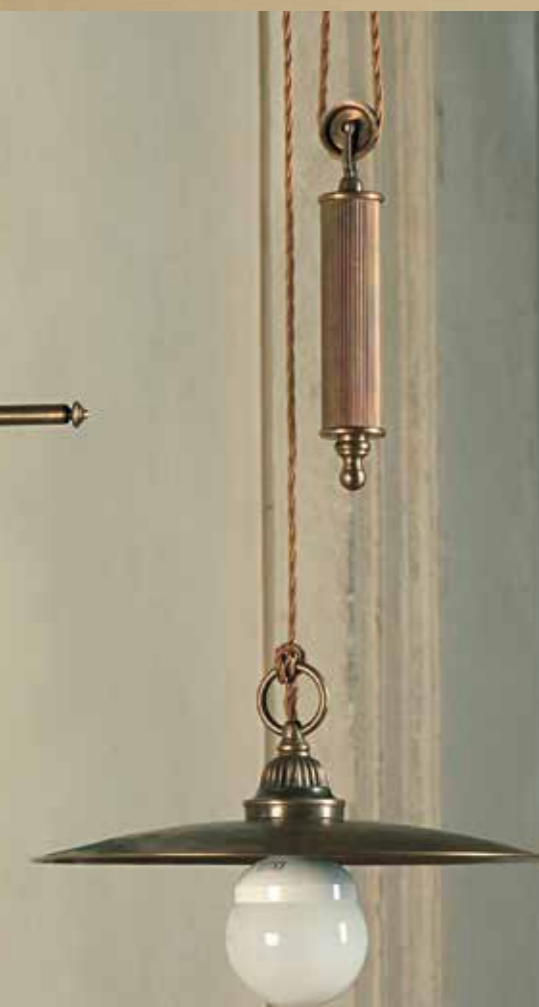

Art. 764  
H 60 cm / 130 cm  
Piatto ø 30 cm  
1 x E27 x 60W





Art. 737  
 ø 35 cm H 32 cm  
 Sp 97 cm  
 1 x E27 x 60W

Art. 740  
 ø 35 cm H 62 cm  
 Sp 71 cm  
 1 x E27 x 60W



Art. 736  
 ø 30 cm H 32 cm  
 Sp 72 cm  
 1 x E27 x 60W



Art. 735  
 ø 25 cm H 27 cm  
 Sp 36 cm  
 1 x E27 x 60W



Art. 739/F  
 ø 25 cm H 19 cm  
 Sp 35 cm  
 1 x E27 x 60W



Art. 739  
 ø 25 cm H 19 cm  
 Sp 35 cm  
 1 x E27 x 60W



Art. 762  
 ø 45 cm  
 1 x E27 x 60W



Art. 761  
 H 40 cm Sp 30 cm  
 1 x E27 x 60W



Art. 792  
 L 98 cm  
 H max 120 cm min 80 cm  
 1 x E27 x 60W

Art. 793  
 L 130 cm  
 H max 120 cm min 80 cm







AC 3

filo seta

AC 1

Art. 739/F  
 H 19 cm Sp 35 cm  
 1 x E27 x 60W



Art. 884  
 Sp 77 cm ø 35 cm  
 1 x E27 x 60W



NON INCLUSI: Lampadina, Portalampane  
 NOT INCLUDED: Bulb, Lamp holder  
 НЕ ВКЛЮЧЕНЫ: Лампочка, Патрон



Art. 1816/LU/VERDE  
 ø est 100 mm  
 ø int 53 mm  
 ø foro per incasso 65 mm  
 completo di molle/with screws

Available on green, red, blue enamel  
 Disponibile in lacca verde, blue e rossa.



Art. 1882/LU  
 ø est 140 mm  
 ø int 52 mm  
 ø foro per incasso 75 mm  
 completo di molle/with screws



Art. 2048/NL  
 L 100 x 100 mm ø int 52 mm  
 ø foro per incasso 65 mm  
 completo di molle/with screws



Art. 2047/NL  
 L 100 x 100 mm ø int 52 mm  
 ø foro per incasso 65 mm  
 completo di molle/with screw



Art. 1819/OV  
 ø est 100 mm  
 ø int 52 mm  
 ø foro per incasso 65 mm  
 completo di molle/with screws



Art. 1819/KR  
 ø est 100 mm  
 ø int 52 mm  
 ø foro per incasso 65 mm  
 completo di molle/with screws



Art. 1819/BI  
 ø est 100 mm  
 ø int 52 mm  
 ø foro per incasso 65 mm  
 completo di molle/with screws



Art. 1815/KR  
 ø est 100 mm  
 ø int 52 mm  
 ø foro per incasso 65 mm  
 completo di molle/with screws



Art. 1817/LU/BLU  
 ø est 100 mm  
 ø int 52 mm  
 ø foro per incasso 65 mm  
 completo di molle/with screws

Available on green, red, blue enamel  
 Disponibile in lacca verde, blue e rossa.



Art. 1817/LU/ROSSO  
 ø est 100 mm  
 ø int 52 mm  
 ø foro per incasso 65 mm  
 completo di molle/with screws

Available on green, red, blue enamel  
 Disponibile in lacca verde, blue e rossa.







Art. 1856/KR  
 L x L 410 mm  $\varnothing$  int 52 mm  
 $\varnothing$  foro per incasso 85 mm  
 H max 25 mm completo  
 di molle/with screws



Art. 1857/BR orientabile  
 $\varnothing$  est 120 mm  $\varnothing$  int 52 mm  
 $\varnothing$  foro per incasso 85 mm  
 H max 35 mm  
 completo di molle/with screws



NON INCLUSI: Lampadina, Portalampane  
 NOT INCLUDED: Bulb, Lamp holder  
 НЕ ВКЛЮЧЕНЫ: Лампочка, Патрон

Art. 1883/KR  
 $\varnothing$  est 125 mm  
 $\varnothing$  int 52 mm H 180 mm  
 $\varnothing$  foro per incasso 65 mm  
 completo di molle/with screws



NON INCLUSI: Lampadina, Portalampane  
NOT INCLUDED: Bulb, Lamp holder  
НЕ ВКЛЮЧЕНЫ: Лампочка, Патрон



Art. 1884/KR  
ø est 260 mm H 40 cm  
5 x G9



Art. 1858/FO  
ø est 125 mm ø int 53 mm  
ø foro per incasso 65 mm H 140 mm  
completo di molle/with screws



Art. 1886/KR  
ø est 125 mm ø int 53 mm  
H 140 mm ø foro per incasso 65 mm  
completo di molle/with screws

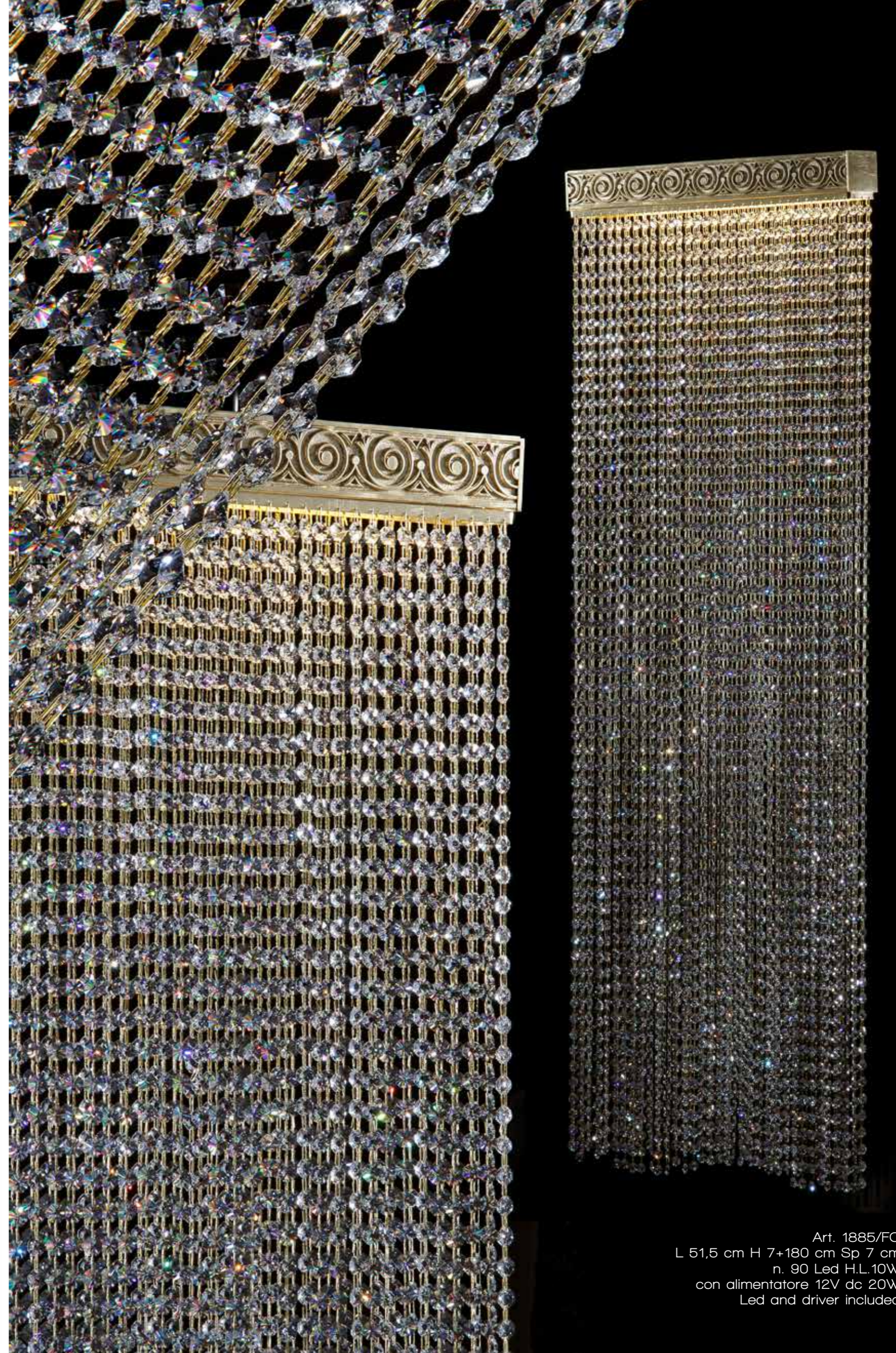

Art. 1885/FO  
L 51,5 cm H 7+180 cm Sp 7 cm  
n. 90 Led H.L.10W  
con alimentatore 12V dc 20W  
Led and driver included





Art. 2046/LU  
ø 100 mm ø int 52 mm  
ø foro per incasso 65mm  
completo di molle/with screw



Art. 2074/LU  
ø 16 cm H 8 cm  
1 x G9 x Led 10W



Art. 2075/LU  
ø 16 cm H 15 cm  
1 x G9 x Led 10W



Art. 2076/LU  
ø 16 cm H 15 cm  
1 x G9 x Led 10W

Art. 2069/LU  
ø 42 cm H 12 cm  
4 x G 9 x Led 10W





Art. 799  
Ø 42 cm  
2 x E27 x 60W



Art. 798  
Ø 32 cm  
2 x E27 x 60W



Art. 731  
Ø 32 cm  
2 x E27 x 60W



Art. 732  
Ø 42 cm  
2 x E27 x 60W



Art. 1773/P/LU  
Ø 24 cm H 17 cm  
2 x E14 x 40W

Art. 1773/G/LU  
Ø 38 cm H 24 cm  
3 x E14 x 60W





Art. 1494/A  
Ø 50 cm H 20 cm  
3 x E14 x 40W

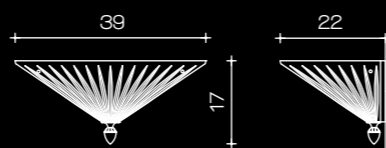

Art. 1621/B Applique  
Ø 39 cm H 17 cm  
1 x G9 x 40W

Art. 1494/B  
Ø 50 cm H 20 cm  
3 x E14 x 40W



Art. 1771/P  
Ø 41 cm H 20 cm  
2 x E14 x 40W

Art. 1771/G  
Ø 50 cm H 20 cm  
3 x E14 x 40W

Art. 1772/G  
Ø 50 cm H 20 cm  
3 x E14 x 40W

381

Il Paralume Marina





382

Art. 2172/B  
ø 44 cm H 23 cm  
8 x G9 x Led



383

Il Paratlume Marina

Art. 2172  
ø 44 cm H 82 cm  
8 x G9 x Led



Art. 1635/CH8  
H 107 cm ø 112 cm  
Pø 18 cm  
8 x E14 x 40W  
4 x E14 x 40W (interne)

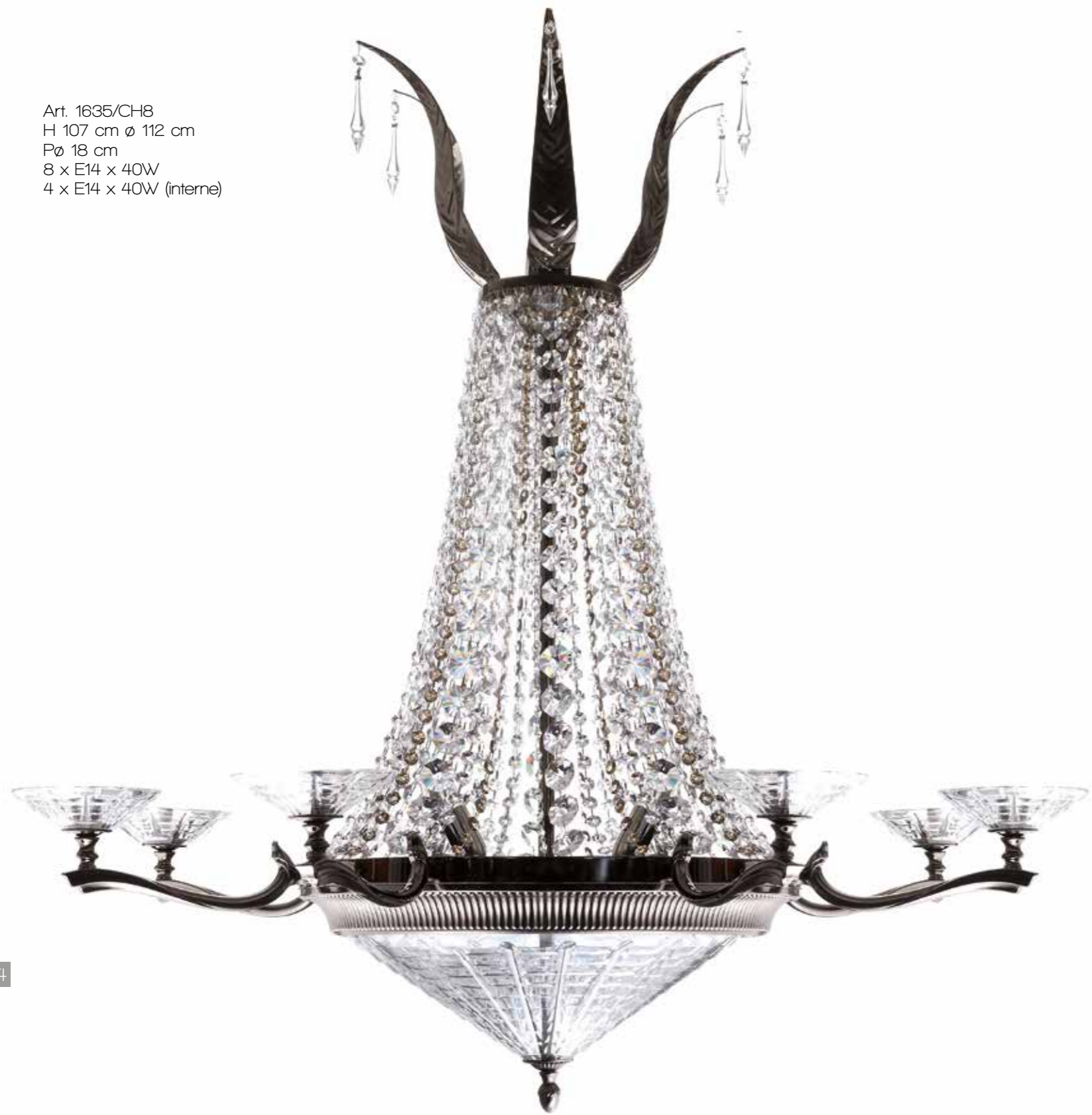

Art. 2038/CH8/KR  
ø 95 cm H 75 cm  
8 x E14 x 40W  
+3 x E14 x 5W  
LED ONLY



384

385



Art. 2007/A1/NL  
L 15 cm H 21 cm Sp 28 cm  
1 x E14 x 40W



Art. 2007/A2/NL  
H 21 cm L 41 cm Sp 23 cm  
2 x E14 x 40W



Art. 2038/A2/KR  
L 43 cm H 22 cm Sp 22 cm  
2 x E14 x 40W









Art. 908/P  
ø 19 cm profondità 29 cm  
1 x E14 x 25W



Art. 908/G  
ø 31 cm profondità 29 cm  
2 x E14 x 25W



Art. 2043/A2/AV  
L 63 cm x H 13 cm Sp 24 cm  
2 x E14 x 25W

388



Art. 2073/AV  
L 60 cm x H 11 cm Sp 27 cm  
4 x G9 x Led 10W



Art. 2043/A1/AV  
L 25 cm H 13 cm Sp 24 cm  
1 x E14 x 25W

389



Art. 490  
 L 35 cm H 12 cm  
 Sp 21 cm Pø 33 cm  
 base ovale 10x6 cm  
 2 x E14 x 25W



490

Art. 490/RP  
 L 42 cm Sp 20 cm  
 2 x E14 x 25W



Art. 490/RM  
 L 32 cm Sp 20 cm  
 2 x E14 x 25W



Art. 490/RG  
 L 22 cm Sp 20 cm  
 1 x E14 x 25W



*Faretto a parete in ottone cromato  
 e diffusore in vetro di Murano  
 trasparente soffiato a coste orizzontali.*

*Wall lamp made on krome brass and  
 trasparent Murano glass blown on  
 horizontal stripe.*

Lamp On



Lamp Off



Art. 1409  
 L 50 cm  
 Sp max 24 cm  
 2 x E14 x 25W

Art. 1409/A  
 H 50 cm Sp 9 cm  
 2 x E14 x 25W





5 Led Luce bianco caldo  
3150°K 86 Lm/W Consumo 1 W per Led



Art. 1492/A  
L 31 cm H 36 cm  
Sp 32 cm / Led



Art. 1454  
L 31 cm H 12 cm  
Sp 24 cm / Led



Art. 1453  
L 31 cm H 16 cm  
Sp 24 cm / Led



Art. 1492  
L 31 cm  
H 35 cm / Led



Art. 1463  
L 60 cm  
H 180 cm  
4 x G9x Led 10W



Art. 1466  
H 190 cm

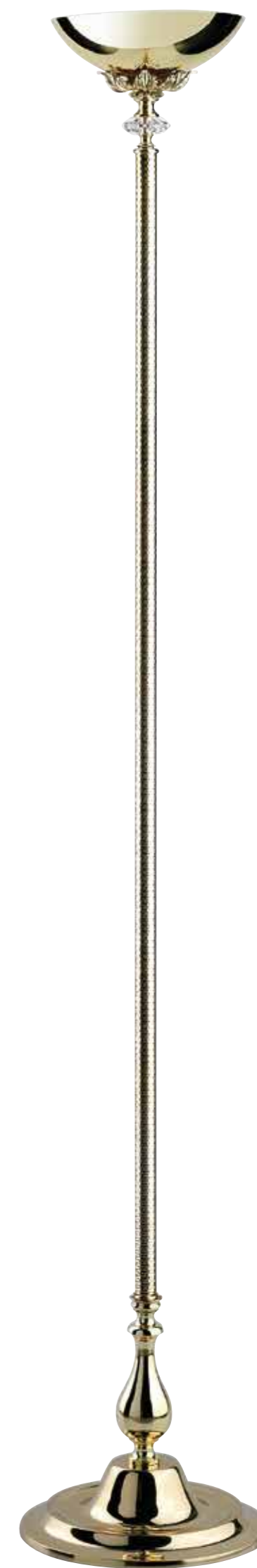

Art. 1465  
ø 22 cm  
H 180 cm  
1 alogena 300W



N. 19

N. 20

N. 21

N. 22

N. 23

N. 24

N. 25

N. 26

N. 27

N. 28

N. 31

N. 32

N. 33  
L 20 cm  
ø 5 cm

N. 35  
L 19 cm  
ø 4 cm



394

395



N. 34  
L 47 cm  
Ø 6 cm

N. 38  
L 70 cm  
Ø 6,5 cm

N. 39  
L 40 cm  
Ø 3 cm

N. 10

N. 16

N. 17/1

N. 15

N. 12

N. 13

N. 14

N. 16

N. 18





# Nappe

Strass oro

Strass bianco/oro

Strass marrone/oro

Strass blu/oro

Fascetta oro

Pon-Pon

Oro semplice

Argento

Verde





Bordo 1



Bordo 2



Bordo 3



Bordo 4



Bordo 5



Bordo 6



Bordo 7



Bordo 8



Bordo 9



Bordo 10



Bordo 11



Bordo 12



Bordo 14



Bordo 15



Bordo 16



Bordo 17



Bordo 18



Bordo 19



Bordo 20



Bordo 22



Bordo 23



Bordo 24



Bordo 25



Bordo 26



Bordo 27



Bordo 28



Bordo 29



Bordo 31



Bordo 32



Bordo 33



Bordo 34





# Bordi

Bordo 35 H 6 cm



Bordo 38 H 1 cm



Bordo 39 H 2,5 cm



Bordo 40 H 0,8 cm



Bordo 41 H 1,5 cm



Bordo 42 H 0,8 cm



Bordo 43 H 0,8 cm



Bordo 44 H 1,1 cm



Bordo 45 H 0,3 cm



Bordo 46 H 0,5 cm



Bordo 50 H 0,3 cm



Bordo 51 H 0,3 cm



Bordo 52 H 0,8 cm



Bordo 56 H 4 cm



Bordo 57 H 0,8 cm



Bordo 58 H 0,6 cm



Bordo 59 H 6 cm



Bordo 60 H 5 cm



Bordo 61 H 5 cm



Bordo 62 H 4 cm



Bordo 63 H 5 cm



Bordo 64 H 3,5 cm



Bordo 65 H 4 cm



Bordo 67 H 13 cm



Bordo 68 H 6 cm





# Bordi

Bordo 76 H 2 cm



Bordo 77 H 2 cm



Bordo 78 H 2 cm



Bordo 79 H 2 cm



Bordo 80 H 1 cm



Bordo 81 H 1,2 cm



Bordo 82 H 3 cm



Bordo 84 H 0,7 cm



Bordo 85 H 0,6 cm



Bordo 86 H 1,3 cm



Bordo 87 H 4,5 cm

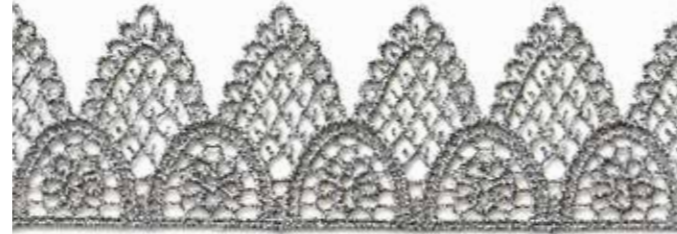

Bordo 88 H 6 cm



Bordo 89 H 3 cm



Bordo 93 H 3,4 cm



Bordo 94 H 5 cm



Bordo 95 H 5 cm



Bordo 96 H 5 cm



Bordo 97 H 5 cm



Bordo 98 H 4 cm



Bordo 100 H 0,8 cm



Bordo 101 H 0,5 cm



Bordo 102 H 0,5 cm



Bordo 104 H 3,8 cm



Bordo 105 H 4,5 cm



Bordo 106 H 2 cm





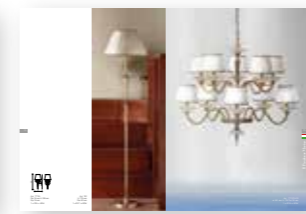
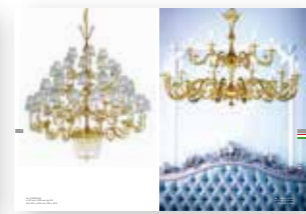

2

4

6

8

70

72

74

76

78

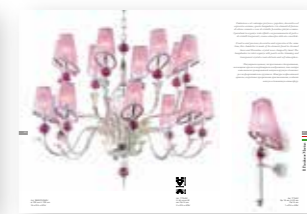
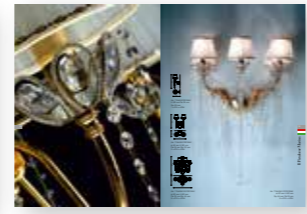

10

12

14

16

18

80

82

84

86

88



20

22

24

26

28

90

92

94

96

98



30

32

34

36

38

100

102

104

106

108



40

42

44

46

48

110

112

114

116

118

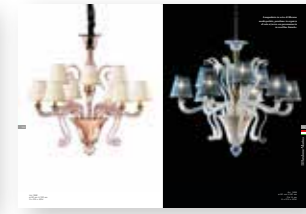

50

52

54

56

58

120

122

124

126

128



60

62

64

66

68

130

132

134

136

138





140



142



144



146



148



210



212



214

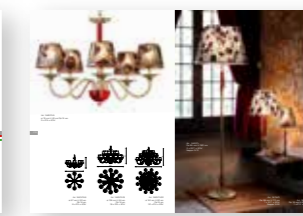

216



218

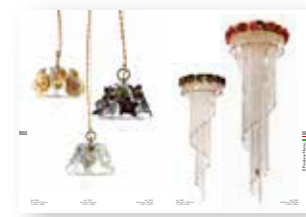

150



152



154



156

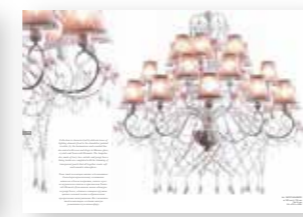

158



220



222



224



226



228



160



162



164



166

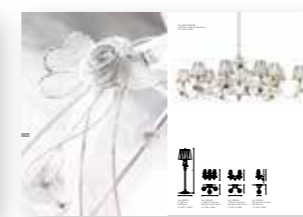

168

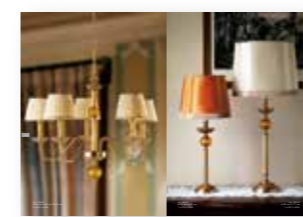

230



232



234



Table Lamps



236



170



172



174

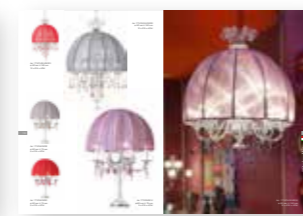

176



178



238



240



242



244



246



180



182



184



186

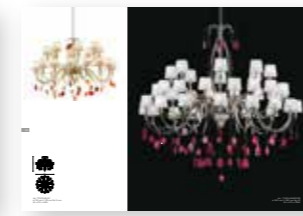

188



248



250



252



254



256



190

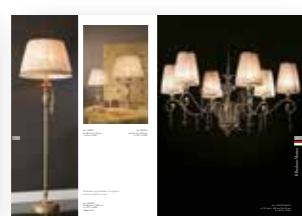

192



194

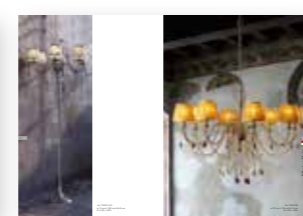

196

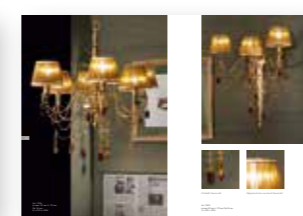

198

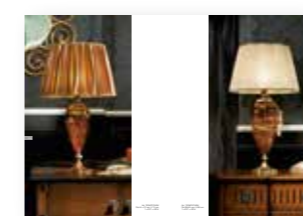

258



260



262

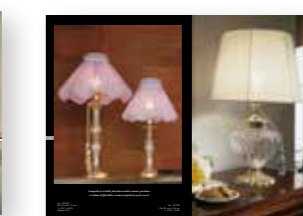

264



266



200



202

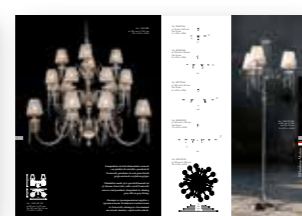

204

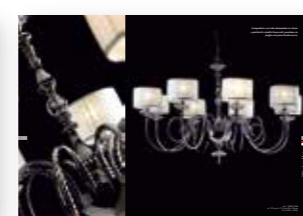

206



208



268



270



272

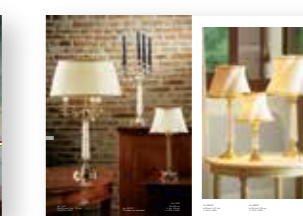

274



276





278

280

282

284

286



288

290

292

294

296



298

300

302

304

306



308

310

312

314

316



Appliques

318

320

322

324



326

328

330

332

334

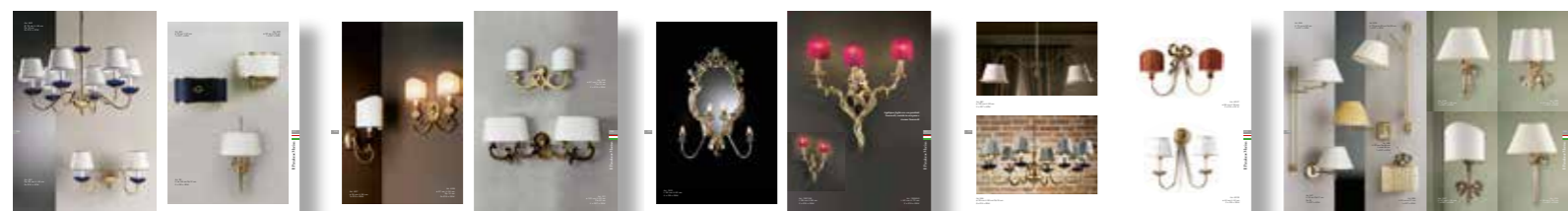

336

338

340

342

344

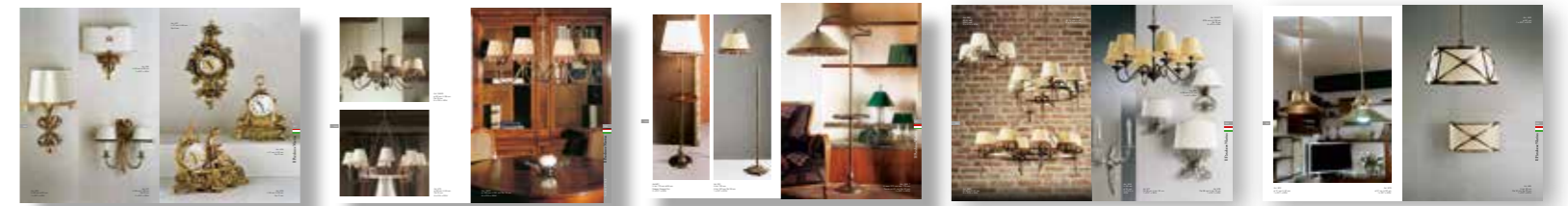

346

348

350

352

354

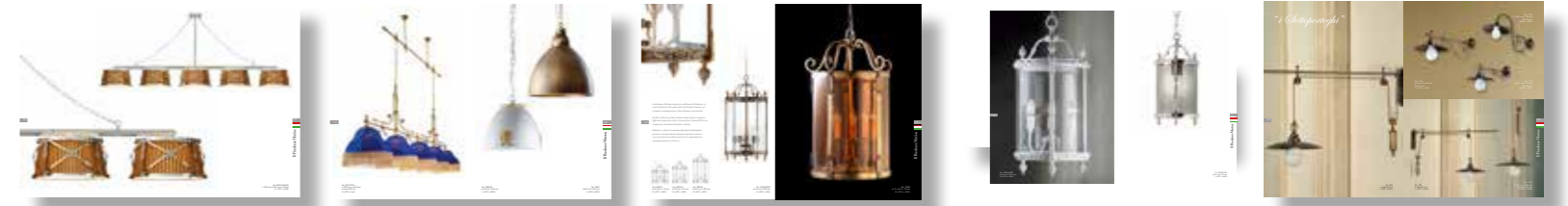

356

358

360

362

364



Spotlights

366

368

370

372



374

376

378

380

382

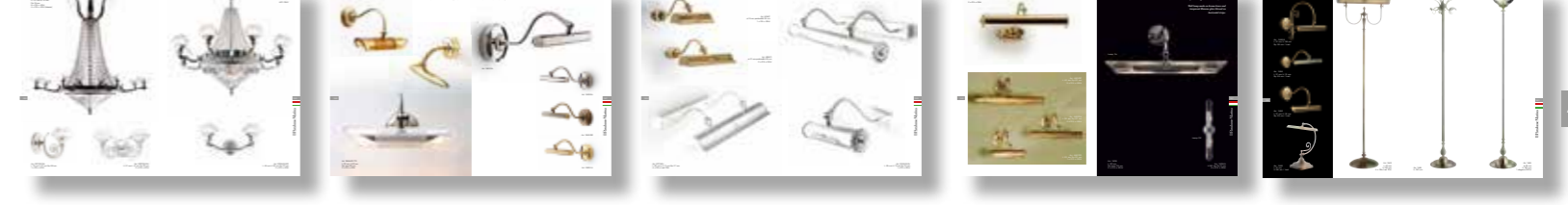

384

386

388

390

392

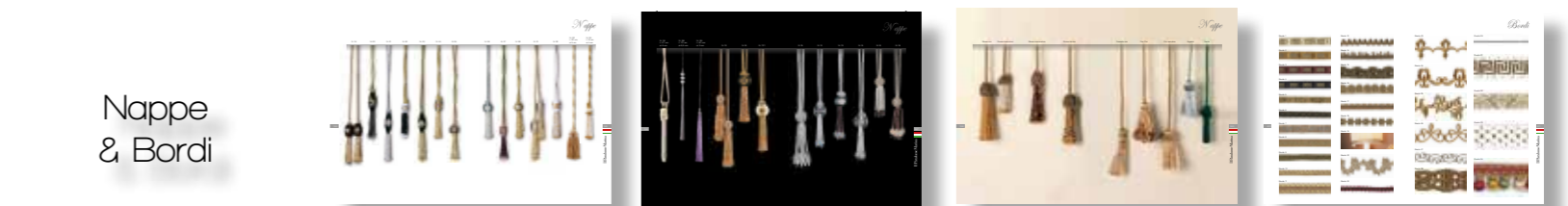

Nappe & Bordi

394

396

398

400



402

404

412

414

410

411





SWAROVSKI® e un marchio registrato



Atelier del Paralume  
Atelier lampshades  
Ателье абажуров



Fusione in Ottone  
Brass casting  
Литье латуни



Vetro di Murano  
Murano glass  
Муранское стекло



Cristallo Italiano  
Italian Crystal  
Итальянский хрусталь

# Il Paralume Marina

La Passione, la dedizione e la cura attentissima del dettaglio, animano l'atelier della Signora Marina. Moderne tecnologie affiancano lavorazioni manuali tradizionali per ottenere un prodotto totalmente esclusivo e di eccellenza, 100% Made in Italy. La continua ricerca e innovazione di tessuti e passamanerie rende Il Paralume Marina Leader nel creare oggetti su misura.

*Passion, dedication and careful attention to detail bring to life the workshop of Mrs. Marina. Modern technologies alongside traditional manual processes obtain a product totally unique and of high quality, 100% Made in Italy. The continuous research and innovation of fabrics and trimmings makes Il Paralume Marina, the Leader in creating custom-made products.*

В ателье госпожи Марины царят Вдохновение, Страсть, Самоотдача и высочайшее Внимание к деталям. Современные технологии идут рука об руку с традиционными техниками рукоделия, воплощаясь в эксклюзивном продукте, 100% сделанном в Италии. Постоянные исследования и применения последних инноваций в тканях и окантовках делают Il Paralume Marina лидером среди производителей персонализированных изделий.

La fusione in terra dell'ottone è un'arte antica, che ancora oggi sa emozionare. La pressofusione crea oggetti di eccellenza e di altissima qualità sinonimi di lusso ed eleganza esclusivamente made in Italy. Fondiamo metallo trasformando l'idea di architetti e designer in oggetti esclusivi, dal prototipo allo stampo, al prodotto finito.

*Brass sand casting is an ancient art, which still continues to excite. Casting creates objects of excellence and of the highest quality, demonstrating luxury and elegance exclusively made in Italy. We base metal transformation on the ideas of exclusive product architects and designers, from the prototype, to the mould, to the finished product.*

Литье латуни «в землю» - это античное искусство, которое и сегодня способно вызывать эмоции. Литье создает предметы высокого качества с особым благородным шармом, присущим роскошным интерьерам, сделанным исключительно в Италии. Мы плавим металл, трансформируя идею архитектора и дизайнера в эксклюзивные предметы: от прототипа - к штампу - до законченного продукта

Maestri artigiani che tramandano l'arte antica muranese garantiscono un prodotto di classe di alta gamma e qualità indiscutibili. La produzione interamente artigianale e l'uso di tecniche raffinate rendono ogni oggetto un pezzo unico. L'esperienza dei maestri per noi è un punto di partenza per creare oggetti attuali di arredamento e di emozione. La forza del Paralume Marina è la qualità eccellente e la flessibilità nell'assecondare le richieste di un mercato internazionale sempre in evoluzione.

*Master craftsmen who hand down the ancient art of Murano guarantee a high-class product of unquestionable quality. Total handmade production and the use of sophisticated techniques make each product unique. The experience of the master craftsmen is a starting point for us to create real pieces of furniture of emotion. The strength of Il Paralume Marina is the excellent quality and flexibility to adapt to the demands of an ever changing market.*

Мастера-ремесленники передают античное искусство муранского стекла из поколения в поколение, что гарантирует их изделиям высочайший уровень качества. Изготовление вручную и использование искусственных техник делают каждое их творение уникальным и неповторимым. Опыт Мастеров является для нас отправной точкой для создания актуальных предметов интерьера с ярким эмоциональным оттенком. Сильной стороной Il Paralume Marina является безупречное качество и гибкость в подходе к требованиям динамичного и такого разнообразного международного рынка.

Il cristallo è orgogliosamente solo italiano. Si ottiene fondendo in appositi forni a temperatura elevata, superiore a 1400°, utilizzando materie prime di qualità superiore si ottiene un prodotto con oltre il 24% di PbO, che conferisce una luminosità e trasparenza indiscutibili. La lavorazione del cristallo è eseguita artigianalmente; viene soffiato a bocca e le incisioni sono eseguite interamente a mano per cui ogni oggetto diviene "Objet d'Arte".

*Paralume Marina proudly uses only Italian crystal. It is made by melting in special high temperature furnaces, exceeding 1400°, using optimum quality raw materials a product is obtained with over 24% of PbO, which gives an undeniable brightness and clarity. The processing of crystal is carried out by hand; it is blown and the incisions are made entirely by hand so that every object becomes an "Objet d'art".*

Исключительно лучший итальянский хрусталь является нашей гордостью и отличительной чертой. Его получают посредством плавки в специальных печах при высокой температуре, превышающей 1400°, используя материалы лучшего качества. Это позволяет получить продукт с процентом свинца в составе в 24% и выше, что придает изделиям безупречную прозрачность и яркость. Обработка хрусталя проходит вручную: его выдувают, а затем гравировать полностью вручную, что гарантирует каждому изделию титул Произведения Искусства.







## Project

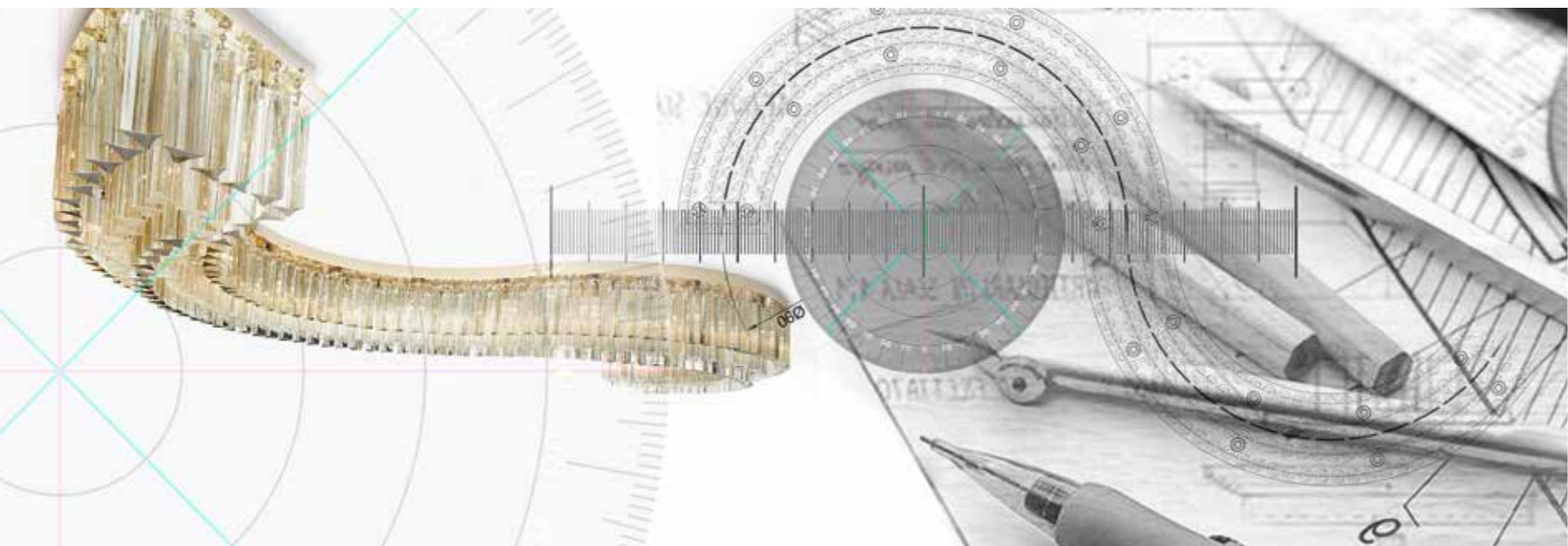

Ogni progetto è una sfida che affrontiamo con serietà e passione, dedizione al cliente e cura nei dettagli maniacale. Il Paralume Marina con la sua esperienza e con il suo team interno di designer e ingegneri, garantisce un servizio esclusivo ai professionisti che desiderano utilizzare soluzioni di illuminazione decorativa nei loro progetti, proponendo alternative stilistiche, tecniche ed economiche adeguate alla richieste della committenza.

*Each project is a challenge that we approach with seriousness and passion, dedication to the customer and meticulous attention to detail. Il Paralume Marina with its experience and in-house team of designers and engineers, guarantees an exclusive service for users who wish to use decorative lighting solutions in their projects, offering stylistic, technical and inexpensive options adapted to the demand of the client.*

Каждый проект – это вызов, который мы принимаем с максимальной серьезностью и страстью, преданностью клиенту и маниакальным вниманием к деталям. Il Paralume Marina со своим опытом и собственной сплоченной командой дизайнеров и инженеров, гарантирует эксклюзивный сервис для профессионалов, которые желают включить в собственные проекты смелые решения по декоративному освещению, предлагая стилистические, технические и экономические альтернативы, оптимально адаптированные под запрос Заказчика.

# Il Paralume Marina

Classic Lighting

Design: Arch. Federica Vicentini  
Proget Director: Thomas Simoncello  
Printing: Girardi Print Factory

Tutte le misure sono indicate in cm  
H = altezza, L = larghezza,  
∅ = diametro, P∅ = diametro del paralume,  
Sp = sporgenza.

Tutti i diritti riservati.  
Sono vietate la pubblicazione la trasmissione la fotocopiatura e qualsiasi altra forma di duplicazione o riproduzione, parziali e totali dei testi e della grafica qui contenuti, senza il preventivo consenso scritto della ditta il Paralume Marina. Il produttore si riserva il diritto di introdurre modifiche tecnologiche. Il produttore declina qualsiasi responsabilità per eventuali errori di stampa.

Il Paralume Marina s.r.l.  
Vicolo Col Beretta, 6  
36022 San Zeno di Cassola (VI) ITALY

Tel +39 0424 33 042  
Fax +39 0424 511 817

www.ilparalumemarina.com  
info@ilparalumemarina.it  
Skype: ilparalumemarina

*Made in Italy*  
Since 1987



# Il Paralume Marina



MADE IN ITALY  
Since 1987

[ilparalumemarina.it](http://ilparalumemarina.it)