



CONTEMPORARY 2019

IPM light

Il Paralume Marina

Contemporary Lighting

About us

La storia dell'azienda IL PARALUME MARINA nasce nel 1987 quando i coniugi Ferronato-Simoncello hanno fondato la loro piccola azienda familiare basata sulla comune passione per l'illuminazione decorativa. Negli anni seguire i figli Thomas e Simone hanno dato ulteriore impulso rispettivamente all'internazionalizzazione commerciale del prodotto in tutto il mondo ed ad un alto livello tecnico-progettuale degli stessi corpi illuminanti. Negli anni a seguire il loro lavoro ha elevato il marchio PARALUME MARINA ad un firma internazionale e questo brand è diventato sinonimo di dedizione e creatività combinate ad un eccellente grado di qualità artigianale esclusivamente Made in Italy. La produzione è basata su antiche tecniche di fusione dell'ottone, dal cristallo italiano, dalla soffiatura del vetro di Murano e dallo stile unico dei paralumi cuciti a mano dall'atelier della signora Marina. Il cristallo autentico Swarovski completa la scintillante brillantezza di questi pezzi unici. Ogni creazione è fatta a mano secondo le esigenze del cliente. Il Paralume Marina è specializzato nella produzione di pezzi su misura secondo i desideri del cliente e offre un ampio raggio di tessuti, passamanerie, finiture di ottone e di colori di vetro e cristallo da cui attingere. Questo dà l'opportunità al cliente di scegliere qualcosa di unico ed irripetibile creato esclusivamente da lui e per lui. Gli architetti e i designers de IL PARALUME MARINA sono disponibili a creare la giusta collezione per ogni interior a cominciare dai lampadari, a proseguire con spot ad incasso, bastoni tenda e accessori da bagno. Siamo orgogliosi di poter soddisfare qualsiasi richiesta sia per gli interni di case private sia per prestigiosi hotel. Potete ammirare i nostri progetti di illuminazione in tutto il mondo.

The story of the company IL PARALUME MARINA has started in 1987 when the spouses Ferronato-Simoncello have founded their small family-run business based on the common passion for decorative ITALIAN lighting. In the followings years their sons Thomas and Simone have given further drive, respectively in internationally marketing the products all over the world and at high technical design levels of lights themselves. In 30 successful years their hard work have brought "Il Paralume Marina" an international fame and this brand has become a representation of commitment and creativity combined with high Made in Italy craftsmanship quality. Its production is based on the antique techniques of brass fusion, blowing of the Murano glass and Italian Crystal and unique recognizable style of the handsewn lampshades from Mrs. Marina. The authentic Swarovski crystals complement the sparkling beauty of the manufactures. Every item is created by hand and with consideration of every client's wish. IL PARALUME MARINA is specialized in producing of customized articles and always offers the wide range of various fabrics, trimmings, tassels, brass, crystal and glass colours to choose from. This way we give the Client opportunity to create every time something special and unrepeatable, something that He can call His own, made exclusively for Him. The architects and designers of Il Paralume Marina are ready to create the whole collection for any ambience starting with chandeliers and finishing with spotlights, bathroom accessories and curtain rods. We are able to satisfy any request, whether it is a private house or a luxury hotel. In fact on the list of projects completed there are numerous top-rate hotels and residences, villas and castles throughout the world.

История компании IL PARALUME MARINA началась в 1987 году, когда супруги Ферронато-Симончелло основали свой маленький семейный бизнес, движимые общей любовью к декоративному освещению. Годы спустя их традицию не только продолжили, но и развили сыновья Томас и Симоне, каждый из которых внес свой вклад в развитие компании как в международном маркетинге, так и в высокотехнологичном дизайне светильников. 30 лет тяжелой, но успешной работы принесли IL PARALUME MARINA международную славу и сегодня этот бренд ассоциируется с креативностью и самоотдачей, обремененной с высочайшим качеством продукта, сделанного в Италии. Производство основано на старинных технологиях литья латуни, выдувания муранского стекла и флорентийского хрусталя и, конечно же, на уникальном и узнаваемом стиле шитых вручную абажуров от г-жи Марины. Сияющую красоту изделий дополняют подлинными кристаллы Swarovski. Каждое изделие создано строго вручную, с учетом всех пожеланий заказчика.

IL PARALUME MARINA специализируется на производстве персонализированных изделий и всегда предлагает широкий спектр тканей, кантов, кистей, большой выбор отделок металла, хрусталя и муранского стекла. Это позволяет Заказчику каждый раз создавать что-нибудь особенное и неповторимое, что он может назвать Своим, сделанным специально для Него. Архитекторы и дизайнеры IL PARALUME MARINA готовы создать полную коллекцию для любого помещения, начиная от люстр и заканчивая встроенными светильниками, аксессуарами для ванных комнат, а также карнизами. Мы способны удовлетворить любой запрос, будь-то частный дом или роскошный отель, о чем свидетельствуют снимки завершенных проектов, среди которых топ-рейтинговые гостиницы и резиденции, виллы и замки по всему миру.

Made in Italy

Since 1987

Organic

Anello in soft gold con decorazioni in vetro.

Ring in soft gold finish with glass decorations.

Круг в цвете "светлое золото" с украшениями из стекла.



Art. 2178/CH8
Ø max 138 cm H 25 cm
+100 cm Steel cable
8 x G9 x Led



Organic

Anello in oro pallido con decorazioni in vetro.

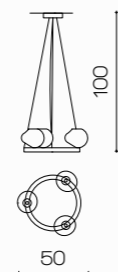

Art. 2178/CH4
 Ø max 90 cm H 25 cm
 +100 cm Steel cable
 4 x G9 x Led

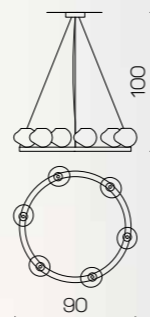

Art. 2179/CH3
 Ø max 50 cm H 17 cm
 +83 cm Steel cable
 3 x G9 x Led

Art. 2179/CH6
 Ø max 90 cm H 17 cm
 +83 cm Steel cable
 6 x G9 x Led



Art. 2179/CH8
 Ø max 130 cm H 17 cm
 +83 cm Steel cable
 8 x G9 x Led



Ring in soft gold finish with glass decorations.

Круг в цвете "светлое золото"
 с украшениями из стекла.

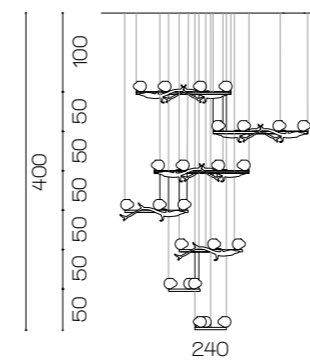

Art. 2178/CH38
 L 240 x 138 cm H 400 cm
 38 x G9 x Led

Art. 2178/CH8
 Ø max 138 cm H 25 cm
 +100 cm Steel cable
 8 x G9 x Led

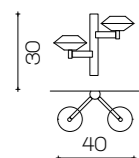

Art. 2129/A2/SG
 ø 40 cm H 30 cm Sp 23 cm
 2 x G9 x Led 10W

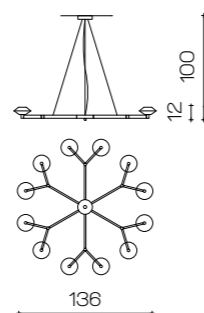

Art. 2129/CH12/SG
 ø 136 cm H 12 cm H tot. 100 cm
 12 x G9 x Led 10W

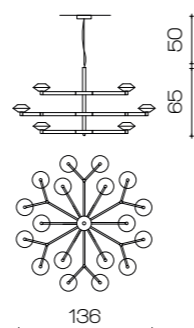

Art. 2129/CH24/SG
 ø 136 cm H 65 cm
 24 x G9 x Led 10W

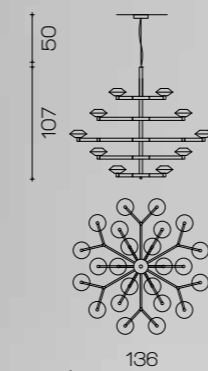

Art. 2129/CH36/SG
 ø 136 cm H 107 cm
 36 x G9 x Led 10W





Art. 2127/CH24/NL
 ø 132 cm H 65 cm
 Pø 14 cm
 24 x E14 x Led 5W

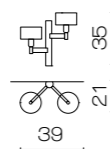

Art. 2127/A2
 L 39 cm H 35 cm
 Pø 14 cm Sp 21 cm
 2 x E14 x Led

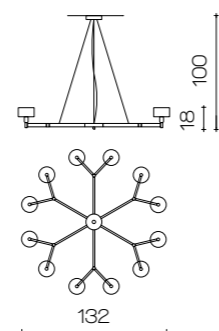

Art. 2127/CH12
 ø 132 cm H 18 cm
 H tot. 100 cm Pø 14 cm
 12 x E14 x Led

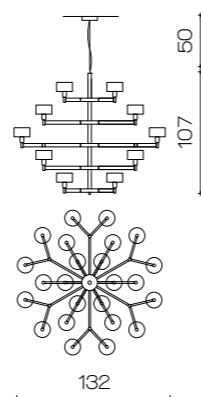

Art. 2127/CH36
 ø 132 cm H 107 cm
 Pø 14 cm
 36 x E14 x Led

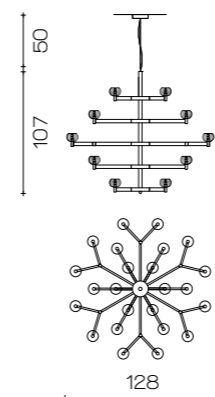

Art. 2130/CH36
 ø 128 cm
 H 107 cm
 36 x G9 x Led 10W

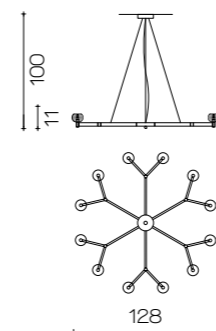

Art. 2130/CH12
 ø 128 cm H 11 cm
 H tot. 100 cm
 12 x G9 x Led 10W

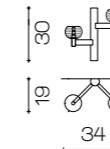

Art. 2130/A2
 L 34 cm H 30 cm
 Sp 19 cm
 2 x G9 x Led

Art. 2130/CH24/NL
 ø 128 cm H 65 cm
 24 x G9 x Led 10W



Art. 2121/LU
L 147 cm H 93 cm Sp 10 cm
Led 3000 K° 4400 Lumen



Art. 2122
L 28 cm H 40 cm Sp 10 cm
Led 3000 K° 1700 Lumen

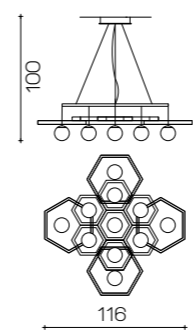

Art. 2123/CH11/LU
Ø 116 cm H tot. 100 cm
11 x G9 x Led 10W

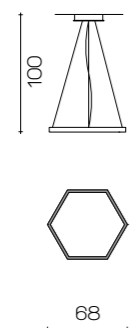

Art. 2125
L 68 cm H tot. 100 cm
Led 3000 K° 1500 Lumen

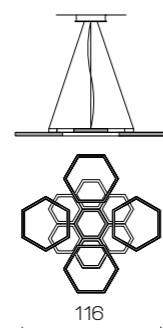

Art. 2124/LU
ø 116 cm H tot. 100 cm
Led 3000 K° 7000 Lumen

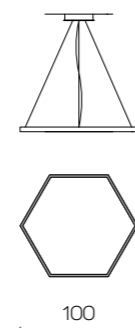

Art. 2126
L 100 cm H tot. 100 cm
Led 3000 K° 3100 Lumen



Art. 2124/NL
ø 116 cm H tot. 100 cm
Led 3000 K° 7000 Lumen



Art. 2173/CH18+18
 ø 124 cm H 100 cm
 36 x G9 x Led



Art. 2173/A1+1
 L 10 cm H 43 cm
 Sp 12 cm
 2 x G9 x Led

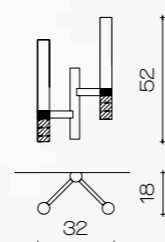

Art. 2173/A2+2
 L 32 cm H 52 cm Sp 18 cm
 4 x G9 x Led

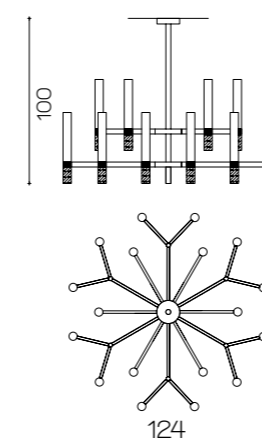

Art. 2173/CH18+18
 ø 124 cm H 100 cm
 36 x G9 x Led

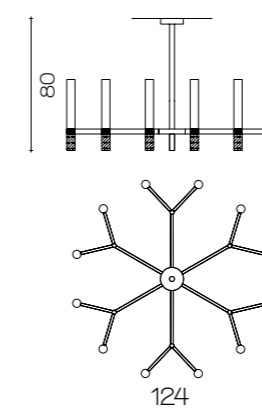

Art. 2173/CH12+12
 ø 124 cm H 80 cm
 24 x G9 x Led

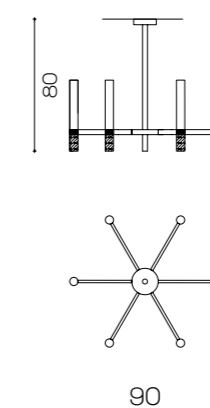

Art. 2173/CH6+6
 ø 90 cm H 80 cm
 12 x G9 x Led

Marble

Lampadario con elementi di marmo di Carrara e vetro, una combinazione esclusiva che crea atmosfere uniche.

Chandelier with elements in Carrara marble and glass, an exclusive combination that creates unique atmospheres.

Люстра с элементами из каррарского мрамора и стекла - уникальное сочетание, создающее неповторимую атмосферу.



16

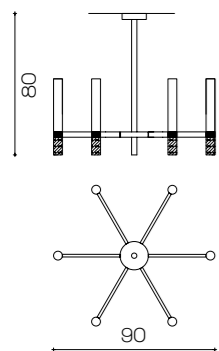

Art. 2173/CH6+6
ø 90 cm H 80 cm
12 x G9 x Led



17

Il Paralume Marina

Art. 2185
ø 30 cm H 33 cm
1 x E14 x Led

*Desk Table lamp in
Carrara Marble.*



18

Art. 2184
L 36 x 19 cm H 38 cm
1 x E27 x Led



19

Il Paralume Marina

Art. 2184
L 36 x 19 cm H 38 cm
1 x E27 x Led

Art. 2201/P/Black
L 28 cm ø 28 cm Sp 12 cm
1 x G9 x Led



Art. 2176/P/white
L 28 cm ø 28 cm Sp 12 cm
1 x G9 x Led



Art. 2176/G/white
L 40 cm ø 40 cm Sp 14 cm
1 x G9 x Led

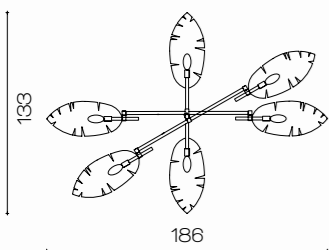

Art. 2158/CH6
L 186 x 133 cm H 90 cm
6 x E14 x Led

Leaf

Corpi illuminanti con foglie stilizzate finite esternamente in oro pallido spazzolato e internamente lucido, su struttura metallica in nero opaco ed elementi in Marmo di Carrara.

Leaf

Light Fixtures decorated with stylized leaves in brushed Soft gold outside and polished finish inside on matt black metal structure and elements in Carrara marble.

Осветительные приборы из матового черного металла в каррарском мраморе, украшенные стилизованными листьями в блестящей отделке «светлое золото» изнутри и сатинированной снаружи.



Art. 2158/FL
L 22 cm H 180 cm
1 x E14 x Led

Art. 2158/FLP
L 22 cm H 150 cm
1 x E14 x Led

Art. 2158/CH6
L 186 x 133 cm H 90 cm
6 x E14 x Led



Leaf

Light Fixtures decorated with stylized banana leaves in brushed Soft gold outside and polished finish inside on matt black metal structure and elements in Carrara marble.

Осветительные приборы из матового черного металла в каррарском мраморе, украшенные стилизованными листьями в блестящей отделке «светлое золото» изнутри и сатинированной снаружи.

Art. 2158/A
L 22 cm H 68 cm Sp 19 cm
1 x E14 x Led



Art. 2159/A
L 22 cm H 68 cm Sp 19 cm
1 x E14 x Led

Art. 2158/T
L 22 cm H 65 cm
1 x E14 x Led



Art. 2170/CH11
 L 120 x 30 cm H 19 cm
 +100 steel cable
 11 x G9 x Led



28



Art. 2170/T
 L 40 x 20 cm H 62 cm
 1 x E27 x Led

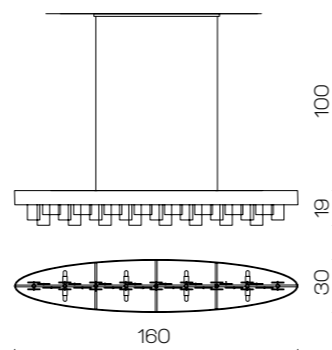

Art. 2170/CH17
 L 160 x 30 cm H 19 cm
 +100 steel cable
 17 x G9 x Led



Art. 2170/A/dx
 L 19 cm H 40 cm Sp 8 cm
 2x G9 x Led

Quarzo

Nastro ovale in metallo con preziosissimi tasselli in Quarzo che filtrano e creano suggestioni di luce.

Oval metal tape with precious quartz plugs that filter light and create wonderful light effects.

Овальная лента из металла украшена ценными кварцевыми вставками, которые создают невероятный эффект игры со светом.

29



Corpi illuminanti in finitura oro pallido e sfere in cristallo italiano molato a mano.

Light fixtures in soft gold finish with hand-cut Italian crystal spheres.

Светильники в отделке «светлое золото» с хрустальными шарами ручной гравировки.

Art. 2164/A
L 12 cm H 46 cm Sp 14 cm
1 x G9 x Led



Art. 2177/CH16
ø 112 cm H 15 cm
+100 cm Steel cable
16 x G9 x Led +3 GU10 Led

Cactus

Corpi illuminanti in finitura oro pallido e sfere in cristallo italiano molato a mano.

Light fixtures in soft gold finish with hand-cut Italian crystal spheres.

Светильники в отделке «светлое золото» с хрустальными шарами ручной гравировки.



32

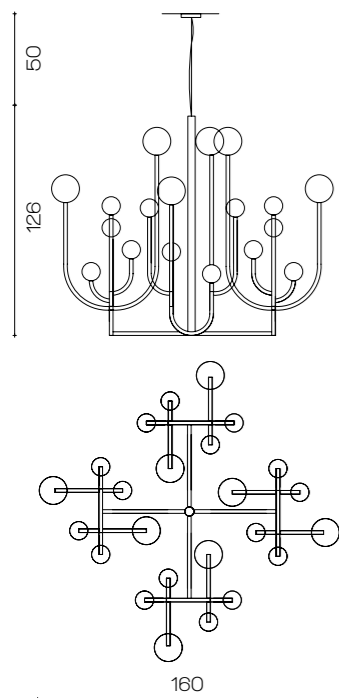

Art. 2163/CH24
Ø 160 cm H 126 cm
+50 cm steel cable
24 x G9 x Led

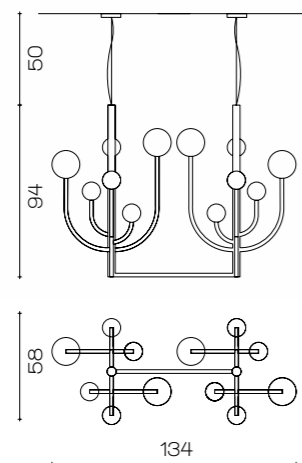

Art. 2163/CH12
L 134 x 58 cm H 94 cm
+50 cm steel cable
12 x G9 x Led

33

Il Paralume Marina

Cactus

Corpi illuminanti in finitura oro pallido e sfere in cristallo italiano molato a mano.

Light fixtures in soft gold finish with hand-cut Italian crystal spheres.

Светильники в отделке «светлое золото» с хрустальными шарами ручной гравировки.



2164/T
L 28 x 20 cm H 64 cm
2 x G9 x Led

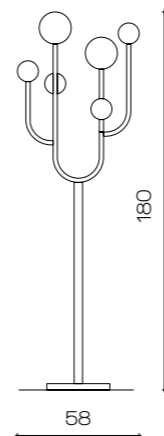

Art. 2164/FL
L 58 x 65 cm H 180 cm
6 x G9 x Led

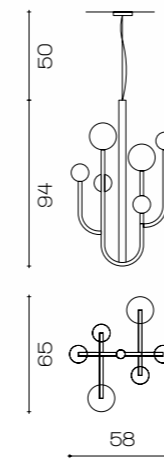

Art. 2164/CH6
L 65 x 58 cm H 94 cm
+50 cm steel cable
6 x G9 x Led



Art. 2056/FL/OV
L 35 x 25 cm H 178 cm
3 x G9 x 5W Led



Art. 2056/CH12/OV
L 152 cm x 90 cm H 90 cm
Metal base: 100 x 22 cm
+50 cm steel cable
12 x G9 x 5W Led



Art. 2056/CH12/OV
L 152 x 90 cm H 90 cm
Metal base: 100x22 cm +50 cm steel cable
12 x G9 x 5W Led





Art. 2056/A1
L 25 cm H 58 cm
Sp 16 cm
1 x G9 x 5W Led



Art. 2056/T/OV
L 31 x 12 cm H 63 cm
2 x G9 x 5W Led



Art. 2115/CH16/SG
L 205 cm x 50 cm x H 80 cm
16 x E14 x 25W



Art. 2115/FL/SG
L 46 cm H 192 cm
2 x E14 x 25W



Art. 2115/A1/SG
L 18 cm Sp 25 cm H 90 cm
1 x E14 x 25W



Art. 1946/CH8/LU
 ø 93 cm H 68 cm
 8 x E14 x 40W

Art. 1946/CH8/NL
 ø 93 cm H 68 cm
 8 x E14 x 40W

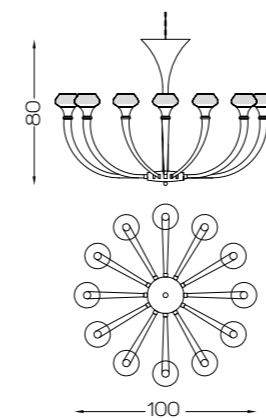

Art. 1946/CH12/NL
 ø 100 cm H 80 cm
 12 x E14 x 40W

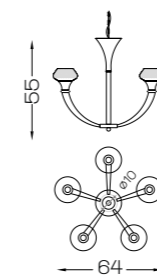

Art. 1946/CH5/NL
 ø 64 cm H 55 cm
 5 x E14 x 40W

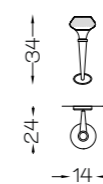

Art. 1946/A1/NL
 L 14 cm H 34 cm Sp 24 cm
 1 x E14 x 40W



Art. 1946/A2/NL
L 40 cm H 32 cm Sp 20 cm
2 x E14 x 40W

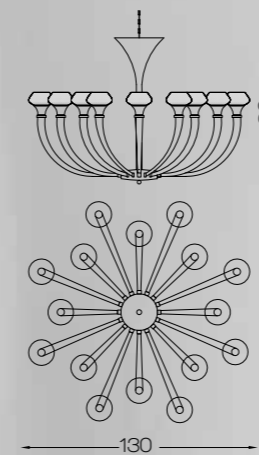

Art. 1946/CH16/LU
ø 130 cm H 80 cm
16 x E14 x 40W



Art. 2072/CH12/BI
 ø 66 cm H 128 cm
 +50 cm steel cable
 12 x G9 x Led 10W

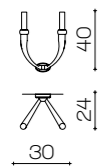

Art. 2071/A2/BI
 L 30 cm H 40 cm
 Sp 24 cm
 2 x G9 x Led 10W

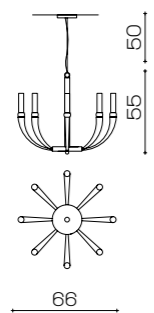

Art. 2071/CH8/BI
 ø 66 cm H 55 cm
 +50 cm steel cable
 8 x G9 x Led 10W

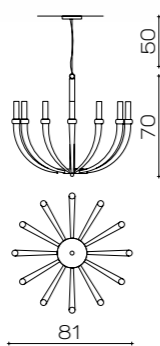

Art. 2071/CH12/BI
 ø 81 cm H 70 cm
 +50 cm steel cable
 12 x G9 x Led 10W

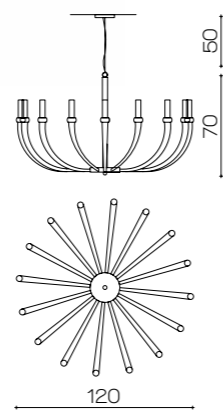

Art. 2071/CH16/BI
 ø 120 cm H 70 cm
 +50 cm steel cable
 16 x G9 x Led 10W

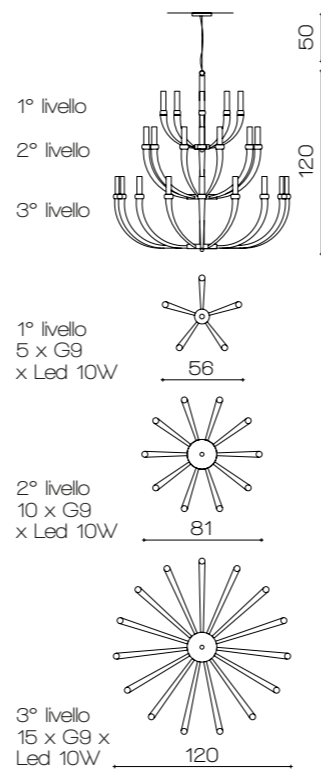

Art. 2071/CH30/BI
 ø 120 cm H 70 cm
 +50 cm steel cable
 30 x G9 x Led 10W

Art. 2071/CH15/BI
 ø 81 cm H 92 cm
 +50 cm steel cable
 15 x G9 x Led 10W





Art. 1946/NL/AZ
Pø 34 cm H 104 cm
1 x E27 x 60W
1 x G9 x 25W

Design: Arch. Federica Vicentini



Art. 1946/NL/AM
Pø 34 cm H 104 cm
1 x E27 x 60W
1 x G9 x 25W

Art. 1946/NL/AZ
Pø 34 cm H 104 cm
1 x E27 x 60W
1 x G9 x 25W

Art. 1946/NL/TR
Pø 34 cm H 104 cm
1 x E27 x 60W
1 x G9 x 25W

Art. 1946/NL/VE
Pø 34 cm H 104 cm
1 x E27 x 60W
1 x G9 x 25W



50

Art. 2049/CH18/LU
ø 110 cm H 150 cm
18 x G9 x Led 10W

design:
Arch. Federica Vicentini



51

Il Paralume Marina

Art. 2049/CH48/SG
ø 160 cm H 247 cm
48 x G9 x Led 10W





Sinuous and elegant honey Murano glass horns imbue luxury and lightness to this collection of chandeliers. Sophisticated design creates timeless exclusive interiors.

Art. 2049/CH6/LU
ø 60 cm H 80 cm
6 x G9 x Led 10W



Art. 2049/FL/SG
ø 60 cm H 170 cm
6 x G9 x Led 10W



Art. 2049/T/LU
ø 20 cm H 69 cm
3 x G9 x Led 10W



Art. 2049/A2/LU
L 18 cm H 60 cm
Sp 12 cm
2 x G9 x Led 10W



Art. 2049/T/CAFFE/LU
ø 20 cm H 69 cm
3 x G9 x 40W



Art. 2049/RETT10/CAFFE/LU
L 108 x 53 cm H 84 cm
10 x G9 x Led 10W

Art. 1930/CH12
 Ø 131 cm H 95 cm Pø 18 cm
 12 x E14 x 40W

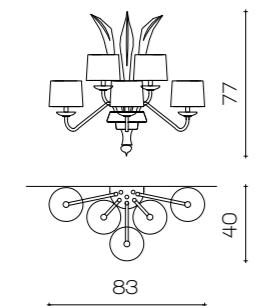

Art. 1930/A5
 L 83 cm H 77 cm
 Pø 18 cm Sp 40 cm
 5 x E14 x 25W

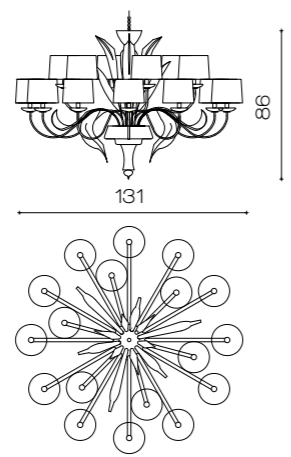

Art. 1930/CH18
 Ø 131 cm H 86 cm
 Pø 18 cm
 18 x E14 x 40W

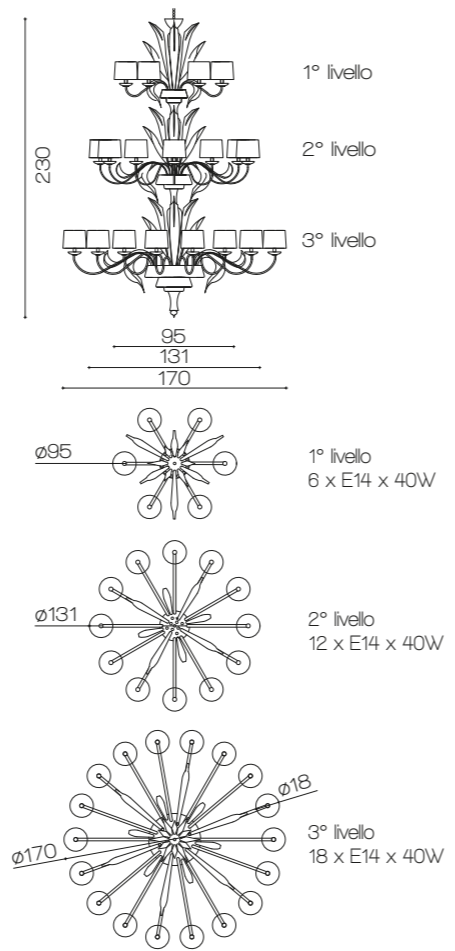

Art. 1930/CH36
 Ø 170 cm H 230 cm Pø 18 cm
 36 x E14 x 40W





Art. 1931/G/HONEY
Pø 37 cm H 97 cm
1 x E27 x 60W



Art. 1931/CH12
ø 117 cm H 95 cm
12 x E14 x 40W



Art. 1931/G/CAFFÉ
Pø 37 cm H 97 cm
1 x E27 x 60W



Art. 1931/A2
L 40 cm H 64 cm
Sp 20 cm
2 x E14 x 40W



Art. 1931/CH8
ø 89 cm H 77 cm
8 x E14 x 40W



Art. 1931/G/FUMÉ
Pø 37 cm H 97 cm
1 x E27 x 60W



Art. 1931/G/RED
Pø 37 cm H 97 cm
1 x E27 x 60W



Art. 2079/A5/LU
 L max 48 cm Sp 31 cm
 H 41 cm (without bulb)
 5 x E14 x Led 5W



Art. 2079/CH30/LU
 ø 110 cm H 77 cm
 +50 cm steel cable
 30 x E14 x Led 5W
 +3 x GU10 x Led 10W



Art. 2079/OVALCH16/LU
 L 150 x 82 cm H 77 cm
 +50 cm steel cable
 16 x E14 x 25W
 +3 x GU10 x Led 10W



Art. 2079/T/OV
 ø 26 cm H 72 cm Pø 12 cm
 3 x E14 x 25W



Art. 2079/CH18/NL/BI
 ø 128 cm Pø 18 cm H 77 cm
 +50 cm steel cable
 18 x E14 x 25W
 +3 x GU10 x Led 10W

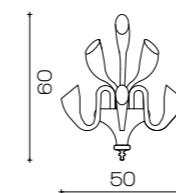

Art. 1965/A6
 ø 50 cm H 60 cm
 6 x G9 x 40W

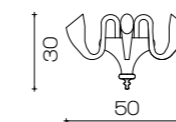

Art. 1965/A3
 ø 50 cm H 30 cm
 3 x G9 x 40W

Art. 1965/CH15
 ø 110 cm H 80 cm
 15 x G9 x 40W

Lampadario in vetro di Murano trasparente, dal design esclusivo degli elementi sapientemente forgiati da alta maestria artigianale vetraia, sintesi di linee geometriche scolpite che determinano una grande personalità. Ogni braccio viene coronato con un colletto di ottone cromato con inseriti uno ad uno Swarovski Elements. Paralumi in organza bianca lucida su pvc decorati con passamaneria barocca argentata. Pensato e costruito Full made in Italy.



Art. 1770/CH18
Ø 144 cm H 102 cm
PØ 12 cm
18 x E14 x 25W

design: Arch. Federica Vicentini
"International Design Registration N°: DM/079817"



Люстра из прозрачного муранского стекла с эксклюзивным дизайном элементов, умело изготовленных первоклассными мастерами стекольного дела, является синтезом плавных геометрических линий. Каждый рожок коронован хромированным наконечником с инкрустацией вручную каждого отдельного кристалла Swarovski Elements. Абажуры выполнены из белой блестящей органзы на ПВХ и украшены серебряной оборкой барокко.

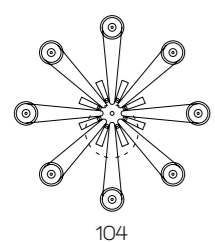

Art. 1770/CH8
 Ø 104 cm H 90 cm PØ 12 cm
 8 x E14 x 25W

design:
 Arch. Federica Vicentini
 "International Design
 Registration N°: DM/079817"



Ninfea. Chandelier made of transparent Murano glass by exclusive design of the elements skilfully forged by high glassmaking craftsmanship, synthesis of geometric lines that determine a great personality. Every arm of the chandelier is crowned with collar of chromed brass and Swarovski Elements carefully inserted one by one. The lampshades are made of white glossy organza on pvc base and decorated with silver baroque trimming. Designed and made Full made in Italy

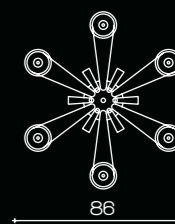

Art. 1770/CH6
 H 86 cm Ø 86 cm PØ 12 cm
 6 x E14 x 25W



Art. 1770/A1
 ø 32 cm H 42 cm
 Pø 12 cm
 1 x E14 x 25W

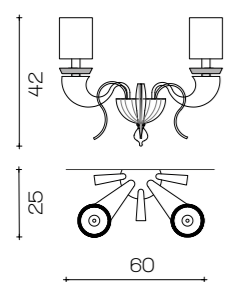

Art. 1770/A1
 ø 60 cm H 42 cm
 Pø 12 cm
 2 x E14 x 40W

Art. 1770/FL
 ø 50 cm H 182 cm
 1 x E27 x 60W



Art. 1770/A5
 ø 62 cm H 92 cm Pø 12 cm
 5 x E14 x 25W



design: Arch. Federica Vicentini
"International Design Registration N°: DM/079817"



Art. 1770/G
ø 50 cm H 94 cm
1 x E27 x 60W



Art. 1770/P
ø 12 cm H 28 cm
1 x E14 x 25W



Art. 1770/Flambeaux 8L
ø 62 cm H 97 cm
8 x E14 x 25W

Art. 1770/CH6/FUME/LU
ø 83 cm H 86 cm Pø 12 cm
6 x E14 x 25W



Art. 1770/CH6/BI/ORO24K
ø 83 cm H 86 cm Pø 12 cm
6 x E14 x 25W



Art. 1770/CH6/ROSSO/LU
ø 83 cm H 86 cm Pø 12 cm
6 x E14 x 25W



Art. 1770/CH6/AMBRA/LU
ø 83 cm H 86 cm Pø 12 cm
6 x E14 x 25W



Art. 1849/P
P ovale 40 x 23 cm H 92 cm
1 x E27 x 60W

Art. 1849/G
P ovale 46 x 26 cm H 108 cm
1 x E27 x 60W



82

Art. 1970/CH8/NL
ø 113 cm H 80 cm
8 x E14 x 40W



83

Il Paralume Marina

design:
Arch. Federica Vicentini
"International Design
Registration N°: DM/079817"

Art. 1969/CH8/NL
ø 107 cm H 80 cm
8 x E14 x 40W

Art. 2009/CH12
 ø 112 cm H 82 cm
 12 x E14 x 40W

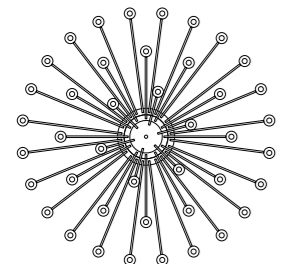
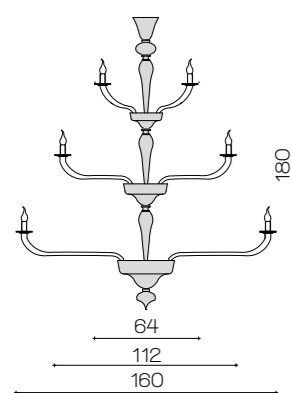

Art. 2009/CH42
 ø 160 cm H 180 cm
 42 (24+12+6) x E14 x 40W

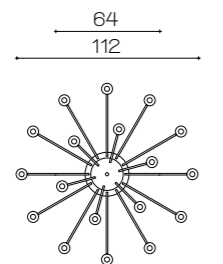
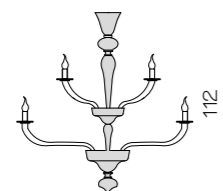

Art. 2009/CH18
 ø 112 cm H 112 cm
 18 x E14 x 40W

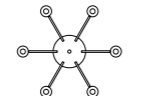
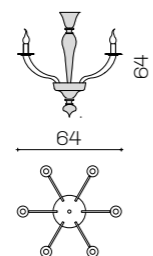

Art. 2009/CH6
 ø 64 cm H 64 cm
 6 x E14 x 40W

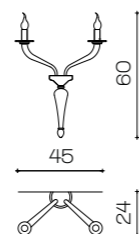

Art. 2009/A2
 L 45 cm H 60 cm
 Sp 24 cm
 2 x E14 x 40W

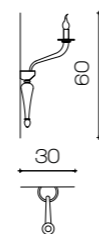

Art. 2009/A1
 H 60 cm
 Sp 30 cm
 1 x E14 x 40W



Art. 2135/CH18
 ø 112 cm H 100 cm
 18 x E14 x Led 5W



86

Art. 2137/CH15
ø 110 cm H 95 cm Kg 20
+50 cm chain and ceiling cup
15 x E14 x Led



87

Il Paralume Marina

Art. 2136/CH15
ø 116 cm H 95 cm Pø 18 cm Kg 20
+50 cm chain and ceiling cup
15 x E14 x Led



88

Art. 1932/CH8
ø 96 cm H 82 cm
8 x E14 x 40W



89

*The strength and the uniqueness of murano's glass
revive in this contemporary interpretation of
ca' Rezzonico: the mirrored elements give poetic
elegance to any interior.*

Il Paralume Marina

Art. 1932/CH24
ø 144 cm H 92 cm
24 x E14 x 40W



Art. 1932/A1
L 10 cm H 52 cm
Sp 18 cm
1 x E14 x 40W



Art. 1935/FL
Pø 58 cm H 187 cm
2 x E27 x 60W

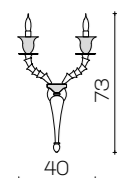

Art. 1932/A2
L 40 cm H 73 cm
Sp 24 cm
2 x E14 x 40W

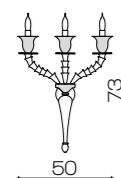

Art. 1932/A3
L 50 cm H 73 cm
Sp 24 cm
3 x E14 x 40W



Art. 1935/CH8
ø 114 cm H 82 cm
Pø 24 cm
8 x E14 x 40W





Art. 1948/LU
 P oval 46x25 cm H 98 cm
 1 x E27 x 60W
 Nappa N.10 Oro



Art. 1947/NL
 Pø 38 cm H 98 cm
 1 x E27 x 60W
 Nappa N.10 Argento



Art. 1834/FL
Pø 50 cm
H 189 cm
2 x E27 x 60W



Art. 1834/G
Pø 20 cm H 63 cm
1 x E27 x 60W

Art. 1834/P
Pø 18 cm H 47 cm
1 x E14 x 40W



Art. 1834/CH8
ø 93 cm H 76 cm Pø 20 cm
8 x E14 x 40W



Art. 1834/A2
Pø 40 cm
H 50 cm
2 x E14 x 40W



96

Art. 1919/CH54
L 190x91 cm
H 160 cm Pø 12 cm
54 x E14 x 25W
+7 GU10 Led 10W
with Asfour crystal



97

Art. 1918/CH32
L 160x65 cm
H 75 cm Pø 12 cm
32 x E14 x 25W
+7 GU10 Led 10W

Cerchi in finitura oro oppure ottone cromato sostengono file di perle di cristallo, collane lucenti che definiscono ambienti ricercati, eleganti, evocativi. Paralumi in organza bianca lucida su pvc sono decorati da passamaneria filo oro.

The brass circles in chrome or in gold cover support the rows of crystal pearls, they are like sparkling necklaces that identify the elegant evocative ambiances. The lampshades in white shiny organza on pvc are decorated with gold thread trimming.

Кольца из латуни, под золото или хромированные, поддерживают ряды хрустальных бус. Эти сияющие ожерелья задают тон изысканности и элегантности. Абажуры из белой блестящей органзы на ПВХ обведены золотыми тесёмками.





Art. 1703/FL/LU/TR
ø 65 cm H 190 cm Pø 12 cm
8 x E14 x 40W



Art. 1703/CH24/LU/TR
ø 112 cm H 120 cm Pø 12 cm
24 x E14 x 40W +3 GU10 Led 10W

Art. 1703/CH8/LU/TR
 ø 65 cm H 82 cm
 Pø 12 cm
 8 x E14 x 25W



102



Art. 1703/A4/LU/TR
 ø 43 cm H 50 cm
 Pø 12 cm
 4 x E14 x 25W

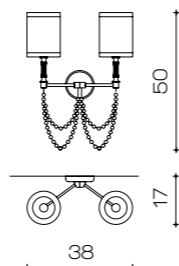

Art. 1703/A2/LU/TR
 L 38 cm H 50 cm
 Sp 17 cm Pø 12 cm
 2 x E14 x 25W

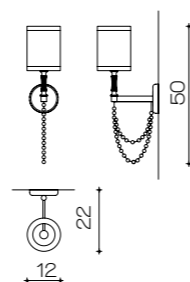

Art. 1703/A1/LU/TR
 L 12 cm H 50 cm
 Sp 22 cm Pø 12 cm
 1 x E14 x 25W

103



Il Paratume Marina

Art. 1703/G/LU/TR
 ø 42 cm H 82 cm Pø 12 cm
 4 x E14 x 25W



Art. 1949/A2/LU
L 40 cm H 52 cm
Sp 21 cm Pø 14 cm
2 x E14 x 25W



Art. 1949/FL/LU
ø 64 cm H 192 cm
Pø 14 cm
8 x E14 x 25W



Art. 1949/CH16/LU
ø 111 cm H 111 cm
Pø 14 cm
16 x E14 x 25W



Art. 1949/FLAMBÒ/LU
ø 42 cm H 83 cm
Pø 14 cm
4 x E14 x 25W



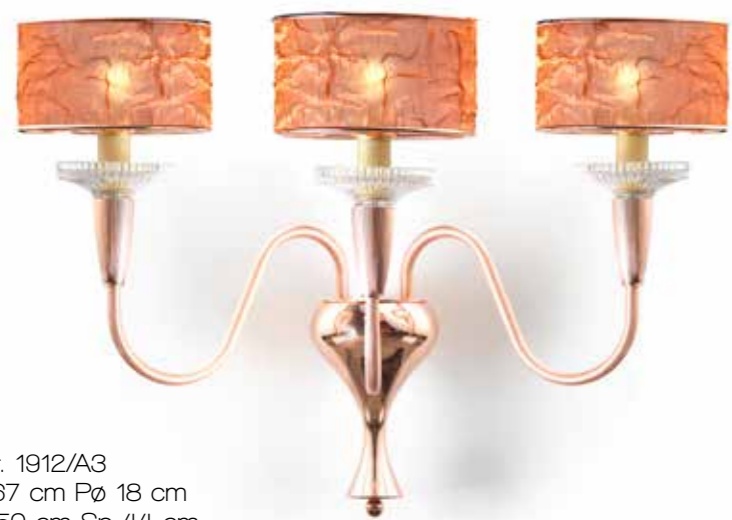

Art. 1912/A3
L 67 cm Pø 18 cm
H 50 cm Sp 44 cm
3 x E14 x 40W



Art. 1912/P
Pø 25 cm H 46 cm
1 x E27 x 60W

Art. 1912/G
Pø 40 cm H 82 cm
1 x E27 x 60W



Set of lighting objects by exclusive design obtained from dimpled tube, lampshades in fabric with copper on transparent pvc base and shiny metal parts make this combination well-balanced



Art. 1912/CH12
ø 140 cm H 102 cm
Pø 18 cm
12 x E14 x 40W



Art. 1912/CH8/ORO24K
ø 111 cm H 75 cm
Pø 18 cm
8 x E14 x 40W

Art. 1912/CH5/NL
ø 74 cm H 54 cm
Pø 18 cm
5 x E14 x 40W



Art. 1913/A1/NL
 Pø 15 cm H 20 cm
 1 x E14 x 40W



Art. 1913/CH8/NN
 ø 92 cm H 80 cm Pø 15 cm
 8 x E14 x 40W +3 GU10 Led 10W

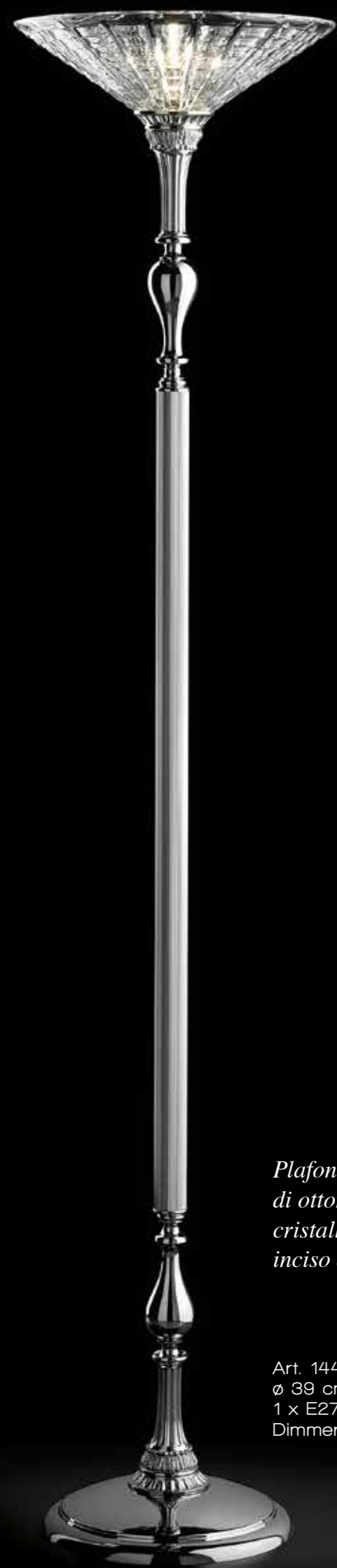

Plafoniera in fusione di ottone cromo con cristallo fiorentino inciso a mano.

Art. 1441/FL Cromo
ø 39 cm H 184 cm
1 x E27 x 60W
Dimmer included



Art. 1494/A
ø 50 cm H 20 cm
3 x E14 x 60W

Art. 1494/B
ø 50 cm H 20 cm
3 x E14 x 60W

Art. 1621/B Applique
ø 39 cm H 17 cm
1 x G9 x 40W

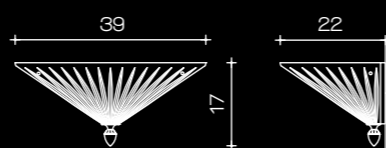

Lampada in cristallo fiorentino inciso a mano.

Paralume nero con bordo nero argento.

Paralume arricciato in seta pura e righine argento.

Art. 1410/P/KRTR
Pø 23 cm H 57 cm
1 x E27 x 60W

Art. 1410/G/KRTR
Pø 40 cm H 70 cm
1 x E27 x 60W
Nappa N.28

Metal Color: Oro24k



Art. 1910/CH8/ORO24K
ø 97 cm H 106 cm
8 x E14 x 60W 3 GU10
Led 10W

Collection of lighting objects
with micro casting animals,
enameled brass and bobcche in
clear italian hand-cut crystal.



Art. 1910/A1/ORO24K
L 25 cm H 43 cm Sp 15 cm
1 x E14 x 60W
+Led SMD bianco freddo Lumen
60 su Flex Strip 1,07W



Art. 1910/G/ORO24K
L 24 cm H 27 cm Sp 4,5 cm
Led SMD bianco freddo
Lumen 120 su Flex Strip 2,14W



Art. 1911/A/ORO24K
L 25 cm H 4,5 cm Sp 15 cm
Led SMD bianco freddo
Lumen 60 su Flex Strip 1,07W



Art. 1910/P/ORO24K
L 20 cm H 21 cm Sp 4,5 cm
Led SMD bianco freddo
Lumen 70 su Flex Strip 1,26W

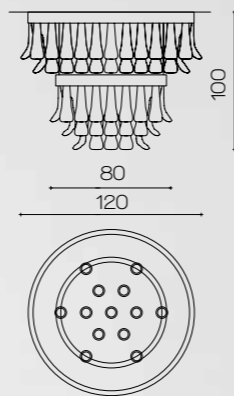

Art. 2015/NL
 ø 120 cm H 100 cm
 Lumen Colour light 2700 K°
 Lumen 7000 +12 x GU10 Led 5W
 (bulbs not included)

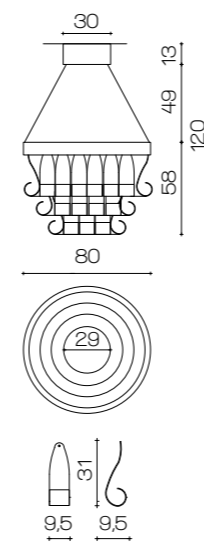

Art. 1937 Chandelier
 ø 80 cm H 58 cm
 +Ceiling plate H 13 cm ø 30 cm
 with 3 GU10 Led 10W H tot. 120 cm
 +Strip Led Colour light 2700 K° Lumen 8550

Illuminating metal rings with polished gold, priceless and fantastic glass' jewellery from the ancient italian tradition, revisited in a contemporary design. A fantasy and strictness mix



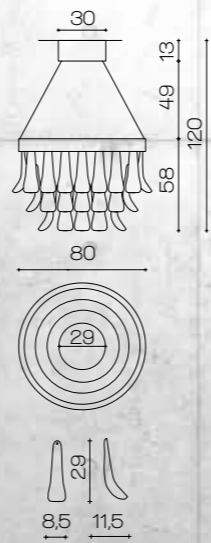

Art. 1939 Chandelier
 ø 80 cm H 58 cm +Ceiling plate
 H 13 cm ø 30 cm with 3 GU10 Led 10W
 H tot. 120 cm +Strip Led
 Colour light 2700 K° Lumen 8550

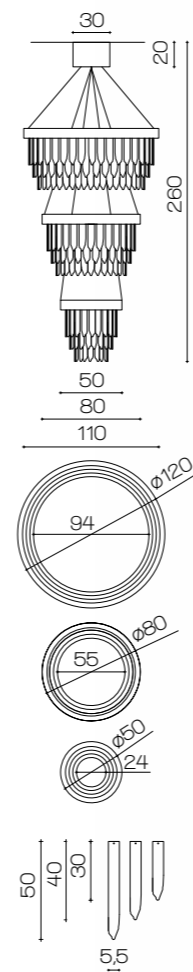

Art. 1961/LU
 ø 120 cm H 260 cm
 +Ceiling plate H 20 cm ø 30 cm
 with 3 GU10 Led 10W
 +Strip Led Colour light 2700°K Lumen 16530



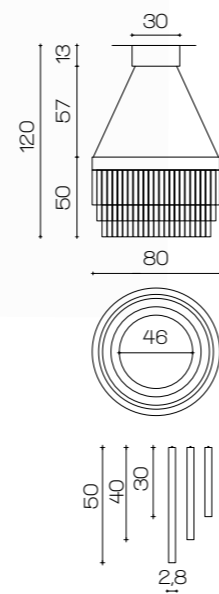

Art. 1971
 ø 80 cm H 50 cm
 +Ceiling plate H 13 cm ø 30 cm
 with 3 GU10 Led 10W H tot. 120 cm
 Luce colore 2700°K Lumen 8550

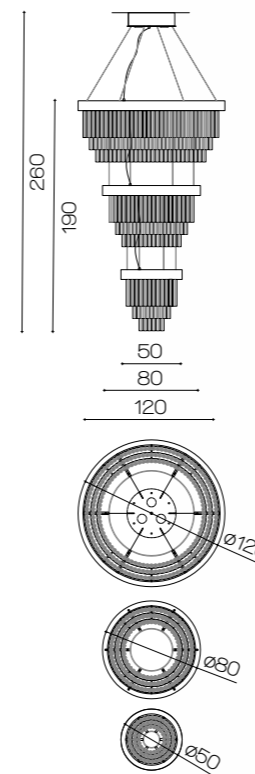

Art. 1972
 ø 120 cm H 190 cm
 +Ceiling plate H 20 cm ø 30 cm
 with 3 GU10 Led 10W +Strip Led
 Colour light 2700°K Lumen 16530



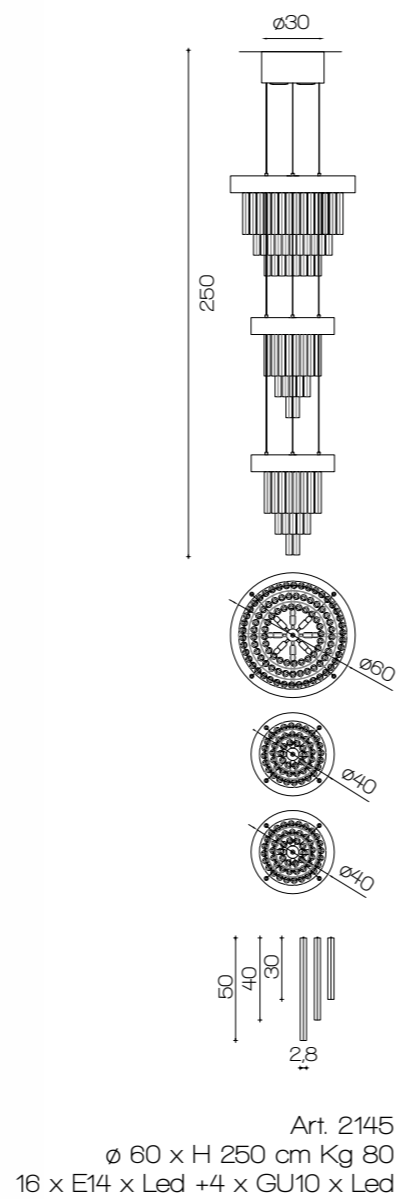



126

Art. 1994
L 80 x 60 cm H 50 cm
12 x E14 x 40W



127

II Paraltume Marina

Art. 1994/A
L 30 cm H 30 cm Sp 20 cm
2 x E14 x 40W

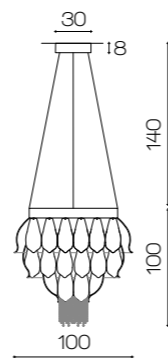

Art. 1984/P
 ø 100 cm H 100 cm
 +Ceiling plate ø 30 cm H 8 cm
 Steel cable 140 cm
 9 x E27 x 60W +3 GU10 Led 10W

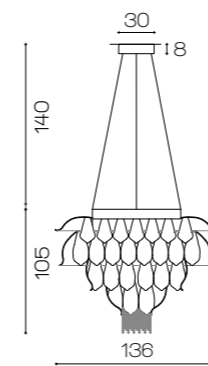

Art. 1984/G
 ø 136 cm H 105 cm
 +Ceiling plate ø 30 cm H 8 cm
 Steel cable 140 cm
 12 x E27 x 60W +3 x GU10 Led 10W



130

Art. 1966/NL
 ø 90 cm H 130 cm
 (only chandelier H 55 cm)
 12 x E14 x 40W
 +3 GU10 x Led 4W



131

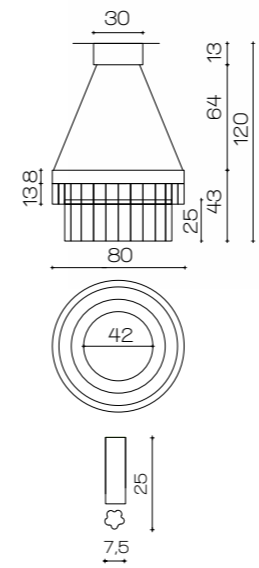

Art. 1960
 ø 80 cm H 43 cm
 +Ceiling plate H 13 cm ø 30 cm
 with 3 GU10 Led 10W H tot. 120 cm
 Colour light 2700 K° Lumen 8550



Art. 1958
GLASS CYLINDER
FLOWERS
Ø 80 cm H 285 cm
15 x G9 x 40W

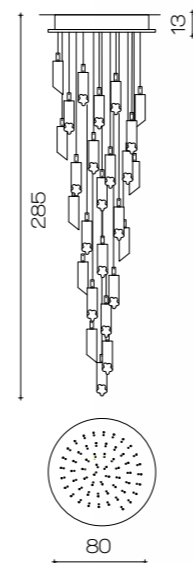
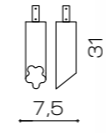

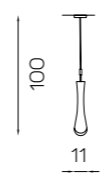

Art. 2182/1
 ø 11 cm H 100 cm
 1 x G9 x Led

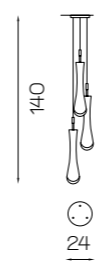

Art. 2182/3
 ø 24 cm H 140 cm
 3 x G9 x Led

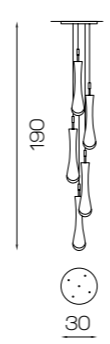

Art. 2182/5
 ø 30 cm H 190 cm
 5 x G9 x Led

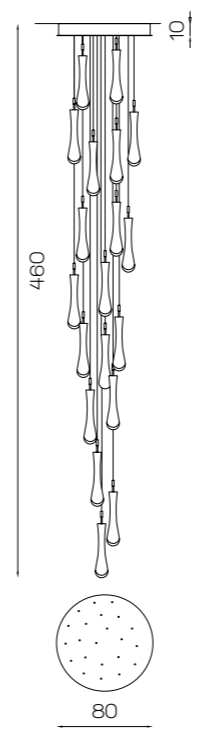

Art. 2182
 ø 80 cm H 460 cm
 22 x G9 x Led



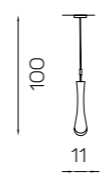

Art. 2181/1
 ø 11 cm H 100 cm
 1 x G9 x Led

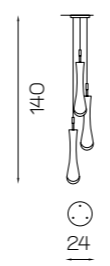

Art. 2181/3
 ø 24 cm H 140 cm
 3 x G9 x Led

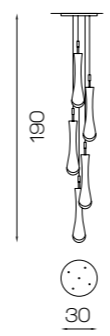

Art. 2181/5
 ø 30 cm H 190 cm
 5 x G9 x Led

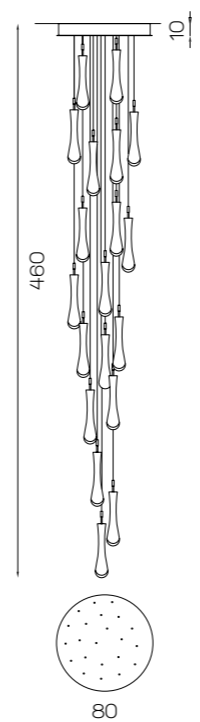

Art. 2181
 ø 80 cm H 460 cm
 22 x G9 x Led



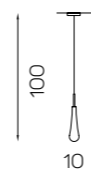

Art. 2183/1
ø 10 cm H 100 cm
1 x G9 x Led

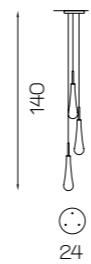

Art. 2183/3
ø 24 cm H 140 cm
3 x G9 x Led

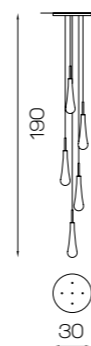

Art. 2183/5
ø 30 cm H 190 cm
5 x G9 x Led

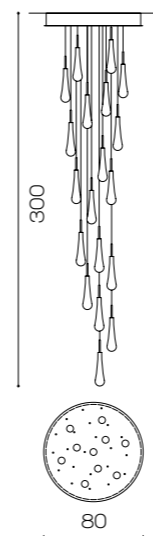

Art. 2183
ø 80 cm H 300 cm
22 x G9 x Led +10 x GU10 Led





Art. 1933
MURANO GLASS BAMBU'
Ø 56 cm H 285 cm
15 x E14 x 40W

Art. 1933 Led
MURANO GLASS BAMBU'
Ø 56 cm H 285 cm
57 Led 450W

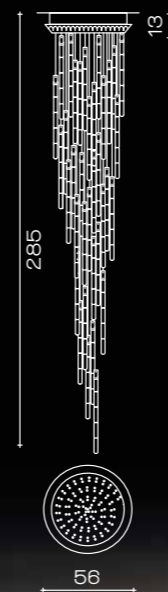
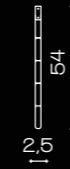

Waterfall of light and Murano's glass elements, decorative and amazing are perfect for any interior





Art. 1974
MURANO GLASS LEAF
ø 80 cm H 285 cm
15 x E14 x 40W

Art. 1974 LED
MURANO GLASS LEAF
ø 80 cm H 285 cm
57 Led 450W

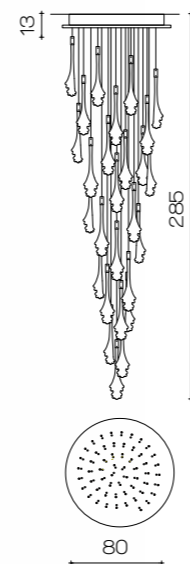



Art. 2002/A
L 40 cm H 100 cm Sp 23 cm
12 x Led 1,5W



Art. 2002/G
ø 25 cm H 60 cm
10 x Led 1,5W +2 x E14 x 40W



Art. 2002/CH
ø 30 cm H 200 cm
20 x Led 1,5W





Art. 1957 Led
MURANO GLASS
FLOWERS and BAMBU'
Ø 90 cm H 285 cm
57 Led 450W

Art. 1957
MURANO GLASS
FLOWERS and BAMBU'
Ø 90 cm H 285 cm
15 x E14 x 40W

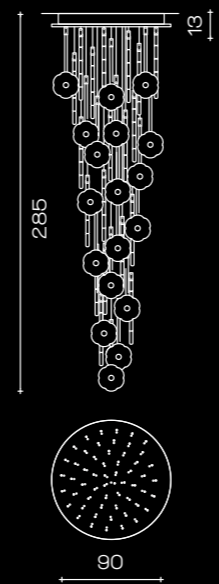
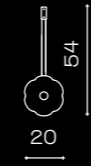

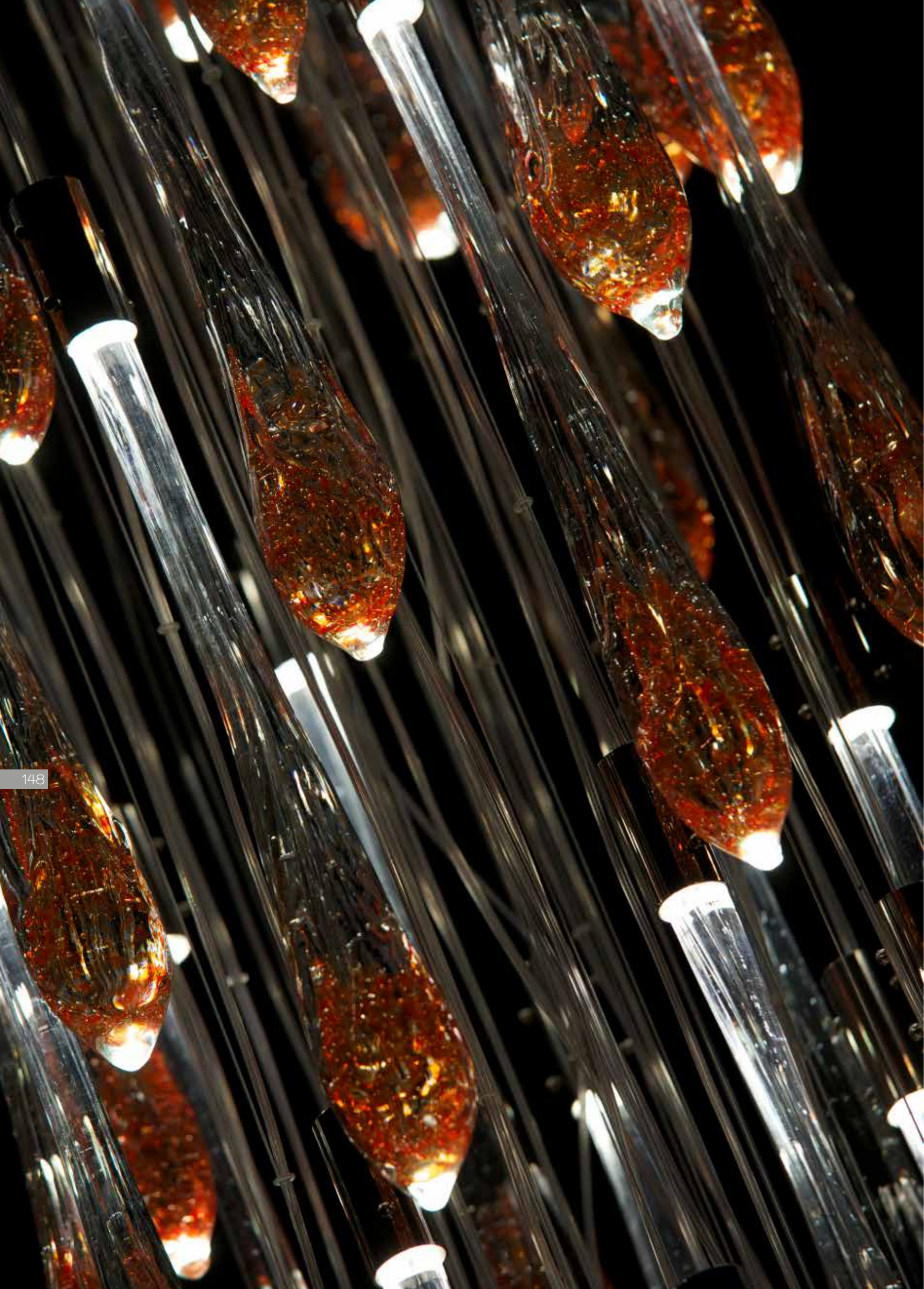

Art. 1934
MURANO RED DROPS
Ø 56 cm H 275 cm
15 x E14 x 40W

Art. 1934 LED
MURANO RED DROPS
Ø 56 cm H 275 cm
57 Led 450W

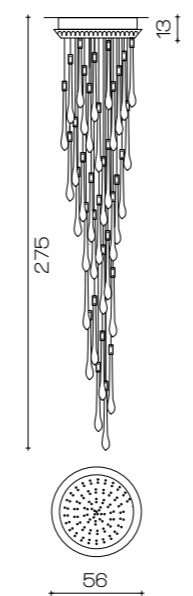
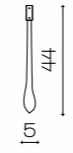

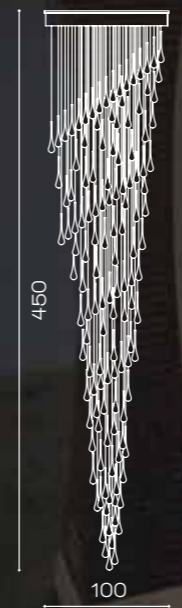

Art. 1810
Ø 100 cm H 450 cm
40 x E14 x 25W



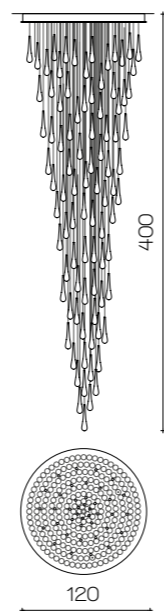

Art. 2023/CH40/LU
ø 120 cm H 400 cm
40 x E14 x Led 5W



Art. 2023/A2/LU
L 35 cm H 45 cm Sp 20 cm
2 x E14 x 40W



Art. 1359 small
 ø 30 cm H 45 cm
 6 x E14 x 40W



154

155

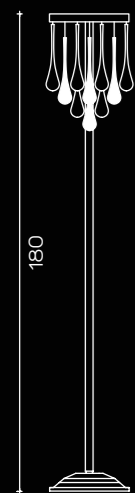

Art. 1359/FL
 ø 30 cm H 180 cm
 3 x E14 x 40W

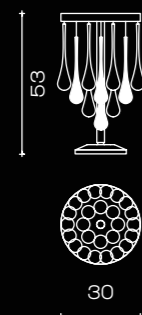

Art. 1359/TA
 ø 30 cm H 53 cm
 3 x E14 x 40W

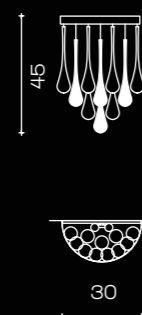

Art. 1359/A
 H 45 cm L 30 cm
 2 x E14 x 40W

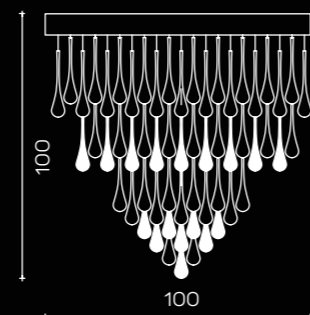

Art. 1615
 ø 100 cm H 100 cm
 16 x E14 x 60W

*Sospensione in vetro
 di Murano soffiato.*

*Fixture in Murano drops
 with interior little bubbles.*

*Плафон из Муранских подвесок
 с внутренними пузырями.*

Art. 1359
 ø 55 cm H 78 cm
 8 x E14 x 60W



Art. 1692/KR/TR/AM
L 60 x 30 cm H 65 cm
8 x E14 x 40W



Art. 1693KR/TR/NR
L 60 x 30 cm H 65 cm
8 x E14 x 40W

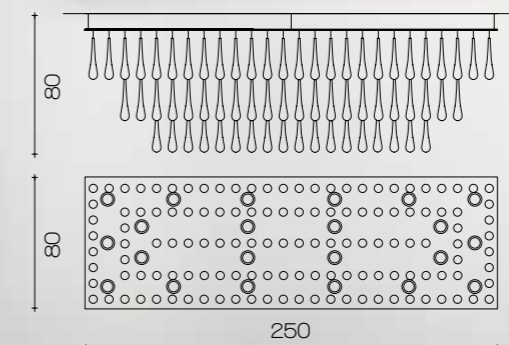
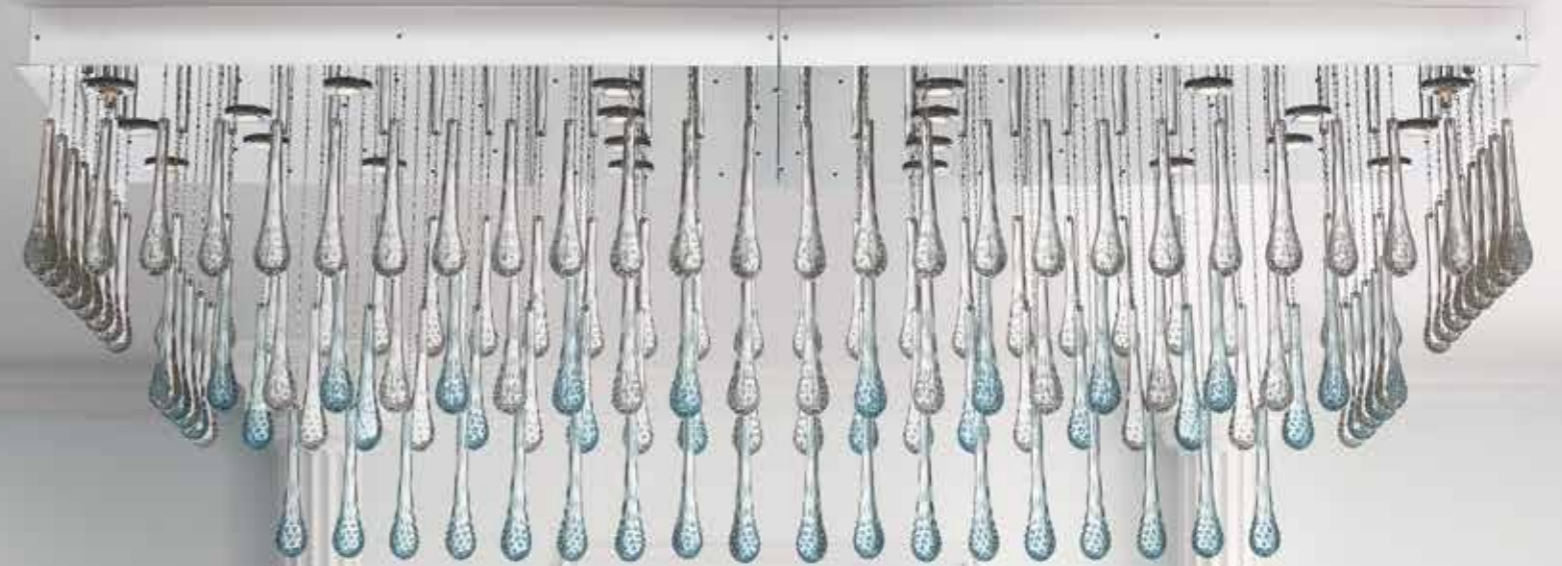

Art. 2016/STEEL
L 250 x 80 cm H 80 cm
22 x GU10 x Led 5W
(Available IP65)



Art. 2025/CH9/NN
ø 65 cm +chain 50 cm
9 x E14 x Led 5W



Art. 2098/NL
ø 65 cm H 39 cm
6 x E14 x Led 5W



Art. 2024/CH9/LU
ø 65 cm +chain 50 cm
9 x E14 x Led 5W



Art. 2029/CH30/LU
ø 70 cm H 300 cm
35 x E14 x Led 5W



Art. 2029/A/LU
L 36 cm H 70 cm
3 x E14 x 40W



Art. 2203
 ø 35 cm H 98 cm
 3 x E14 x Led



Art. 2204
 ø 35 cm H 48 cm
 2 x E14 x Led



Art. 2205
 ø 35 cm H 68 cm
 4 x E14 x Led



Art. 1993
Ø 70 cm H 50 cm
8 x E14 x 40W



Art. 1992
Ø 120 cm H 55 cm
20 x E14 x 40W





166

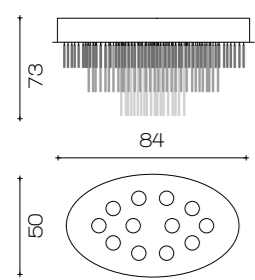

Art. 2027/OVALE/STEEL
L 84 x 50 cm H 40 cm
12 x GU10 x Led 10W



Art. 2026/A/STEEL
L 40 cm H 30 cm Sp 24 cm
2 x GU10 x Led 10W (Available IP65)



167



Art. 2026/STEEL
ø 120 cm H 120 cm
17 x GU10 x Led 10W (Available IP65)

The giant

This Cascade of three giant drops creates attractive lighting effect. It is the best expression of the excellence of high Murano craftsmanship.



Art. 2105/LU
ø 60 cm H 315 cm
ceiling plate ø 30 cm H 11 cm
3 x GU10 x 50W

Rain

Ceiling lamp with transparent, fume' and gold Murano glass drops is fit for bright installations of great scenic effect.

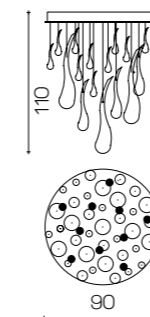

Art. 2063/Steel
ø 90 cm H 110 cm
10 x GU10 x 40W
(Available IP65)

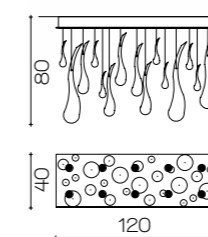

Art. 2062/Steel
L 120 x 40 cm H 80 cm
10 x GU10 x 40W
(Available IP65) (Available IP65)

Murano glass flowers made with different textures fly sinuously in the space. The designer played with antique working techniques of Murano glass: "Balaton", "Pulegoso", "a Fili" and "a Bolle" creating a striking but delicate composition.

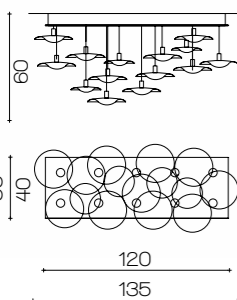

Art. 2059/Steel
L 135 x 55 cm H 60 cm
10 x GU10 x 40W

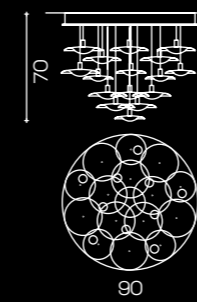

Art. 2060/Steel
ø 90 cm H 70 cm
10 x GU10 x 40W
(Available IP65)



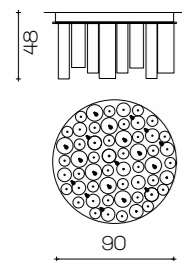

Art. 2078/Steel
 ø 90 cm H 48 cm
 18 x G9 x 25W Steel

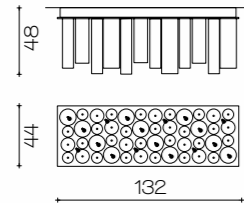

Art. 2077/Steel
 L 132 x 44 cm H 48 cm
 18 x G9 x 25W Steel

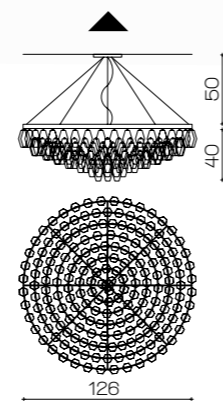

Art. 2081/NL
 ø 126 cm H 40 cm 50 Kg
 +50 cm Steel cable
 16 x E14 x 40W

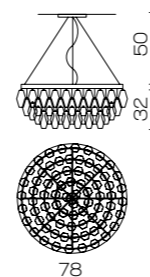

Art. 2082/NL
 ø 78 cm H 32 cm
 +50 cm steel cable
 8 x E14 x 40W

Metal Color: NL polished Nikel



Art. 2080/RETT/NL
 L 117 x 40 cm H 55 cm
 +100 cm steel cable
 12 x E14 x 40W



Art. 2080/ANL
 L 45 cm H 55 cm Sp 19 cm
 3 x E14 x 40W



Cloud

Ceiling lamp with oval bracelets of "pulegoso" glass creates a great and exciting aesthetic impact.

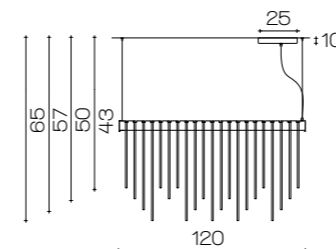



Art. 2108
 L 120 cm H max 65 cm
 Strip Led 3000K
 Lumen 1800/m 18W

Constellations

Plafond / wall sconce with circle of glass and silver leaf.

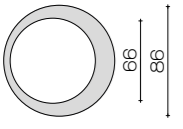
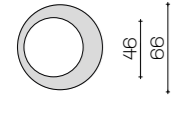

-  Art. 2107/G/NL
ø 86 cm Sp 8 cm
6 x G9 x 5W Led
-  Art. 2107/M/NL
ø 66 cm Sp 8 cm
3 x G9 x 5W Led
-  Art. 2107/P/NL
ø 30 cm Sp 8 cm
2 x G9 x 5W Led



Art. 2168/G
 Ø 50 cm H 9 cm
 8 x G9 x Led

Art. 2168/M
 Ø 38 cm H 9 cm
 6 x G9 x Led

Art. 2168/P
 Ø 20 cm H 9 cm
 3 x G9 x Led

	Art. 2175/G/SG Ø 86 cm Sp 8 cm 6 x G9 x Led
	Art. 2175/M/SG Ø 86 cm Sp 8 cm 6 x G9 x Led
	Art. 2175/P/SG Ø 30 cm Sp 8 cm 2 x G9 x Led



Constellations
 Plafond / wall sconce with circle
 of glass and gold leaf.

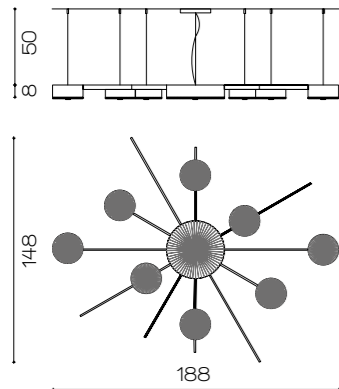

Art. 2166/CH30
L 188 x 148 cm H 9 cm
+50 steel cable
30 x G9 x Led

Art. 2165/CH30
L 188 x 148 cm H 9 cm
30 x G9 x Led



Cassiopea

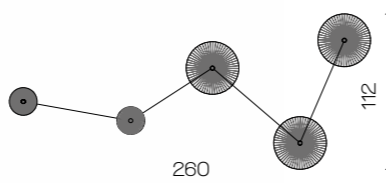

Art. 2166/WALL
L 260 x 112 cm H 9 cm
24 x G9 x Led

Moon

Dischi in cristallo italiano molato a mano "taglio Visù" si susseguono in questa composizione estremante dinamica ed elegante.

Extremely dynamic and elegant composition of discs in Italian hand-milled crystal 24K with "visù" cut.

Динамичная и элегантная композиция из хрустальных дисков с гравировкой «visù».



Art. 2167/P
ø 20 cm H 9 cm
3 x G9 x Led

Art. 2167/M
ø 38 cm H 9 cm
6 x G9 x Led

Art. 2167/G
ø 50 cm H 9 cm
8 x G9 x Led



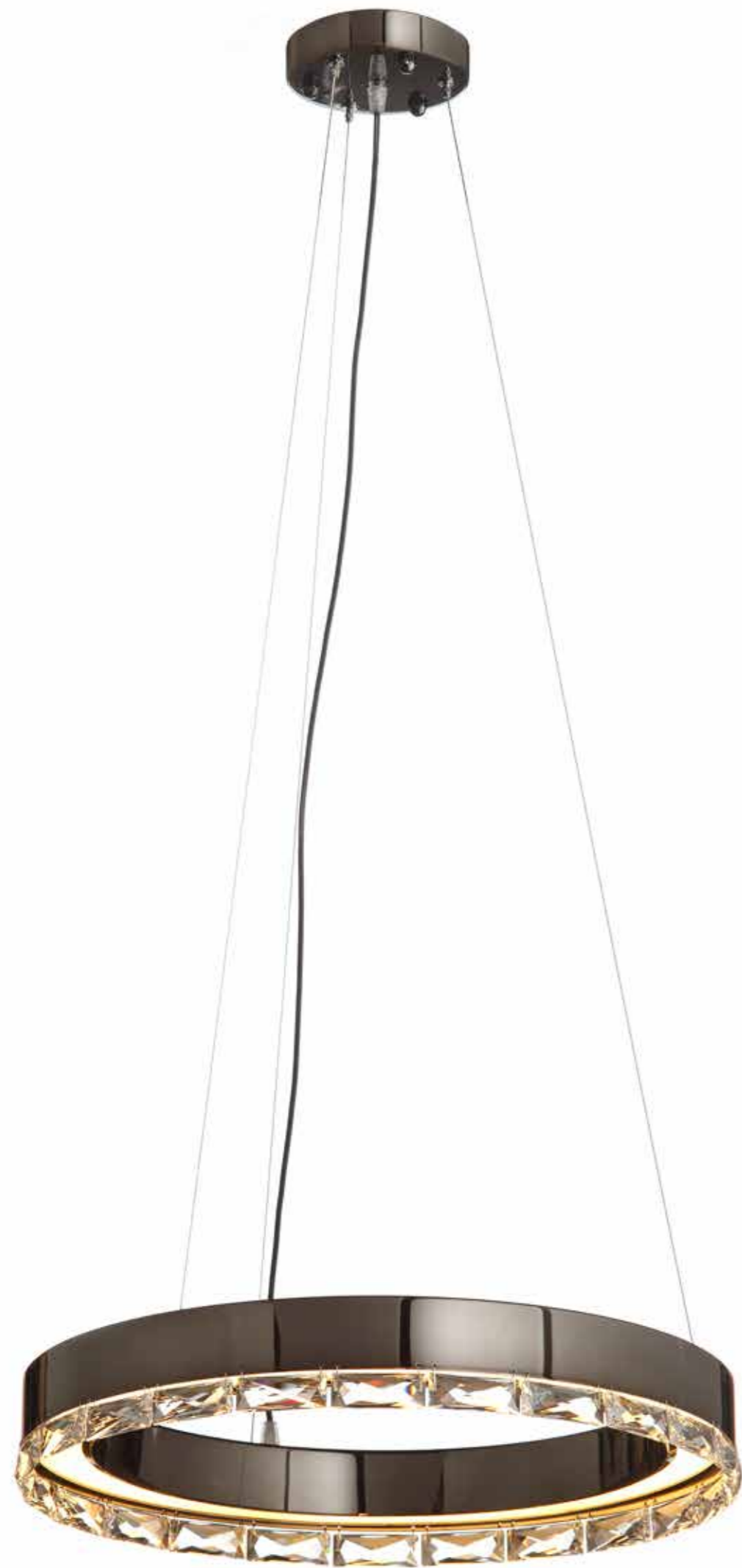

Rings with led and Swarovski Elements

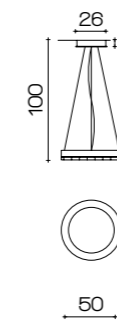

Art. 2103/P/NN
 ø 50 cm H 8 cm
 100 cm steel cable
 Strip Led 3200 K
 Lumen 3240 43W



Art. 2103/M/NN
 ø 70 cm H 8 cm
 100 cm steel cable
 Strip Led 3200 K
 Lumen 4860 64W

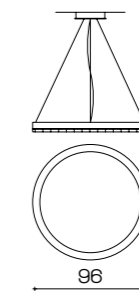

Art. 2103/G/NN
 ø 96 cm H 8 cm
 100 cm steel cable
 Strip Led 3200 K
 Lumen 7020 93W



Art. 2162/T
 ø 38 cm H 44 cm Sp 14 cm
 4 x G9 x Led



Eye

Ring in metallo nero opaco con lente in foglia oro e diffusore in cristallo italiano interamente molato a mano.

Ring in matt black metal with gold leaf lens and diffuser in Italian lead crystal entirely hand-milled.

Кольцо из матового черного металла с линзой в сусальном золоте и диффузором из итальянского хрусталя ручной резки.

Art. 2162/CH8
 ø 100 cm H 8 cm
 +50 cm steel cable
 8 x G9 x Led



Art. 2160
Ø 90 cm H 75 cm
+50 cm steel cable
1 x E27 Led +3 x G9 x Led



Art. 2161
Ø 130 cm H 100 cm
+50 cm steel cable
18 x G9 x Led



Art. 2180/A
L 23 cm H 76 cm Sp 20 cm
1 x E27 x Led



Bamboo

*Elementi illuminanti di metallo
finito in oro pallido si legano alla
leggerezza del vetro donando lusso ed
estrema eleganza alla composizione.*

Art. 2180/CH22
Ø max 101 cm H 65 cm
+100 cm Steel cable
22 x G9 x Led



Bamboo

Light fixtures in soft gold metal are combined with the lightness of glass, conferring a luxurious and highly elegant touch to the composition.

Светильники сочетают в себе прочность металла в отделке «светлое золото» и воздушность стекла, придавая всей коллекции оттенок элегантной роскоши.

Art. 2180/CH16
Ø max 101 cm H 45 cm
+100 cm Steel cable
16 x G9 x Led



Art. 2180/T
PØ 40 cm H 71 cm
1 x E27 x Led

193

Il Paralume Marina



Art. 2055/A/NN
L 20 cm H 54 cm
Sp 6 cm
4 x G9 x Led 10W



Art. 2054/CH16/NN
ø 100 cm H 45 cm
100 cm Steel cable
16 x G9 x Led 10W

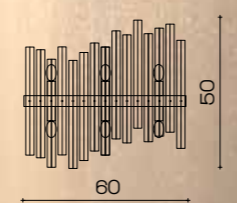

Art. 2054/A/NN
 L 60 cm H 55 cm Sp 12 cm
 6 x G9 x Led max 10W



Art. 2054/RETT/NN
 L 120 x 43 cm H 45 cm
 +55 cm Steel cable
 16 x G9 x Led 10W

Metal color: BR Brunito



198

Art. 2148
Ø 100 x H 30 cm glass Kg 50
+50 cm steel cable (total 80 cm)
12 x G9 x Led



199

Art. 2055/NL
L 120 x 55 cm H 12 cm
+50 cm Steel Cable
12 x G9 x Led 10W

II Paralume Marina

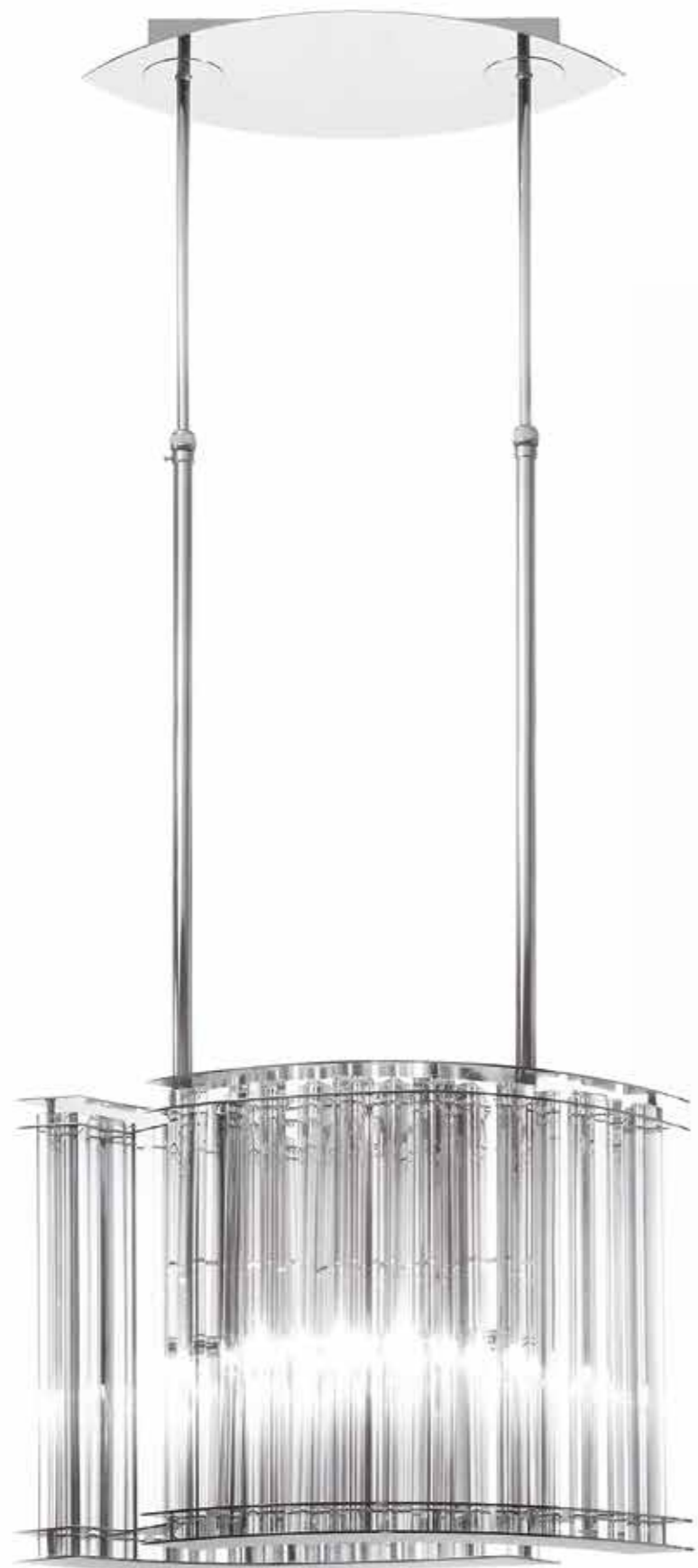

Art. 1638/A
L 40 cm H 20 cm
Sp 13 cm
2 x E14 x 60W



Art. 1638/KR/FUME'
L 49 x 22 cm H 37 cm
2 x E27 x 60W



Stecca di vetro di Murano
Trasparente - Fumè - Ambra

Art. 1638/CH2
L 49 x 22 cm H 117 cm
2 x E27 x 60W

Art. 1638/AM/LU
L 49 x 22 cm H 37 cm
2 x E27 x 60W

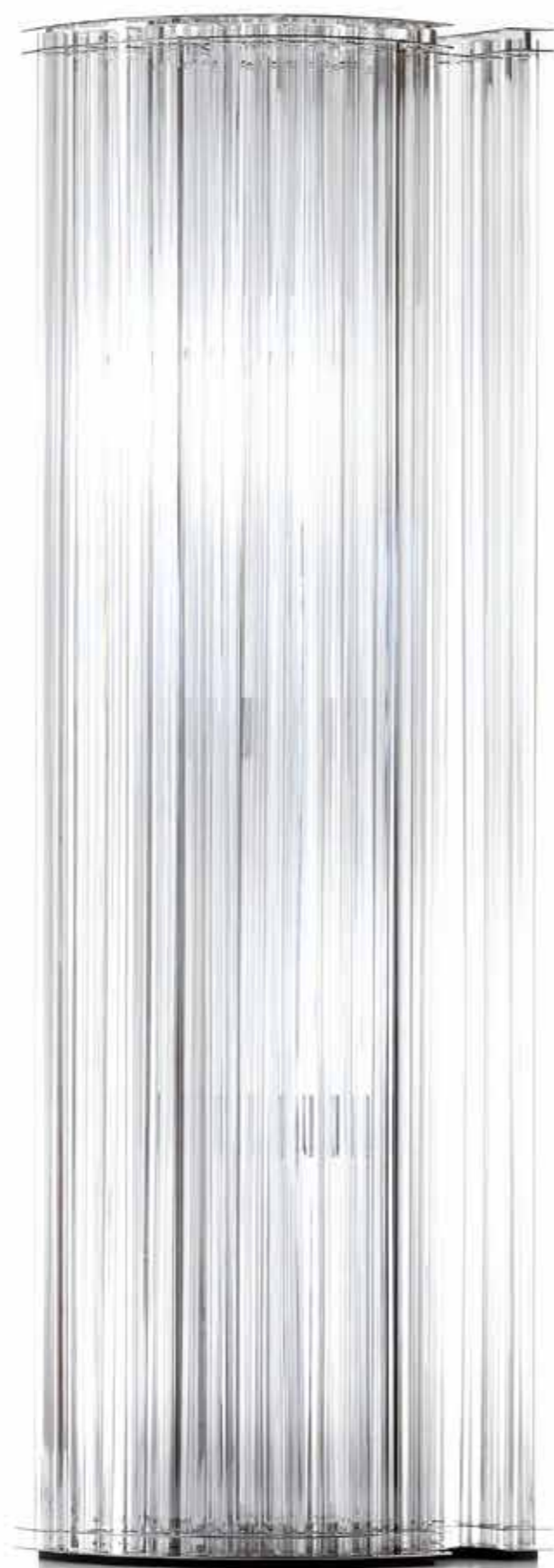

Art. 1638/FL
L 49 x 22 cm H 152 cm
6 x E27 x 60W



Art. 2031/CH9/NL
ø 95 cm +chain 50 cm
9 x E14 x Led 5W



202

203

Il Paralume Marina

204



Art. 2030/CH9/NL
ø 95 cm H 45 cm
chain 50 cm
9 x E14 x Led 5W

205

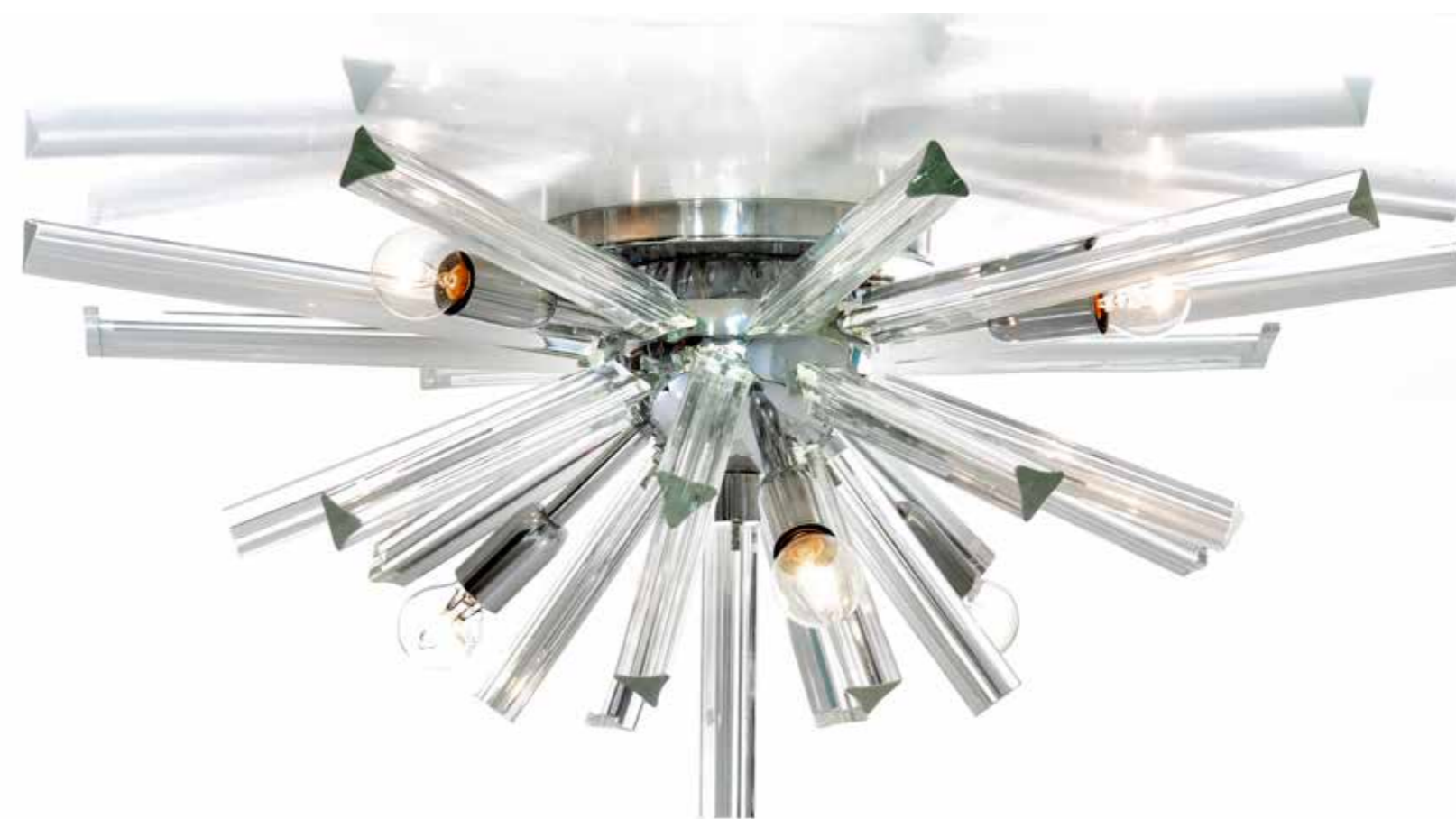

Art. 2030/A
ø 75 cm H 34 cm
6 x E14 x Led 5W



Art. 1214/SG
 P. lato 32 cm
 H 70 cm
 1 x E27 x 60W



Art. 1214/FL/SG
 P lato 40 cm
 H 180 cm
 1 x E27 x 60W

design: Arch. Massimo Bellunato



Art. 2147
 ø 80 x H 70 cm Kg 40
 6 x GU 10 x Led



Art. 1998
L 28 cm H 56 cm
Sp 18 cm
3 x E14 x 40W



Art. 1997
L 26 cm H 62 cm
Sp 13 cm
4 x E14 x 40W

Art. 2020/LU
L 200 x 110 cm H 28 cm
27 x E14 x Led 5W

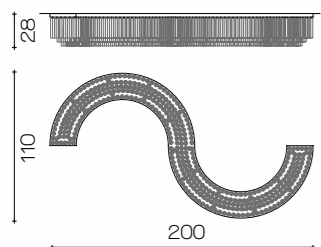



212

Art. 1512
L 120 x 60 cm H 60 cm
12 x E14 x 40W

Это не просто водопады кристаллов Swarovski Elements, это изделия, которые зажигают не только свет, но и эмоции. Они универсальны и предоставляют широкий спектр возможностей по персонализации. Изготовленные вручную, бабочки из муранского стекла по праву считаются ювелирными изделиями осветительных приборов.



213

II Paralume Marina

Art. 1796/BIS
ø 53 cm H 145 cm
12 x E27 x 60W

"Arte Brotto"

Art. 1660
Ø 85 cm H 100 cm
14 x E14 x 60W



Art. 1562
Ø 70 cm H 40 cm
10 x E14 x 40W



214

215

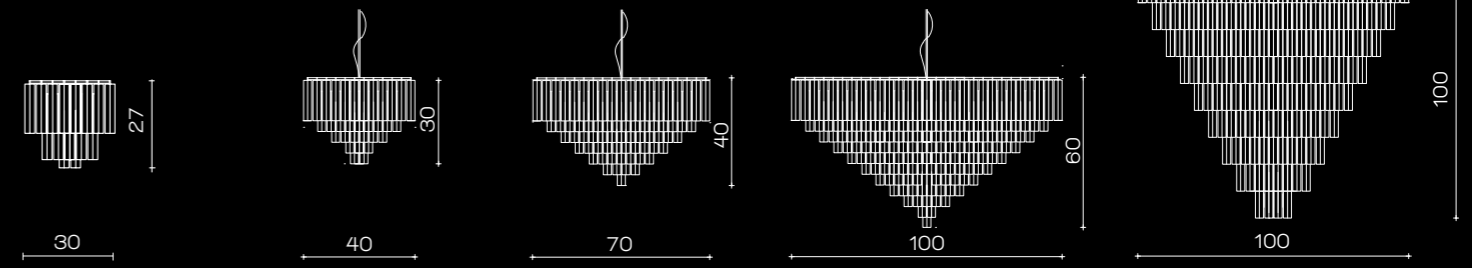

Art. 1561/A/bis
Ø 30 cm H 27 cm
2 x E14 x 60W

Art. 1561
Ø 40 cm H 30 cm
8 x E14 x 40W

Art. 1562
Ø 70 cm H 40 cm
10 x E14 x 40W

Art. 1563
Ø 100 cm H 60 cm
14 x E14 x 40W

Art. 1564
Ø 100 cm H 100 cm
14 x E14 x 40W



Art. 1691/KR/TR
ø 50 cm H 80 cm
10 x E14 x 40W



Art. 1887
ø 100 cm H 207 cm
14 x E14 x 40W
6 x E27 x 60W



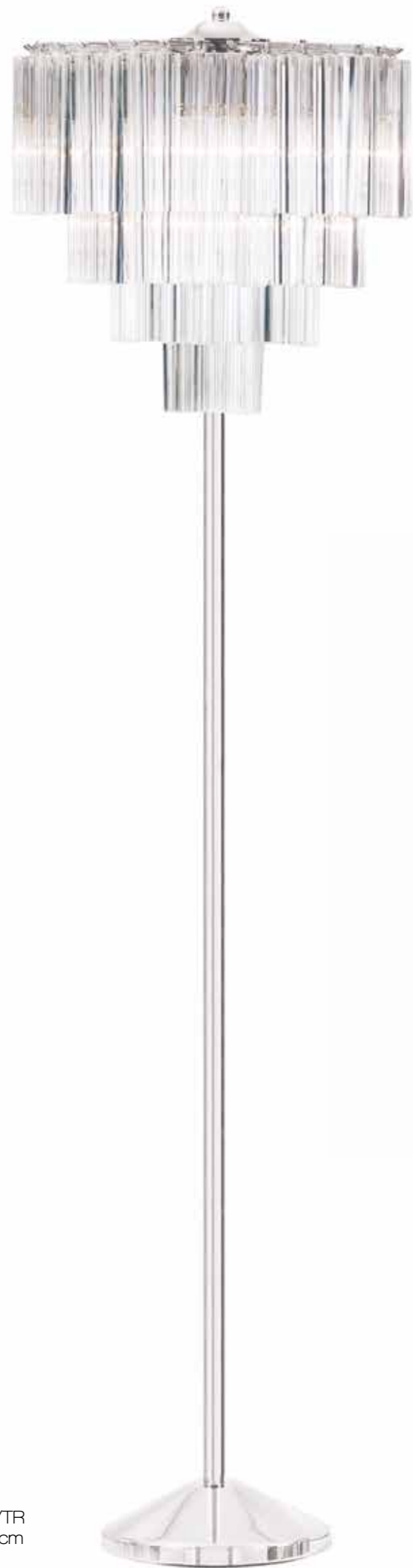

Art. 1691/FL/KR/TR
ø 60 cm H 178 cm
4 x E14 x 40W



Art. 1691/P/KR/TR
ø 20 cm H 45 cm
2 x E14 x 40W



Art. 1691/G/KR/TR
ø 30 cm H 63 cm
3 x E14 x 40W



Art. 1995
ø 80 cm H 55 cm
8 x E27 x 60W

Available:
Art. 1996
ø 50 cm H 50 cm
6 x E27 x 60W





Art. 1611/TA
 ø 28 cm H 42 cm
 1 x E27 x 100W

Art. 1610/TA
 ø 42 cm H 69 cm
 6 x E27 x 60W



Art. 1614/CH11
 ø 70 cm H 105 cm
 11 x E27 x 60W

Art. 1610/CH6
 ø 42 cm H 69 cm
 6 x E27 x 60W

Art. 1611/CH1
 ø 28 cm H 42 cm
 1 x E27 x 100W



*Cascata con tubo
diamantato in ottone
lucido, palline di Murano
e file di Swarovski.*

*A cascade of polished
brass diamond cutted,
Swarovski rows and
Murano glass valls.*

*Каскад из трубок
латуни рядов
Swarovski и шариков из
Муранского стекла.*



Art. 1493
ø 55 cm H 270 cm
15 x E14 x 40W



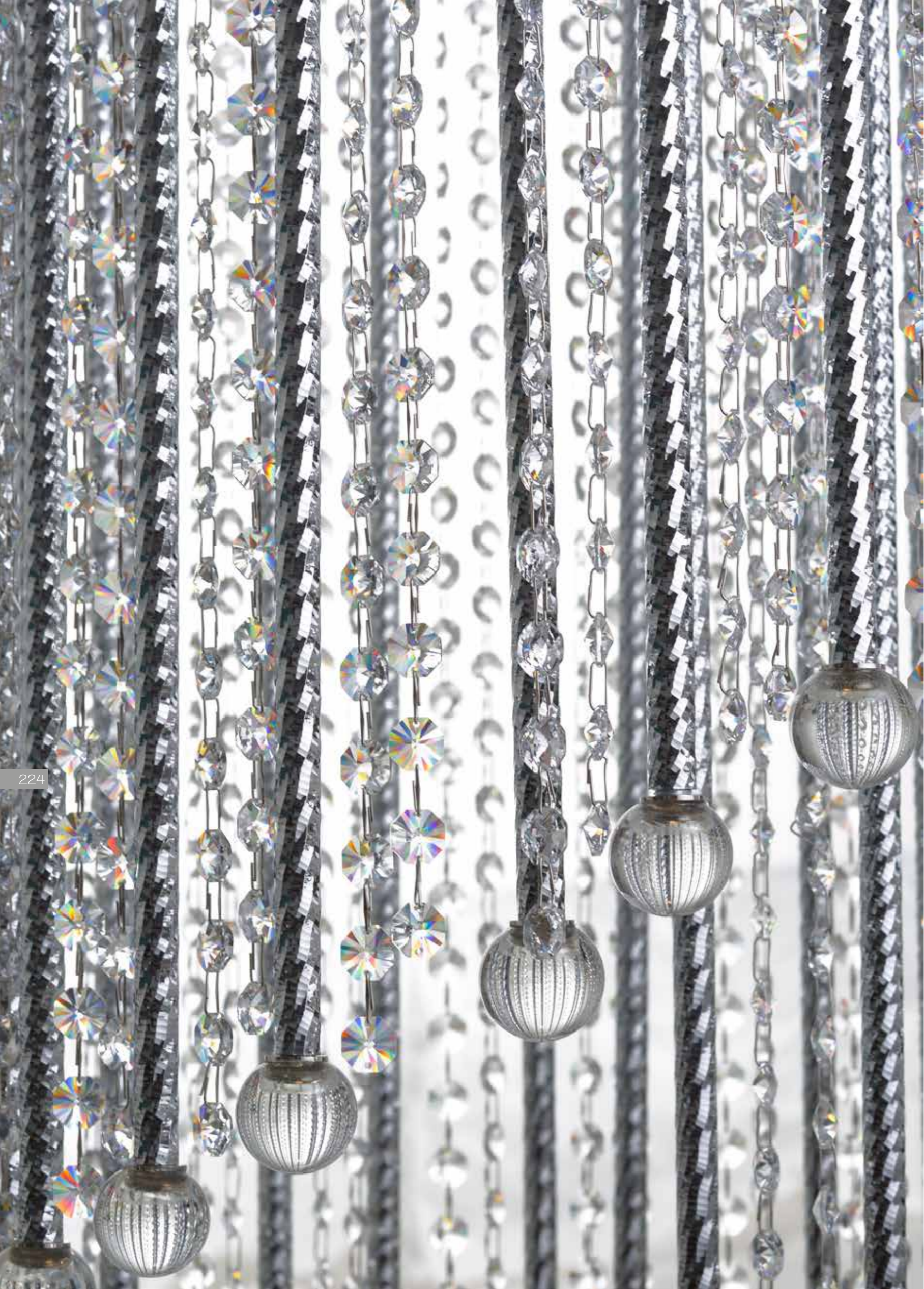

224



225

Il Paralume Marina

Art. 1928
diamond TUBE BRASS and
SWAROVSKI Spectra CRISTAL
ø 110 cm H 440 cm
20 x E14 x40W



Art. 1808
ø 60 cm H 120 cm
12 x E14 x 40W



Art. 2000
ø 70 cm H 85 cm
15 x E14 x 40W



Art. 2001
ø 80 cm H 225 cm
20 x E14 x 40W

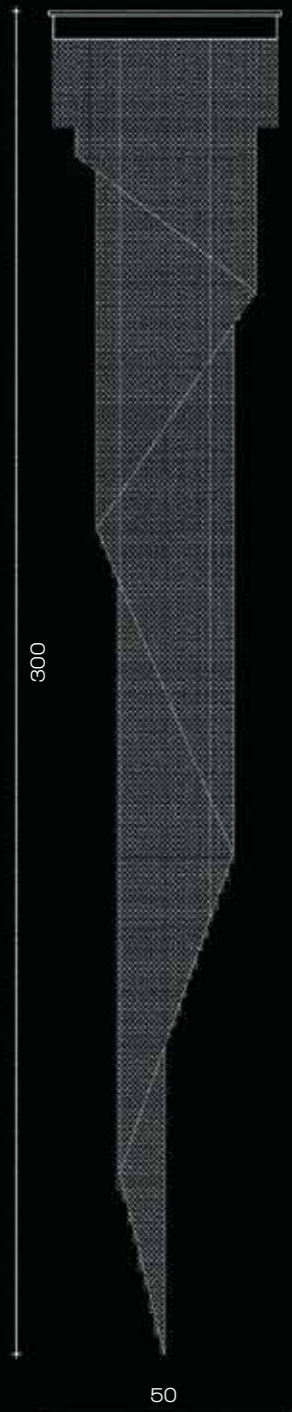

Art. 1379
 ø 50 cm H 300 cm
 12 x E14 x 60W

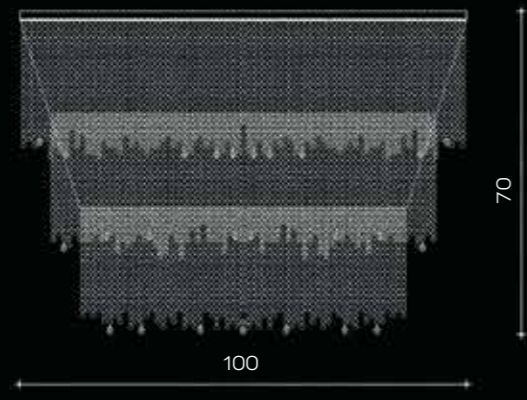

Art. 1535
 ø 100 cm H 70 cm
 12 x E14 x 60W

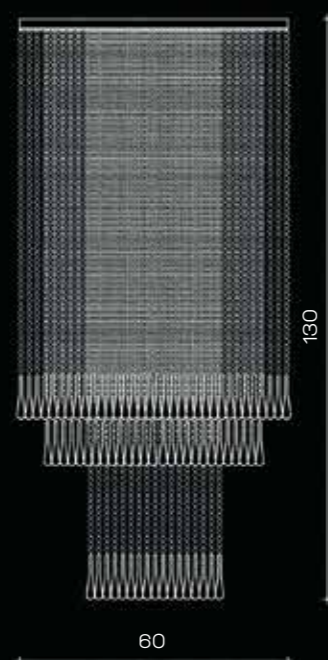

Art. 1536
 ø 60 cm H 130 cm
 12 x E14 x 60W

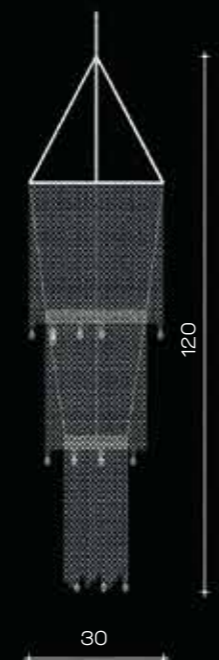

Art. 1534
 ø 30 cm H 120 cm
 8 x E14 x 60W

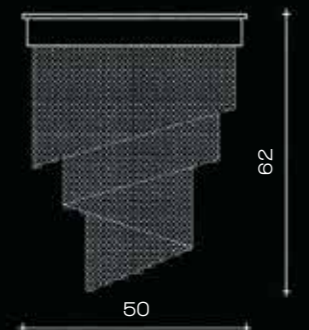

Art. 1537
 ø 50 cm H 62 cm
 10 x E14 x 60W

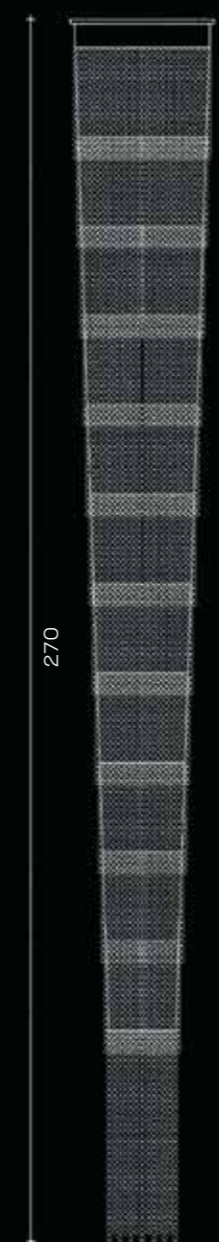

Art. 1538
 ø 30 cm H 270 cm
 12 x E14 x 60W



Art. 1279
 ø 30 cm H 50 cm
 1 x E27 x 60W



Art. 1701/P/OV/TR
 ø 30 cm H 70 cm
 4 x G9



Art. 1379/B
 ø 50 cm H 80 cm
 3 x E14 x 60W



*Serie di sospensioni
 in ottagoni Swarovski.*

Art. 1379
 ø 50 cm H 300 cm
 12 x E14 x 60W





230

Art. 1839
ø 45 cm H 30 cm
5 x G9 x 60W



231



Il Paratume Marina

Art. 1859/CH1/KR
ø 29 cm H 118 cm
1 x E27 x 60W



Art. 1702/KR/TR
 ø 53 cm H 130 cm
 13 x G9 x 25W

Art. 1701/KR/TR
 ø 40 cm H 100 cm
 8 x G9

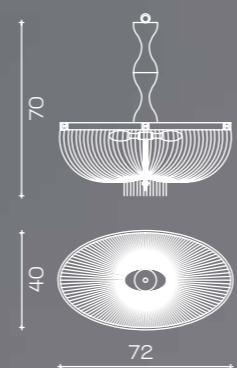

Art. 1820/CH ovale
 L 72 x 40 cm H 70 cm
 4 x E27 x 60W





234

Art. 1807
Ø 80 cm H 60 cm
8 x E14 x 40W

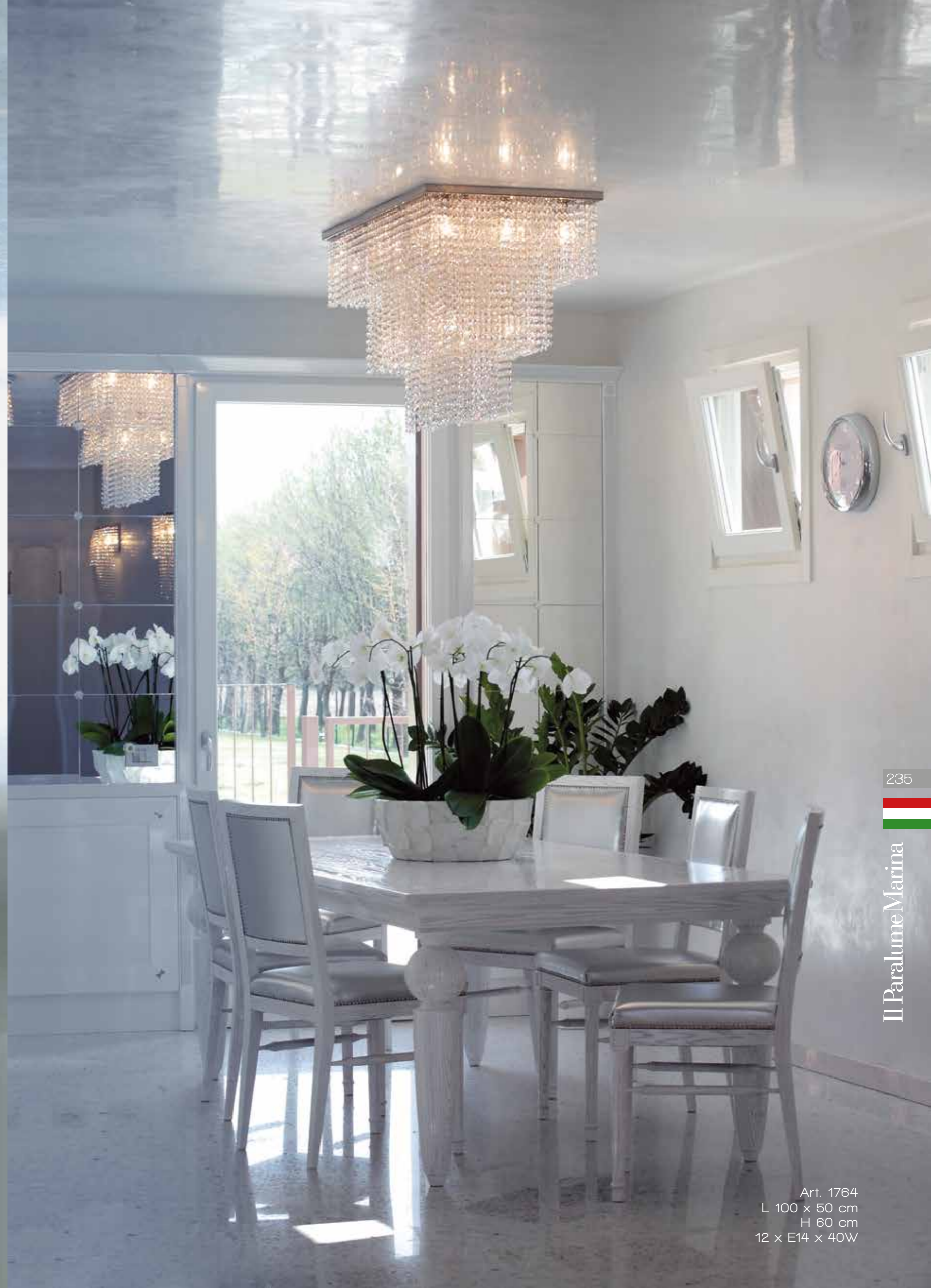

235



Il Paratume Marina

Art. 1764
L 100 x 50 cm
H 60 cm
12 x E14 x 40W



236

Art. 1764/A
L 25 cm H 50 cm
Sp 15 cm
2 x E27 x 60W



237

Art. 2040/LU
L 100 x 25 cm H 45 cm
6 x E14 x Led 5W

Il Paralume Marina



Art. 2018/NL
 ø 160 cm H 130 cm
 +50 cm Steel cable
 20 x E27 x 40W

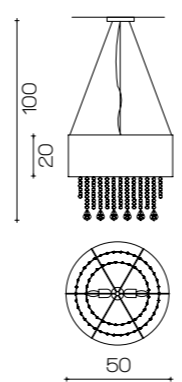

Art. 1386/CH2/NL
 Pø 50 cm H tot 100 cm
 +50 cm Steel cable
 2 x E27 x 60W

Art. 1386/CH4
 Pø 100 cm H 120 cm
 +50 cm Steel cable
 4 x E27 x 60W

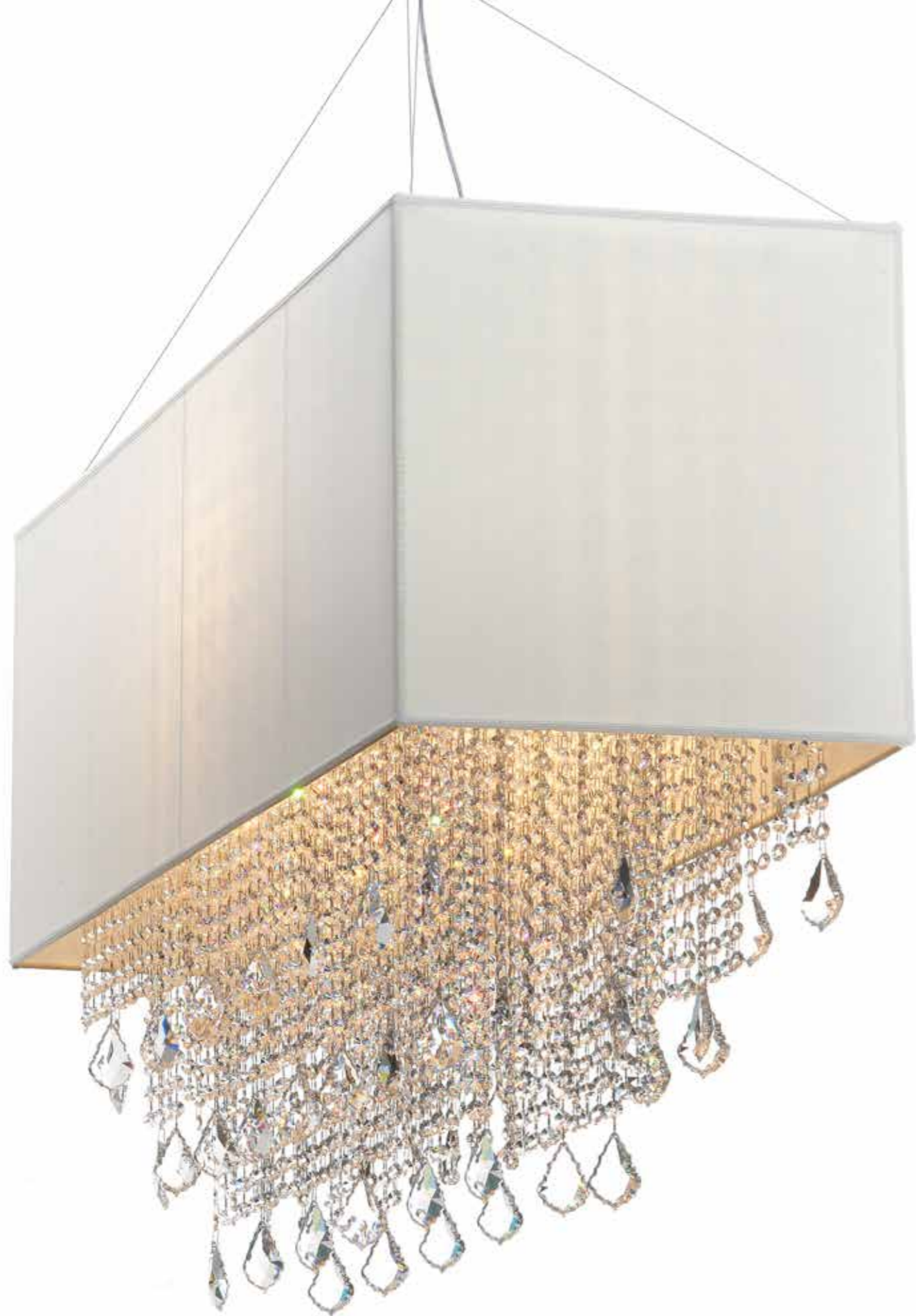

Art. 2052/NL
L 120 x 40 cm H 70 cm
+100 cm Steel cable
6 x E14 x 40W

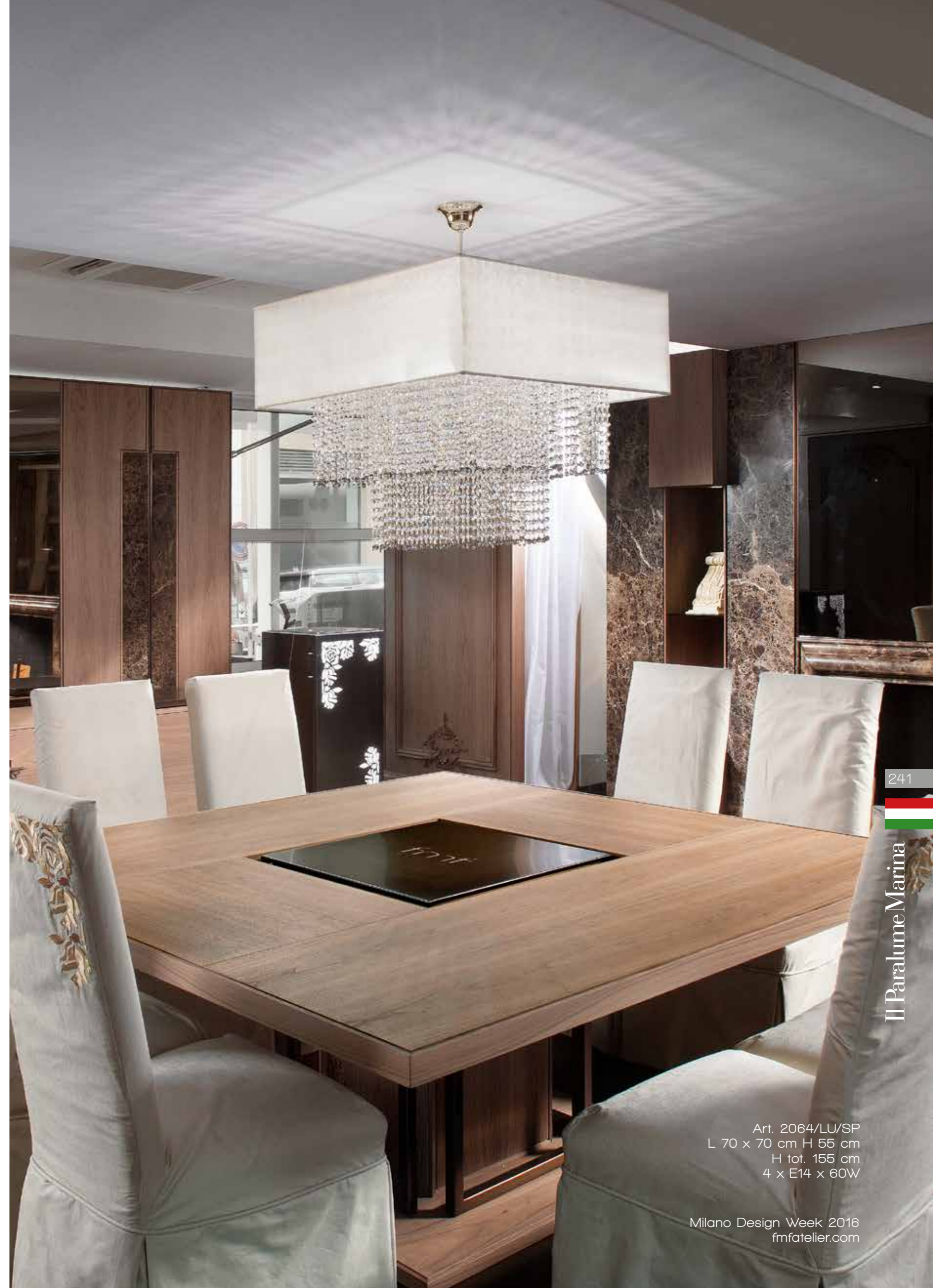

Art. 2064/LU/SP
L 70 x 70 cm H 55 cm
H tot. 155 cm
4 x E14 x 60W

Milano Design Week 2016
fmfatelier.com

Paralume Marina

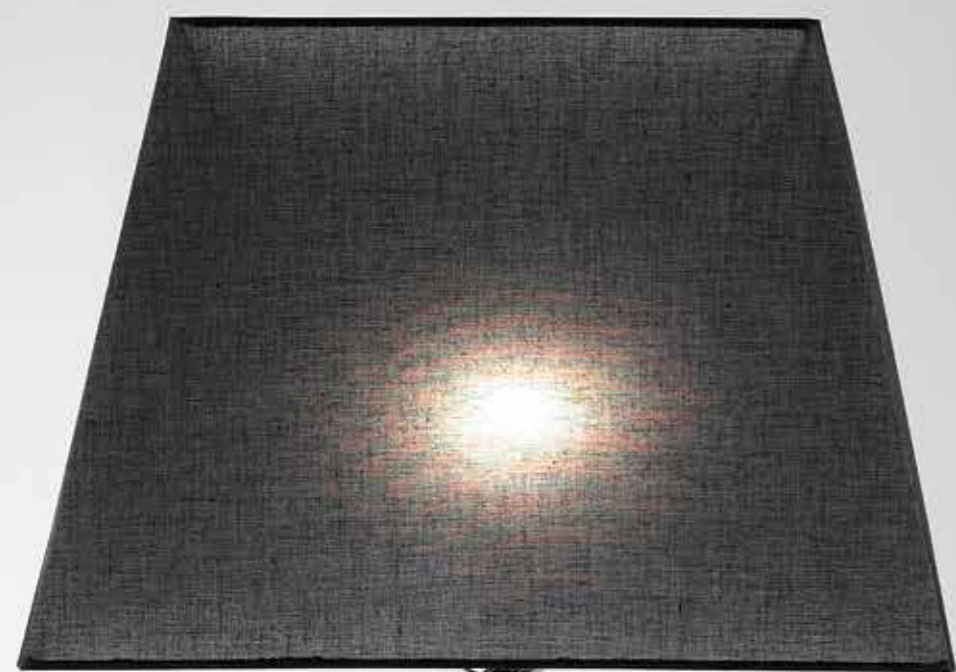

242



Art. 1504/G
L 35 cm H 65 cm
1 x E27 x 60W

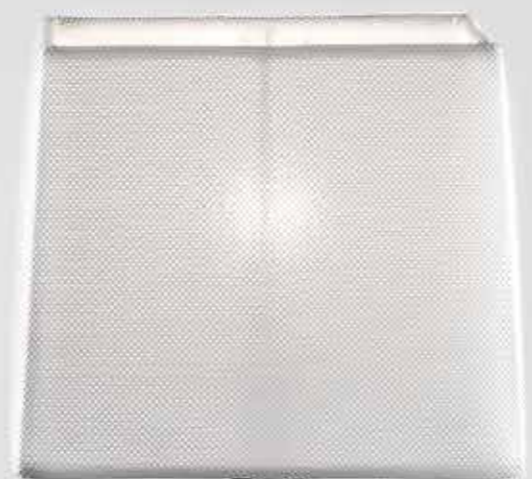

Art. 1504/P
L 16 cm H 40 cm
1 x E14 x 40W



243

*Paralume quadro con
organza grigia e file
di Swarovski viola.*

Art. 1271/FL/BIS
PL 40 cm H 175 cm
1 x E27 x 60W



Art. 1271/FL gius
Pø 50 cm H 180 cm
1 x E27 x 100W



Art. 1227/A
ø 40 cm
H 119 cm
2 x E27 x 60W



Art. 1271/M
Pø 25 cm H 63 cm
1 x E14 x 60W

Art. 1299
ø 50 cm H 80 cm
1 x E27 x 60W



Art. 1271/T
ø 30 cm H 75 cm
1 x E27 x 60W

Art. 1271/FL
ø 50 cm H 180 cm
1 x E27 x 60W





Art. 1258/S
ø 20 cm H 65 cm
1 x E27 x 60W

Art. 1190
ø 30 cm H 190 cm
4 x E27 x 60W



Art. 1367
ø max 20 cm H 175 cm
2 x E14 x 60W



Art. 1259
ø 20 cm H 68 cm
2 x E14 x 60W



Art. 1258
ø 20 cm H 77 cm
1 x E27 x 60W

Art. 1680/FL/KR
L 230 cm H 240 cm
Pø 80 cm
1 x E27 x 100W



Art. 1812/BI
L 230 cm H 240 cm
Pø 80 cm
1 x E27 x 100W

Art. 1813/LU
L 230 cm H 240 cm
Pø 80 cm
1 x E27 x 100W



250

Art. 1812/BI
L 230 cm H 240 cm
Pø 80 cm
1 x E27 x 100W



251

*Marina lampshades, leader
in creating customized light.*

*Фабрика Il Paralume Marina является лидером в
производстве светильников по заказу клиента.*

Art. 2102/NL
ø 80 cm H 38 cm
+100 cm Steel cable
4 x E27 x 60W

Il Paralume Marina



Art. 1227
ø 50 cm H 80 cm
2 x E27 x 40W

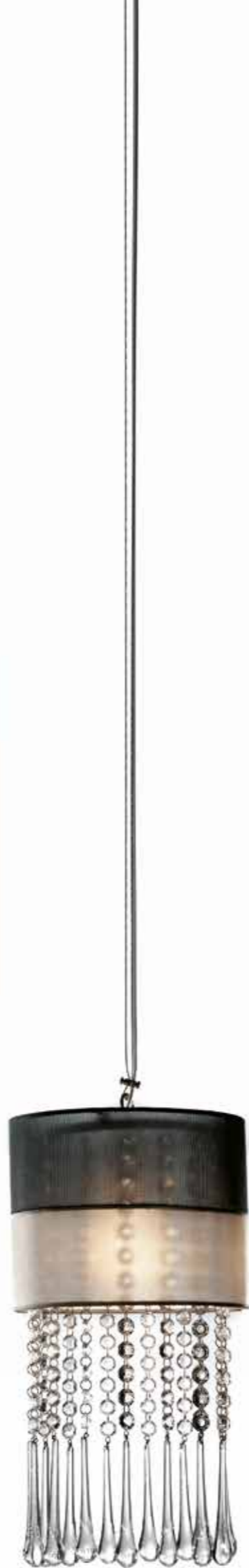

Art. 1226
ø 20 cm H 40 cm
1 x E27 x 60W



Art. 1219
ø 40 cm H 160 cm
1 x E27 x 60W



Art. 1216
ø 40 cm H 70 cm
1 x E27 x 60W

Art. 1222/A
L 25 cm H 40 cm
Sp 14 cm
1 x E27 x 40W



254



Art. 1222/G
Pø 40 cm H 70 cm
1 x E27 x 60W

Art. 1222/P
Pø 25 cm H 40 cm
1 x E27 x 40W



Art. 1222/SO
Pø 50 cm H 70/90 cm
3 x E27 x 40W



Art. 1222/FL
Pø 40 cm H 160 cm
1 x E27 x 60W

255

Il Paralume Marina

Art. 1604/P
Pø 23 cm
H 56 cm
1 x E27 x 60W



Art. 1604/FL
Pø 44 cm
H 180 cm
1 x E27 x 100W



Art. 1604/A
Pø 20 cm H 100 cm
1 x E14 x 40W

Art. 1604/G
Pø 35 cm H 70 cm
1 x E27 x 60W



Art. 1604
Pø 48 cm H 80 cm
1 x E27 x 100W



258

Art. 2191/T
L 46 cm H 51 cm Pø 40 cm
1 x E27 x Led

Art. 2191/A
L 41 cm H 16 cm Sp 20 cm
1 x E27 x Led



259



Il Paraltune Marina

Art. 2191/CH4
ø max 80 cm H 29 cm
4 x E14 x Led



Art. 2111
ø 60 cm H 38 cm
100 cm steel cable
1 x E27 x 60W



Art. 2094/NN
Pø 35 cm H 60 cm
1 x E27 x 40W



Art. 2110
ø 60 cm H 28 cm
100 cm steel cable
1 x E27 x 60W





Art. 1513
 Pø 100 cm H 44 cm
 4 x E27 x 60W

*Paralume in chiffon
 arricciato avorio.*

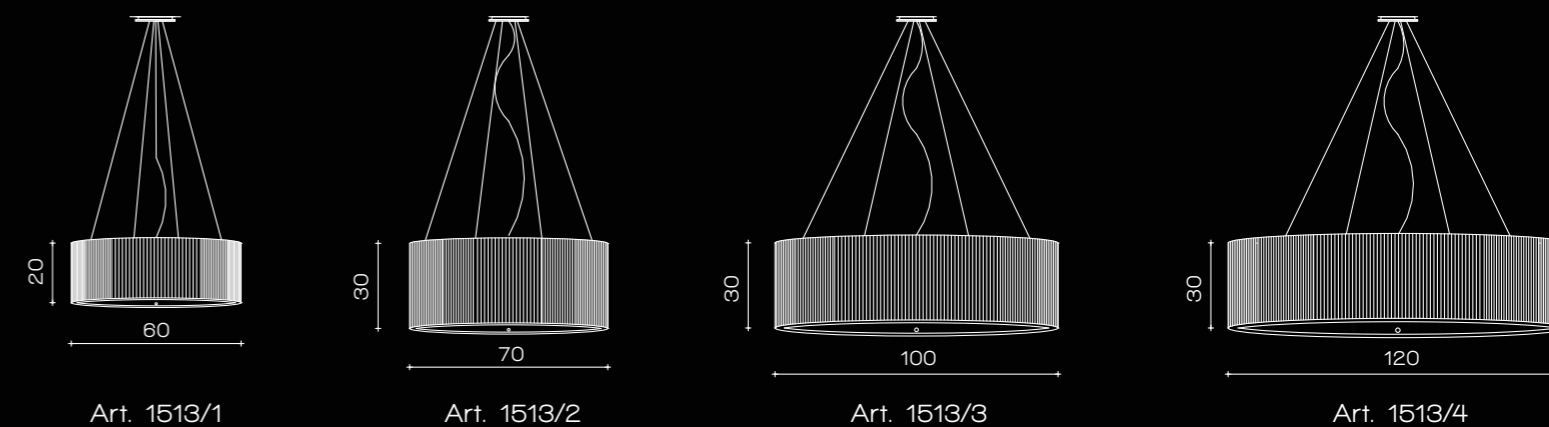

Art. 2109
 ø 80 cm H 34 cm
 1 x E27 x 60W





Art. 2190
Ø max 73 cm H 30 cm
2 x E27 x Led



Art. 2202
L 100 x 34 cm H 93 cm
4 x E27 x Led

265



Il Paralume Marina



Art. 2128/OVLU
H 62 cm ø 81 cm
8 x G9 x Led 10W

Art. 2174/CH2
ø 81 cm H 86 cm
2 x E27 x Led

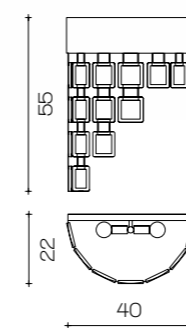

Art. 2174/A
L 40 cm H 55 cm Sp 22 cm
2 x E14 x Led

Bracelet

Paralume con bracciali quadrati di vetro di Murano e metallo in colore soft gold.

Lampshade with square bracelets in Murano glass and metal in soft gold colour.

Абажур с квадратными браслетами из муранского стекла и металла в цвете «светлое золото».



Art. 2169/A1
 H 69 cm Pø 12 cm
 Sp 15 cm
 1 x E14 x Led

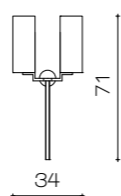

Art. 2169/A2
 L 34 cm H 71 cm
 Pø 12 cm Sp 20 cm
 2 x E14 x Led

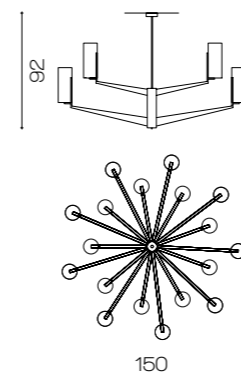

Art. 2169/CH9
 ø 150 cm H 92 cm Pø 12 cm
 18x E14 x Led

Art. 2169/CH9
 ø 112 cm H 70 cm Pø 12 cm
 9 x E14 x Led



270

Art. 2169/CH9/pyrex
ø 112 cm H 70 cm
Pø 12 cm
9 x E14 x Led



271

Art. 2187
ø 40 cm H 71 cm
1 x E27 x Led



272

Art. 1368/CH6/KR
 ø 95 cm H 60 cm Pø 16 cm
 6 x E14 x 40W



273

Il Paralume Marina

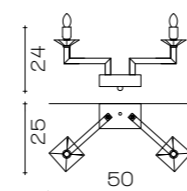

Art. 2032/A2/NL
 L 50 x 25 cm H 24 cm
 2 x E14 x 40W

Art. 2032/CH14/NL
 L 150 x 57 cm H 87 cm
 14 x E14 x 40W



Art. 1214
P. lato 32 cm
H 70 cm
1 x E27 x 60W



Art. 1214/FL
P lato 40 cm
H 180 cm
1 x E27 x 60W

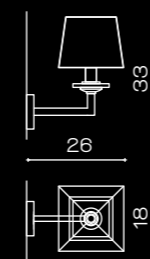

Art. 1214 Speciale A1
P lato 18 cm L 26 cm
H 33 cm Sp 26 cm
1 x E27 x 40W

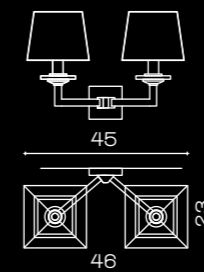

Art. 1214 Speciale A2
P lato 18 cm L 46 cm
H 33 cm Sp 23 cm
2 x E27 x 60W

Art. 1214/SO/BIS
P lato 18 cm ø max 78 cm
H max 90 cm min 75 cm
4 x E27 x 60W

276



Art. 1425/A
H 44 cm PL 44 cm Sp 18 cm
1 x E27 x 60W



Art. 1425/CH
PL 53 cm
2 x E27 x 60W H 47 cm

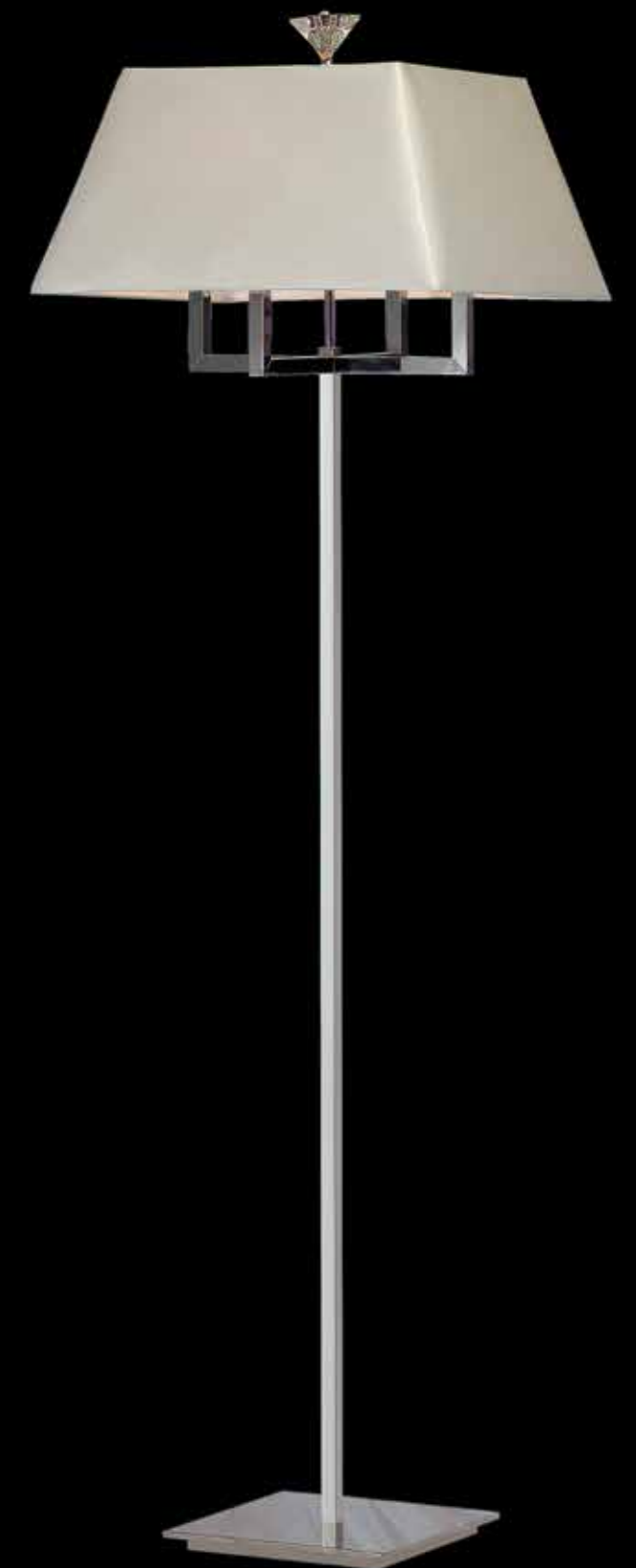

Art. 1425/FL
PL 53 cm H 180 cm
2 x E27 x 60W

*Serie in tubo di ottone cromo quadro,
paralume quadro tessuto Dedar
stampa cocodrillo avorio chiaro.*

277



Il Paralume Marina



Art. 1425/G
PL 36 cm H 50 cm
1 x E14 x 40W



Art. 1425/P
PL 23 cm H 43 cm
1 x E14 x 40W



Art. 1425 Port.
L 30 cm H 47 cm

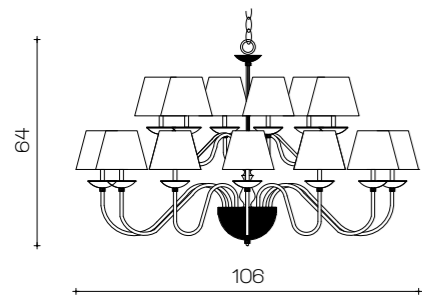

Art. 1447/CH18
 ø 106 cm H 64 cm
 Pø 16 cm
 18 x E14 x 40W

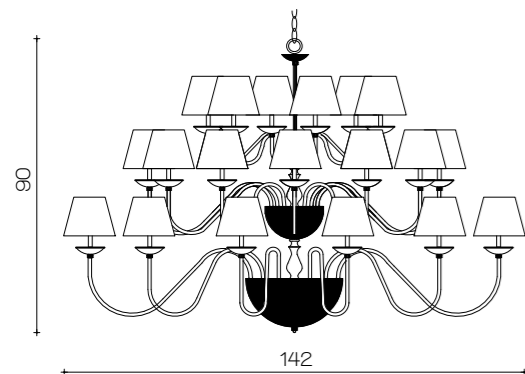

Art. 1447/CH30
 ø 142 cm H 90 cm
 Pø 16 cm
 30 x E14 x 40W

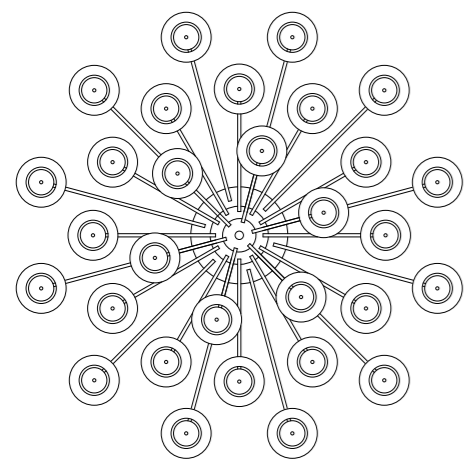

Art. 1447/A2
 L 61 cm H 40 cm
 Pø 16 cm
 2 x E14 x 40W



Art. 1570/P
 Pø 25 cm H 60 cm
 1 x E14 x 40W



Lampadario in ottone cromato e inserti Swarovski, paralume in seta pura e passamaneria in Swarovski.

Chandelier in chrome brass with Swarovski inserts, lampshade in white crumple silk with a Swarovski braid.

Люстра из хромированной латуни и с насадками из Swarovski, абажур из шелковой ткани натёртой до белого цвета и отделочными материалами из Swarovski.

Art. 1447/CH6
 ø 74 cm H 38 cm Pø 16 cm
 6 x E14 x 40W

Lampadario con inserti Swarovski, paralume in seta.



282

Art. 1457/CH5
Ø 72 cm H 70 cm PØ 16 cm
5 x E14 x 40W

*Lampada con inserti Swarovski,
paralume in seta pura bianca
lucida a pieghe piatte.*



283

Art. 1456/G
PØ 35 cm H 60 cm
1 x E27 x 60W

Art. 1456/P
PØ 18 cm H 40 cm
1 x E14 x 40W



Art. 1412
Pø 40 cm H 175 cm
1 x E27 x 60W



Art. 1411
Pø 25 cm H 65 cm
1 x E27 x 60W



Art. 1566/KR
P ovale 40x27 H 83 cm
1 x E27 x 60W
Nappa N.14

*Lampada in cristallo fiorentino molato a mano,
paralume in tessuto a pois argento.*

*Paralume in seta
avorio a pieghe piatte.*

Art. 1428
ø 18 cm H 28 cm
1 x E14 x 40W



*Serie in ottone oro vecchio con inserti in
cristallo, paralume in seta.*

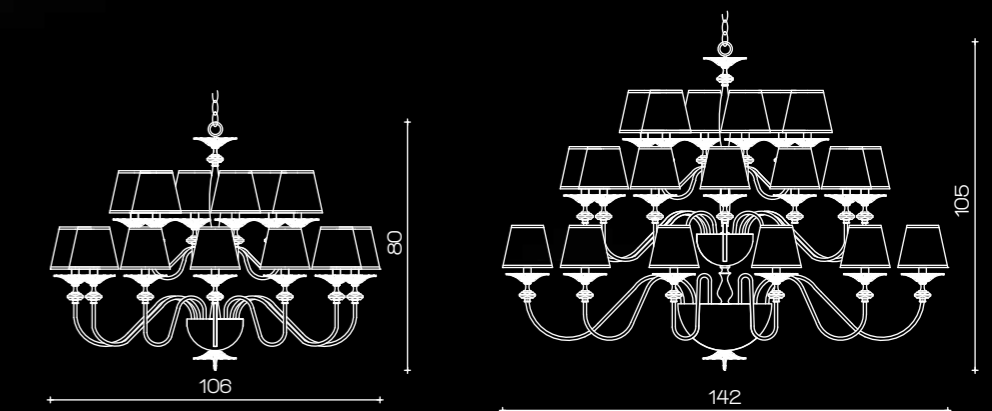

Art. 1502/CH5
ø 72 cm H 70 cm Pø 16 cm
5 x E14 x 40W

Art. 1502/CH18
ø 106 cm H 80 cm Pø 16 cm
18 x E14 x 40W

Art. 1502/CH30
ø 142 cm H 105 cm Pø 16 cm
30 x E14 x 40W

Art. 1502/G
Pø 35 cm H 70 cm
1 x E27 x 40W

Art. 1502/P
ø 25 cm H 45 cm
1 x E14 x 40W





Art. 1091/KR
 Pø 22 cm H 48 cm
 1 x E14 x 40W

Art. 1092/KR
 Pø 30 cm H 68 cm
 1 x E14 x 60W



Art. 1091/OVAM
 Pø 22 cm H 48 cm
 1 x E14 x 40W

Art. 1092/OVAM
 Pø 30 cm H 68 cm
 1 x E14 x 60W



Art. 1164 KR
 Pø 50 cm H 175 cm
 1 x E27 x 60W





Art. 2095/NL
L 30 cm H 71 cm Sp max 10 cm
1 x E27 x Led 10W



Art. 2096/BI
L 10 cm H 60 cm Sp 6 cm
2 x G9 x Led 10W

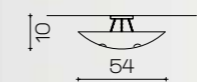

Art. 2101/P/LU
Ø 54 cm H 10 cm
H tot. 20 cm
2 x E27 x Led 7W

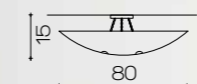

Art. 2101/G/LU
Ø 80 cm H 15 cm
H tot. 25 cm
4 x E27 x Led 7W



Art. 2097/BI
L 18 cm H 55 cm Sp 10 cm
2 x E14 x Led 5W



Art. 2192/BR
L 100 cm H max 11 cm Sp 3 cm
Led 28W 4000 Lm 3000°K



292

Art. 2192/BI
L 100 cm H max 11 cm Sp 3 cm
Led 28W 4000 Lm 3000°K

Art. 2192/OV
L 100 cm H max 11 cm Sp 3 cm
Led 28W 4000 Lm 3000°K



293



Il Paralume Marina

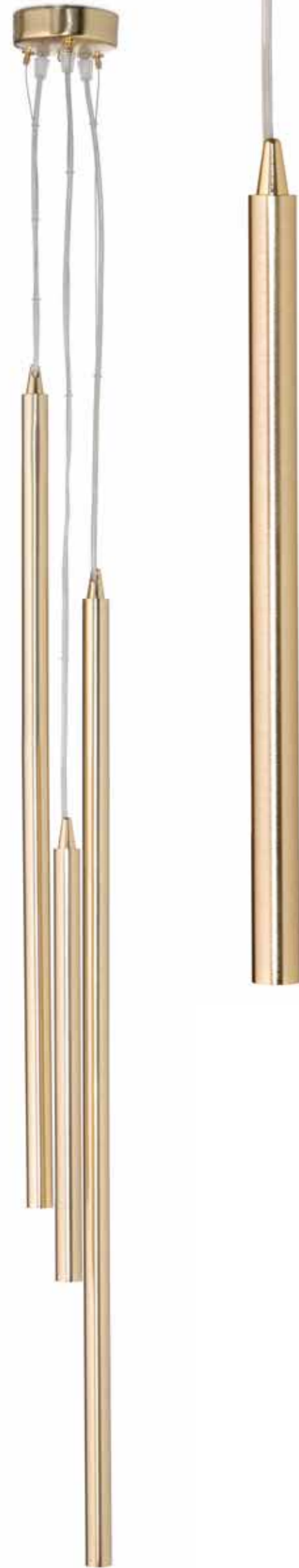

Art. 2138/CH1
 ø 10 cm H 100 cm Kg 4
 1 x G9 x Led



Art. 2139/A2
 ø 8 cm H 25 cm
 Sp 12 cm kg 4
 2 x GU10 x Led



Art. 2139/CH1
 ø 8 cm H 80 cm Kg 6
 metal tube ø 8 cm x H 29 cm
 1 x GU10 x Led

Art. 2140/CH1
 ø 8 cm H 100 cm Kg 6
 metal tube ø 8 cm x H 64 cm
 1 x GU10 x Led

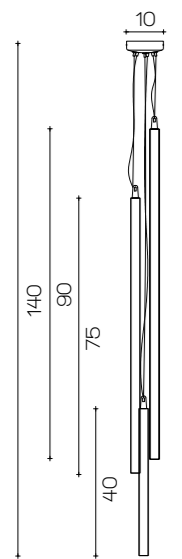

Art. 2138/CH3
 ø 10 cm Kg 8
 H 140 cm
 3 x G9 x Led

Art. 2144
 ø 15 cm H 100 cm Kg 5
 with Glass element 56 cm
 1 x G9 x Led



Art. 2142
 ø 19 cm H 160 cm
 Kg 25
 1 x E27 x Led



Art. 2143
 ø 15 cm H 100 cm
 with 50 cm steel cable
 1 x E14 x Led



Art. 2088/NL
 Pø 25 cm
 H 80 cm
 1 x E27 x 60W



Art. 2141
 ø 19 cm H 160 cm
 Kg 25
 1 x E27 x Led





Art. 2089/NL
Pø 25 cm H 80 cm
1 x E27 x 60W



Art. 2087/NL
Pø 30 cm H 85 cm
1 x E27 x 60W



Art. 2189/GR
ø 40 cm H 78 cm
1 x E27 x Led



Art. 2189/VE
ø 40 cm H 78 cm
1 x E27 x Led

Art. 2189/TR
ø 40 cm H 78 cm
1 x E27 x Led

Art. 2189/AM
ø 40 cm H 78 cm
1 x E27 x Led



Art. 2188/VE
Ø 30 cm H 85 cm
1 x E27 x Led



Art. 2188TR
Ø 30 cm H 85 cm
1 x E27 x Led

303



Il Paralume Marina

304



Art. 2186/GR
ø 50 cm H 82 cm
1 x E27 x Led

305



Art. 2186
ø 50 cm H 82 cm
1 x E27 x Led

Il Paralume Marina



Art. 1952/LU/AM
 Pø 30 cm H 77 cm
 1 x E27 x 60W

Art. 1952/NL/GR
 Pø 30 cm H 77 cm
 1 x E27 x 60W

Art. 1952/NL/BI
 Pø 30 cm H 77 cm
 1 x E27 x 60W



Art. 1943/NN/AM
 Pø 35 cm H 66 cm
 1 x E27 x 60W

Art. 1944/NN/GR
 Pø 35 cm H 66 cm
 1 x E27 x 60W



Art. 1950/BI
 Pø 40 cm H 74 cm
 1 x E27 x 60W
 RAL9016



Art. 1945/BI
 Pø 48 cm H 74 cm
 1 x E27 x 60W
 RAL9016

Art. 1945/NN
 Pø 48 cm H 74 cm
 1 x E27 x 60W



Art. 1951/LU/TR
Pø 38 cm H 98 cm
1 x E27 x 60W



Art. 1951/LU/RO
Pø 38 cm H 98 cm
1 x E27 x 60W
Nappa N.47



Art. 1891
H 80 cm Pø 45 cm
1 x E27 x 60W



Art. 2086/LU
Pø 25 cm H 69 cm
1 x E27 x 60W



Art. 2086/NL
Pø 25 cm H 69 cm
1 x E27 x 60W



Art. 1954/G
Pø 29 cm H 92 cm
1 x E27 x 60W

Art. 1954/P
Pø 23 cm H 67 cm
1 x E27 x 40W



314

Art. 2092/LU
Pø 35 cm H 78 cm
1 x E27 x 60W



Art. 2091/LU
Pø 35 cm H 78 cm
1 x E27 x 60W



315

Art. 2090/NN
Pø 35 cm H 78 cm
1 x E27 x 60W



Art. 1892
Pø 45 cm H 126 cm
1 x E27 x 60W



Art. 1717/G
P Lato 45 x 45 cm H 98 cm
1 x E27 x 60W

Art. 1717/P
Pø 40 cm H 71 cm
1 x E27 x 60W

Point Lights with gold-leaf
Murano Glass drop.

Available colours:
Blue, Green, Gold

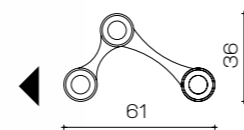

Art. 2197/BI/GOLD
L 61 x 36 cm
H 3 cm H tot 25 cm
G x 53 3 x 11W Led
ø int. 75 mm

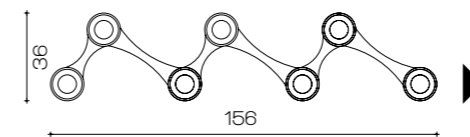

Art. 2200/BI/GOLD
L 156 x 36 cm
H 3 cm H tot 25 cm
G x 53 7 x 11W Led
ø int. 75 mm

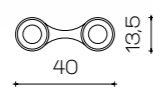

Art. 2193/BI
L 40 x 13,5 cm
H 3 cm H tot 25 cm
G x 53 2 x 11W Led
ø int. 75 mm

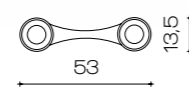

Art. 2194/BI
L 53 x 13,5 cm
H 3 cm H tot 25 cm
G x 53 2 x 11W Led
ø int. 75 mm

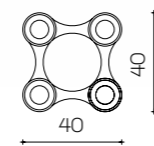

Art. 2196/BI
L 40 x 40 cm
H 3 cm H tot 25 cm
G x 53 4 x 11W Led
ø int. 75 mm

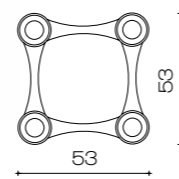

Art. 2195/BI
L 53 x 53 cm
H 3 cm H tot 25 cm
G x 53 4 x 11W Led
ø int. 75 mm

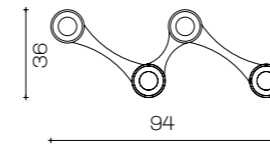

Art. 2198/BI
L 94 x 36 cm
H 3 cm H tot 25 cm
G x 53 4 x 11W Led
ø int. 75 mm

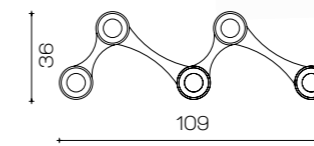

Art. 2199/BI
L 109 x 36 cm
H 3 cm H tot 25 cm
G x 53 5 x 11W Led
ø int. 75 mm



2



4



6

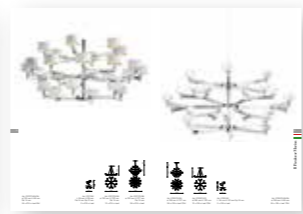

8

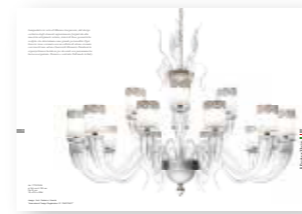

70



72

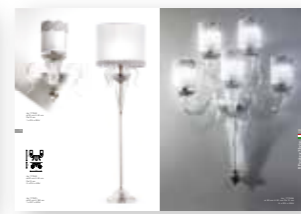

74



76



78



10



12



14

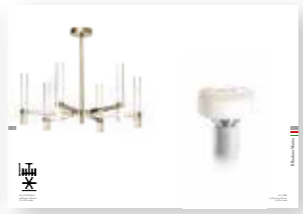

16



18



80



82



84



86

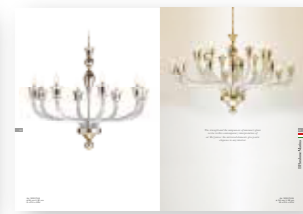

88



20



22



24



26

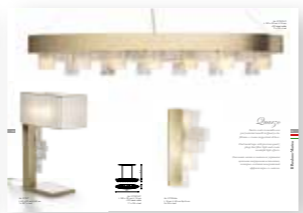

28

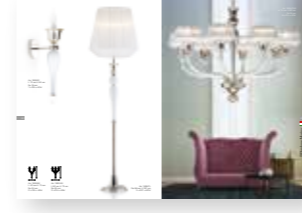

90



92



94



96



98



30

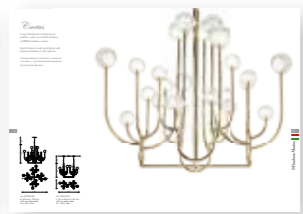

32



34



36

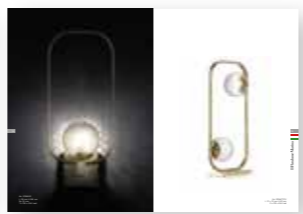

38



100



102



104



106

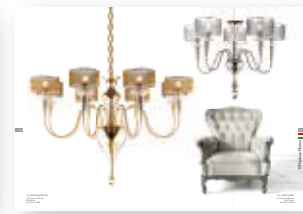

108



40



42

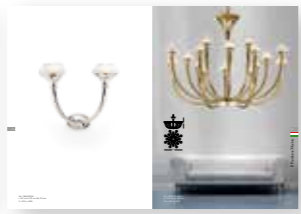

44

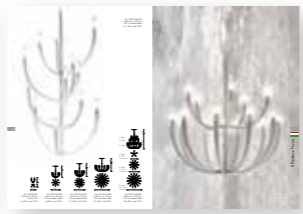

46



48



110



112

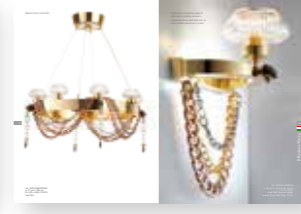

114



116



118



50



52



54



56



58



120



122



124

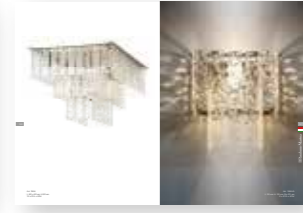

126



128

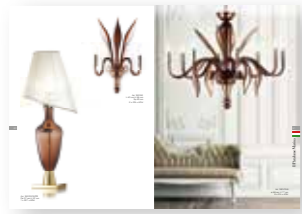

60



62

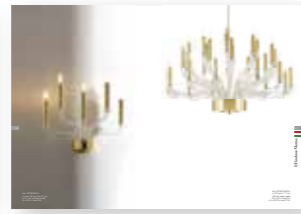

64



66



68



130



132



134

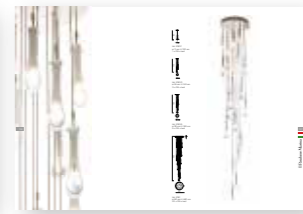

136



138



140



142

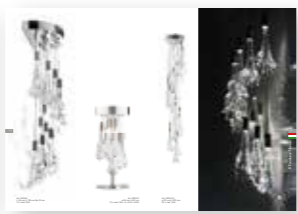

144



146



148



210



212



214



216



218



150

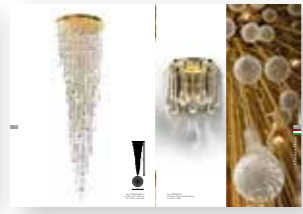

152



154



156

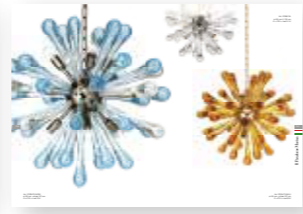

158

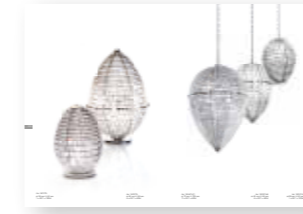

220



222

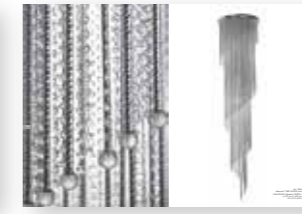

224

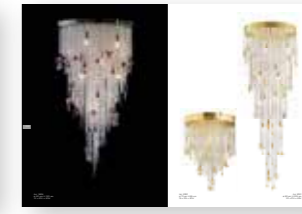

226



228



160

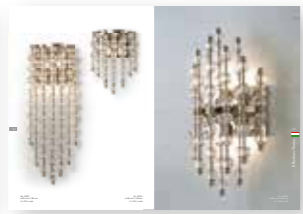

162



164



166



168



230

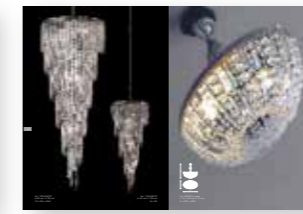

232



234



236



238



170



172



174



176



178



240



242



244



246



248



180

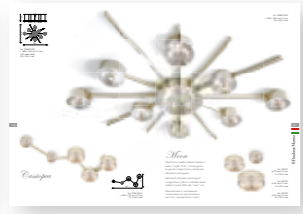

182



184

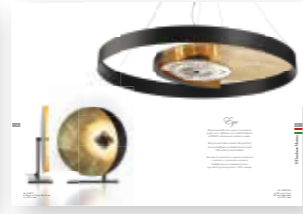

186



188



250

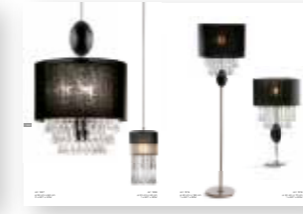

252



254

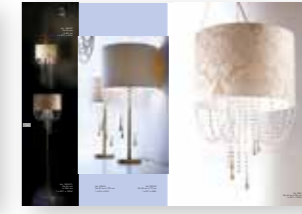

256



258



190



192



194

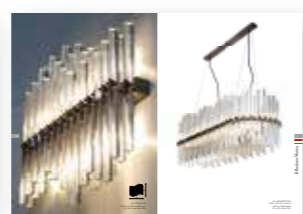

196



198



260



262



264



266



268

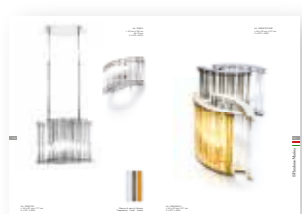

200

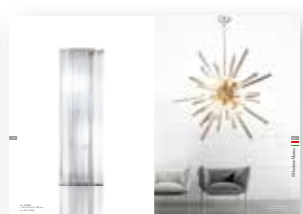

202



204

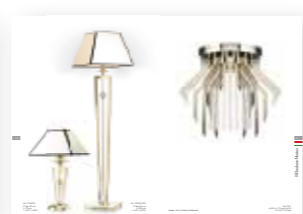

206



208



270



272

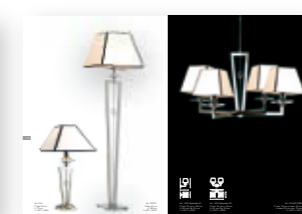

274



276



278



280 282 284 286 288



290 292 294 296 298



300 302 304 306 308

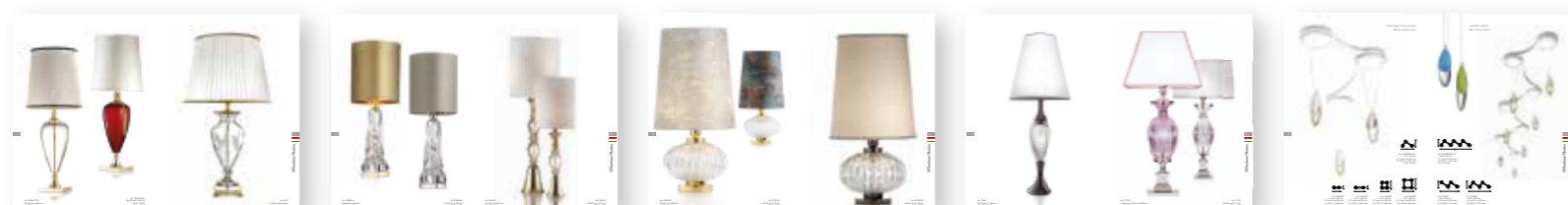

310 312 314 316 318



326

Il Paralume Marina

Classic Lighting



Art. 1953/LU/VI
 Pø 40 cm H 120 cm
 1 x E27 x 60W
 Nappa N.46

325

Il Paralume Marina



MADE WITH
SWAROVSKI
ELEMENTS

SWAROVSKI® e un marchio registrato



Atelier del Paralume
Atelier lampshades
Ателье абажуров



Fusione in Ottone
Brass casting
Литье латуни



Vetro di Murano
Murano glass
Муранское стекло



Cristallo Italiano
Italian Crystal
Итальянский хрусталь

Il Paralume Marina

La Passione, la dedizione e la cura attentissima del dettaglio, animano l'atelier della Signora Marina. Moderne tecnologie affiancano lavorazioni manuali tradizionali per ottenere un prodotto totalmente esclusivo e di eccellenza, 100% Made in Italy. La continua ricerca e innovazione di tessuti e passamanerie rende Il Paralume Marina Leader nel creare oggetti su misura.

Passion, dedication and careful attention to detail bring to life the workshop of Mrs. Marina. Modern technologies alongside traditional manual processes obtain a product totally unique and of high quality, 100% Made in Italy. The continuous research and innovation of fabrics and trimmings makes Il Paralume Marina, the Leader in creating custom-made products.

В ателье госпожи Марины царят Вдохновение, Страсть, Самоотдача и высочайшее Внимание к деталям. Современные технологии идут рука об руку с традиционными техниками рукоделия, воплощаясь в эксклюзивном продукте, 100% сделанном в Италии. Постоянные исследования и применения последних инноваций в тканях и окантовках делают Il Paralume Marina лидером среди производителей персонализированных изделий.

La fusione in terra dell'ottone è un'arte antica, che ancora oggi sa emozionare. La pressofusione crea oggetti di eccellenza e di altissima qualità sinonimi di lusso ed eleganza esclusivamente made in Italy. Fondiamo metallo trasformando l'idea di architetti e designer in oggetti esclusivi, dal prototipo allo stampo, al prodotto finito.

Brass sand casting is an ancient art, which still continues to excite. Casting creates objects of excellence and of the highest quality, demonstrating luxury and elegance exclusively made in Italy. We base metal transformation on the ideas of exclusive product architects and designers, from the prototype, to the mould, to the finished product.

Литье латуни «в землю» - это античное искусство, которое и сегодня способно вызывать эмоции. Литье создает предметы высокого качества с особым благородным шармом, присущим роскошным интерьерам, сделанным исключительно в Италии. Мы плавим металл, трансформируя идею архитектора и дизайнера в эксклюзивные предметы: от прототипа - к штампу - до законченного продукта

Maestri artigiani che tramandano l'arte antica muranese garantiscono un prodotto di classe di alta gamma e qualità indiscutibili. La produzione interamente artigianale e l'uso di tecniche raffinate rendono ogni oggetto un pezzo unico. L'esperienza dei maestri per noi è un punto di partenza per creare oggetti attuali di arredamento e di emozione. La forza del Paralume Marina è la qualità eccellente e la flessibilità nell'assecondare le richieste di un mercato internazionale sempre in evoluzione.

Master craftsmen who hand down the ancient art of Murano guarantee a high-class product of unquestionable quality. Total handmade production and the use of sophisticated techniques make each product unique. The experience of the master craftsmen is a starting point for us to create real pieces of furniture of emotion. The strength of Il Paralume Marina is the excellent quality and flexibility to adapt to the demands of an ever changing market.

Мастера-ремесленники передают античное искусство муранского стекла из поколения в поколение, что гарантирует их изделиям высочайший уровень качества. Изготовление вручную и использование искусных техник делают каждое их творение уникальным и неповторимым. Опыт Мастеров является для нас отправной точкой для создания актуальных предметов интерьера с ярким эмоциональным оттенком. Сильной стороной Il Paralume Marina является безупречное качество и гибкость в подходе к требованиям динамичного и такого разнообразного международного рынка.

Il cristallo è orgogliosamente solo italiano. Si ottiene fondendo in appositi forni a temperatura elevata, superiore a 1400°, utilizzando materie prime di qualità superiore si ottiene un prodotto con oltre il 24% di PbO, che conferisce una luminosità e trasparenza indiscutibili. La lavorazione del cristallo è eseguita artigianalmente; viene soffiato a bocca e le incisioni sono eseguite interamente a mano per cui ogni oggetto diviene "Objet d'Arte".

Paralume Marina proudly uses only Italian crystal. It is made by melting in special high temperature furnaces, exceeding 1400°, using optimum quality raw materials a product is obtained with over 24% of PbO, which gives an undeniable brightness and clarity. The processing of crystal is carried out by hand; it is blown and the incisions are made entirely by hand so that every object becomes an "Objet d'art".

Исключительно лучший итальянский хрусталь является нашей гордостью и отличительной чертой. Его получают посредством плавки в специальных печах при высокой температуре, превышающей 1400°, используя материалы лучшего качества. Это позволяет получить продукт с процентом свинца в составе в 24% и выше, что придает изделиям безупречную прозрачность и яркость. Обработка хрусталя проходит вручную: его выдувают, а затем гравировать полностью вручную, что гарантирует каждому изделию титул Произведения Искусства.

Project

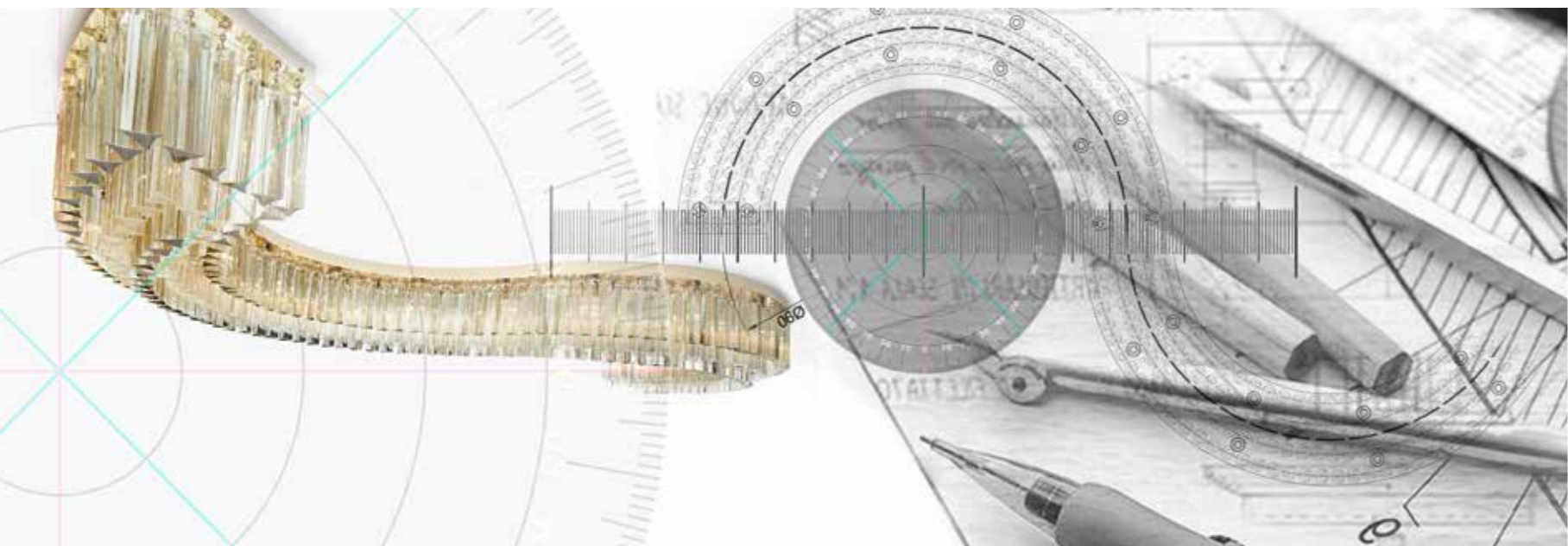

Ogni progetto è una sfida che affrontiamo con serietà e passione, dedizione al cliente e cura nei dettagli maniacale. Il Paralume Marina con la sua esperienza e con il suo team interno di designer e ingegneri, garantisce un servizio esclusivo ai professionisti che desiderano utilizzare soluzioni di illuminazione decorativa nei loro progetti, proponendo alternative stilistiche, tecniche ed economiche adeguate alla richieste della committenza.

Each project is a challenge that we approach with seriousness and passion, dedication to the customer and meticulous attention to detail. Il Paralume Marina with its experience and in-house team of designers and engineers, guarantees an exclusive service for users who wish to use decorative lighting solutions in their projects, offering stylistic, technical and inexpensive options adapted to the demand of the client.

Каждый проект – это вызов, который мы принимаем с максимальной серьезностью и страстью, преданностью клиенту и маниакальным вниманием к деталям. Il Paralume Marina со своим опытом и собственной сплоченной командой дизайнеров и инженеров, гарантирует эксклюзивный сервис для профессионалов, которые желают включить в собственные проекты смелые решения по декоративному освещению, предлагая стилистические, технические и экономические альтернативы, оптимально адаптированные под запрос Заказчика.

Il Paralume Marina

Contemporary Lighting

Design: Arch. Federica Vicentini
Proget Director: Thomas Simoncello
Printing: Girardi Print Factory

Tutte le misure sono indicate in cm
H = altezza, L = larghezza,
∅ = diametro, P∅ = diametro del paralume,
Sp = sporgenza.

Tutti i diritti riservati.
Sono vietate la pubblicazione la trasmissione la fotocopiatura e qualsiasi altra forma di duplicazione o riproduzione, parziali e totali dei testi e della grafica qui contenuti, senza il preventivo consenso scritto della ditta il Paralume Marina. Il produttore si riserva il diritto di introdurre modifiche tecnologiche. Il produttore declina qualsiasi responsabilità per eventuali errori di stampa.

Il Paralume Marina s.r.l.
Vicolo Col Beretta, 6
36022 San Zeno di Cassola (VI) ITALY

Tel +39 0424 33 042
Fax +39 0424 511 817

www.ilparalumemarina.com
info@ilparalumemarina.it
Skype: ilparalumemarina

Made in Italy

Since 1987

Il Paralume Marina

MADE IN ITALY
Since 1987

ilparalumemarina.it