



lo i G S K



Like Niagara falls , li **K**e a much desired luxury,
Like a crystal waterfall which flows from the ceiling.

Like a mountain of ice which gle **A**ms mysteriously.
Like subdued candlelight.

Like enthusiasm which has the courage
to pave new ways without looking back.
Like wisdom which stems from tradition,

interpreting the **k****E**y to the future.

Like Kaleido, a new collection with striking features

launched by Italamp by draw **I**ng on the best resources
of our experience, knowledge of tradition, technology

and **D**esign.

We can't touch the light, but light is a special touch
which evokes feelings and ambience.

Every light is its **O**wn light.
A world opens up in every Kaleido composition.

Come in, feel it, live it.

Come le cascate del **N****I**agara.
Come un lusso che si rivela dopo tanta attesa.
Come la complicità di un chiarore di candela.
Come una fontana di cristalli che sgorga dal soffitto.

Come una mon **T**agna di ghiaccio che manda bagliori
misteriosi.
Come l'energia di un progetto cha ha il coraggio di **A**prire
strade nuove senza voltarsi indietro.

Come l'intel **L**igenza di una visione che fa tesoro della
tradizione, interpretandol **A** in chiave di futuro.
Come Kaleido, una nuova collezione dai tratti sorprendenti

lanciata da Italamp attingendo alle **M**igliori risorse
della nostra esperienza, conoscenza della tradizione,
della tecnologia e del design.
La luce non si può toccare ma è un tocco che fa **P**ulsare
sentimenti e ambienti.

Ogni luce è una luce a sé.
In ogni composizione di Kaleido si apre un mondo.

Entraci. Attraversalo. Vivilo.



Exclusive high-end lighting, designed and made in Italy, since 1975
Italamp develops and manufactures products entirely in Italy that stand out for their distinct personality and for the use of traditional techniques that guarantee the highest quality and uniqueness of each creation.

Azienda leader nel design dell'illuminazione Made in Italy, dal 1975.
Italamp sviluppa e realizza interamente in Italia prodotti che si distinguono per la spiccata personalità e per l'utilizzo di tecniche della tradizione che garantiscono la massima qualità e l'unicità di ogni creazione.



Our products are cared for in every detail, the refraction of light is a key aspect in creating an elegant atmosphere that can give off a timeless appeal.

I nostri prodotti vengono curati in ogni dettaglio, la rifrazione della luce è un aspetto fondamentale per creare un'atmosfera elegante, in grado di sprigionare un fascino sempre attuale.

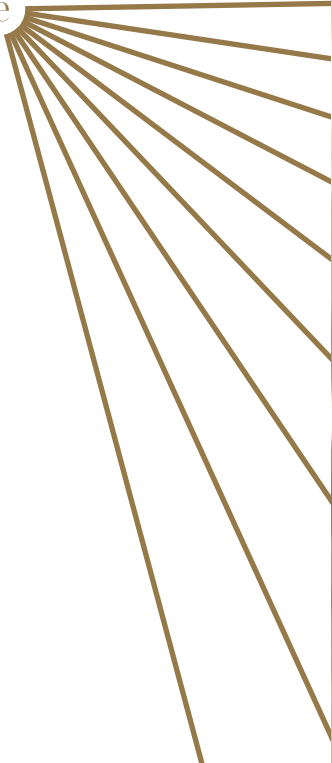



Our products are embellished with unique glass and crystal.
The craftsmanship always considers the result to be achieved:
the transparency, the brilliance, the grace of a product
that has crossed ages and histories, sought after for its beauty
and its nobility of living as a natural material.

I nostri prodotti sono impreziositi da vetri e cristalli unici.
La lavorazione artigianale tiene sempre conto del risultato a cui si deve arrivare:
la trasparenza, la brillantezza, la grazia di un prodotto
che ha attraversato epoche e storie, ricercato per la sua bellezza
e per la sua nobiltà di materia viva e naturale.



Where the **art** of glass
meets **design**

Dove l'**arte** del vetro
incontra il **design**

Kaleido Elements



Alyssa



Neda



Dalia



Ori



Flora



Pluma



Lila



Reva



Lisia



Sella



Marina

Light on ceiling
Luce a soffitto



Alyssa



Neda



Dalia



Ori



Flora



Pluma



Lila



Reva



Lisia



Sella



Marina

Light on leaf
Luce sulla foglia



Dalia



Ori



Reva



Sella

Index Kaleido

Lila

pag. 131

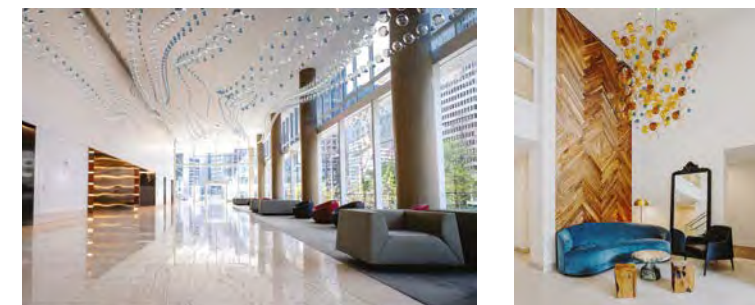

Alyssa

pag. 89

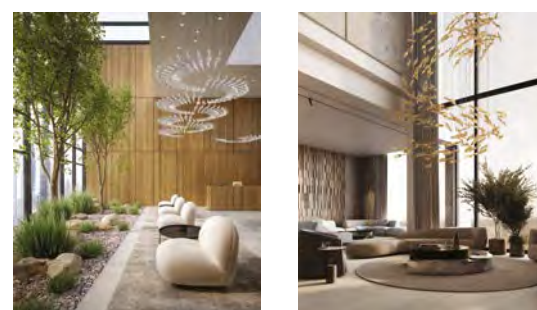

Lisia

pag. 123

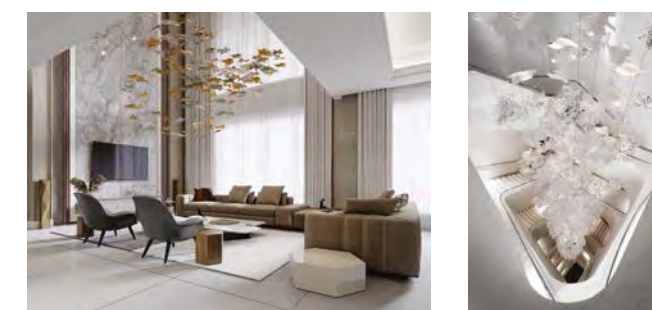

Dalia

pag. 109

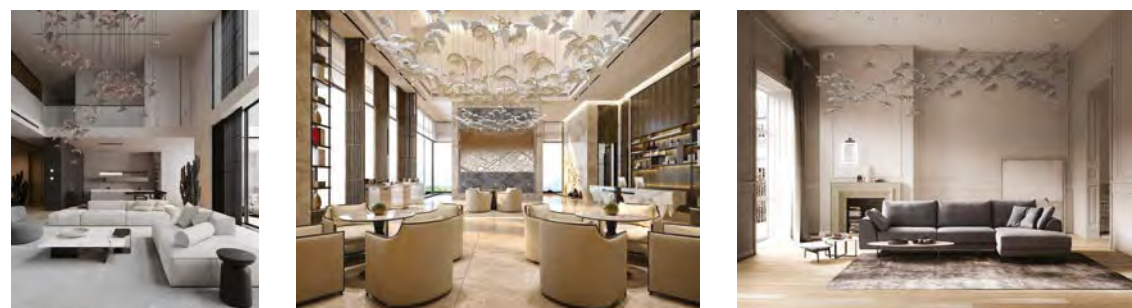

Marina

pag. 99

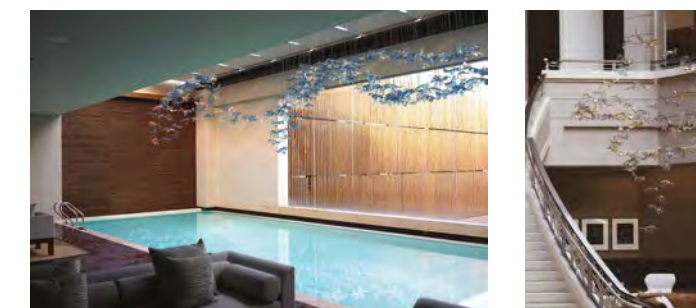

Flora

pag. 77

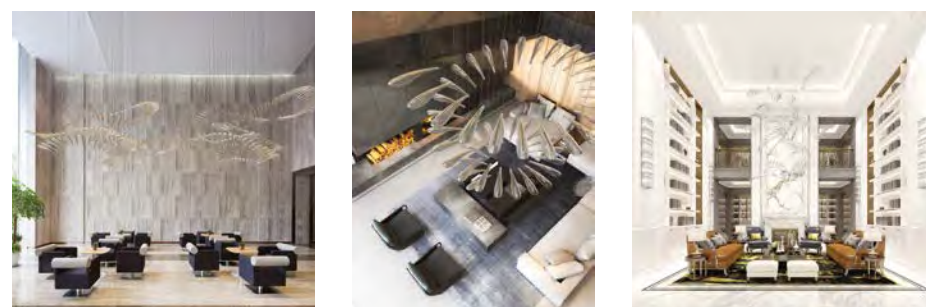

Neda

pag. 55

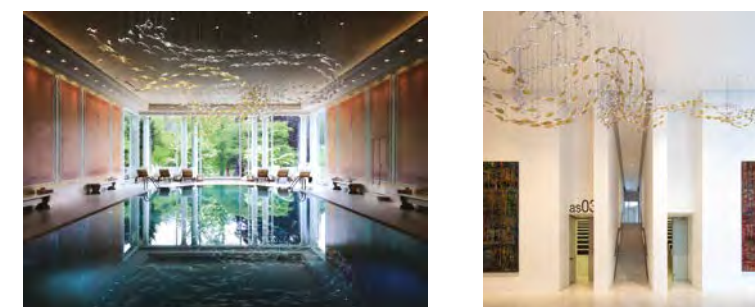

Index Kaleido

pag. 65



Ori

pag. 33



Pluma

pag. 49



Kaleido

pag. 141

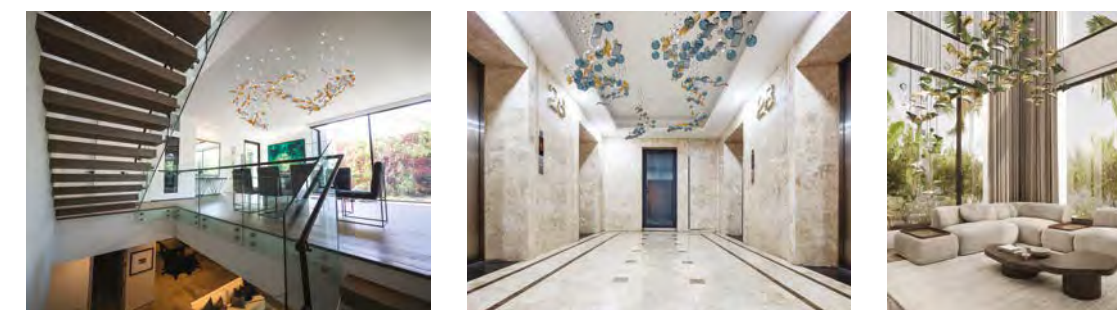

Reva

pag. 23

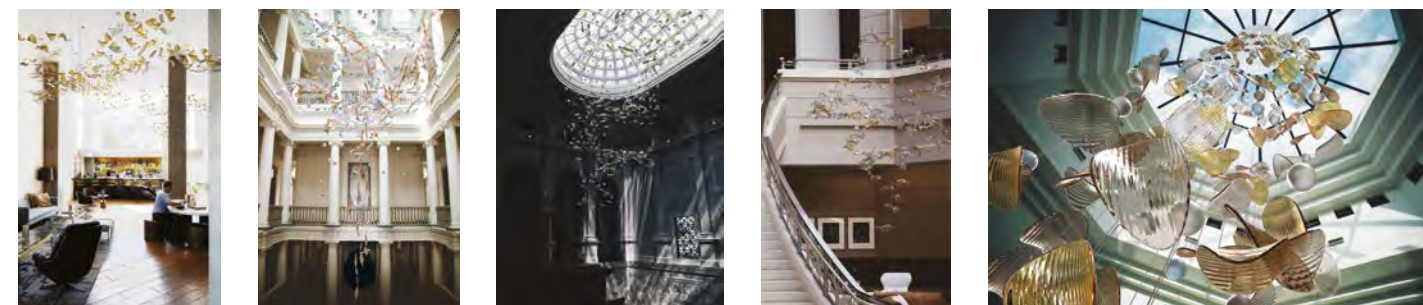
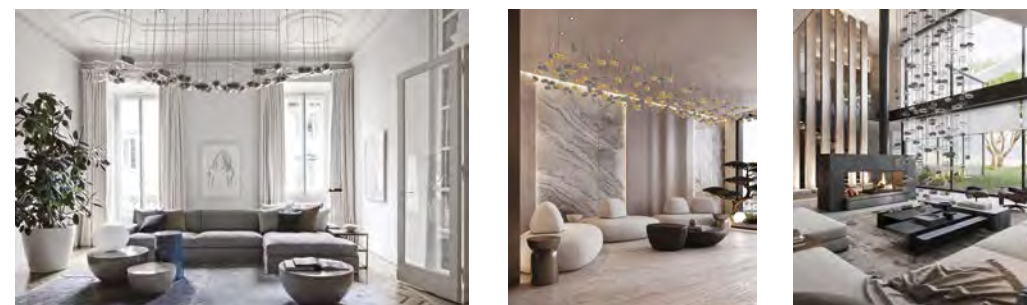



Kaleido Suggestions

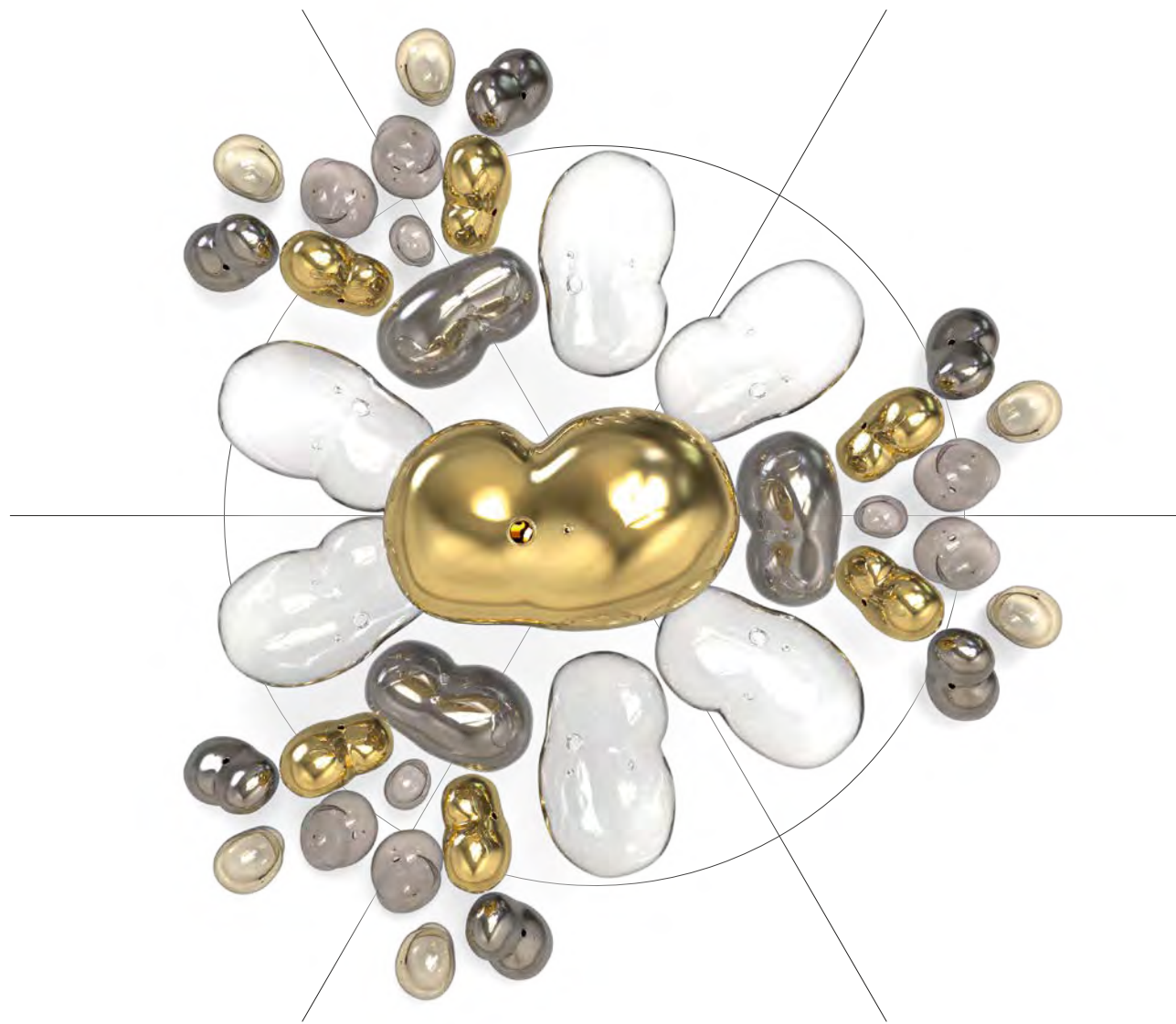

Reva

Specification

Reva

Design Italamp Studio



Available with led inside
Disponibile con luce sulla foglia

Available finishes Finiture disponibili

- | | |
|---------------------------|----------------|
| 1. Gold Metal Coating | 1. Oro |
| 2. Titanium Metal Coating | 2. Titanio |
| 3. Clear | 3. Trasparente |
| 4. Smoked | 4. Fumè |

The compositions are suggestions to stimulate the imagination and creativity of the viewer, a concrete tool in the service of design. Please be advised that the color of the glass varies slightly from what is shown in the pictures. All products in the ITALAMP collections are carefully created using craft techniques, all glass components are handmade and for this reason the single element shape might vary slightly. These variations are not imperfections but characteristic peculiarities of the production process.

Le composizioni sono suggestioni per stimolare la fantasia e la creatività del cliente, uno strumento concreto al servizio del design. Si prega di notare che il colore del vetro varia leggermente da quello mostrato nelle immagini. Tutti i prodotti delle collezioni ITALAMP sono realizzati con cura utilizzando tecniche artigianali, tutti i componenti in vetro sono realizzati a mano e per questo motivo la forma del singolo elemento potrebbe variare leggermente. Queste variazioni non sono imperfezioni ma caratteristiche peculiarità del processo produttivo.

110 mm - 4,3" inch

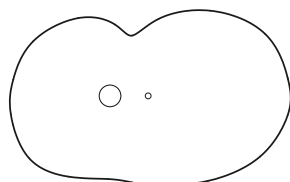

85 mm - 3,3" inch

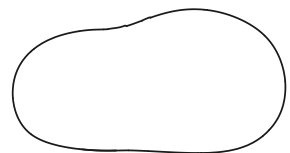

170 mm - 6,7" inch

Spotted - Recessed



3W 3000K CRI>90 240lm
Beam 36°

9W 3000K CRI>80 1200lm
Beam 40°

Spotted - Trimless



3W 3000K CRI>90 240lm
Beam 36°

12W 3000K CRI>90 1100lm
Beam 40°

Microled - On leaf 1-2



0,28W 3000K CRI>80 35lm
Beam 120°

1.



2.



3.



4.





Reva

T774



W 273 cm - D 80 cm - h¹ 37 cm . W 107" - D 31" - h¹ 15"
8 Spotted 9W - 3000K - 31 Microled 0,28W - 3000K



Reva

T774/A



W 741 cm - D 183 cm - h¹ 56 cm . W 292" - D 72" - h¹ 20"
31 Spotted 9W - 3000K - 105 Microled 0,28W - 3000K



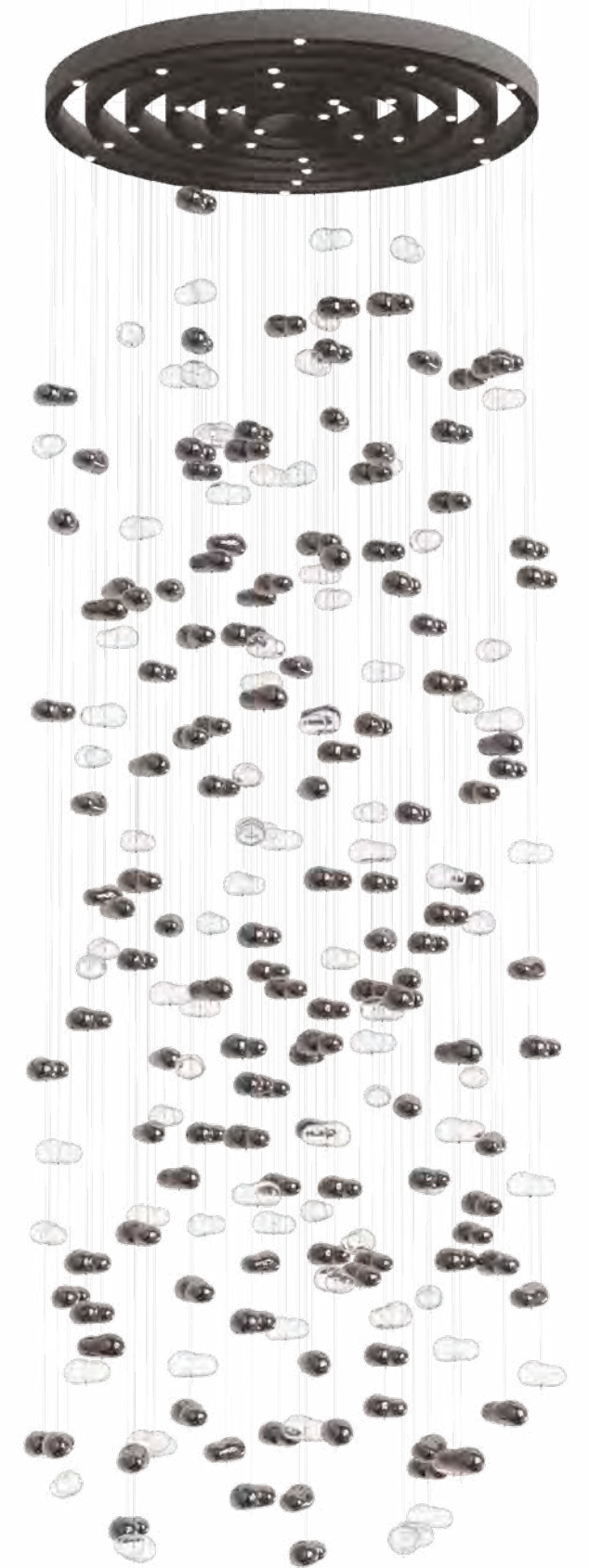

Reva

T774/B



W 160 cm - D 160 cm - h¹ 473 cm . W 63" - D 63" - h¹ 186"
21 Spotled 9W - 3000K - 84 Microled 0,28W - 3000K



Ori

Specification Ori

Design S. Traverso - R. Nardi



Available with led inside
Disponibile con luce sulla foglia

Available finishes Finiture disponibili

- | | |
|------------------------|----------------------------|
| 1. White | 1. Bianco |
| 2. White + Gold | 2. Bianco + Oro |
| 3. White + Titanium | 3. Bianco + Titanio |
| 4. White + Gold leaf | 4. Bianco + Foglia oro |
| 5. White + Silver leaf | 5. Bianco + Foglia argento |

The compositions are suggestions to stimulate the imagination and creativity of the viewer, a concrete tool in the service of design. Please be advised that the color of the glass varies slightly from what is shown in the pictures. All products in the ITALAMP collections are carefully created using craft techniques, all glass components are handmade and for this reason the single element shape might vary slightly. These variations are not imperfections but characteristic peculiarities of the production process.

Le composizioni sono suggestioni per stimolare la fantasia e la creatività del cliente, uno strumento concreto al servizio del design. Si prega di notare che il colore del vetro varia leggermente da quello mostrato nelle immagini. Tutti i prodotti delle collezioni ITALAMP sono realizzati con cura utilizzando tecniche artigianali, tutti i componenti in vetro sono realizzati a mano e per questo motivo la forma del singolo elemento potrebbe variare leggermente. Queste variazioni non sono imperfezioni ma caratteristiche peculiarità del processo produttivo.

210 mm - 8,3" inch

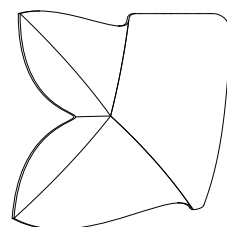

110 mm - 4,3 inch

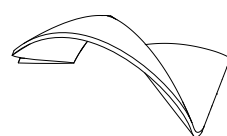

190 mm - 7,5" inch

weight 0,35 Kg - 0,8 lbs

Spotted - Recessed



3W 3000K CRI>90 240lm
Beam 36°



9W 3000K CRI>80 1200lm
Beam 40°

Spotted - Trimless



3W 3000K CRI>90 240lm
Beam 36°



12W 3000K CRI>90 1100lm
Beam 40°

Microled - On leaf



0,28W 3000K CRI>80 35lm
Beam 120°





Ori

T766/D



W 339 cm - D 139 cm - h¹ 137 cm . W 133" - D 55" - h¹ 54"
19 Spotled 9W - 3000K - 41 Microled 0,28W - 3000K

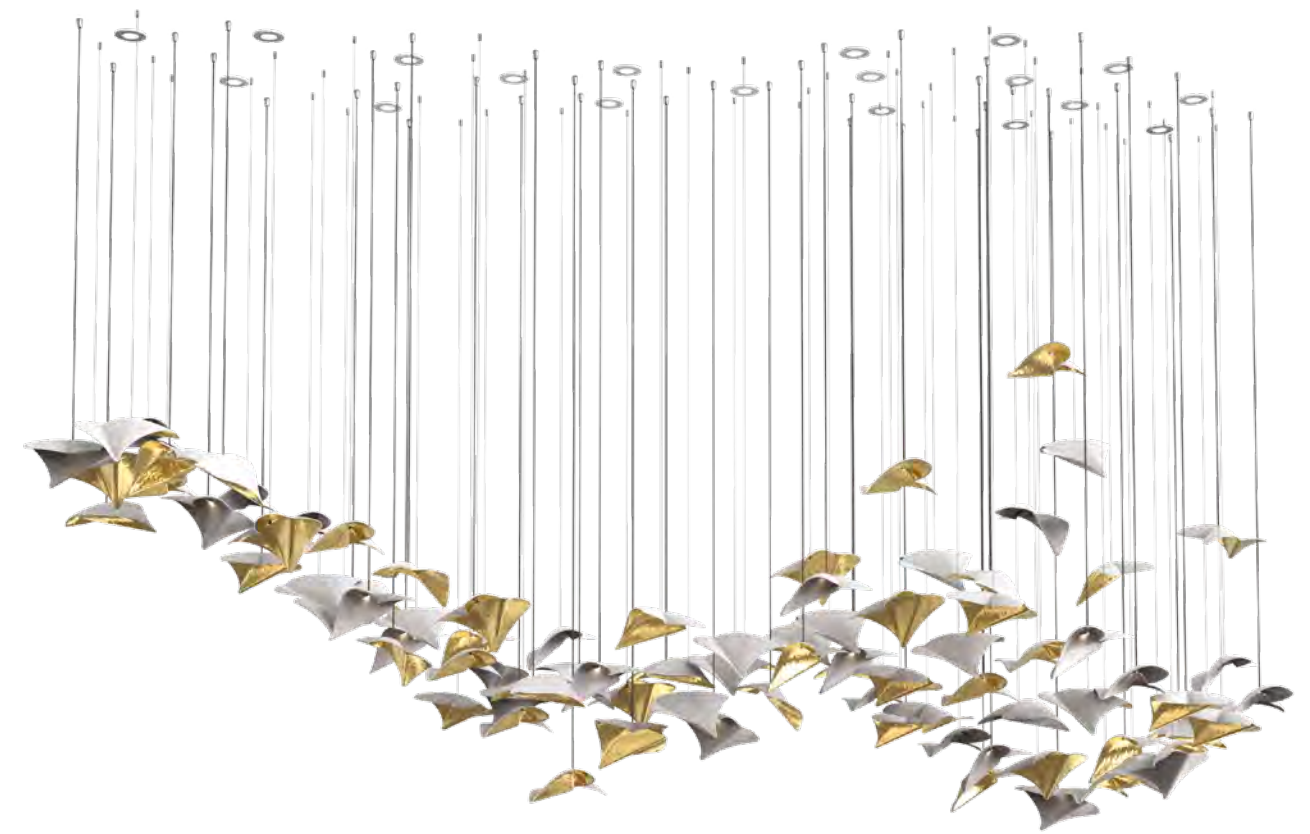

Ori

T766



W 339 cm - D 139 cm - h¹ 137 cm . W 133" - D 55" - h¹ 54"
19 Spotled 9W - 3000K - 41 Microled 0,28W - 3000K



Ori

T766/A



W 420 cm - D 208 cm - h¹ 101 cm . W 165" - D 90" - h¹ 40"
12 Spotled 9W - 3000K - 35 Microled 0,28W - 3000K

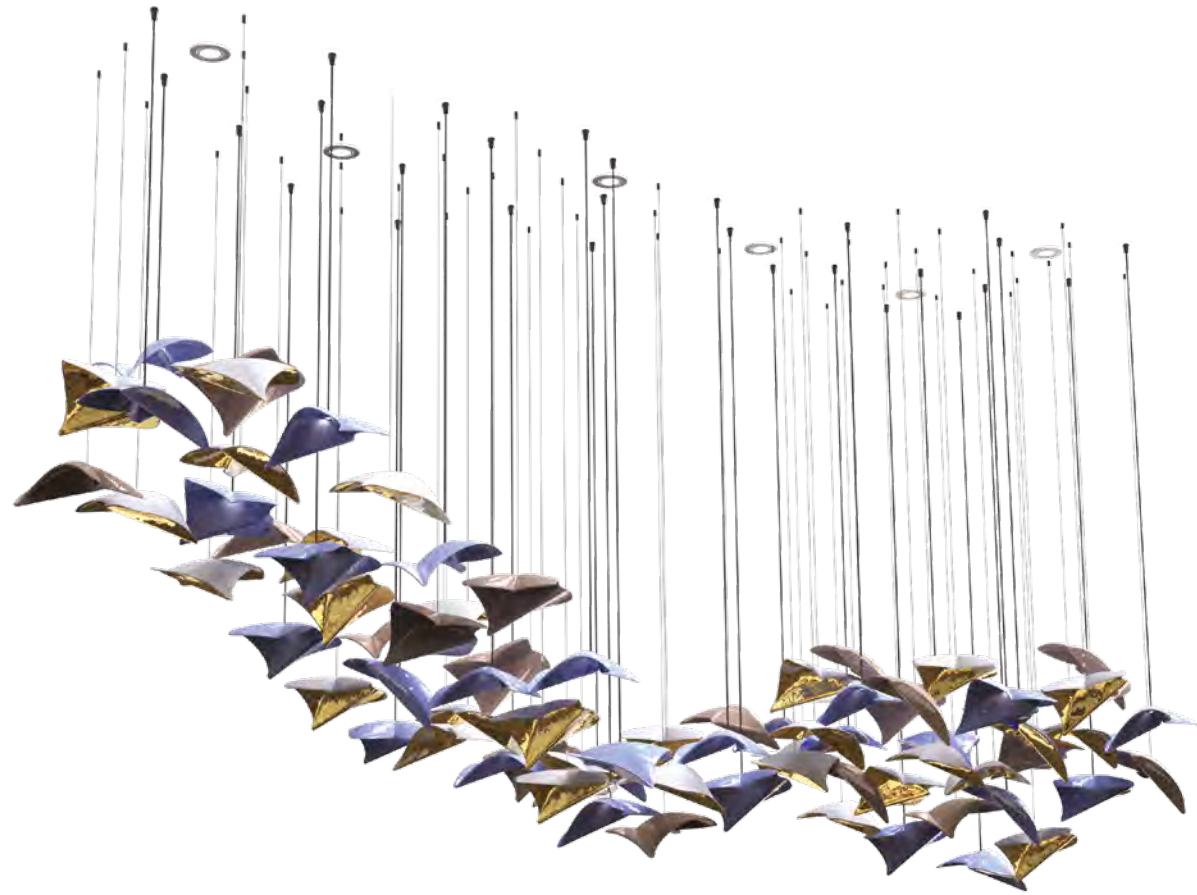

Ori

T766/B



W 300 cm - D 111 cm - h¹ 106 cm . W 118" - D 44" - h¹ 42"
6 Spotled 9W - 3000K - 28 Microled 0,28W - 3000K





Ori

T766/C1



W 557 cm - D 806 cm - h¹ 348 cm
W 219" - D 317" - h¹ 137"
56 Spotled 9W - 3000K
105 Microled 0,28W - 3000K



Ori

T766/C



W 557 cm - D 510 cm - h¹ 260 cm . W 219" - D 200" - h¹ 102"
42 Spotled 9W - 3000K - 90 Microled 0,28W - 3000K

Kaleido Suggestions

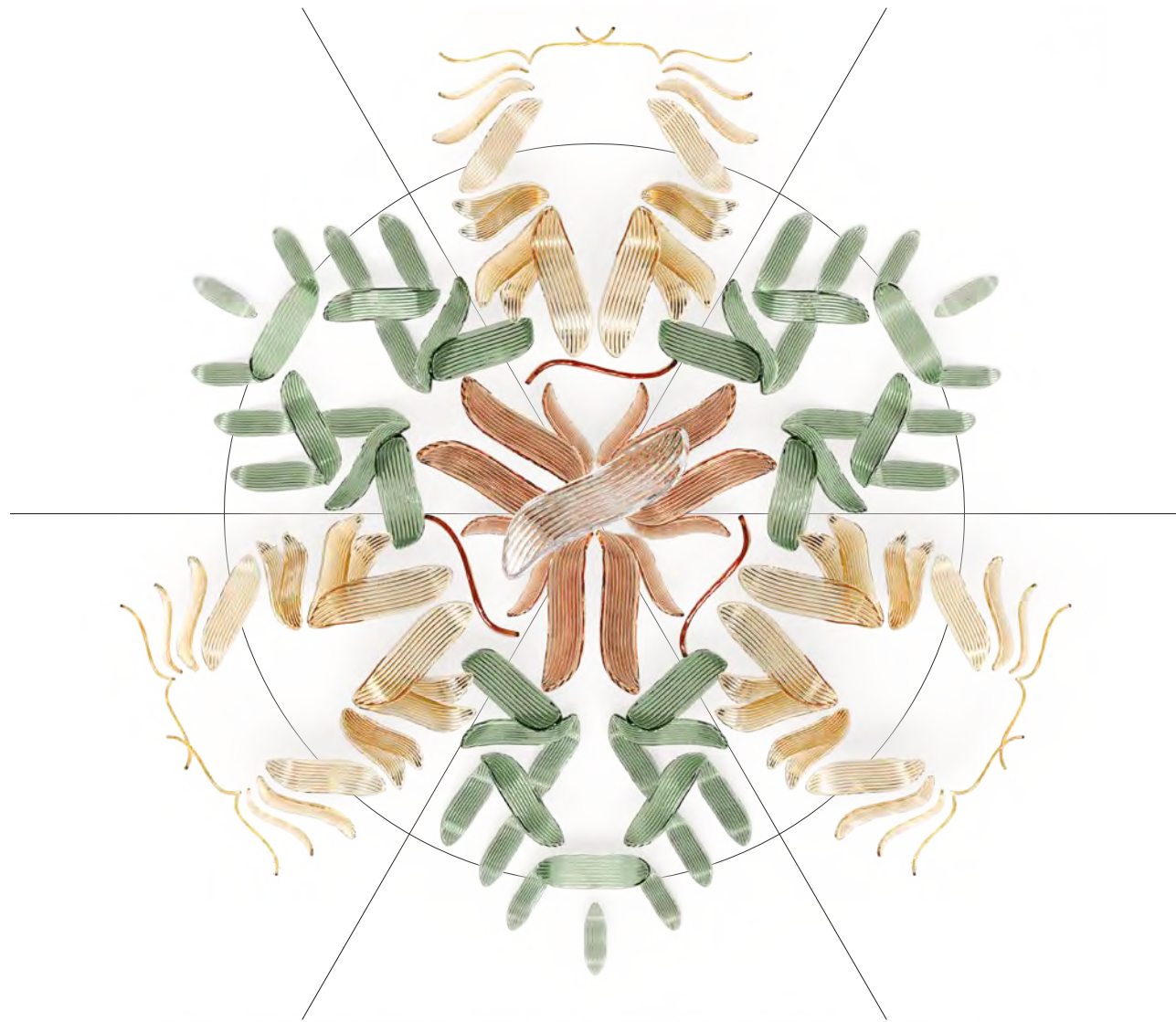

Pluma

Specification Pluma

Design Italamp Studio



Available finishes Finiture disponibili

- | | |
|------------|----------------|
| 1. Clear | 1. Trasparente |
| 2. Etched | 2. Acidato |
| 3. Smoked | 3. Fumè |
| 4. Teak | 4. Teak |
| 5. Dove | 5. Tortora |
| 6. Amber | 6. Ambra |
| 7. Topaz | 7. Topazio |
| 8. Bluino | 8. Bluino |
| 9. Sage | 9. Salvia |
| 10. Salmon | 10. Salmone |

The compositions are suggestions to stimulate the imagination and creativity of the viewer, a concrete tool in the service of design. Please be advised that the color of the glass varies slightly from what is shown in the pictures. All products in the ITALAMP collections are carefully created using craft techniques, all glass components are handmade and for this reason the single element shape might vary slightly. These variations are not imperfections but characteristic peculiarities of the production process.

Le composizioni sono suggestioni per stimolare la fantasia e la creatività del cliente, uno strumento concreto al servizio del design. Si prega di notare che il colore del vetro varia leggermente da quello mostrato nelle immagini. Tutti i prodotti delle collezioni ITALAMP sono realizzati con cura utilizzando tecniche artigianali, tutti i componenti in vetro sono realizzati a mano e per questo motivo la forma del singolo elemento potrebbe variare leggermente. Queste variazioni non sono imperfezioni ma caratteristiche peculiarità del processo produttivo.

Spotted - Recessed



3W 3000K CRI>90 240lm
Beam 36°

9W 3000K CRI>80 1200lm
Beam 40°

Spotted - Trimless



3W 3000K CRI>90 240lm
Beam 36°

12W 3000K CRI>90 1100lm
Beam 40°

60 mm - 2,4" inch



60 mm - 2,4" inch



weight 0,2 Kg - 0,4 lbs

170 mm - 6,7" inch

1.



2.



3.



4.



5.



6.



7.



8.



9.



10.



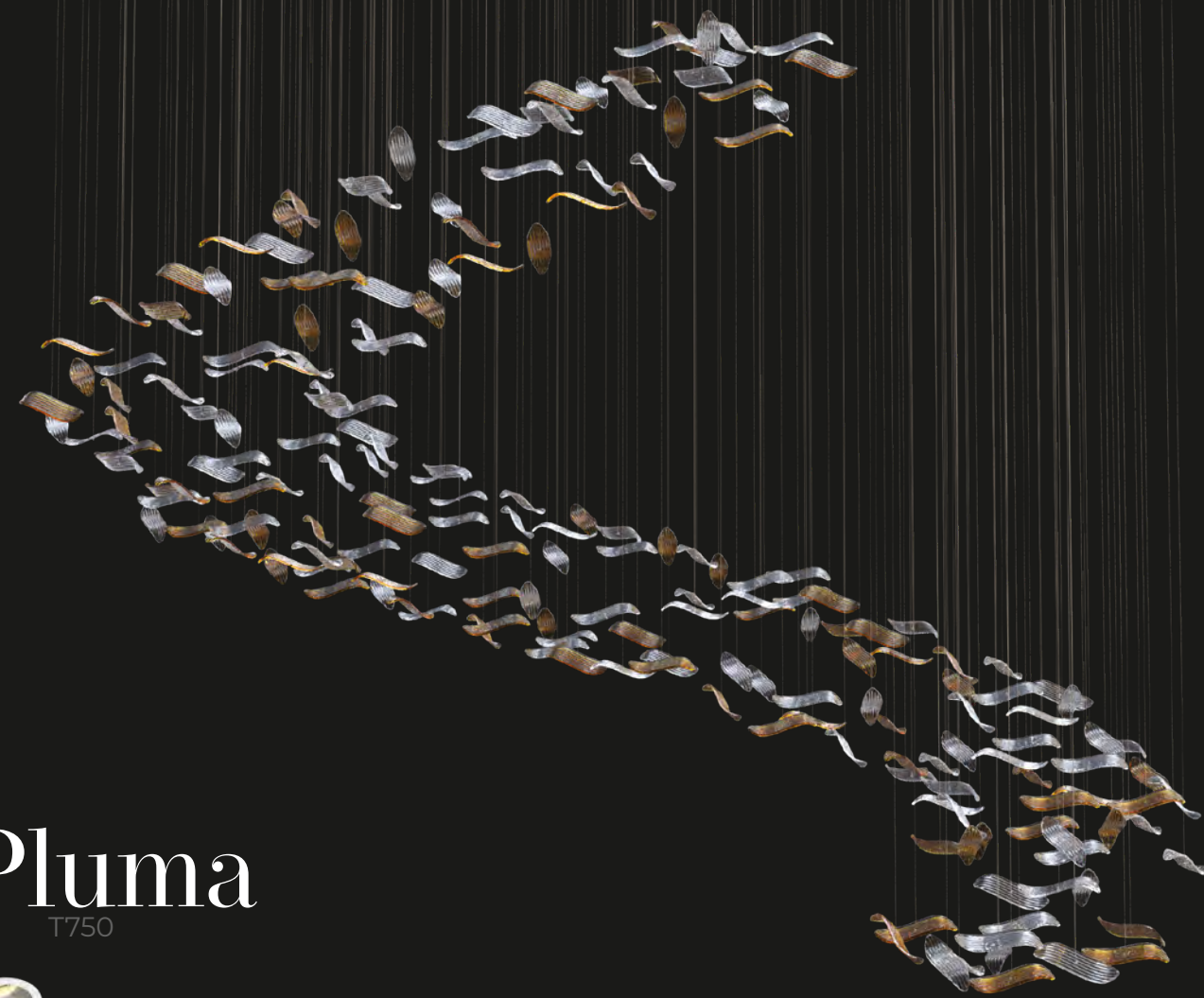

Pluma

T750



W 294 cm - D 294 cm - h¹ 239 cm . W 116" - D 116" - h¹ 94"
18 Spotled 9W - 3000K





Pluma

T750/A



Ø 160 cm - h¹ 72 cm
Ø 62" - h¹ 28"
9 Spotled 9W - 3000K



Neda

Specification

Neda

Design Italamp Studio



Available finishes

Finiture disponibili

- | | |
|------------|----------------|
| 1. Clear | 1. Trasparente |
| 2. Etched | 2. Acidato |
| 3. Smoked | 3. Fumè |
| 4. Teak | 4. Teak |
| 5. Dove | 5. Tortora |
| 6. Amber | 6. Ambra |
| 7. Topaz | 7. Topazio |
| 8. Bluino | 8. Bluino |
| 9. Sage | 9. Salvia |
| 10. Salmon | 10. Salmone |

The compositions are suggestions to stimulate the imagination and creativity of the viewer, a concrete tool in the service of design. Please be advised that the color of the glass varies slightly from what is shown in the pictures. All products in the ITALAMP collections are carefully created using craft techniques, all glass components are handmade and for this reason the single element shape might vary slightly. These variations are not imperfections but characteristic peculiarities of the production process.

Le composizioni sono suggestioni per stimolare la fantasia e la creatività del cliente, uno strumento concreto al servizio del design. Si prega di notare che il colore del vetro varia leggermente da quello mostrato nelle immagini. Tutti i prodotti delle collezioni ITALAMP sono realizzati con cura utilizzando tecniche artigianali, tutti i componenti in vetro sono realizzati a mano e per questo motivo la forma del singolo elemento potrebbe variare leggermente. Queste variazioni non sono imperfezioni ma caratteristiche peculiarità del processo produttivo.

Spotted - Recessed



3W 3000K CRI>90 240lm Beam 36° 9W 3000K CRI>80 1200lm Beam 40°

Spotted - Trimless



3W 3000K CRI>90 240lm Beam 36° 12W 3000K CRI>90 1100lm Beam 40°

60 mm - 2,4" inch

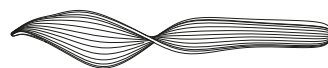

60 mm - 2,4" inch

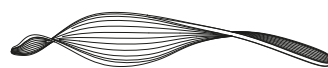

weight 0,35 Kg - 0,8 lbs

360 mm - 14" inch

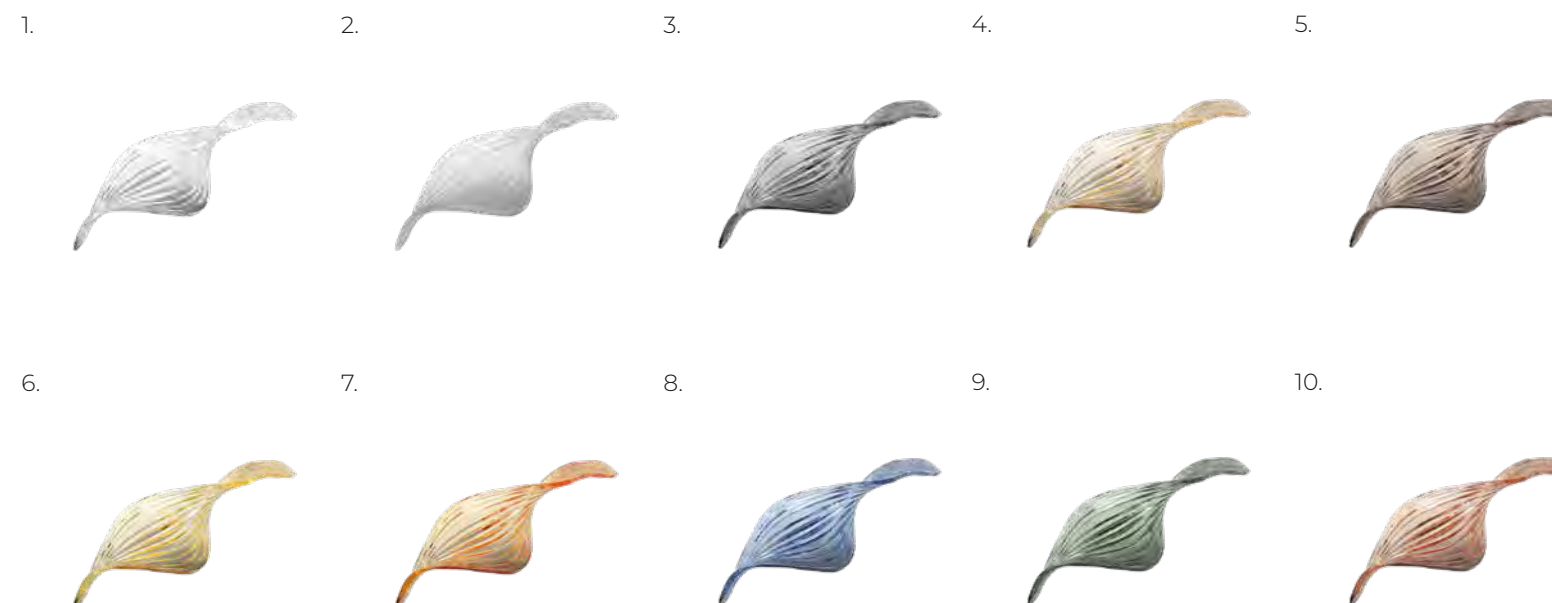



Neda

T764



Neda

T764



W 1132 cm - D 533 cm - h¹ 138 cm . W 446" - D 210" - h¹ 54"
35 Spotled 9W - 3000K





as03



Neda

T764



W 1132 cm - D 533 cm - h¹ 138 cm . W 446" - D 210" - h¹ 54"
35 Spotled 9W - 3000K



Sella

Specification

Sella

Design Italamp Studio



Available with led inside
Disponibile con luce sulla foglia

Available finishes Finiture disponibili

- | | |
|------------|----------------|
| 1. Clear | 1. Trasparente |
| 2. Etched | 2. Acidato |
| 3. Smoked | 3. Fumè |
| 4. Teak | 4. Teak |
| 5. Dove | 5. Tortora |
| 6. Amber | 6. Ambra |
| 7. Topaz | 7. Topazio |
| 8. Bluino | 8. Bluino |
| 9. Sage | 9. Salvia |
| 10. Salmon | 10. Salmone |

The compositions are suggestions to stimulate the imagination and creativity of the viewer, a concrete tool in the service of design. Please be advised that the color of the glass varies slightly from what is shown in the pictures. All products in the ITALAMP collections are carefully created using craft techniques, all glass components are handmade and for this reason the single element shape might vary slightly. These variations are not imperfections but characteristic peculiarities of the production process.

Le composizioni sono suggestioni per stimolare la fantasia e la creatività del cliente, uno strumento concreto al servizio del design. Si prega di notare che il colore del vetro varia leggermente da quello mostrato nelle immagini. Tutti i prodotti delle collezioni ITALAMP sono realizzati con cura utilizzando tecniche artigianali, tutti i componenti in vetro sono realizzati a mano e per questo motivo la forma del singolo elemento potrebbe variare leggermente. Queste variazioni non sono imperfezioni ma caratteristiche peculiarità del processo produttivo.

100 mm - 3,9" inch

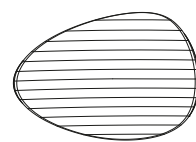

70 mm - 2,7" inch



weight 0,3 Kg - 0,7 lbs

150 mm - 5,9" inch

Spotted - Recessed



3W 3000K CRI>90 240lm
Beam 36°



9W 3000K CRI>80 1200lm
Beam 40°

Spotted - Trimless



3W 3000K CRI>90 240lm
Beam 36°



12W 3000K CRI>90 1100lm
Beam 40°

Microled - On leaf



0,28W 3000K CRI>80 35lm
Beam 120°

1.



2.



3.



4.



5.



6.



7.



8.



9.



10.





Sella

T770



W 520 cm - D 365 cm - h¹ 80 cm . W 205" - D 144" - h¹ 32"
23 Spotled 9W - 3000K - 100 Microled 0,28W - 3000K



Sella

T770/A



W 345 cm - D 445 cm - h¹ 50 cm
W 136" - D 175" - h¹ 12"
48 Spotted 9W - 3000K

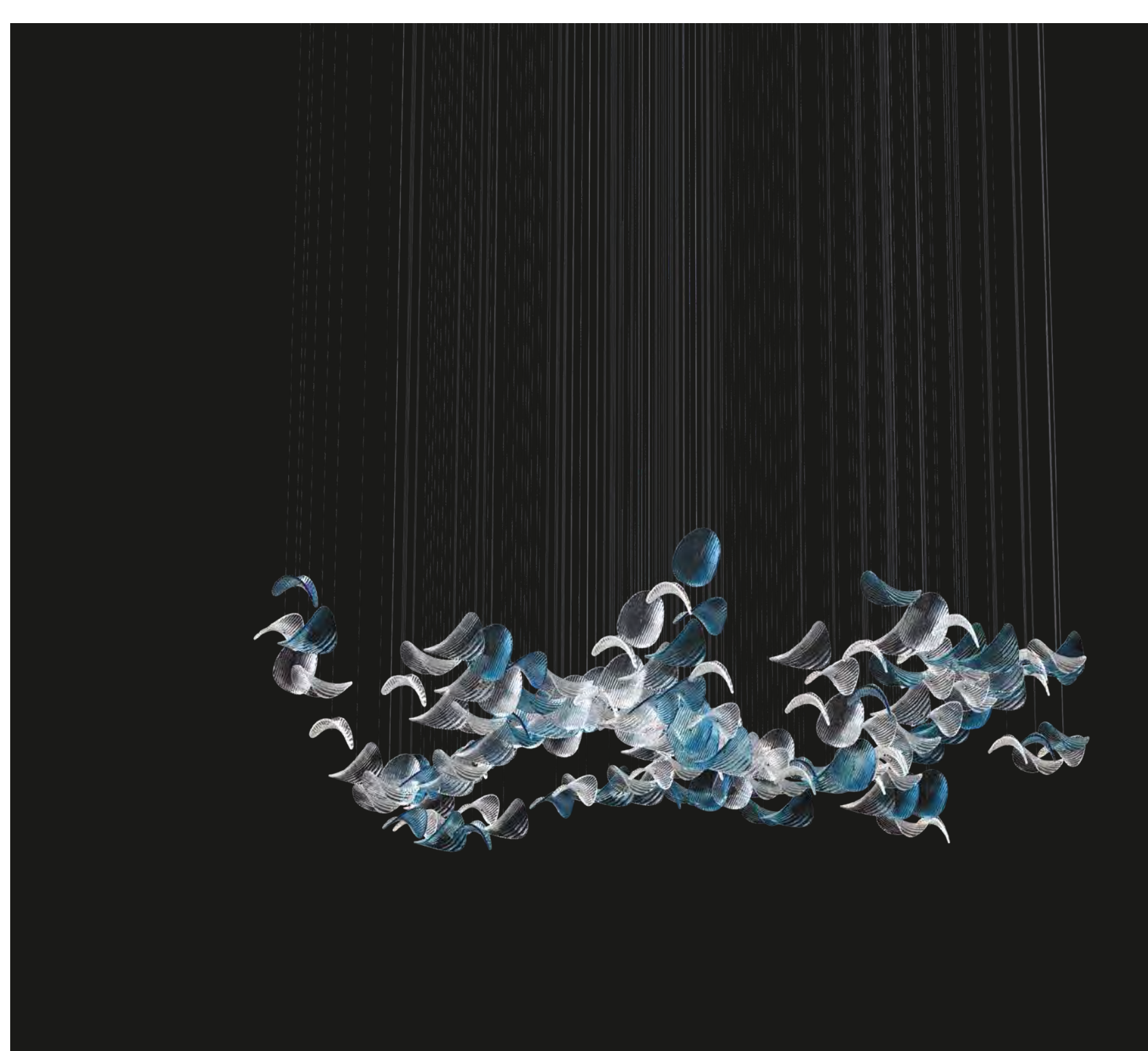

Sella

T770/B



W 200 cm - D 200 cm - h¹ 50 cm . W 50" - D 50" - h¹ 12"
24 Spotted 9W - 3000K



Kaleido Suggestions



Flora

Specification Flora

Design S. Traverso - R. Nardi



Available finishes Finiture disponibili

- | | |
|------------------------|----------------------|
| 1. Clear | 1. Trasparente |
| 2. Clear + Gold powder | 2. Trasparente + Oro |

The compositions are suggestions to stimulate the imagination and creativity of the viewer, a concrete tool in the service of design. Please be advised that the color of the glass varies slightly from what is shown in the pictures. All products in the ITALAMP collections are carefully created using craft techniques, all glass components are handmade and for this reason the single element shape might vary slightly. These variations are not imperfections but characteristic peculiarities of the production process.

Le composizioni sono suggestioni per stimolare la fantasia e la creatività del cliente, uno strumento concreto al servizio del design. Si prega di notare che il colore del vetro varia leggermente da quello mostrato nelle immagini. Tutti i prodotti delle collezioni ITALAMP sono realizzati con cura utilizzando tecniche artigianali, tutti i componenti in vetro sono realizzati a mano e per questo motivo la forma del singolo elemento potrebbe variare leggermente. Queste variazioni non sono imperfezioni ma caratteristiche peculiarità del processo produttivo.

Spotted - Recessed



3W 3000K CRI>90 240lm Beam 36° 9W 3000K CRI>80 1200lm Beam 40°

Spotted - Trimless



3W 3000K CRI>90 240lm Beam 36° 12W 3000K CRI>90 1100lm Beam 40°

100 mm - 3,9" inch



90 mm - 3,5" inch



weight 0,95 Kg - 2 lbs

450 mm - 18" inch

1.



2.





Flora

T760



W 236 cm - D 236 cm - h¹ 260 cm . W 93" - D 93" - h¹ 102"
9 Spotted 9W - 3000K





Flora

T760/A



W 718 cm - D 685 cm - h¹ 174 cm
W 283" - D 270" - h¹ 68"
48 Spotted 9W - 3000K



Flora

T760/B



W 252 cm - D 252 cm - h¹ 95 cm . W 99" - D 99" - h¹ 37"
8 Spotled 9W - 3000K



Flora

T760/C



W 644 cm - D 434 cm - h¹ 556 cm . W 254" - D 171" - h¹ 219"
29 Spotted 9W - 3000K



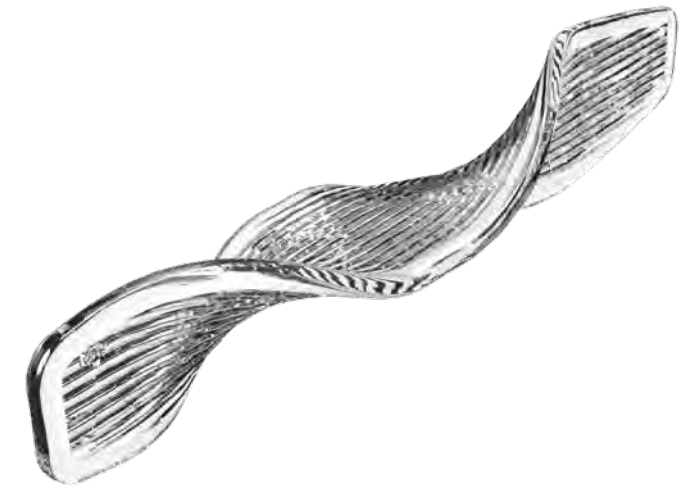
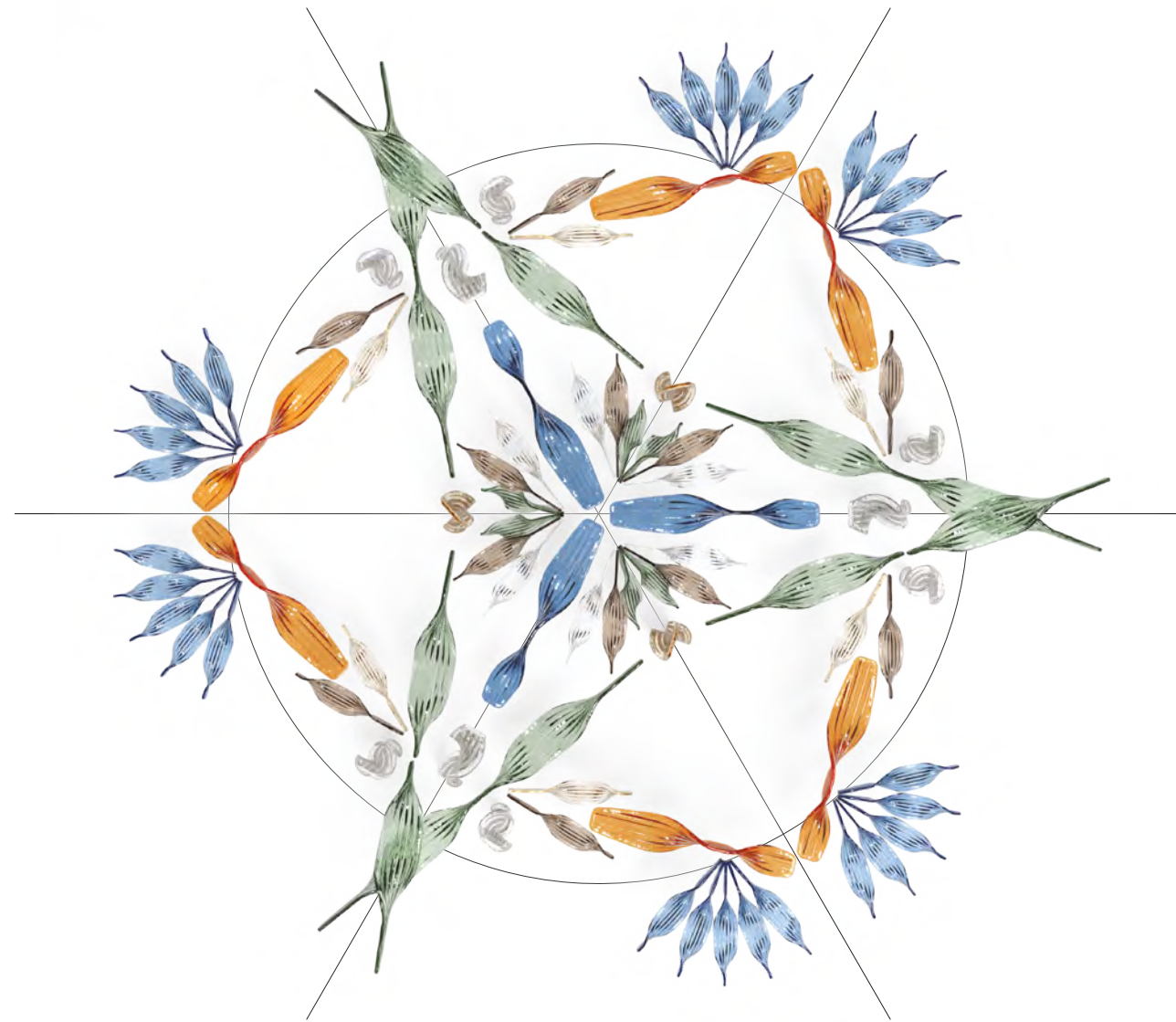

Alyssa

Specification

Alyssa

Design S. Traverso - R. Nardi



Available finishes Finiture disponibili

- | | |
|------------|----------------|
| 1. Clear | 1. Trasparente |
| 2. Etched | 2. Acidato |
| 3. Smoked | 3. Fumè |
| 4. Teak | 4. Teak |
| 5. Dove | 5. Tortora |
| 6. Amber | 6. Ambra |
| 7. Topaz | 7. Topazio |
| 8. Bluino | 8. Bluino |
| 9. Sage | 9. Salvia |
| 10. Salmon | 10. Salmone |

The compositions are suggestions to stimulate the imagination and creativity of the viewer, a concrete tool in the service of design. Please be advised that the color of the glass varies slightly from what is shown in the pictures. All products in the ITALAMP collections are carefully created using craft techniques, all glass components are handmade and for this reason the single element shape might vary slightly. These variations are not imperfections but characteristic peculiarities of the production process.

Le composizioni sono suggestioni per stimolare la fantasia e la creatività del cliente, uno strumento concreto al servizio del design. Si prega di notare che il colore del vetro varia leggermente da quello mostrato nelle immagini. Tutti i prodotti delle collezioni ITALAMP sono realizzati con cura utilizzando tecniche artigianali, tutti i componenti in vetro sono realizzati a mano e per questo motivo la forma del singolo elemento potrebbe variare leggermente. Queste variazioni non sono imperfezioni ma caratteristiche peculiarità del processo produttivo.

Spotted - Recessed



3W 3000K CRI>90 240lm Beam 36° 9W 3000K CRI>80 1200lm Beam 40°

Spotted - Trimless



3W 3000K CRI>90 240lm Beam 36° 12W 3000K CRI>90 1100lm Beam 40°

60 mm - 2,4" inch



55 mm - 2,1" inch



weight 0,3 Kg - 0,7 lbs

300 mm - 11,8" inch



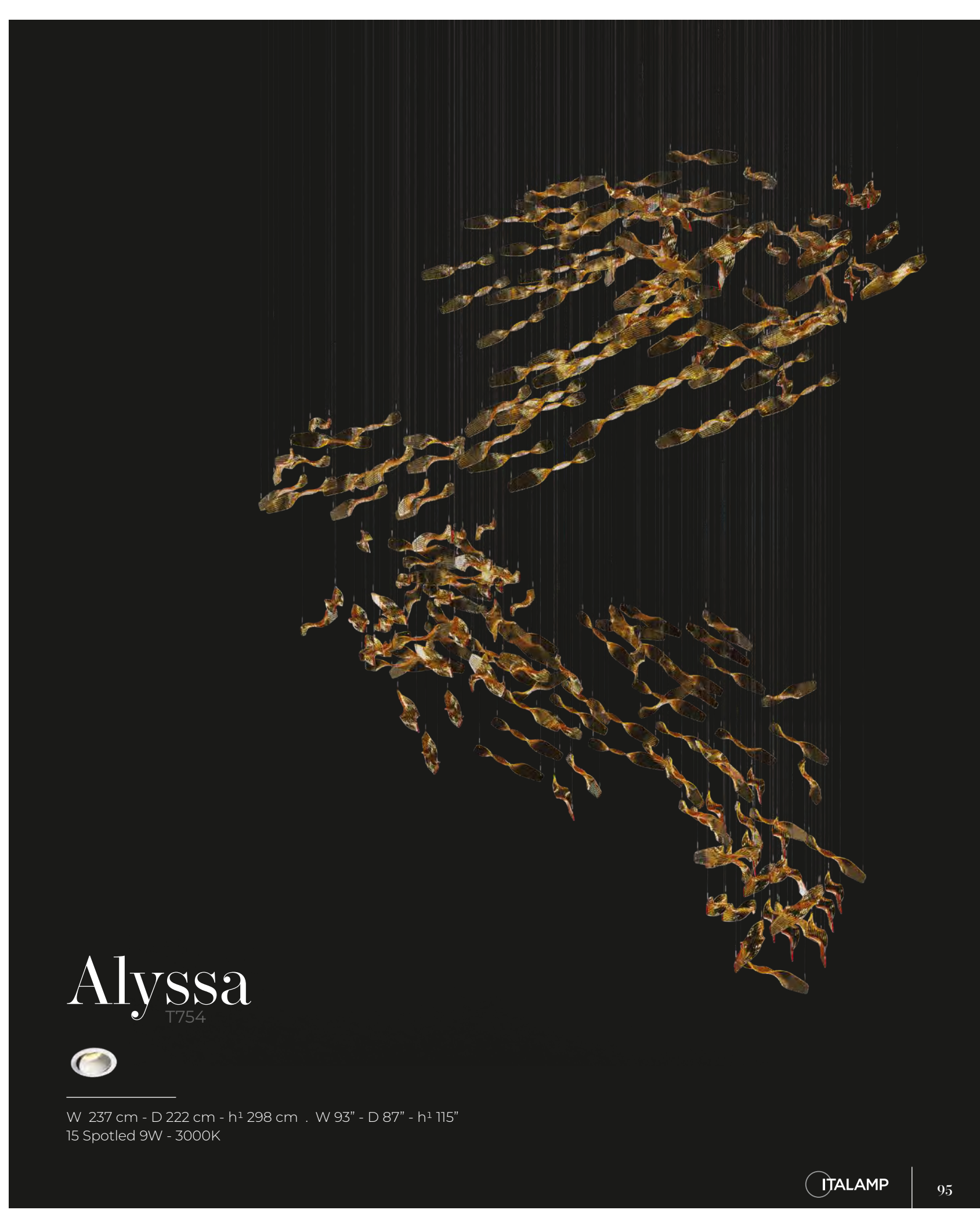

Alyssa

T754



W 237 cm - D 222 cm - h¹ 298 cm . W 93" - D 87" - h¹ 115"
15 Spotled 9W - 3000K

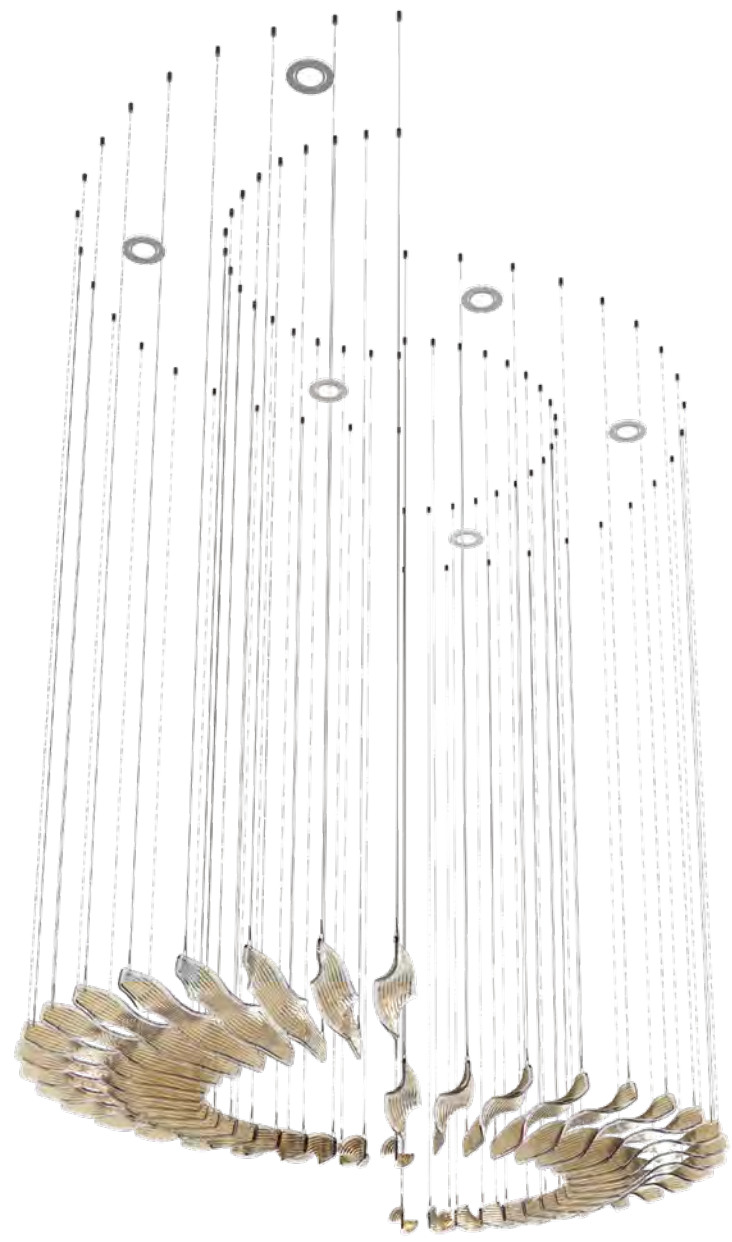

Alyssa

T754/A



W 121 cm - D 179 cm - h¹ 20 cm . W 48" - D 70" - h¹ 8"
6 Spotted 9W - 3000K

Alyssa

T754/B



W 385 cm - D 618 cm - h¹ 20 cm . W 151" - D 243" - h¹ 8"
27 Spotted 9W - 3000K





Kaleido Suggestions



Marina

Specification Marina

Design S. Traverso - R. Nardi



Available finishes Finiture disponibili

- | | |
|------------|----------------|
| 1. Clear | 1. Trasparente |
| 2. Etched | 2. Acidato |
| 3. Smoked | 3. Fumè |
| 4. Teak | 4. Teak |
| 5. Dove | 5. Tortora |
| 6. Amber | 6. Ambra |
| 7. Topaz | 7. Topazio |
| 8. Bluino | 8. Bluino |
| 9. Sage | 9. Salvia |
| 10. Salmon | 10. Salmone |

The compositions are suggestions to stimulate the imagination and creativity of the viewer, a concrete tool in the service of design. Please be advised that the color of the glass varies slightly from what is shown in the pictures. All products in the ITALAMP collections are carefully created using craft techniques, all glass components are handmade and for this reason the single element shape might vary slightly. These variations are not imperfections but characteristic peculiarities of the production process.

Le composizioni sono suggestioni per stimolare la fantasia e la creatività del cliente, uno strumento concreto al servizio del design. Si prega di notare che il colore del vetro varia leggermente da quello mostrato nelle immagini. Tutti i prodotti delle collezioni ITALAMP sono realizzati con cura utilizzando tecniche artigianali, tutti i componenti in vetro sono realizzati a mano e per questo motivo la forma del singolo elemento potrebbe variare leggermente. Queste variazioni non sono imperfezioni ma caratteristiche peculiarità del processo produttivo.

Spotted - Recessed



3W 3000K CRI>90 240lm
Beam 36°

9W 3000K CRI>80 1200lm
Beam 40°

Spotted - Trimless



3W 3000K CRI>90 240lm
Beam 36°

12W 3000K CRI>90 1100lm
Beam 40°

180 mm - 7" inch

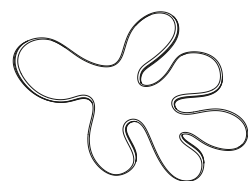

130 mm - 5,1" inch

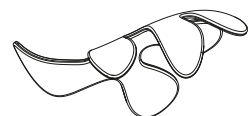

weight 0,75 Kg - 1,7 lbs

300 mm - 11,8" inch

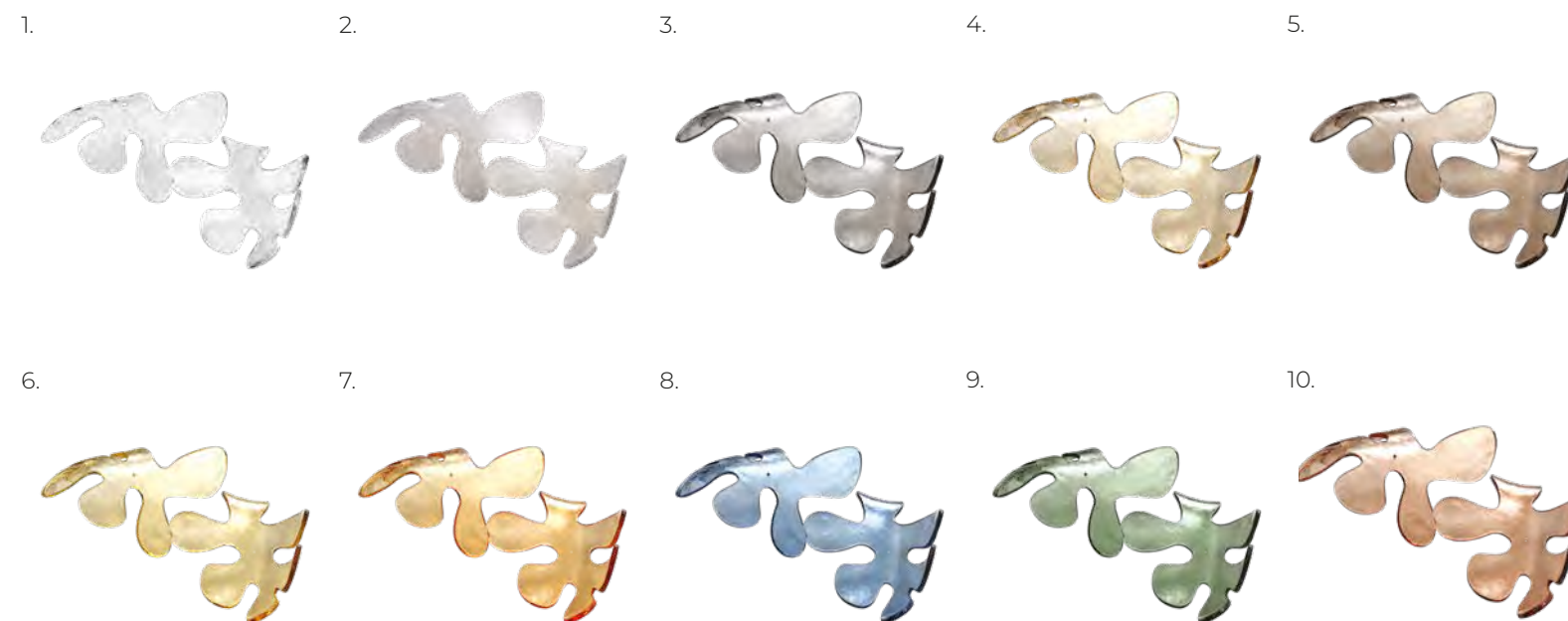



Marina

T762



W 882 cm - D 241 cm - h¹ 242 cm
W 347" - D 95" - h¹ 95"
36 Spotted 9W - 3000K

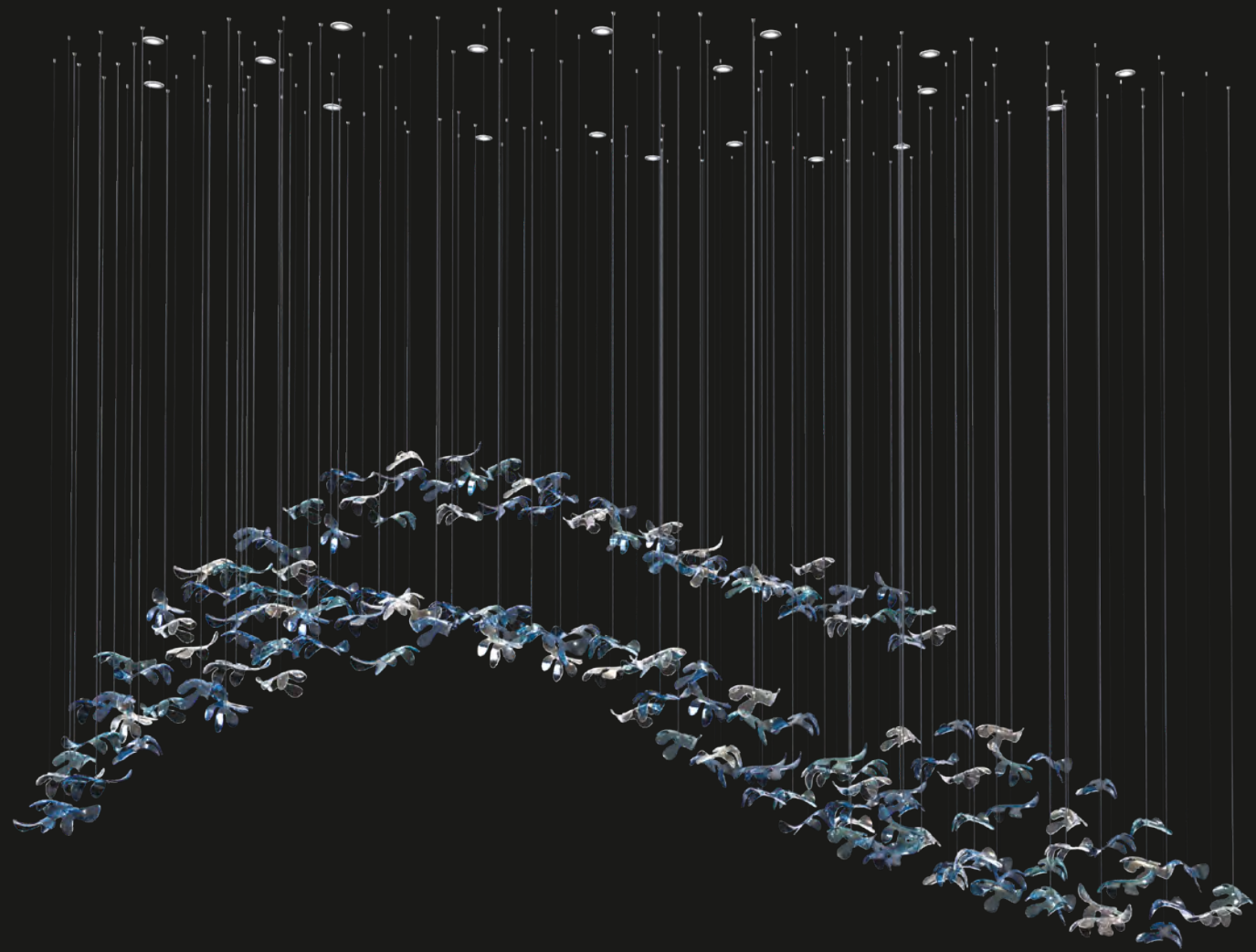

Marina

T762/A



W 501 cm - D 240 cm - h¹ 213 cm . W 197" - D 94" - h¹ 84"
19 Spotled 9W - 3000K

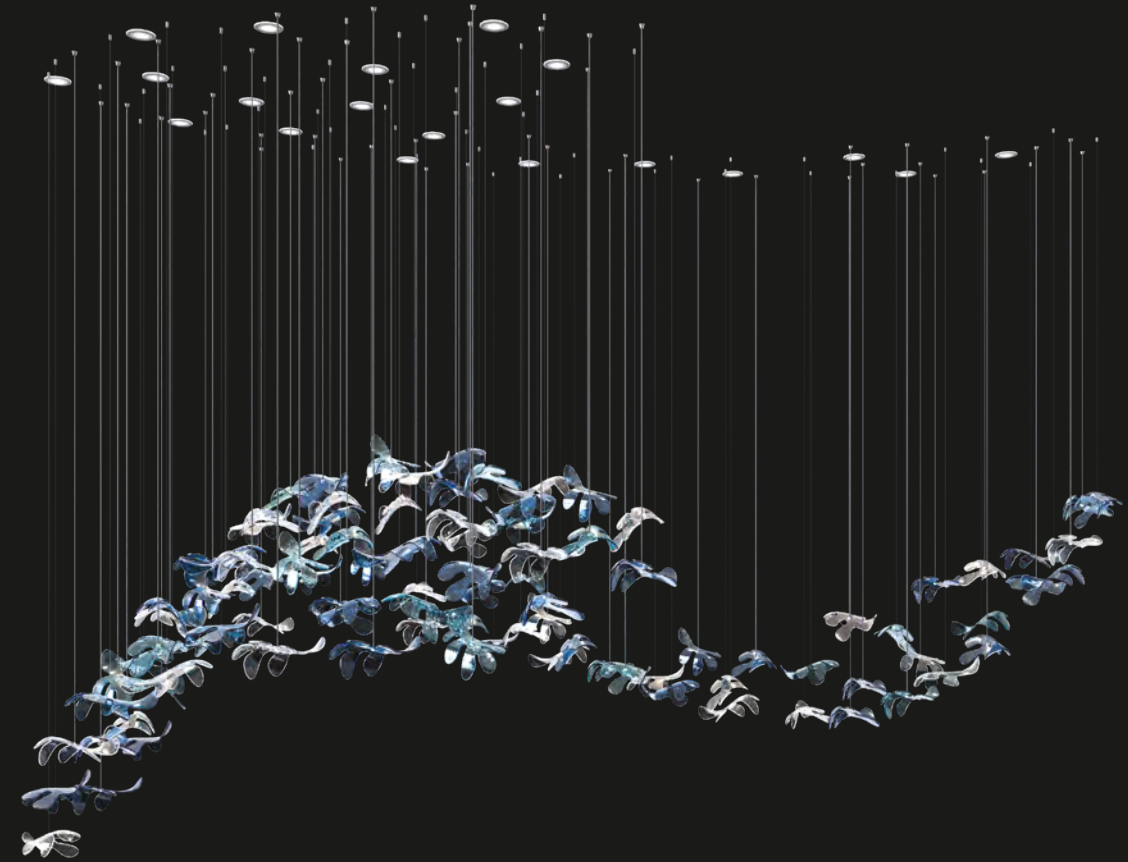

Marina

T762/B



W 365 cm - D 203 cm - h¹ 133 cm . W 54" - D 80" - h¹ 52"
20 Spotled 9W - 3000K

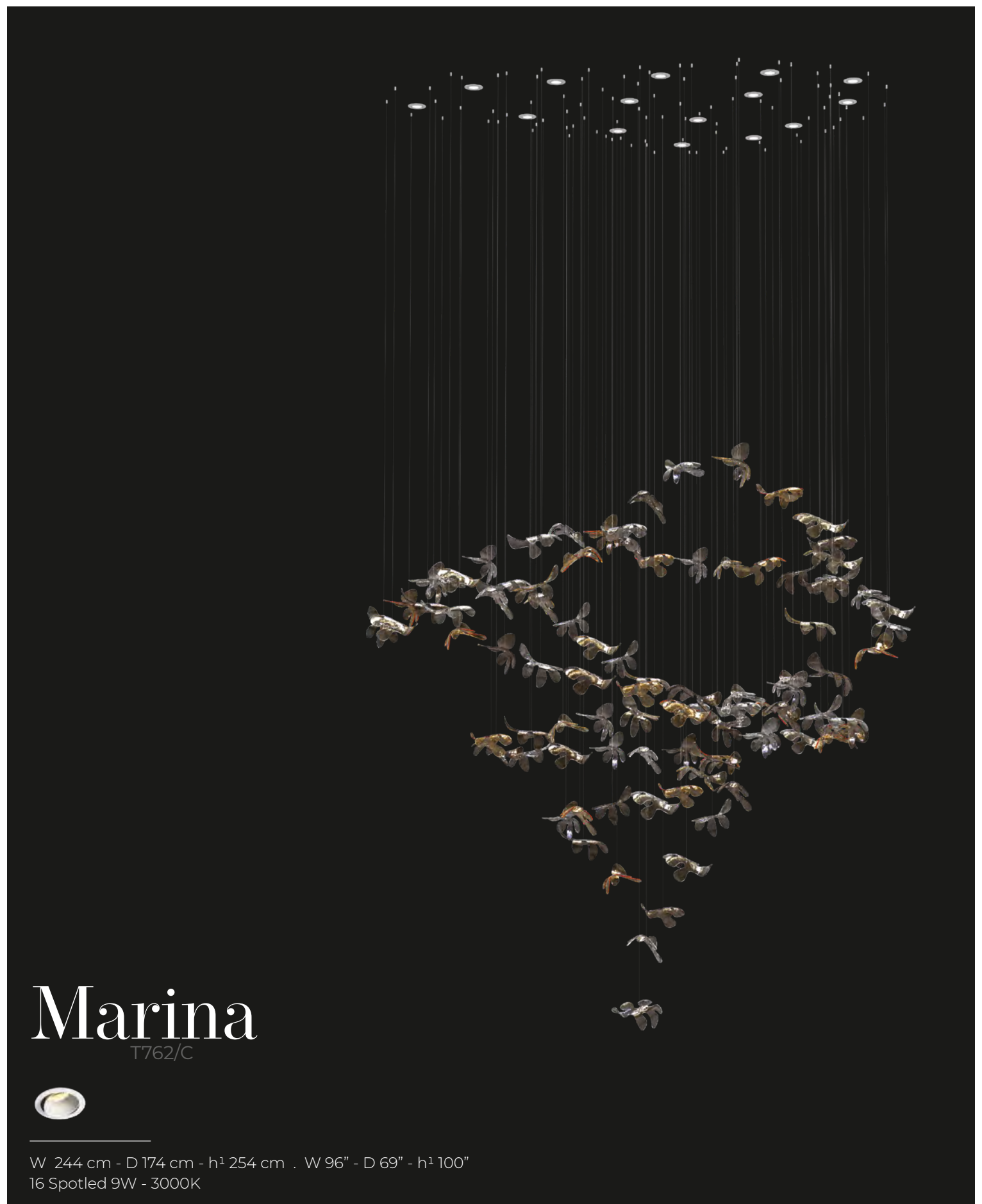

Marina

T762/C



W 244 cm - D 174 cm - h¹ 254 cm . W 96" - D 69" - h¹ 100"
16 Spotled 9W - 3000K

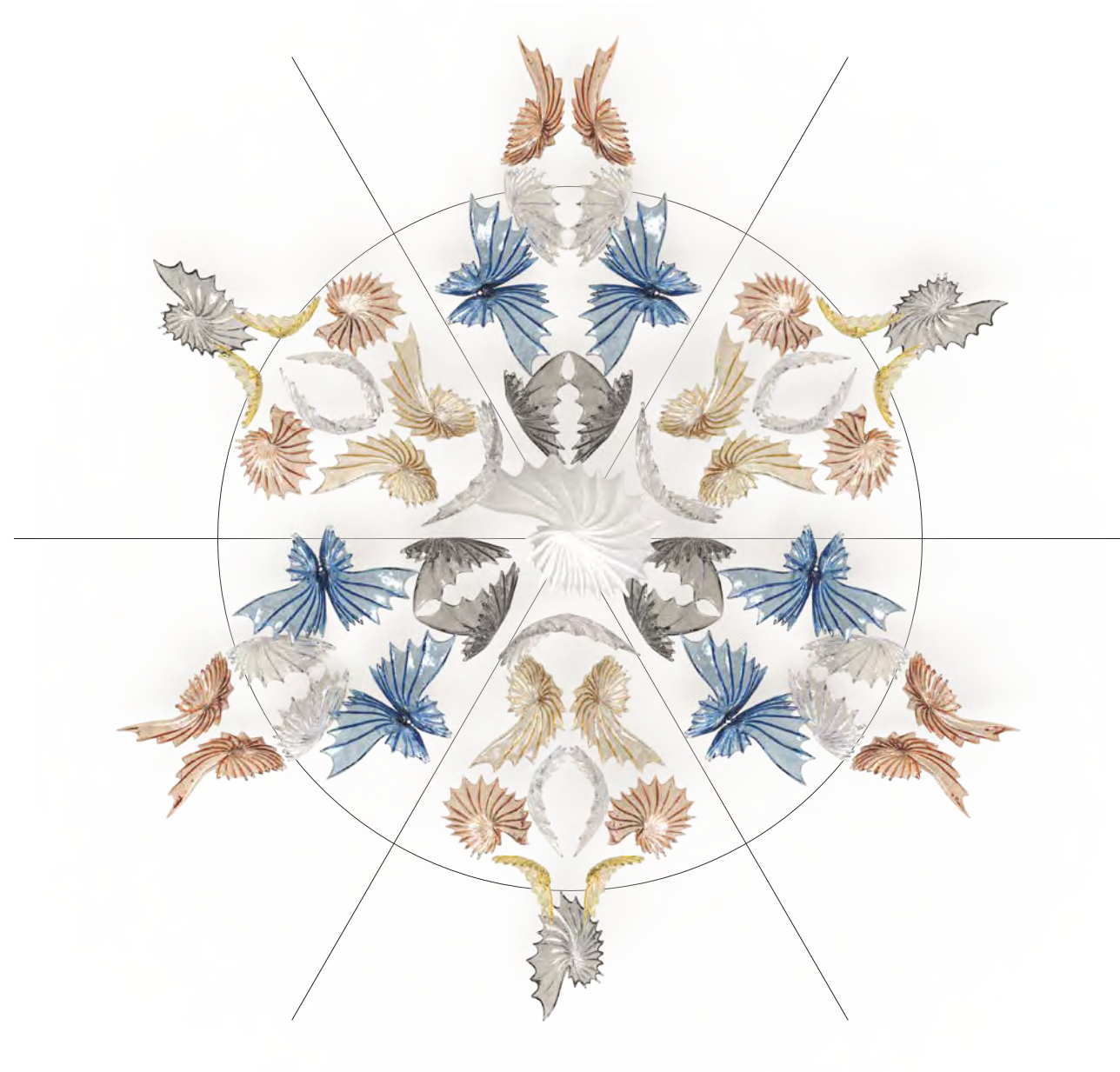

Dalia

Specification Dalia

Design S. Traverso - R. Nardi



Available with led inside
Disponibile con luce sulla foglia

Available finishes Finiture disponibili

- | | |
|------------|----------------|
| 1. Clear | 1. Trasparente |
| 2. Etched | 2. Acidato |
| 3. Smoked | 3. Fumè |
| 4. Teak | 4. Teak |
| 5. Dove | 5. Tortora |
| 6. Amber | 6. Ambra |
| 7. Topaz | 7. Topazio |
| 8. Bluino | 8. Bluino |
| 9. Sage | 9. Salvia |
| 10. Salmon | 10. Salmone |

The compositions are suggestions to stimulate the imagination and creativity of the viewer, a concrete tool in the service of design. Please be advised that the color of the glass varies slightly from what is shown in the pictures. All products in the ITALAMP collections are carefully created using craft techniques, all glass components are handmade and for this reason the single element shape might vary slightly. These variations are not imperfections but characteristic peculiarities of the production process.

Le composizioni sono suggestioni per stimolare la fantasia e la creatività del cliente, uno strumento concreto al servizio del design. Si prega di notare che il colore del vetro varia leggermente da quello mostrato nelle immagini. Tutti i prodotti delle collezioni ITALAMP sono realizzati con cura utilizzando tecniche artigianali, tutti i componenti in vetro sono realizzati a mano e per questo motivo la forma del singolo elemento potrebbe variare leggermente. Queste variazioni non sono imperfezioni ma caratteristiche peculiarità del processo produttivo.

Spotted - Recessed



3W 3000K CRI>90 240lm
Beam 36°

9W 3000K CRI>80 1200lm
Beam 40°

Spotted - Trimless



3W 3000K CRI>90 240lm
Beam 36°

12W 3000K CRI>90 1100lm
Beam 40°

Microled - On leaf



0,28W 3000K CRI>80 35lm
Beam 120°

215 mm - 8,5" inch

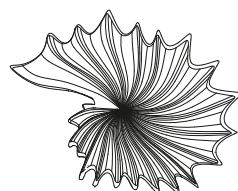

180 mm - 7" inch



weight 0,85 Kg - 1,9 lbs

280 mm - 11" inch

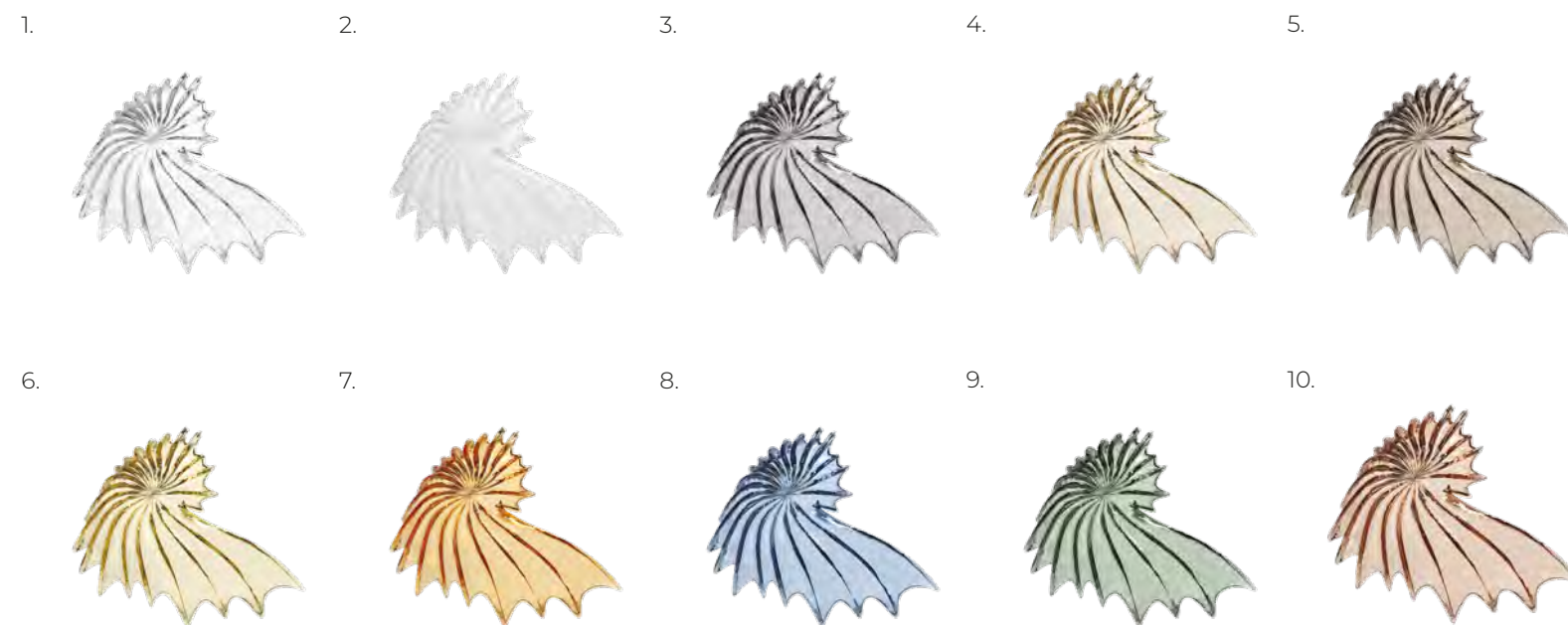



Dalia
T756/A



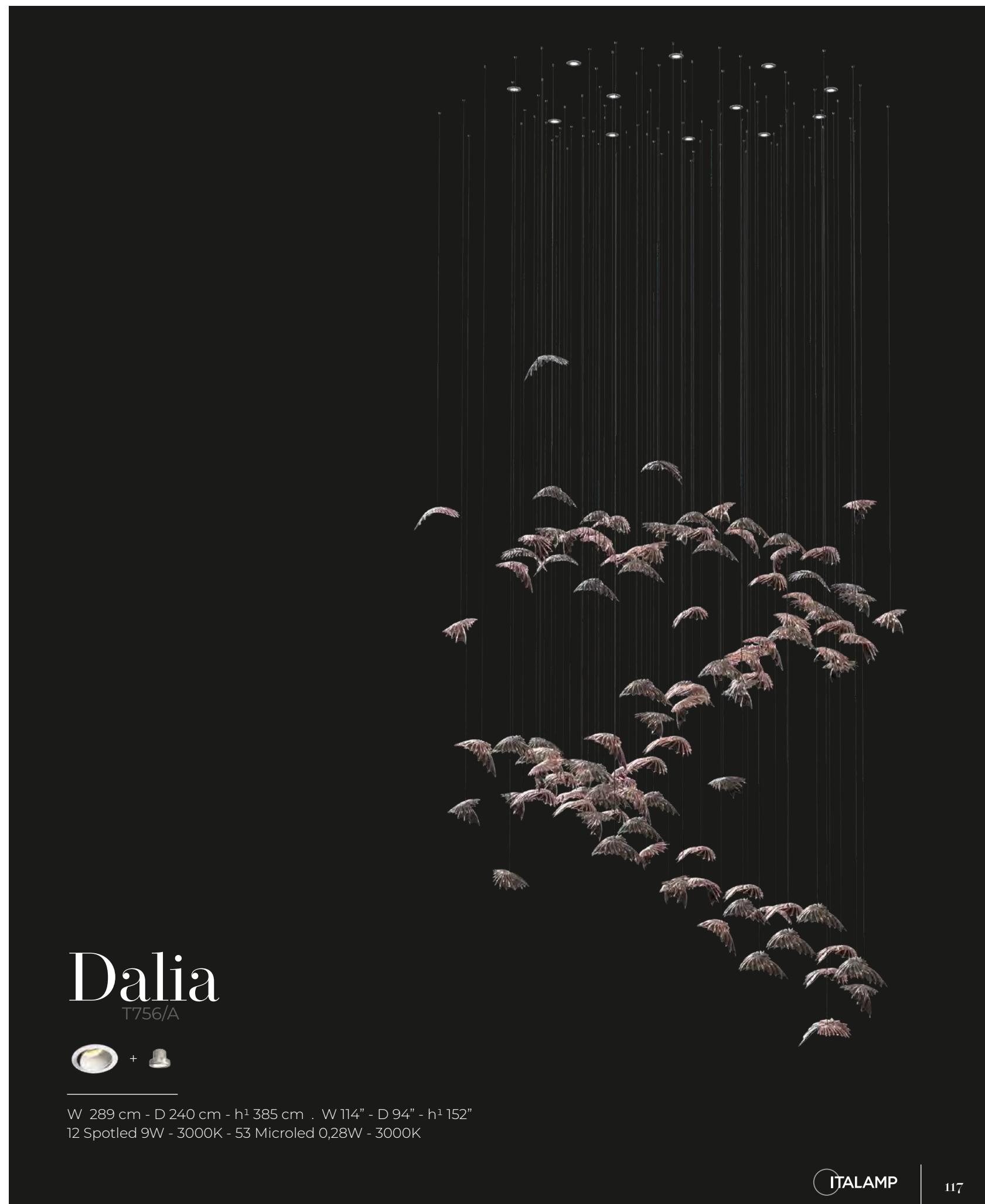

Dalia

T756/A

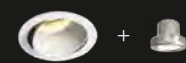

W 289 cm - D 240 cm - h¹ 385 cm . W 114" - D 94" - h¹ 152"
 12 Spotled 9W - 3000K - 53 Microled 0,28W - 3000K



Dalia

T756/C



W 400 cm - D 1000 cm - h¹ 104 cm . W 157" - D 397" - h¹ 41"
34 Spotted 9W - 3000K - 79 Microled - 3000K

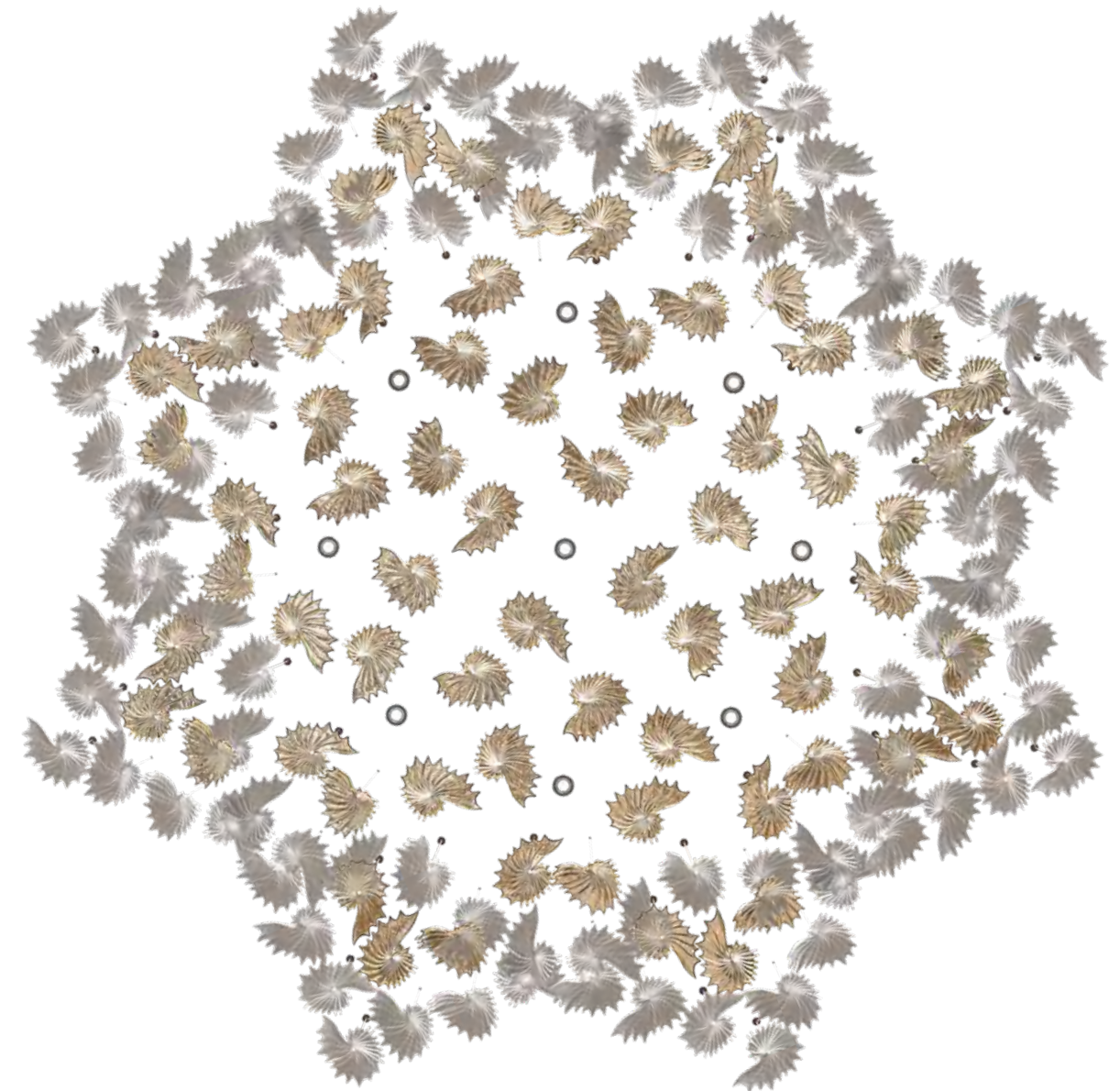

Dalia

T756/D



W 400 cm - D 400 cm - h¹ 104 cm . W 157" - D 157" - h¹ 41"
17 Spotted 9W - 3000K - 79 Microled - 3000K



Dalia

T756



W 433 cm - D 130 cm - h¹ 124 cm . W 170" - D 51" - h¹ 49"
18 Spotted 9W - 3000K



Kaleido Suggestions

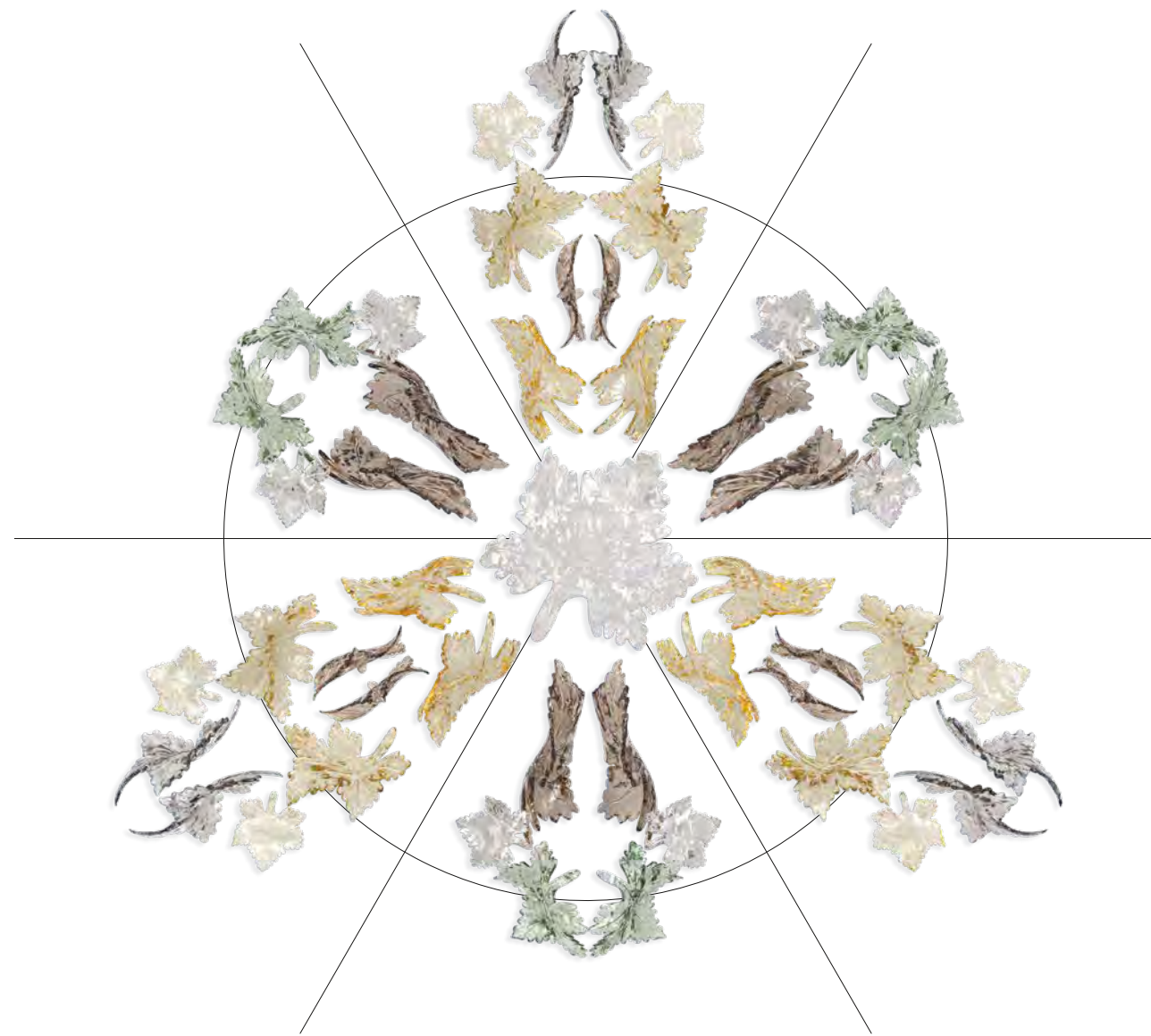

Lisia

Specification

Lisia

Design Italamp Studio



Available finishes

Finiture disponibili

- | | |
|------------|----------------|
| 1. Clear | 1. Trasparente |
| 2. Etched | 2. Acidato |
| 3. Smoked | 3. Fumè |
| 4. Teak | 4. Teak |
| 5. Dove | 5. Tortora |
| 6. Amber | 6. Ambra |
| 7. Topaz | 7. Topazio |
| 8. Bluino | 8. Bluino |
| 9. Sage | 9. Salvia |
| 10. Salmon | 10. Salmone |

The compositions are suggestions to stimulate the imagination and creativity of the viewer, a concrete tool in the service of design. Please be advised that the color of the glass varies slightly from what is shown in the pictures. All products in the ITALAMP collections are carefully created using craft techniques, all glass components are handmade and for this reason the single element shape might vary slightly. These variations are not imperfections but characteristic peculiarities of the production process.

Le composizioni sono suggestioni per stimolare la fantasia e la creatività del cliente, uno strumento concreto al servizio del design. Si prega di notare che il colore del vetro varia leggermente da quello mostrato nelle immagini. Tutti i prodotti delle collezioni ITALAMP sono realizzati con cura utilizzando tecniche artigianali, tutti i componenti in vetro sono realizzati a mano e per questo motivo la forma del singolo elemento potrebbe variare leggermente. Queste variazioni non sono imperfezioni ma caratteristiche peculiarità del processo produttivo.

Spotted - Recessed



3W 3000K CRI>90 240lm
Beam 36°

9W 3000K CRI>80 1200lm
Beam 40°

Spotted - Trimless



3W 3000K CRI>90 240lm
Beam 36°

12W 3000K CRI>90 1100lm
Beam 40°

230 mm - 9" inch



100 mm - 3,9" inch



weight 0,9 Kg - 2 lbs

250 mm - 9,8" inch

1.



2.



3.



4.



5.



6.



7.



8.

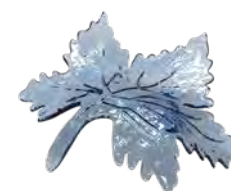

9.



10.





Lisia

T752



W 300 cm - D 300 cm - h¹ 220 cm . W 118" - D 118" - h¹ 87"
24 Spotted 9W - 3000K



Lisia

T752/A



W 200 cm - D 200 cm - h¹ 800 cm . W 79" - D 79" - h¹ 315"
16 Spotted 9W - 3000K



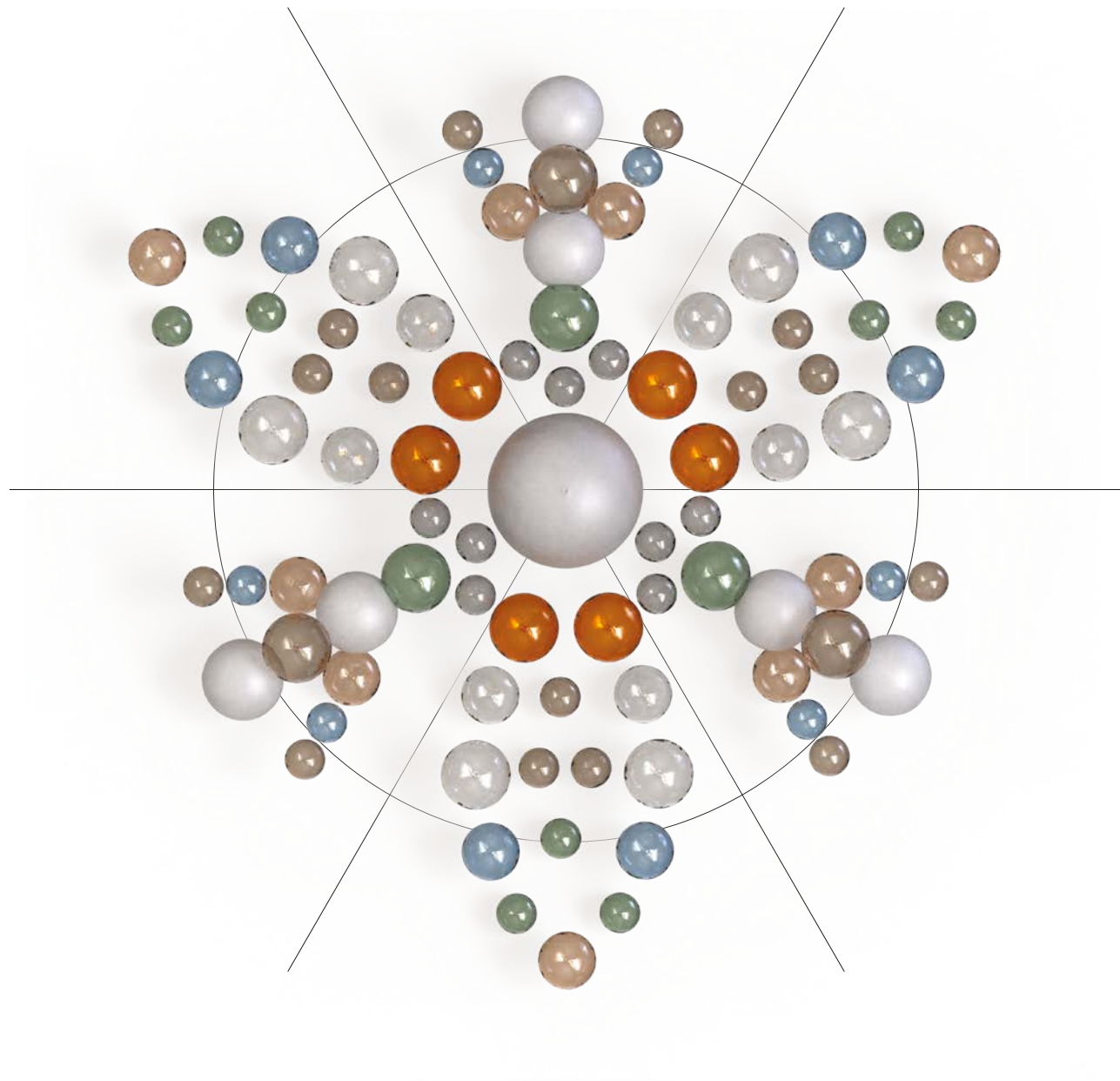

Lila



Available finishes
 Finiture disponibili

- | | |
|------------|----------------|
| 1. Clear | 1. Trasparente |
| 2. Etched | 2. Acidato |
| 3. Smoked | 3. Fumè |
| 4. Teak | 4. Teak |
| 5. Dove | 5. Tortora |
| 6. Amber | 6. Ambra |
| 7. Topaz | 7. Topazio |
| 8. Bluino | 8. Bluino |
| 9. Sage | 9. Salvia |
| 10. Salmon | 10. Salmone |

The compositions are suggestions to stimulate the imagination and creativity of the viewer, a concrete tool in the service of design. Please be advised that the color of the glass varies slightly from what is shown in the pictures. All products in the ITALAMP collections are carefully created using craft techniques, all glass components are handmade and for this reason the single element shape might vary slightly. These variations are not imperfections but characteristic peculiarities of the production process.

Le composizioni sono suggestioni per stimolare la fantasia e la creatività del cliente, uno strumento concreto al servizio del design. Si prega di notare che il colore del vetro varia leggermente da quello mostrato nelle immagini. Tutti i prodotti delle collezioni ITALAMP sono realizzati con cura utilizzando tecniche artigianali, tutti i componenti in vetro sono realizzati a mano e per questo motivo la forma del singolo elemento potrebbe variare leggermente. Queste variazioni non sono imperfezioni ma caratteristiche peculiarità del processo produttivo.

Spotted - Recessed



3W 3000K CRI>90 240lm Beam 36° 9W 3000K CRI>80 1200lm Beam 40°

Spotted - Trimless



3W 3000K CRI>90 240lm Beam 36° 12W 3000K CRI>90 1100lm Beam 40°



Ø70 mm
 Ø7 inch



Ø100 mm
 Ø7 inch

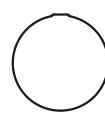

Ø120 mm
 Ø7 inch

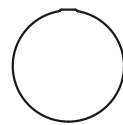

Ø160 mm
 Ø7 inch

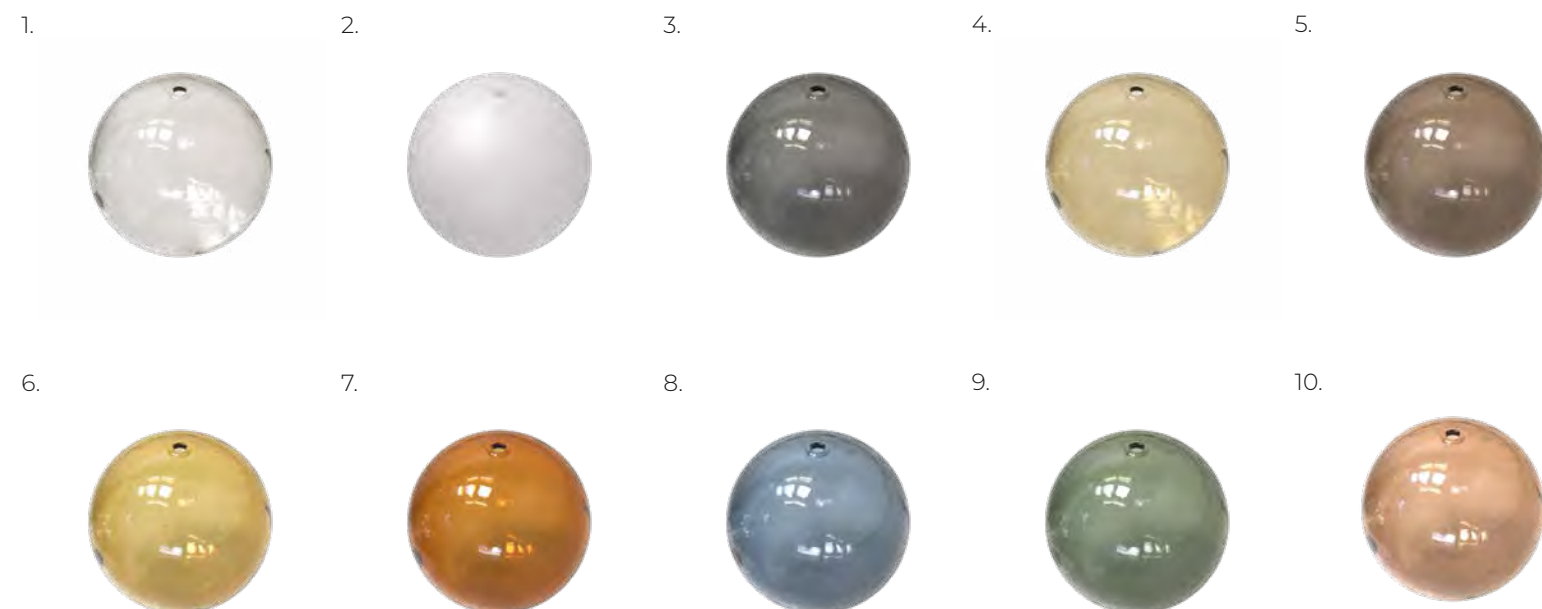



Lila

T776



W 1200 cm - D 5000 cm - h¹ 300 cm . W 472" - D 197" - h¹ 118"
530 Spotted 9W - 3000K



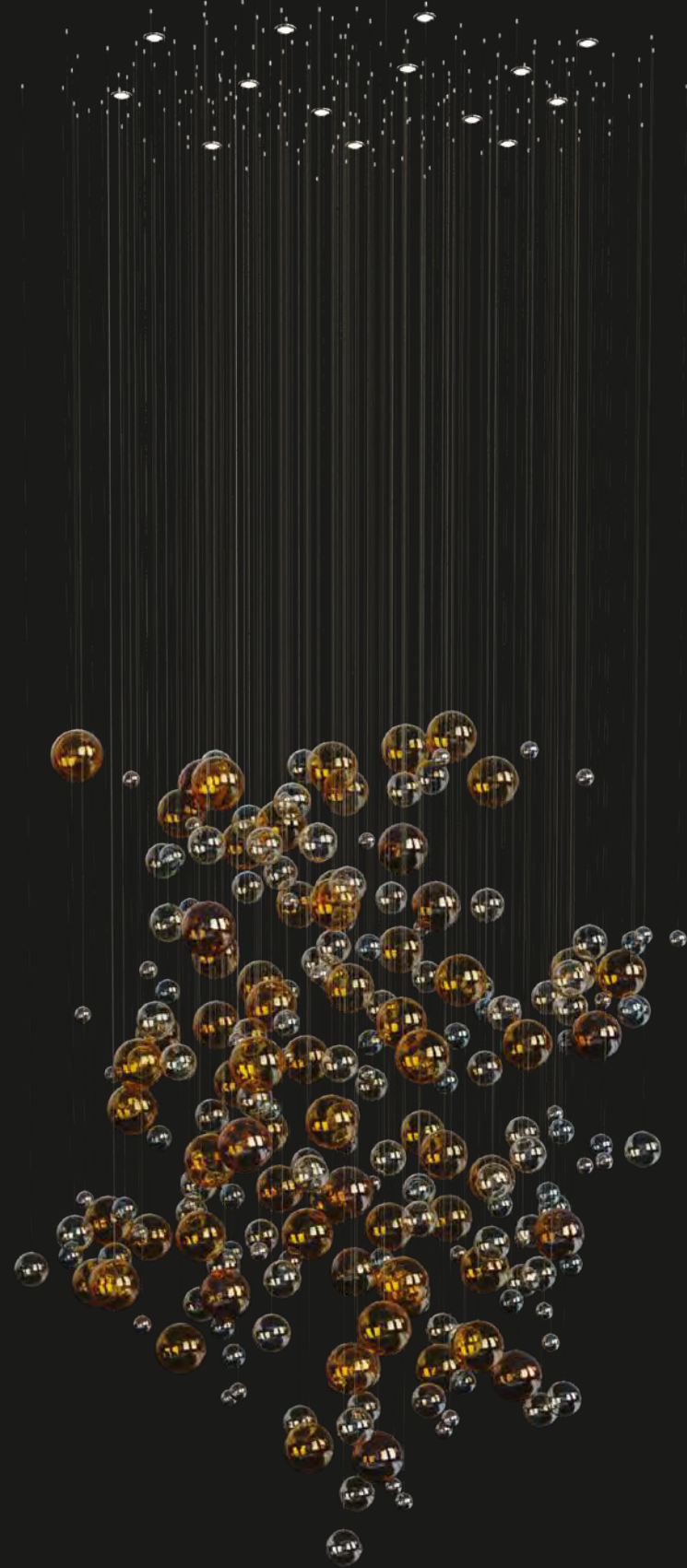

Lila

T776/A



W 254 cm - D 217 cm - h¹ 330 cm . W 100" - D 85" - h¹ 130"
14 Spotled 9W - 3000K





Kaleido



Kaleido

K800



W 301 cm - D 265 cm - h¹ 428 cm . W 118" - D 104" - h¹ 169"
25 Spotted 9W - 3000K - 95 Microled 0,28W - 3000K

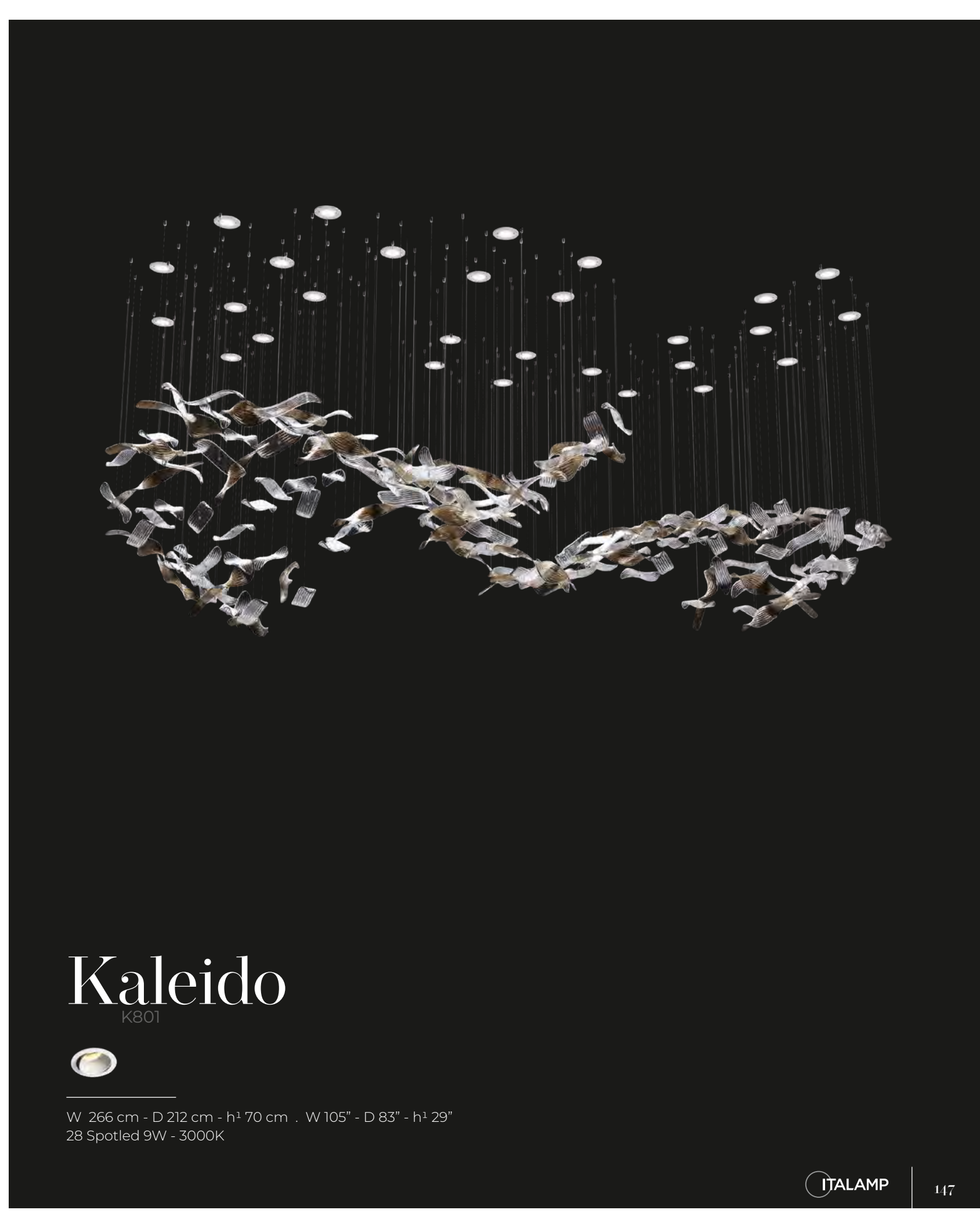

Kaleido

K801



W 266 cm - D 212 cm - h¹ 70 cm . W 105" - D 83" - h¹ 29"
28 Spotled 9W - 3000K

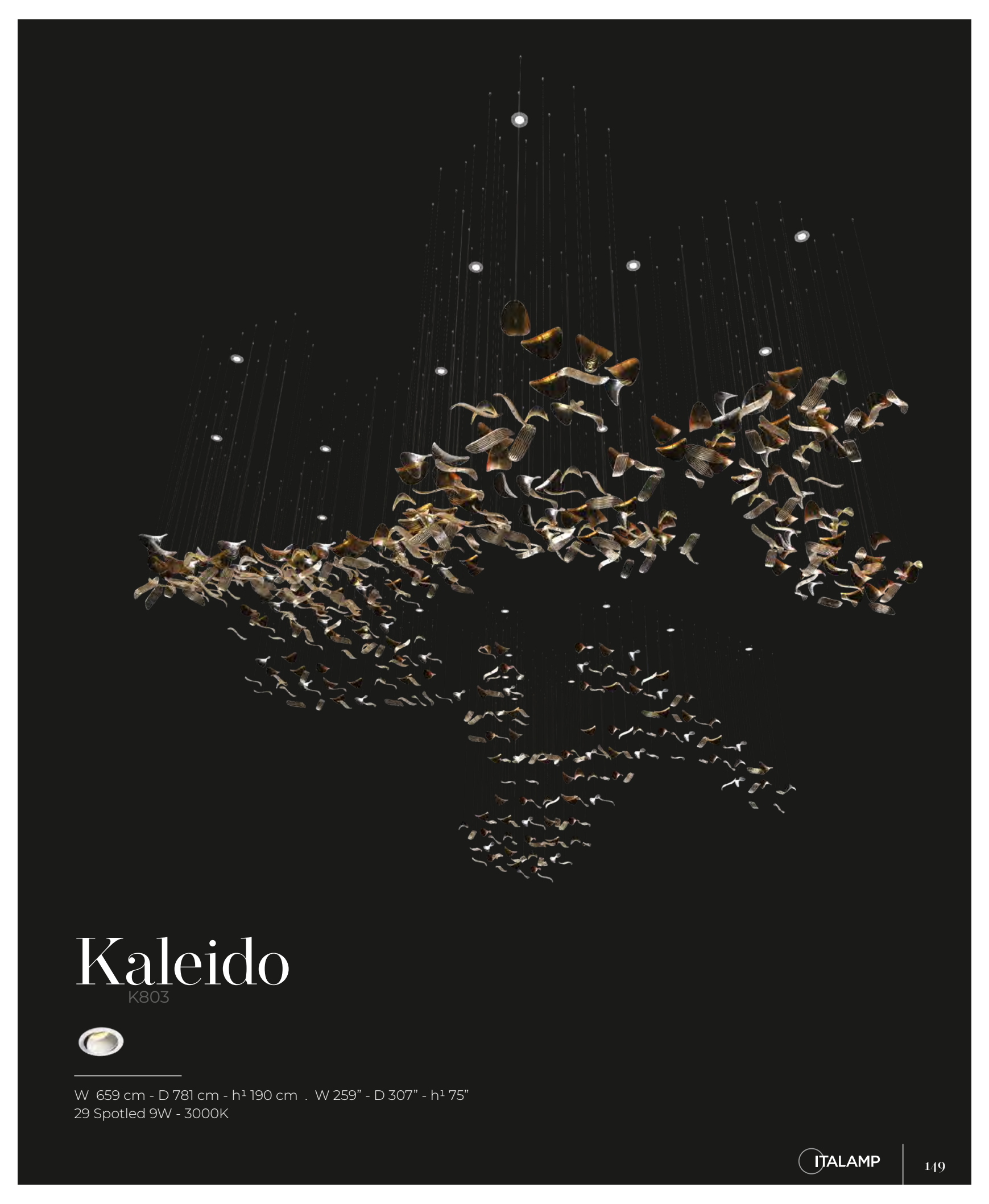

Kaleido

K803



W 659 cm - D 781 cm - h¹ 190 cm . W 259" - D 307" - h¹ 75"
29 Spotted 9W - 3000K



Kaleido

K804



W 190 cm - D 660 cm - h¹ 48 cm . W 75" - D 260" - h¹ 19"
24 Spotted 9W - 3000K

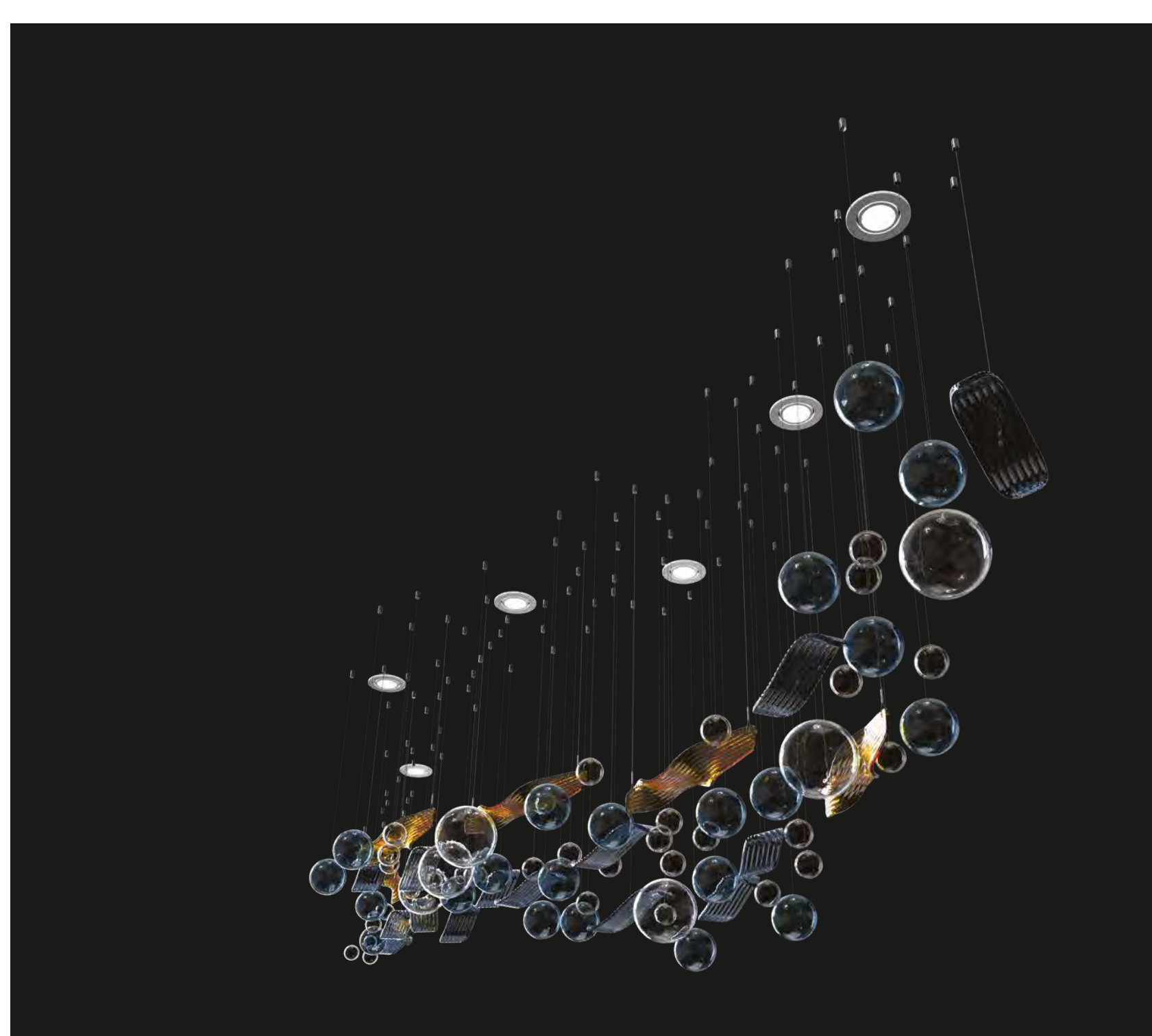

Kaleido

K804/A



W 296 cm - D 60 cm - h¹ 48 cm . W 113" - D 23" - h¹ 19"
6 Spotted 9W - 3000K

Kaleido Suggestions





Kaleido

K805



W 160 cm - D 650 cm - h¹ 70 cm . W 63" - D 256" - h¹ 28"
42 Spotted 9W - 3000K



Kaleido

K806



W 171 cm - D 159 cm - h¹ 70 cm . W 67" - D 63" - h¹ 28"
14 Spotled 9W - 3000K



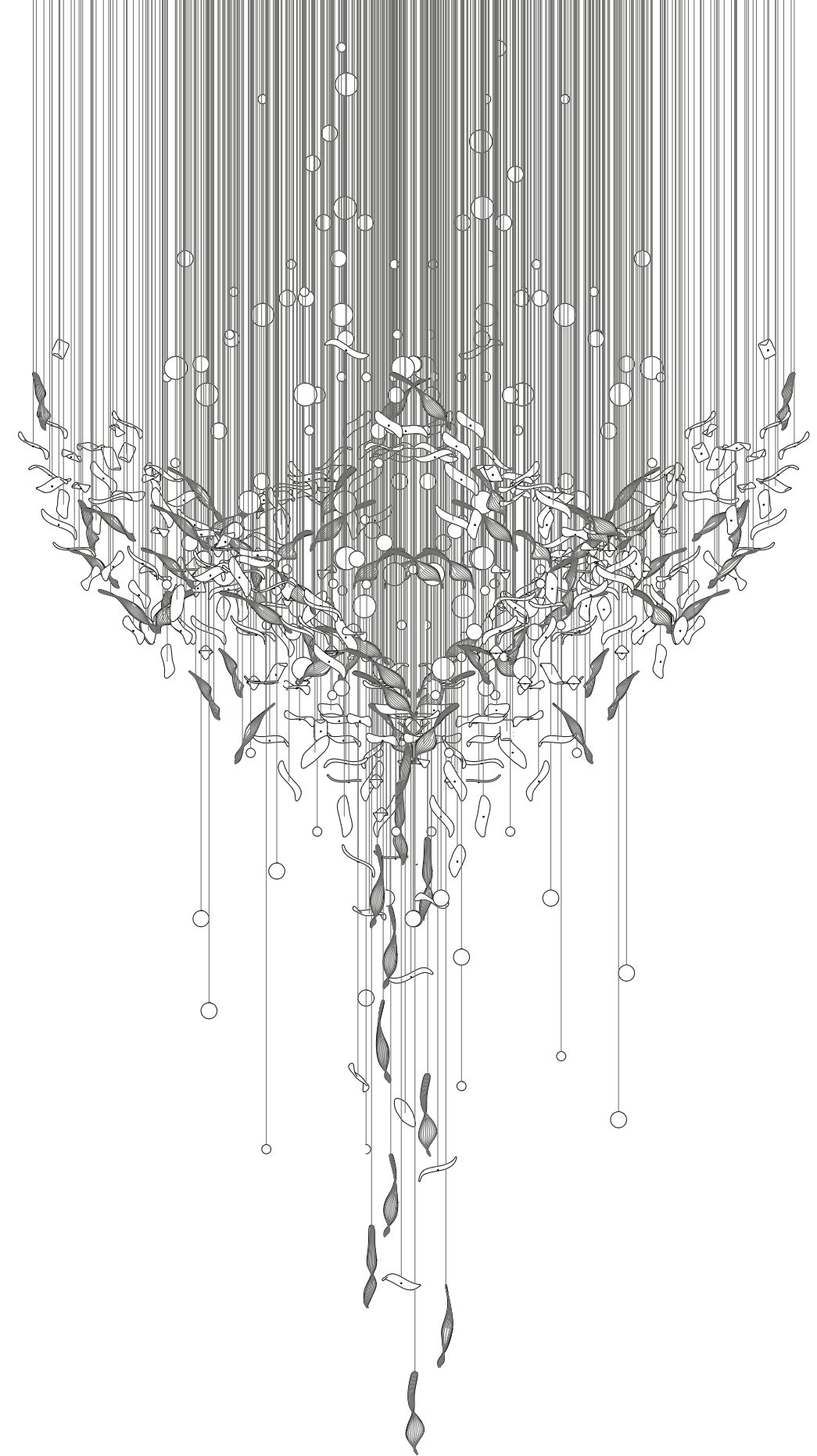

Kaleido

K807



W 344 cm - D 344 cm - h¹ 617 cm . W 135" - D 135" - h¹ 243"
24 Spotted 9W - 3000K

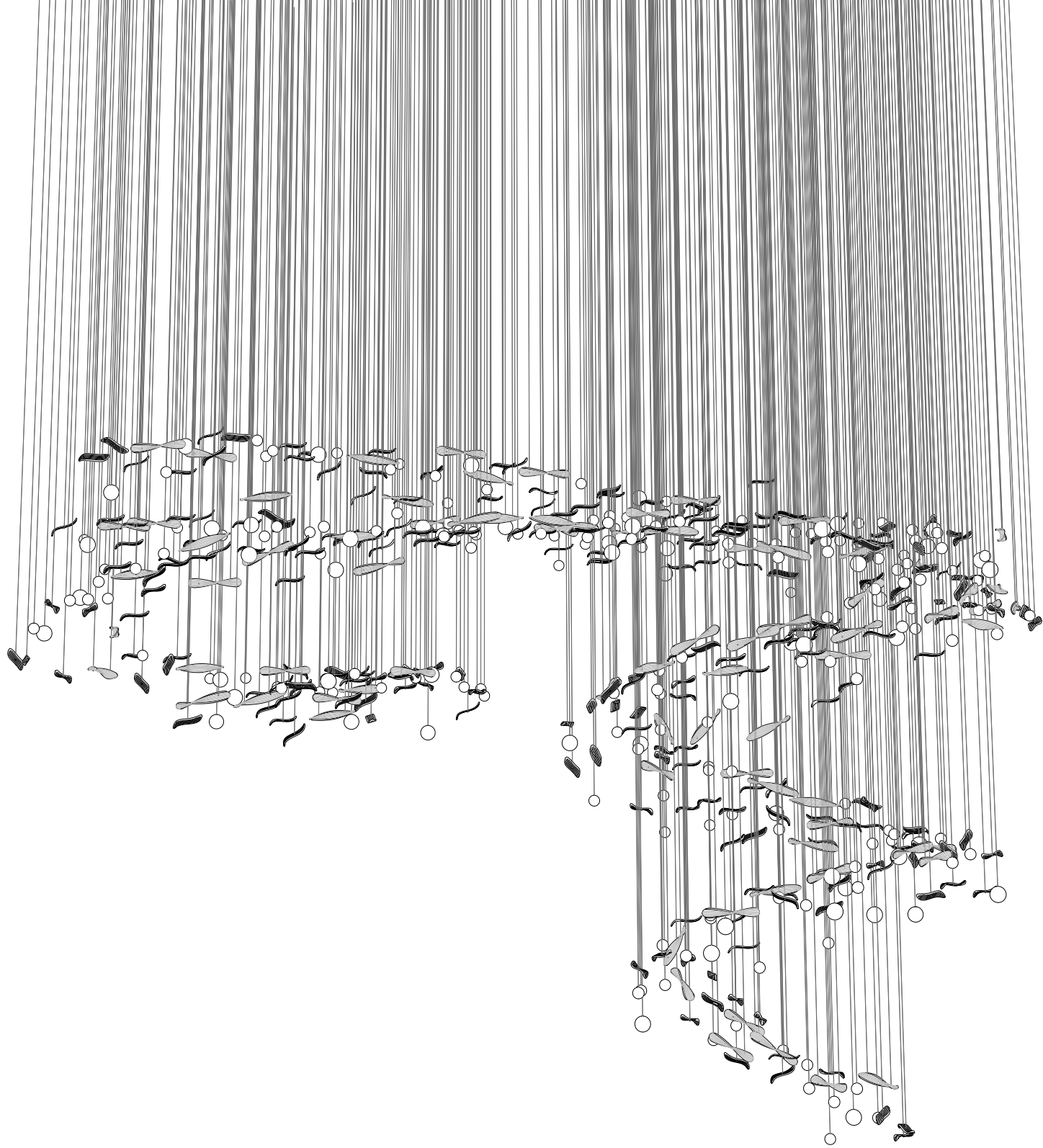

Kaleido

K810



W 664 cm - D 300 cm - h¹ 449 cm . W 261" - D 118" - h¹ 177"





Kaleido

K811



Ø 120 cm - h¹ 300 cm . Ø 47" - h¹ 118"
12 Spotted 9W - 3000K

Kaleido Technical sheets



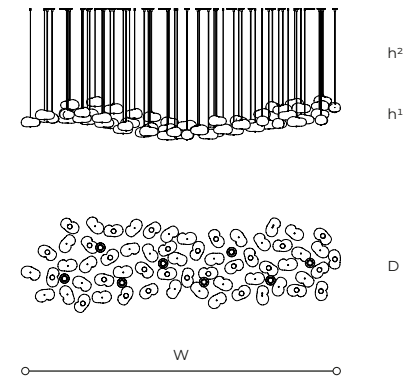
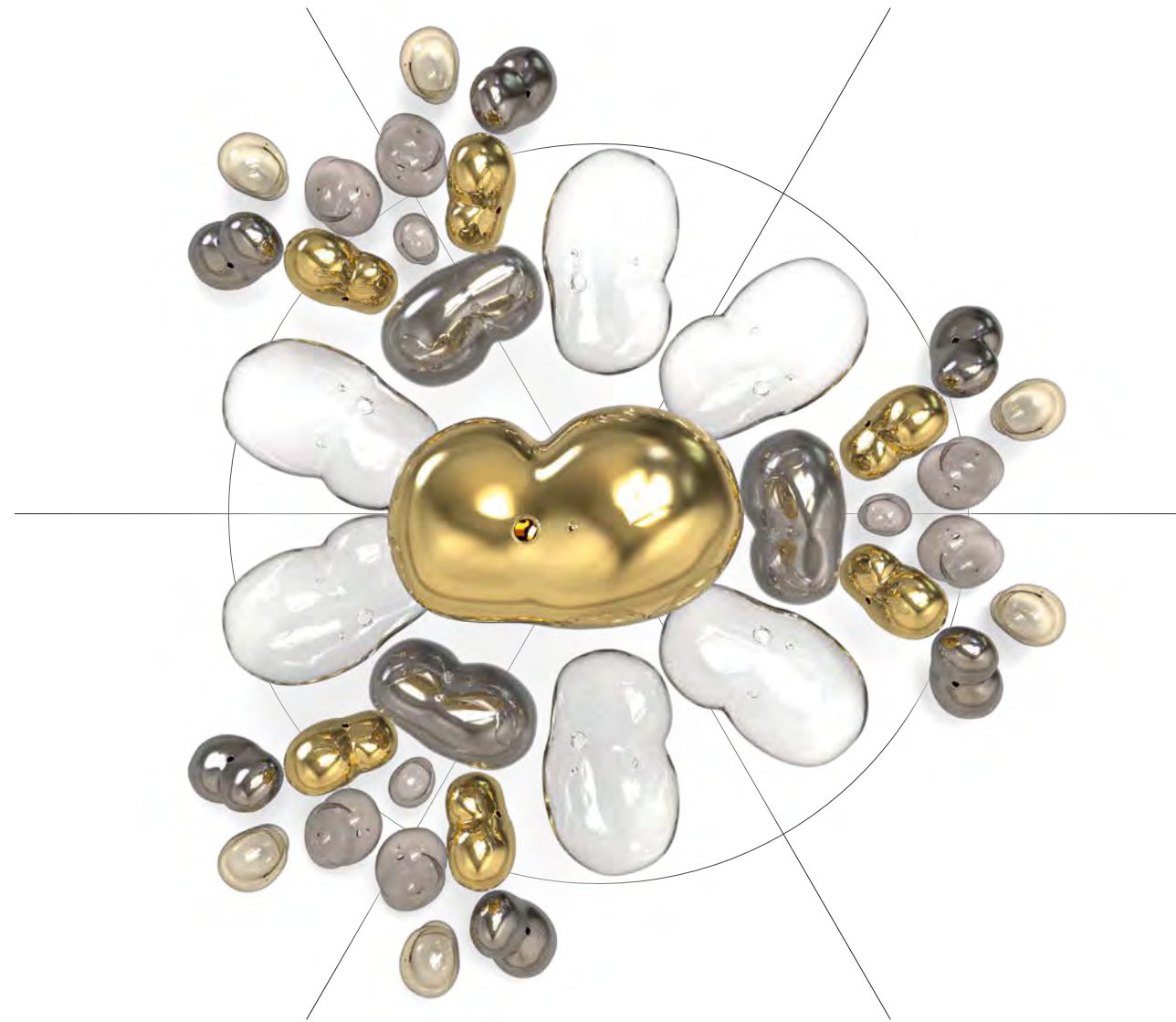

T774



W 273 cm - D 80 cm - h¹ 37 cm
W 107" - D 31" - h¹ 15"
8 Spotted 9W - 3000K
31 Microled 0,28W - 3000K

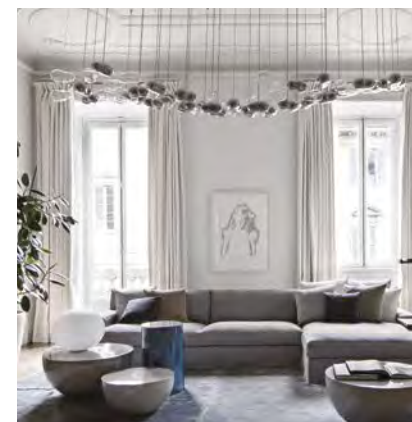

page 027

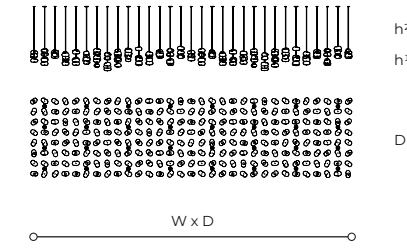

T774/A



W 741 cm - D 183 cm - h¹ 56 cm
W 292" - D 72" - h¹ 20"
31 Spotted 9W - 3000K
105 Microled 0,28W - 3000K



page 029

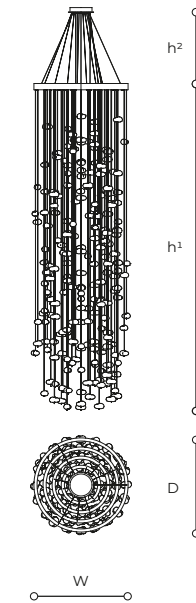

T774/B



W 160 cm - D 160 cm - h¹ 473 cm
W 63" - D 63" - h¹ 186"
21 Spotted 9W - 3000K
84 Microled 0,28W - 3000K



page 031

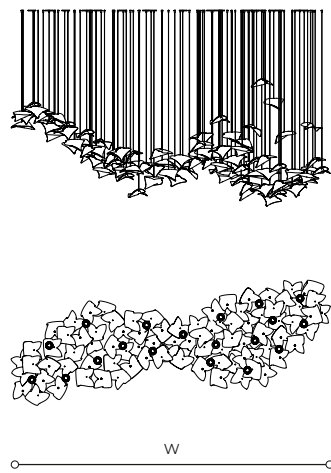

T766 - T766/D



W 339 cm - D 139 cm - h¹ 137 cm
W 133" - D 55" - h¹ 54"
19 Spotted 9W - 3000K
41 Microled 0,28W - 3000K

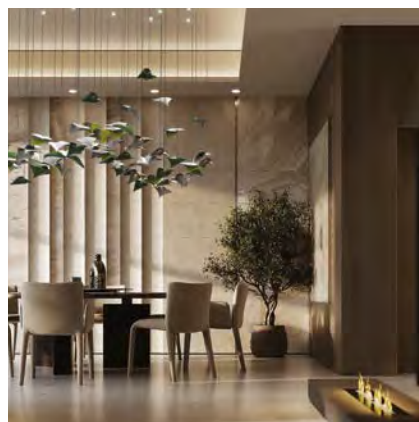

page 037

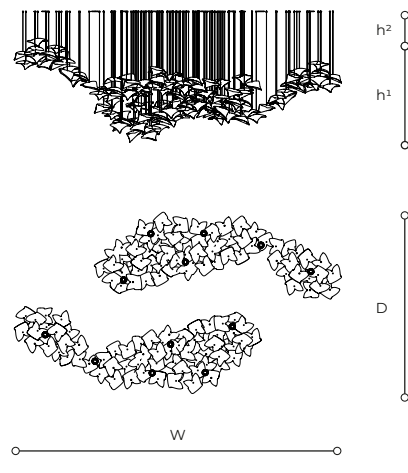

T766/A



W 420 cm - D 208 cm - h¹ 101 cm
W 165" - D 90" - h¹ 40"
12 Spotted 9W - 3000K
35 Microled 0,28W - 3000K



page 039

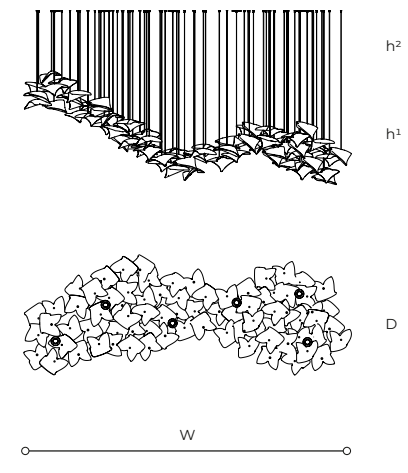

T766/B



W 300 cm - D 111 cm - h¹ 106 cm
W 118" - D 44" - h¹ 42"
6 Spotted 9W - 3000K
28 Microled 0,28W - 3000K



page 041

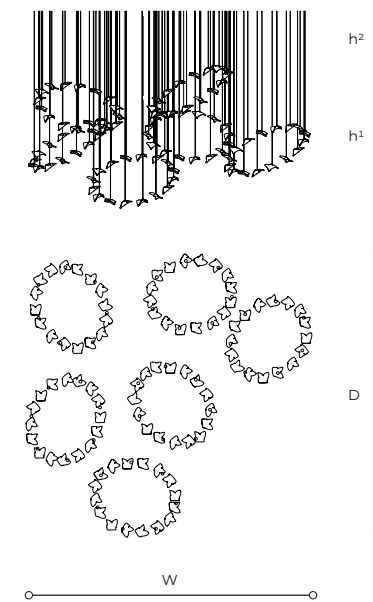

T766/C



W 557 cm - D 510 cm - h¹ 260 cm
W 219" - D 200" - h¹ 102"
42 Spotted 9W - 3000K
90 Microled 0,28W - 3000K



page 045

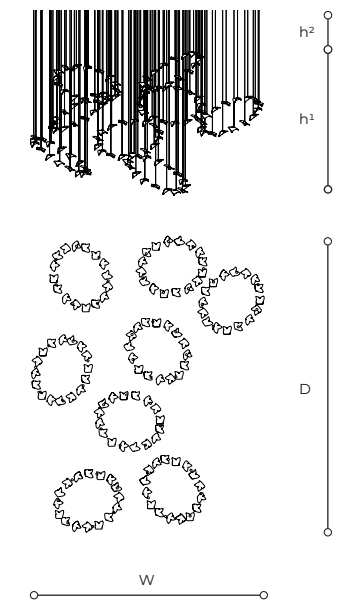

T766/C1



W 557 cm - D 806 cm - h¹ 348 cm
W 219" - D 317" - h¹ 137"
56 Spotted 9W - 3000K
105 Microled 0,28W - 3000K



page 043

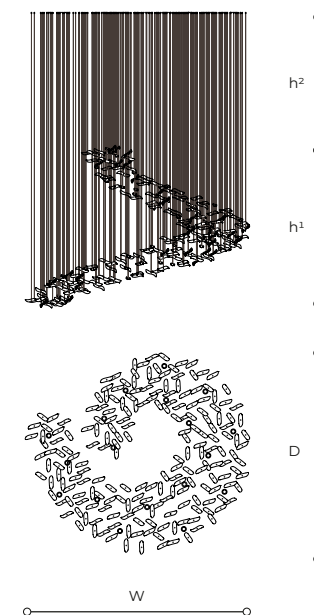
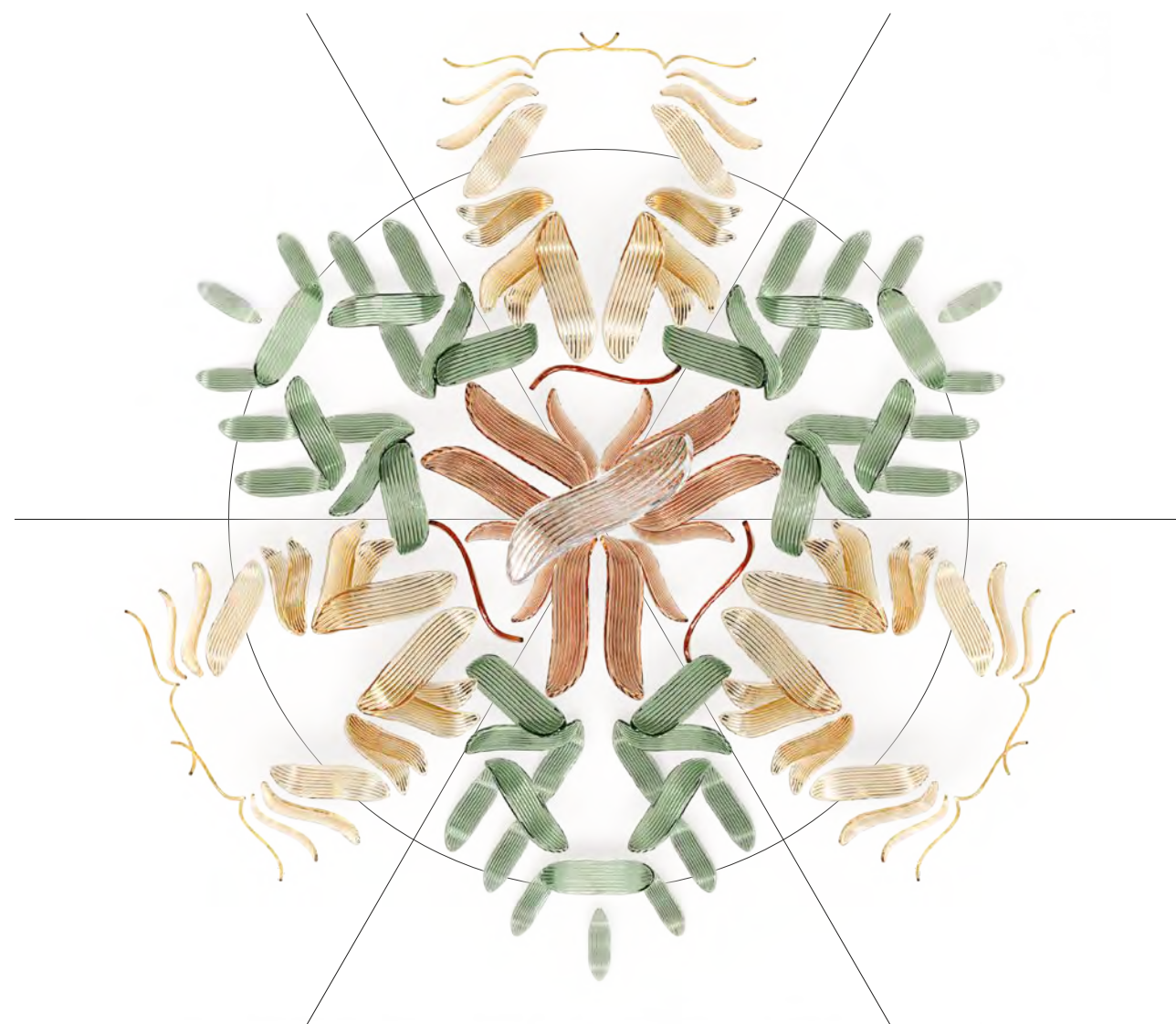

T750



W 294 cm - D 294 cm - h¹ 239 cm
 W 116" - D 116" - h¹ 94"
 18 Spotted 9W - 3000K

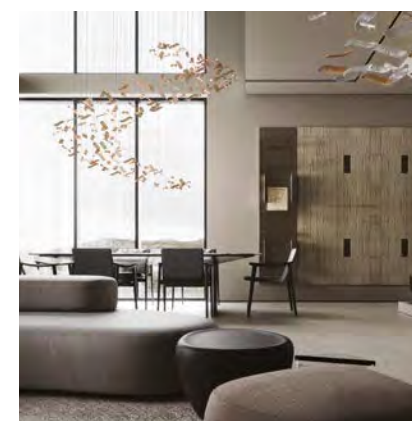

page 053

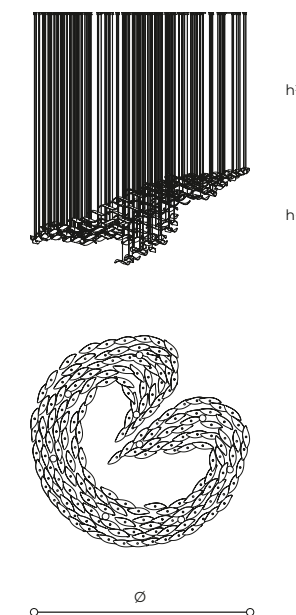

T750/A



Ø 160 cm - h¹ 72 cm
 Ø 62" - h¹ 28"
 9 Spotted 9W - 3000K



page 062

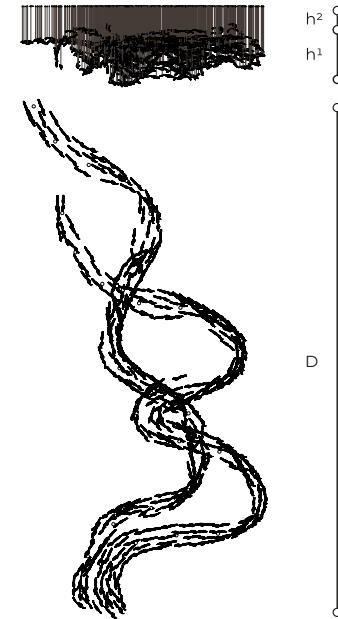
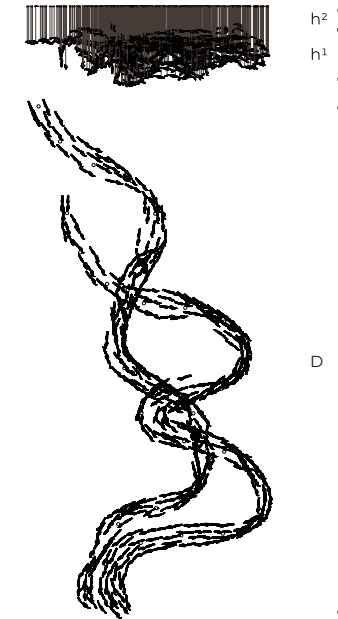
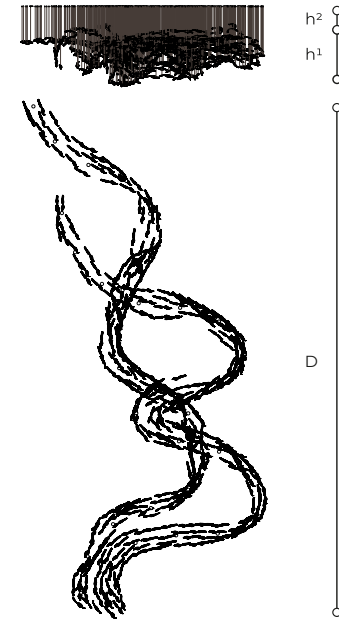

T764



W 1132 cm - D 533 cm - h¹ 138 cm
 W 446" - D 210" - h¹ 54"
 35 Spotled 9W - 3000K



page 059

T764



W 1132 cm - D 533 cm - h¹ 138 cm
 W 446" - D 210" - h¹ 54"
 35 Spotled 9W - 3000K

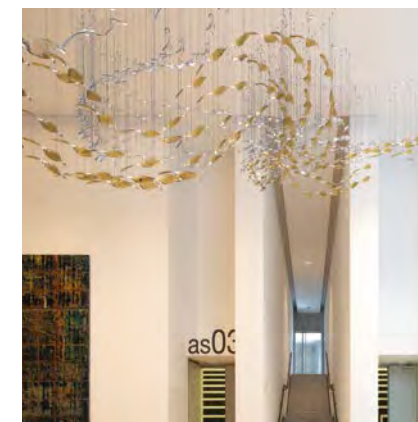

page 065

T764



W 1132 cm - D 533 cm - h¹ 138 cm
 W 446" - D 210" - h¹ 54"
 35 Spotled 9W - 3000K

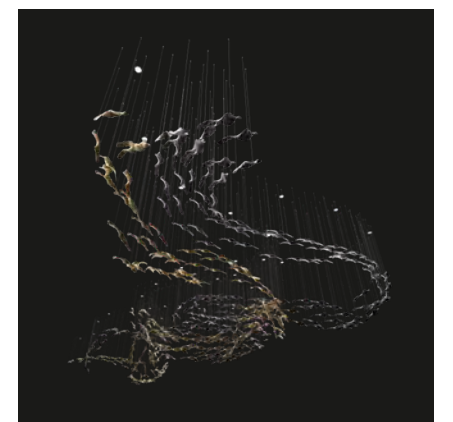

page 63

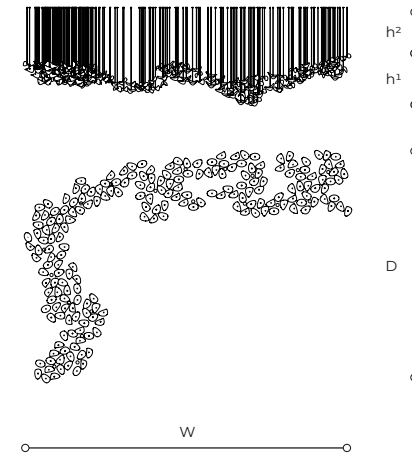

T770



W 520 cm - D 365 cm - h¹ 80 cm
 W 205" - D 144" - h¹ 32"
 23 Spotled 9W - 3000K
 100 Microled 0,28W - 3000K



page 071

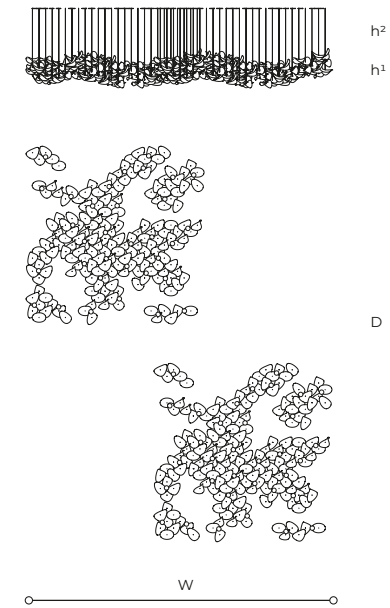

T770/A



W 345 cm - D 445 cm - h¹ 50 cm
 W 136" - D 175" - h¹ 12"
 48 Spotled 9W - 3000K

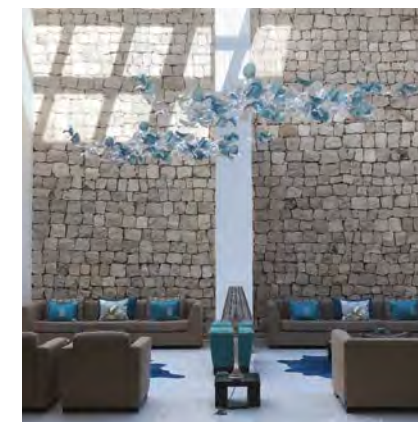

page 073

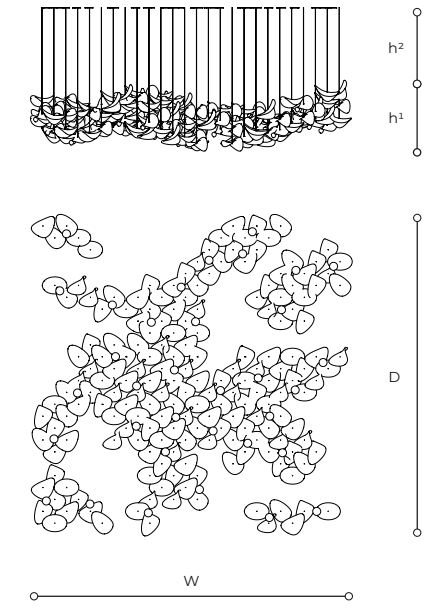

T770/B



W 200 cm - D 200 cm - h¹ 50 cm
 W 50" - D 50" - h¹ 12"
 24 Spotled 9W - 3000K

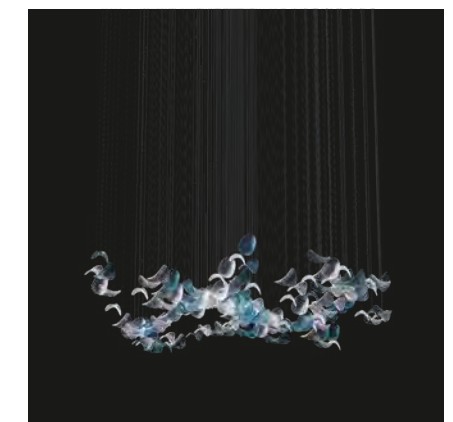

page 075

Technical Sheets
Flora

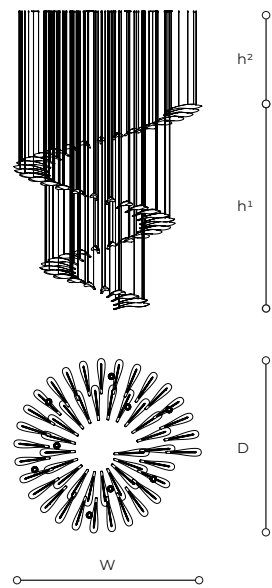

T760



W 236 cm - D 236 cm - h¹ 260 cm
 W 93" - D 93" - h¹ 102"
 9 Spotted 9W - 3000K



page 083

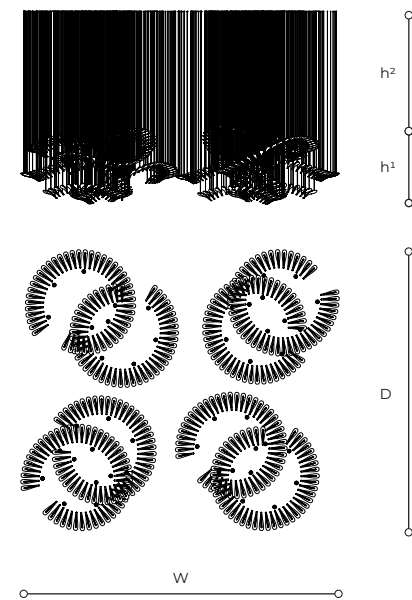

T760/A



W 718 cm - D 685 cm - h¹ 174 cm
 W 283" - D 270" - h¹ 68"
 48 Spotted 9W - 3000K

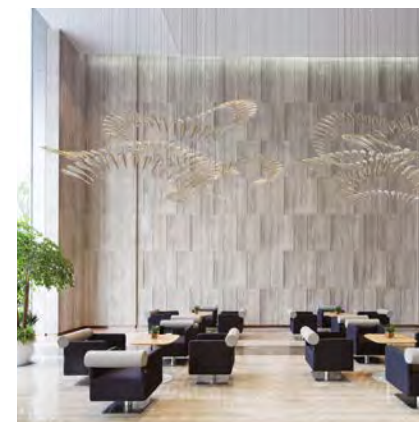

page 085

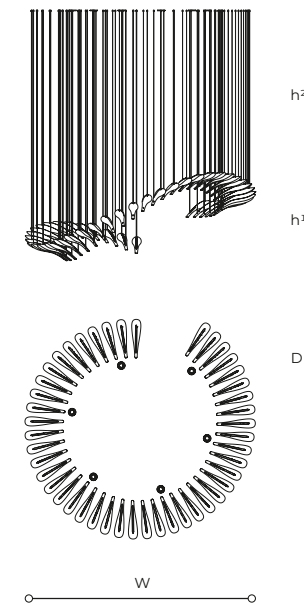

T760/B



W 252 cm - D 252 cm - h¹ 95 cm
 W 99" - D 99" - h¹ 37"
 8 Spotted 9W - 3000K

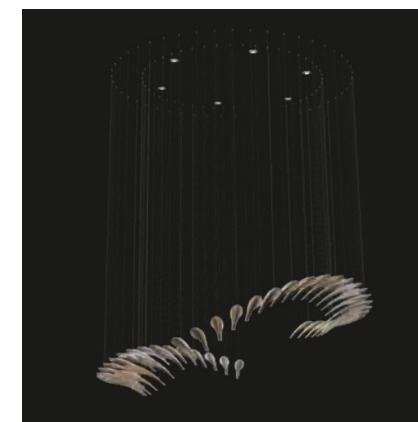

page 087



T760/C



W 644 cm - D 434 cm - h¹ 556 cm
 W 254" - D 171" - h¹ 219"
 29 Spotted 9W - 3000K



page 089

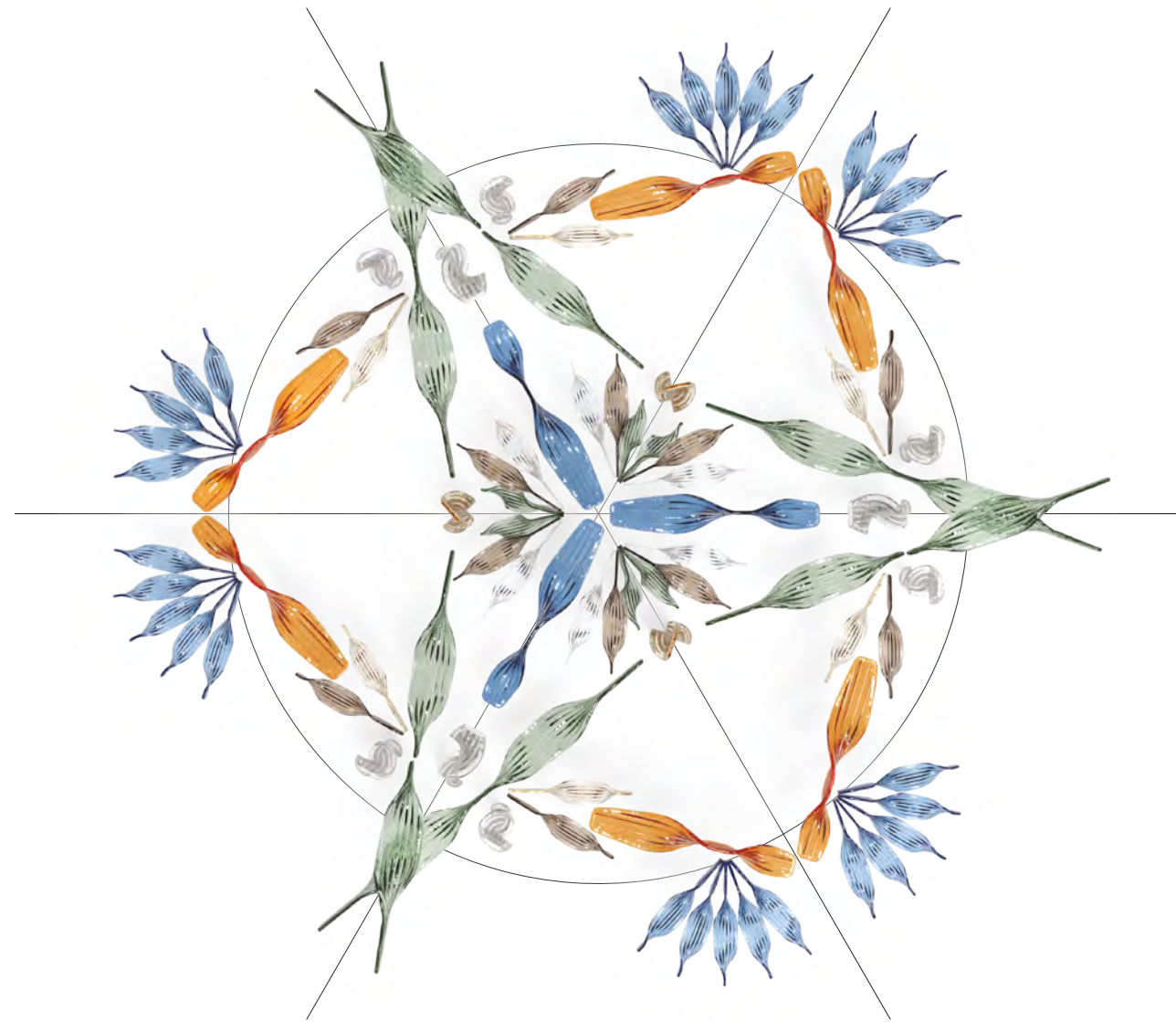

T754



W 237 cm - D 222 cm - h¹ 298 cm
 W 93" - D 87" - h¹ 115"
 15 Spotted 9W - 3000K

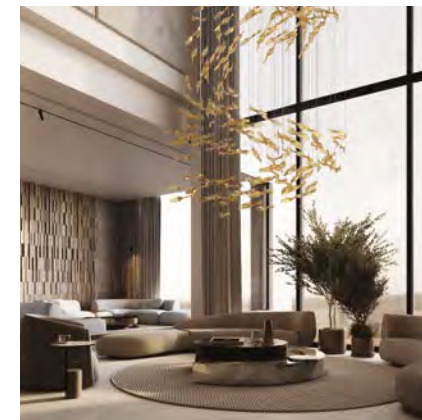

page 095

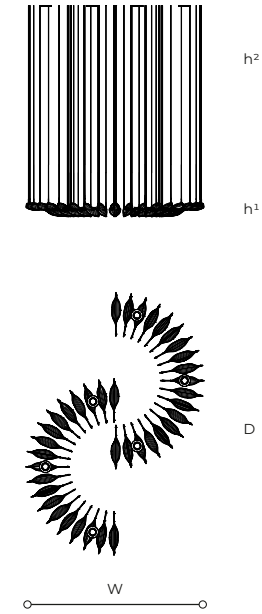

T754/A



W 121 cm - D 179 cm - h¹ 20 cm
 W 48" - D 70" - h¹ 8"
 6 Spotted 9W - 3000K



page 096

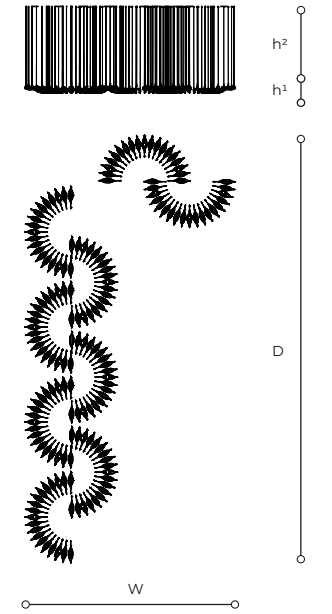

T754/B



W 385 cm - D 618 cm - h¹ 20 cm
 W 151" - D 243" - h¹ 8"
 27 Spotted 9W - 3000K



page 097

Technical Sheets
Marina

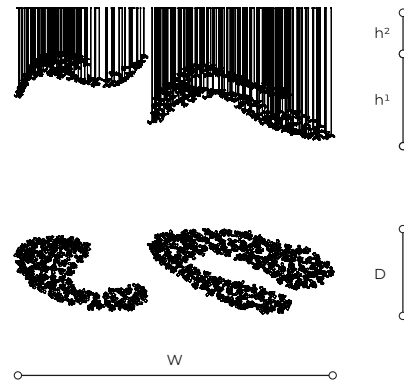
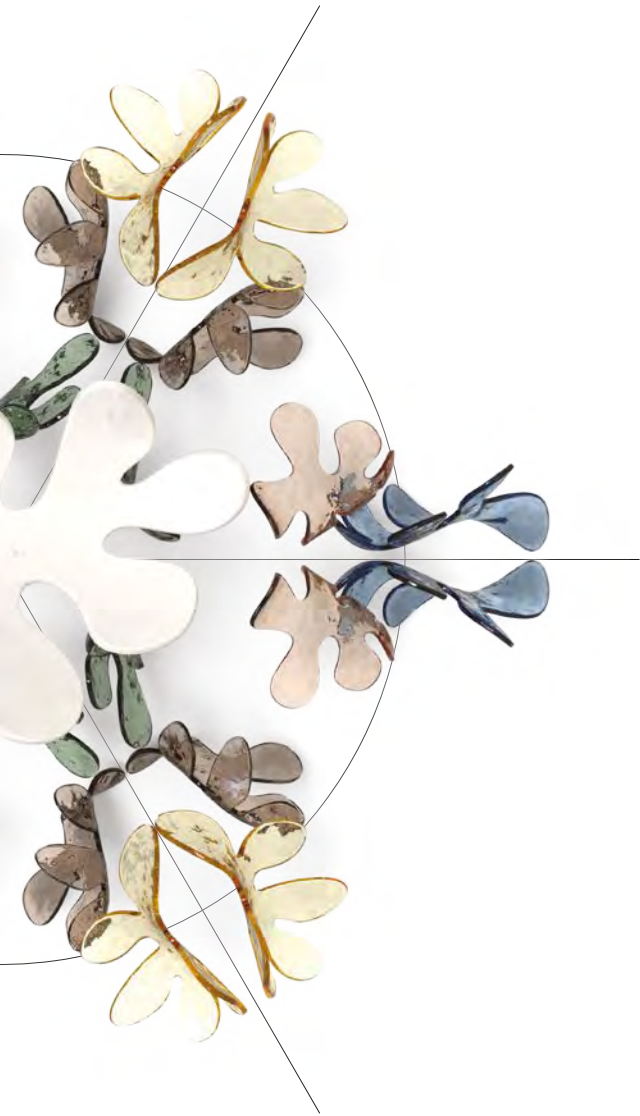

T762



W 882 cm - D 241 cm - h¹ 242 cm
 W 347" - D 95" - h¹ 95"
 36 Spotted 9W - 3000K

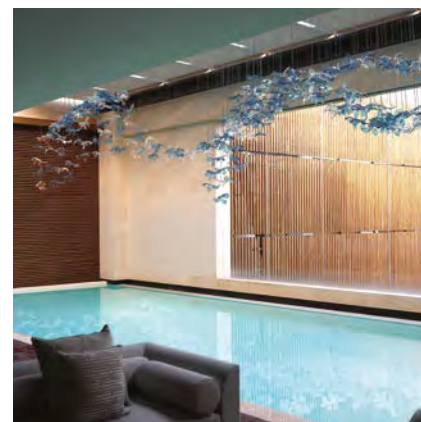

page 105

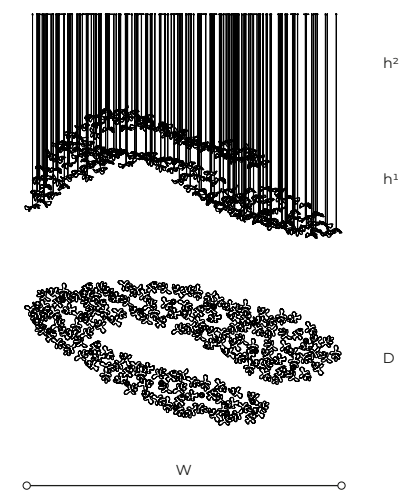

T762/A



W 501 cm - D 240 cm - h¹ 213 cm
 W 197" - D 94" - h¹ 84"
 19 Spotted 9W - 3000K

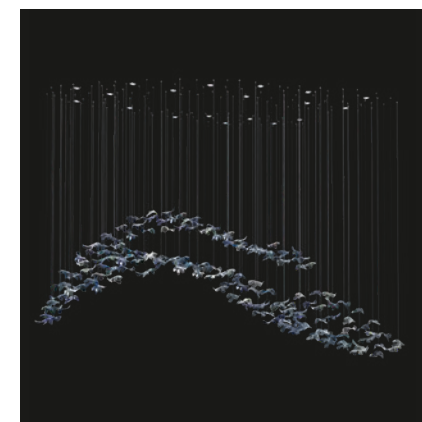

page 106

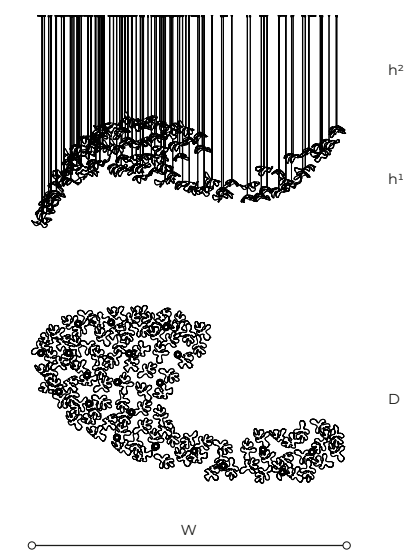

T762/B



W 365 cm - D 203 cm - h¹ 133 cm
 W 54" - D 80" - h¹ 52"
 20 Spotted 9W - 3000K

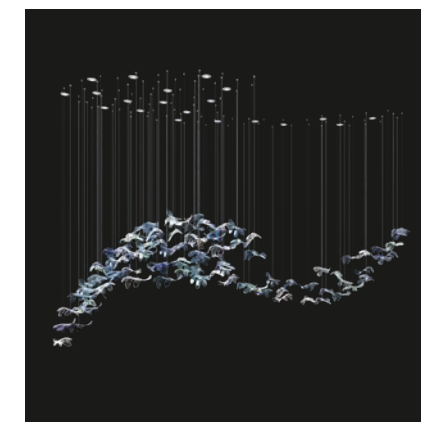

page 107

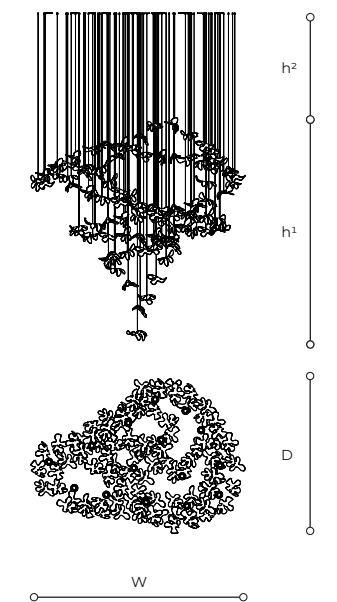

T762/C



W 244 cm - D 174 cm - h¹ 254 cm
 W 96" - D 69" - h¹ 100"
 16 Spotted 9W - 3000K

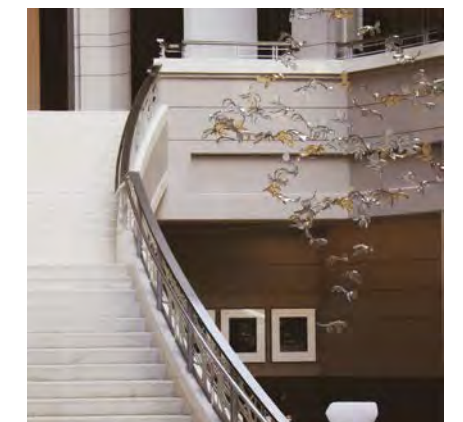

page 109

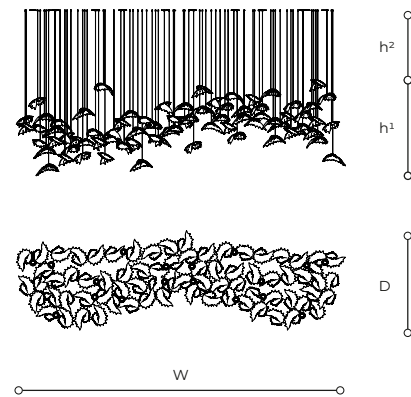

T756



W 433 cm - D 130 cm - h¹ 124 cm
 W 170" - D 51" - h¹ 49"
 18 Spotted 9W - 3000K



page 123

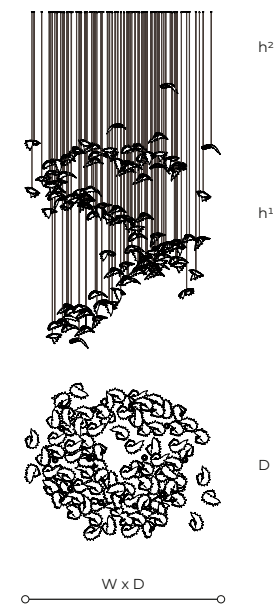

T756/A



W 289 cm - D 240 cm - h¹ 385 cm
 W 114" - D 94" - h¹ 152"
 12 Spotted 9W - 3000K
 53 Microled 0,28W - 3000K



page 115-117

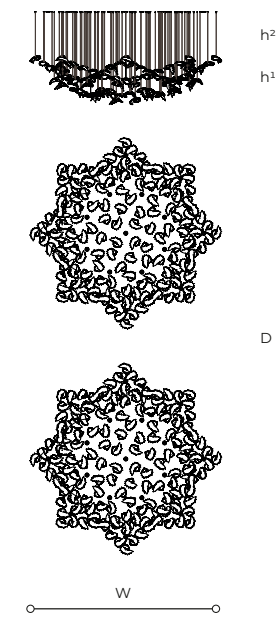

T756/C



W 400 cm - D 1000 cm - h¹ 104 cm
 W 157" - D 397" - h¹ 41"
 34 Spotted 9W - 3000K
 79 Microled - 3000K

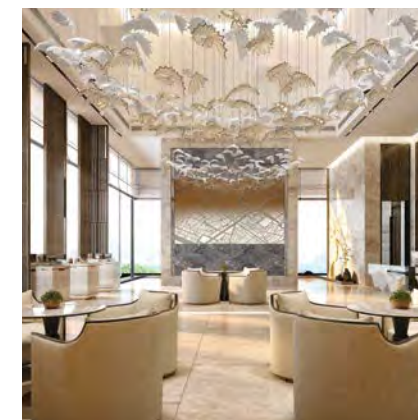

page 119

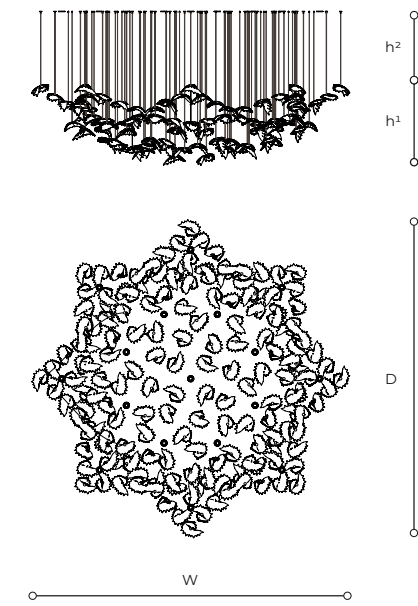

T756/D



W 400 cm - D 400 cm - h¹ 104 cm
 W 157" - D 157" - h¹ 41"
 17 Spotted 9W - 3000K
 79 Microled - 3000K

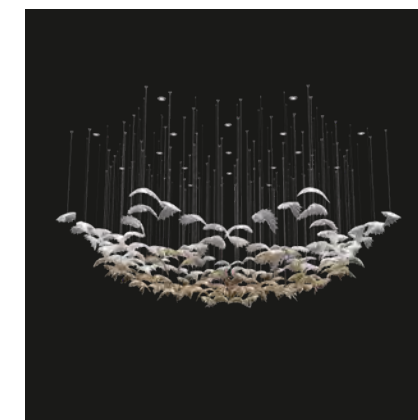

page 121

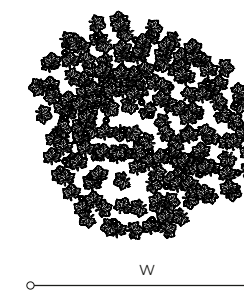
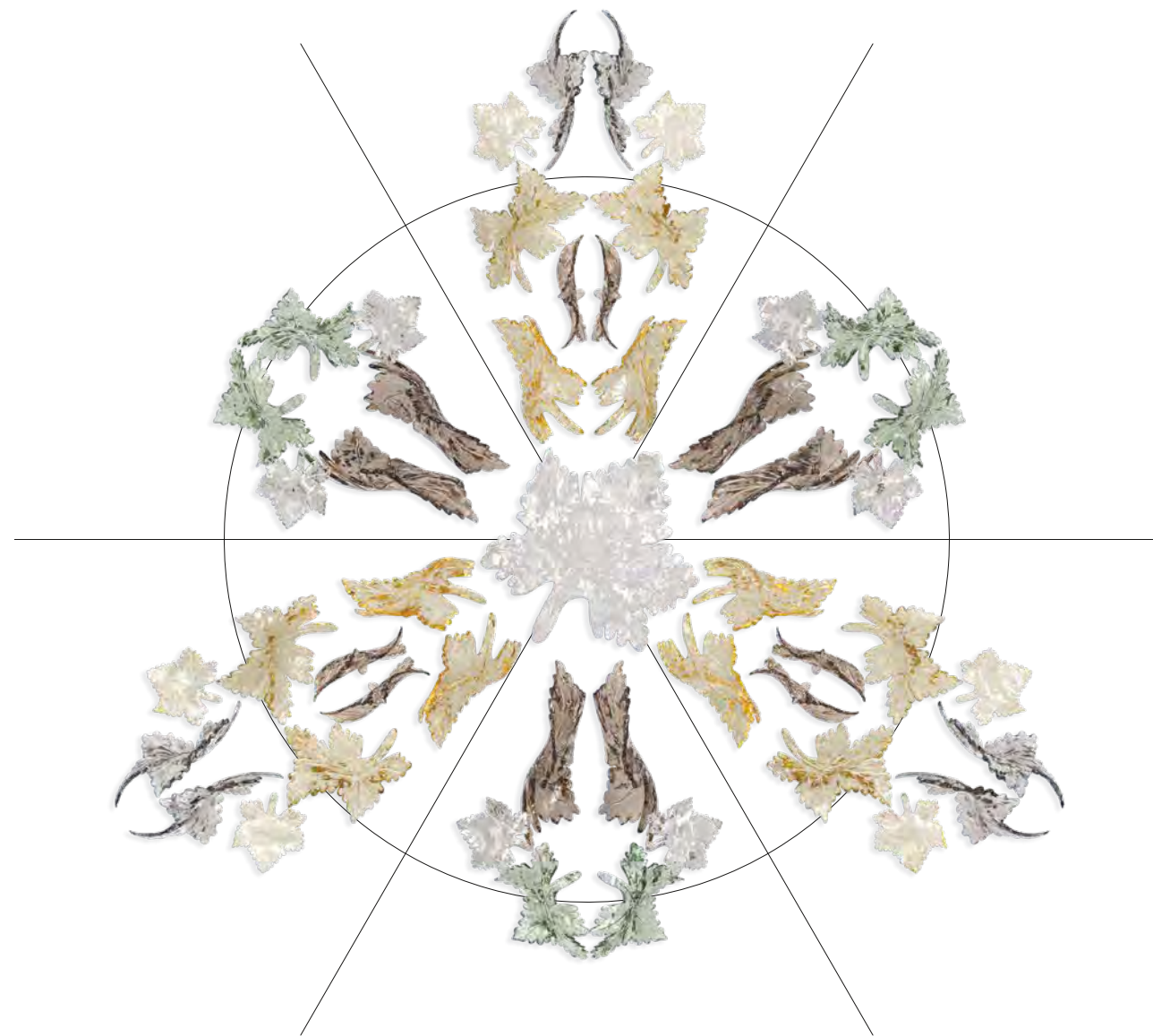

T752



W 300 cm - D 300 cm - h¹ 220 cm
 W 118" - D 118" - h¹ 87"
 24 Spotted 9W - 3000K



page 131

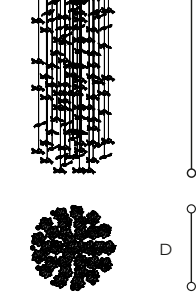
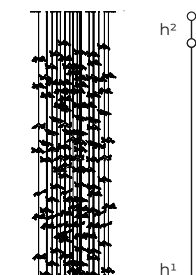

T752/A



W 200 cm - D 200 cm - h¹ 800 cm
 W 79" - D 79" - h¹ 315"
 16 Spotted 9W - 3000K



page 133

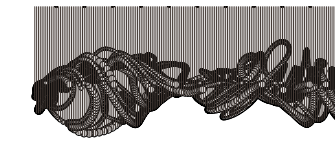
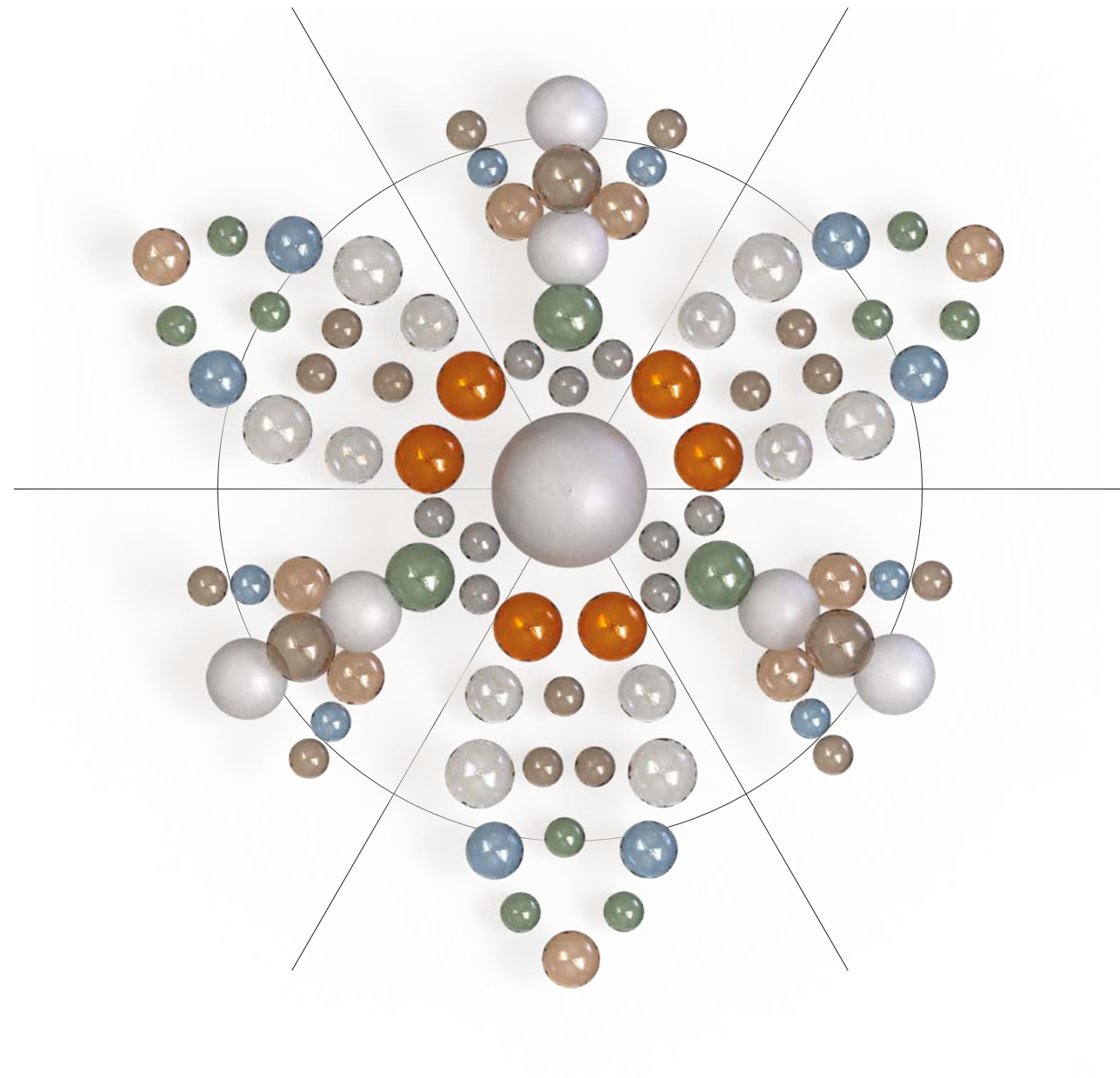

h²
h¹

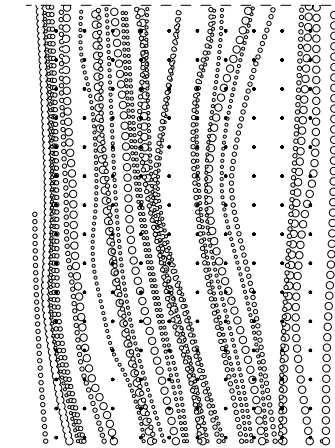

D

W

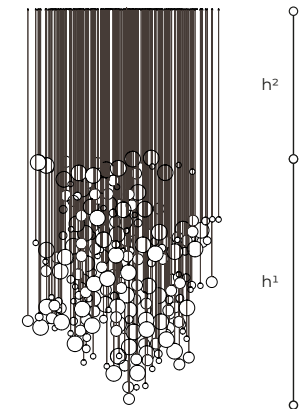

h²
h¹

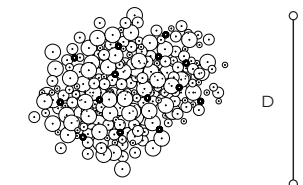

D

W

T776



W 1200 cm - D 5000 cm - h¹ 300 cm
W 472" - D 197" - h¹ 118"
530 Spotted 9W - 3000K

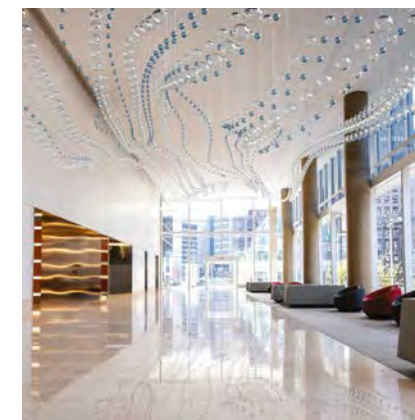

page 139

T776/A



W 254 cm - D 217 cm - h¹ 330 cm
W 100" - D 85" - h¹ 130"
14 Spotted 9W - 3000K

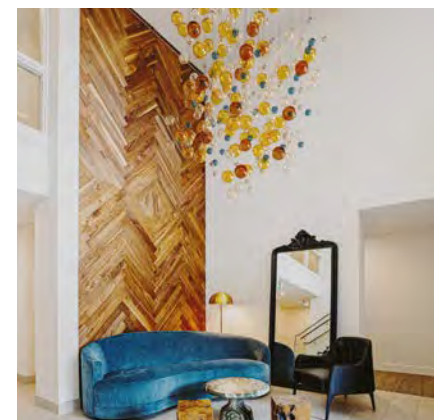

page 141

Technical Sheets
Kaleido

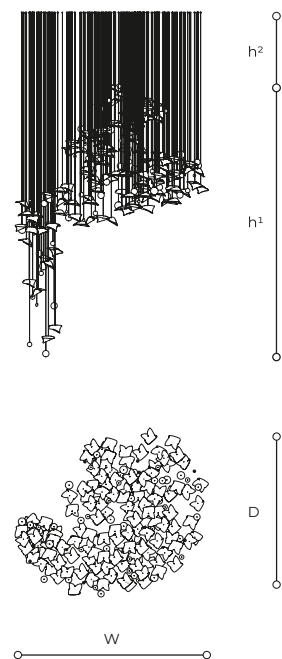

K800



W 301 cm - D 265 cm - h¹ 428 cm
 W 118" - D 104" - h¹ 169"
 25 Spotled 9W - 3000K
 95 Microled 0,28W - 3000K



page 147

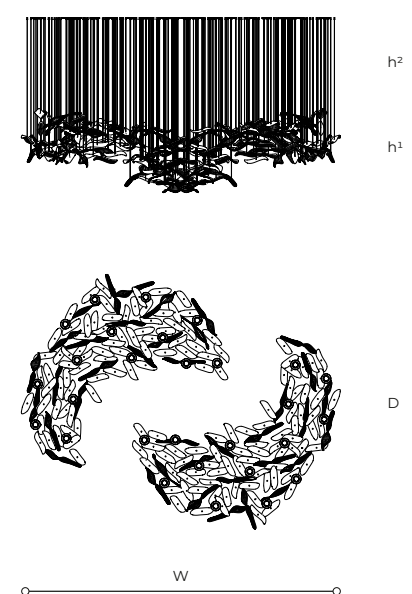

K801



W 266 cm - D 212 cm - h¹ 70 cm
 W 105" - D 83" - h¹ 29"
 28 Spotled 9W - 3000K

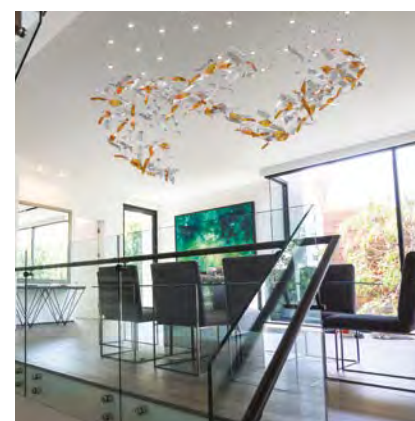

page 149

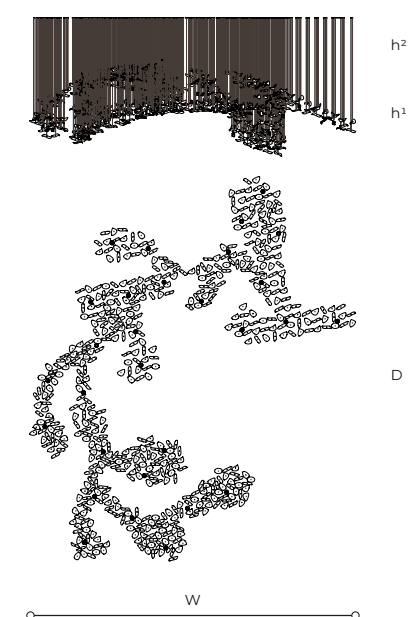

K803



W 659 cm - D 781 cm - h¹ 190 cm
 W 259" - D 307" - h¹ 75"
 29 Spotled 9W - 3000K

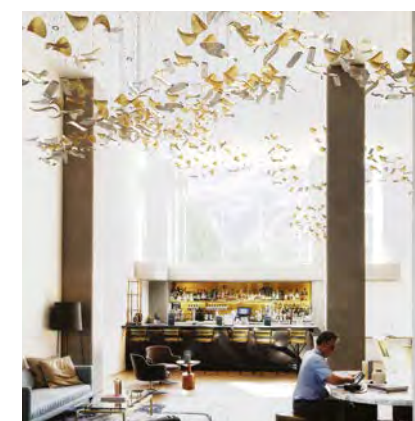

page 151



K804



W 190 cm - D 660 cm - h¹ 48 cm
 W 75" - D 260" - h¹ 19"
 24 Spotled 9W - 3000K

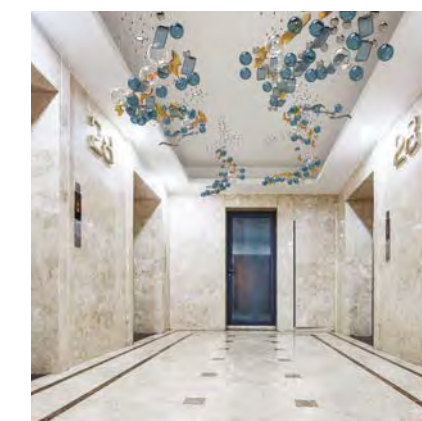

page 152

Technical Sheets
Kaleido

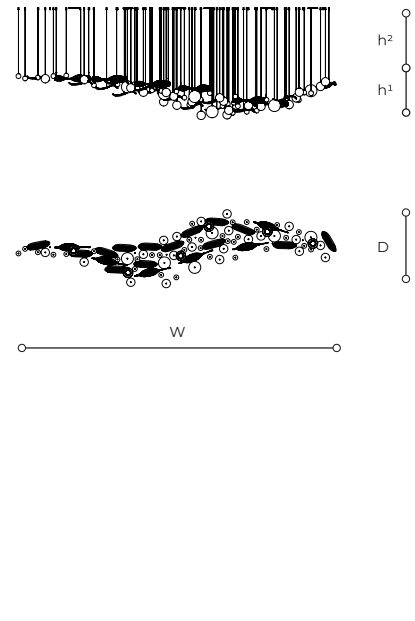

K804/A



W 296 cm - D 60 cm - h¹ 48 cm
 W 113" - D 23" - h¹ 19"
 6 Spotted 9W - 3000K



page 153

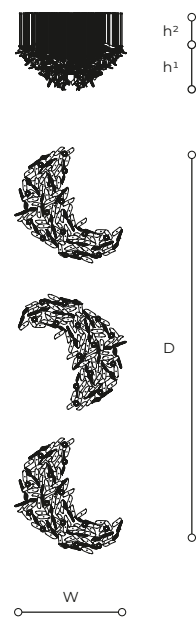

K805



W 160 cm - D 650 cm - h¹ 70 cm
 W 63" - D 256" - h¹ 28"
 42 Spotted 9W - 3000K



page 157

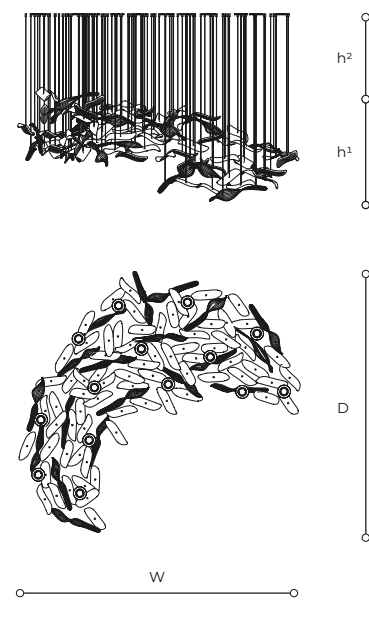

K806



W 171 cm - D 159 cm - h¹ 70 cm
 W 67" - D 63" - h¹ 28"
 14 Spotted 9W - 3000K



page 159

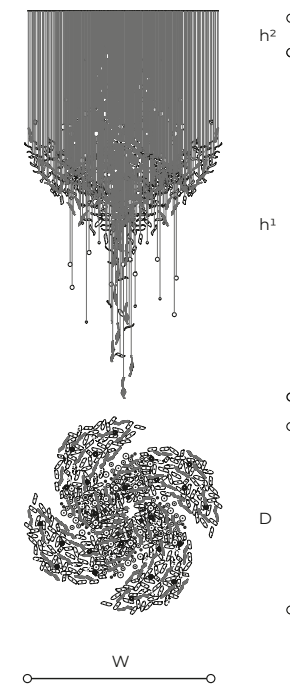

K807



W 344 cm - D 344 cm - h¹ 617 cm
 W 135" - D 135" - h¹ 243"
 24 Spotted 9W - 3000K

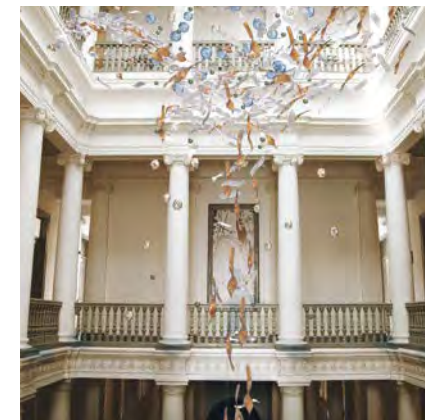

page 161

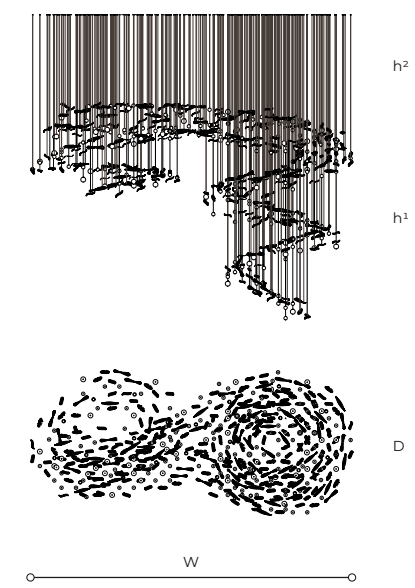

K810

W 664 cm - D 300 cm - h¹ 449 cm
 W 261" - D 118" - h¹ 177"

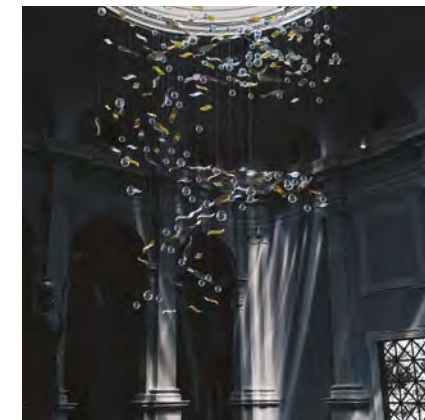

page 163

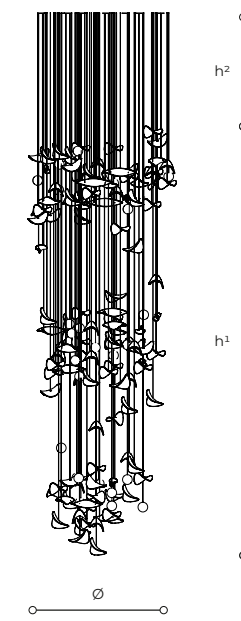

K811



Ø 120 cm - h¹ 300 cm
 Ø 47" - h¹ 118"
 12 Spotted 9W - 3000K



page 165

○ . COLOPHON

Ogni prodotto Italamp è corredato di una documentazione contenente tra l'altro il certificato di autenticità e la scheda di collaudo. In caso di reclamo il cliente dovrà sempre fornire copia della scheda. Sulla scheda sono contenute anche le istruzioni per un corretto montaggio dell'articolo.

Italamp non risponde per eventuali danni a persone o cose causati da una non corretta installazione dei propri apparecchi di illuminazione, da un uso di lampadine non conformi e dalla modificazione delle caratteristiche tecnico costruttive.

La ditta si riserva di apportare ai modelli ogni modifica estetica e tecnica che a suo insindacabile giudizio ritenga necessaria.

Il marchio **CE** è un marchio europeo di garanzia che certifica la qualità del prodotto e la sua rispondenza ai parametri di sicurezza previsti dalle normative CEE.

Italamp può fornire per la quasi totalità dei suoi articoli la certificazione con marchio UL. In tutto il mondo UL testa prodotti secondo i requisiti di sicurezza statunitensi per un accesso sicuro ovunque nel Nord America. UNI EN ISO 9001/2015 certifica in maniera stabile l'alta qualità e la grande affidabilità di tutti i processi produttivi aziendali della produzione Italtamp. Italtamp è un marchio registrato.

ATTENZIONE: I colori visualizzati, per noti motivi tecnici, sono indicativi e possono differire dall'originale: la reazione dei colori, vetri, texture, vernici e metalli varia a seconda dello spessore e delle dimensioni complessive del prodotto ma soprattutto della luce che batte sulla superficie complessiva. ITALAMP si riserva il diritto di apportare ai prodotti le modifiche che riterrà più opportune, in qualsiasi momento e senza preavviso.

Tutti i nostri modelli sono depositati e quindi coperti da brevetto.

Questo catalogo è tutelato dalla legge sui diritti d'autore (legge 22/4/1941 n°633 e dalla legge 14/12/1942 n°1485).

È vietata ogni riproduzione anche parziale dello stesso.

produced by
ITALAMP S.R.L.
All right reserved

No part of this publication may be reproduced or transmitted in any form or by any means, electronic or mechanical, including photocopying, recording or any information storage and retrieval system, without permission in writing from publisher.

graphic project
S. TRAVERSO / ITALAMP STUDIO

copy
ITALAMP STUDIO

photo
ITALAMP STUDIO

rendering
S. TRAVERSO / ITALAMP STUDIO

Each item is equipped with its own documentation including a certificate of authenticity and a card with instructions for quality control inspections. In case of complaint the customer should send us a copy of this card, which also contains instructions for correct assembling of the fixture.

Italamp is not liable for incidental injuries or damage to people or things due to: incorrect installation of the fixtures, use of not suitable bulbs, modification of the original technical features of the items. The company has the right to modify any model for both aesthetic and technical features when necessary, according to Italtamp's unquestionable judgement.

The **CE** label is a European guaranteed mark.

It certifies product quality and its compliance with the safety standards stated by EEC regulations.

Italamp can provide for most of its products the UL certification.

Worldwide, UL tests products according to U.S. safety requirements for secure access anywhere in north U.S.

UNI EN ISO 9001/2015 steadily certifies the high quality and the great reliability of all Italtamp production processes.

Italamp is a registered trademark.

WARNING: The colors displayed, for known technical reasons, are indicative and may differ from the original: the reaction of colors, glass, textures, lacquers and metals varies depending on the thickness and overall size of the product but especially the light that beats on the overall surface. ITALAMP reserves the right to make any changes to the products it deems most appropriate, at any time and without notice.

All our items are registered and covered by patent.

This catalogue is copyrighted and protected by the italian law (22/4/1941 n°633 and 14/12/1942 n°1485).

Any reproduction of this catalogue is strictly forbidden.

**ITALAMP**

ITALAMP S.R.L.
All right reserved
via Fermi, 8
35010 CADONEGHE . PD . ITALY
t. +39 049 8870442
f. +39 049 8870418
info@italamp.com
italamp.com