

# LIGHT4

LIGHT & LIVING

Collezione  
**itama**  
BOOK 2019/06

A voyage  
between  
Italian art  
and design  
to discover  
the scenographic  
atmosphere  
of light  
and shadow.

**Itama**  
the Design  
of Light.

itama  
*by Light4*



	Status
VENICE	LANDED
VENICE	LANDED
NEW YORK	CONTACT
NEW YORK	CONTACT

*landing at the real heart  
of art, culture  
and Italian design*

Here we are in the place  
where lights and shadows  
interact with each other  
focusing on architectural beauty

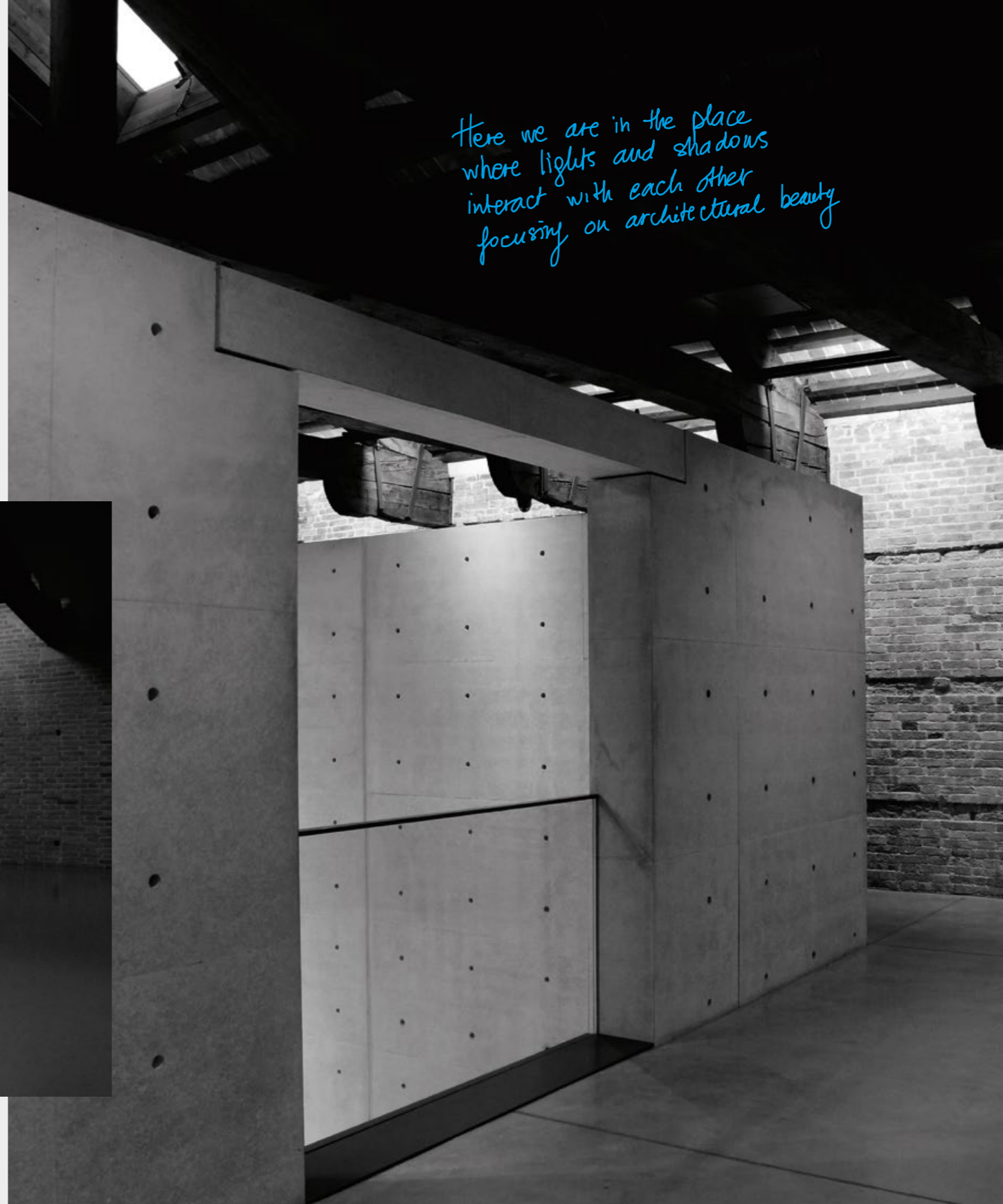

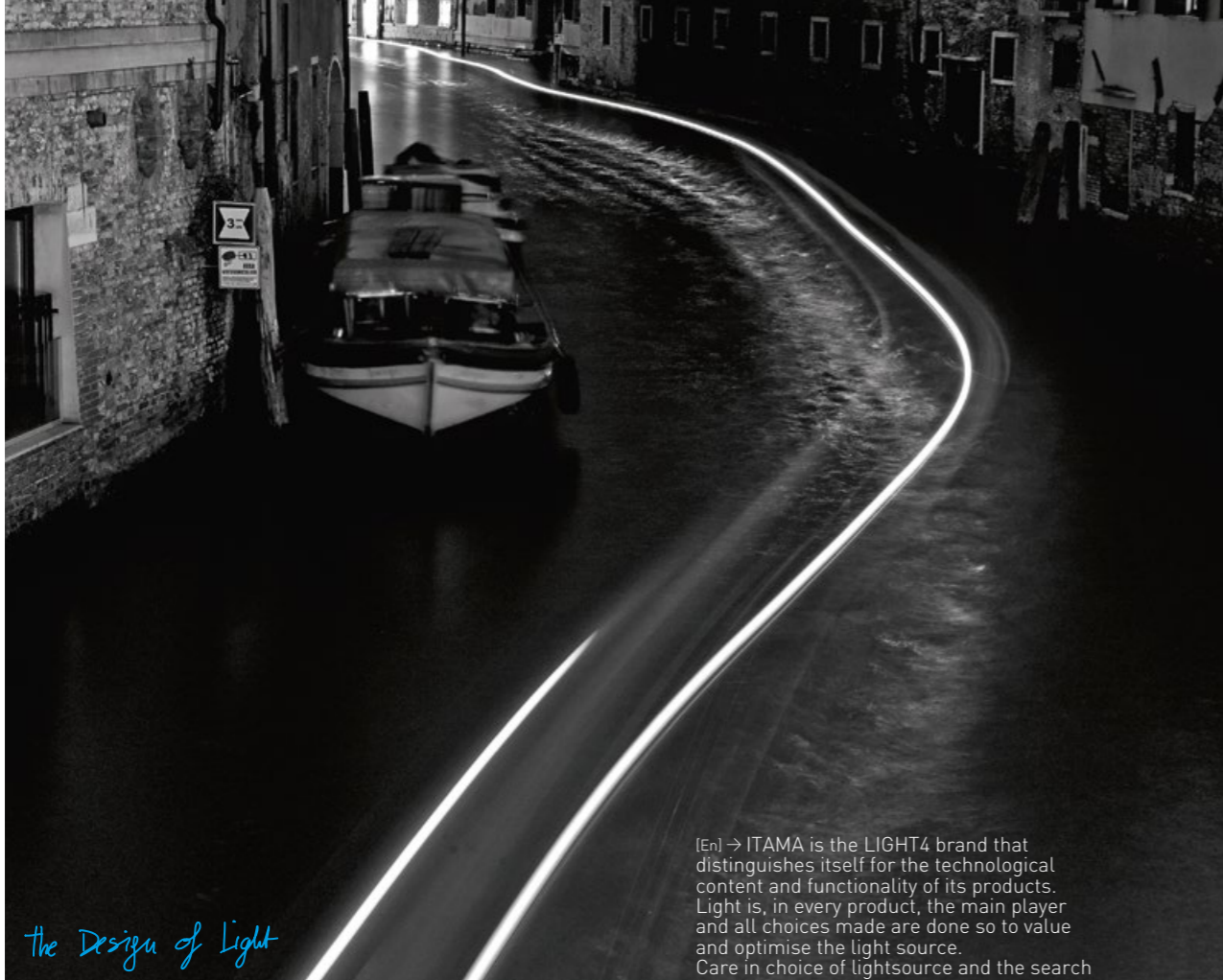

*The Design of Light*

[En] → ITAMA is the LIGHT4 brand that distinguishes itself for the technological content and functionality of its products. Light is, in every product, the main player and all choices made are done so to value and optimise the light source. Care in choice of lightsource and the search

for utmost quality of light emission goes hand in hand with the minimal design, attention to detail and finishes of all ITAMA collections. The technical evolution of light sources allows us new possibilities in lighting design, moving the traditional boundaries a little further away. All ITAMA products are 100% made in Italy.

[It] → ITAMA è il marchio LIGHT4 che si distingue per l'aspetto tecnologico e funzionale delle sue creazioni. La luce, in ogni prodotto è protagonista e le scelte formali sono concepite solo in funzione della valorizzazione e ottimizzazione della sorgente luminosa. L'attenzione e la ricerca per quanto riguarda la qualità della luce si sposa perfettamente con il design minimale e l'attenta cura dei dettagli e finiture delle collezioni ITAMA. L'evoluzione tecnica delle sorgenti luminose consente di esplorare nuove possibilità nel campo del lighting design mettendone in discussione i parametri tradizionali. Tutti i prodotti ITAMA sono al 100% made in Italy.



[De] → ITAMA ist eine der Marken von LIGHT4, die für das technologische und funktionelle Aussehen seines Schaffens steht. Das Licht ist der Star in jedem Produkt und die Formen sind nur in Bezug auf die Weiterentwicklung und Optimierung der Lichtquelle konzipiert. Die Aufmerksamkeit und Forschung in Bezug auf die Qualität des Lichtes passt in ITAMA perfekt zu dem minimalistischen Design mit der Liebe zum Detail und Ausführungen. Die technische Entwicklung der Lichtquellen verhilft neue Möglichkeiten im Bereich der Lichtgestaltung zu erforschen und führt zur Befragung der traditionellen Parameter. Alle Produkte von ITAMA sind 100% Made in Italy.

[Ru] → Itama от LIGHT4 это бренд, выделяющийся своей технологичностью и функциональностью. Свет – это главное в каждой модели, все остальное только подчеркивает источник света. Постоянный поиск новых решений, улучшающих качество света, идеально сочетается с минималистским дизайном и вниманием к деталям и отделкам. Техническая эволюция источников света позволяет добавлять новые возможности в области дизайна освещения, не опираясь на традиционные параметры. Вся продукция Itama на 100% сделана в Италии.

[Ar] → تصميم الإضاءة

ITAMA هي الماركة من LIGHT4 أن يميز نفسه عن محتوى التكنولوجيا و وظائف منتجاتها. الإضاءة في كل منتج وهو المثل الرئيسي وجميع الخيارات التي تحسن مصدر الضوء. الرعاية في اختيار مصدر الضوء والبحث عن الجودة القصوى ل انبعاث الضوء يسير متطابقة مع بساطة التصميم. تطور تقنية إنتاج مصادر الضوء يسمح لنا بتوفير إمكانيات جديدة في تصميم الإضاءة ، وتجاوز الحدود التقليدية قليلا. جميع المنتجات ITAMA 100% مصنوعة في إيطاليا.



# INDEX

## PREVIEW

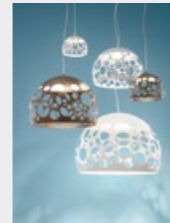

hole p. 12



aluled p. 22

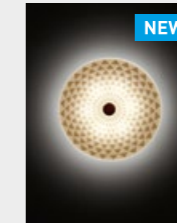

drop p. 84



jam p. 136

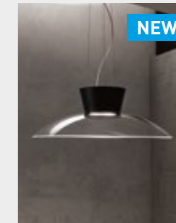

optik p. 186

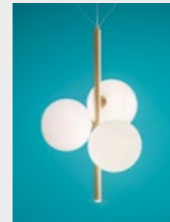

sat light p. 16

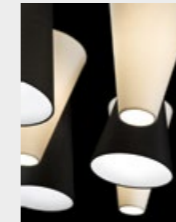

aqua p. 50

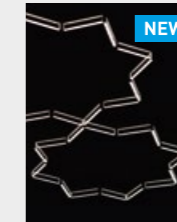

frame p. 94

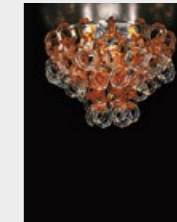

misstrass p. 150



ring p. 194



soft light p. 18

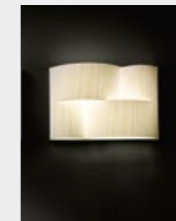

brick p. 66

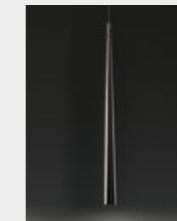

io p. 118

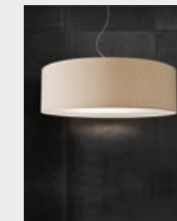

mlampshades p. 164

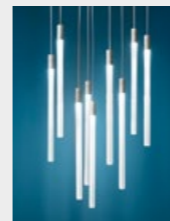

star light p. 20



candy p. 78

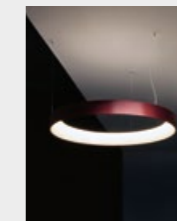

itashades p. 126



multi4 p. 178



**PREVIEW**

**HOLE  
SAT LIGHT  
SOFT LIGHT  
STAR LIGHT**



## HOLE

50 80  
suspension

dimensions  
Ø 80 x H 56 cm

color  
white

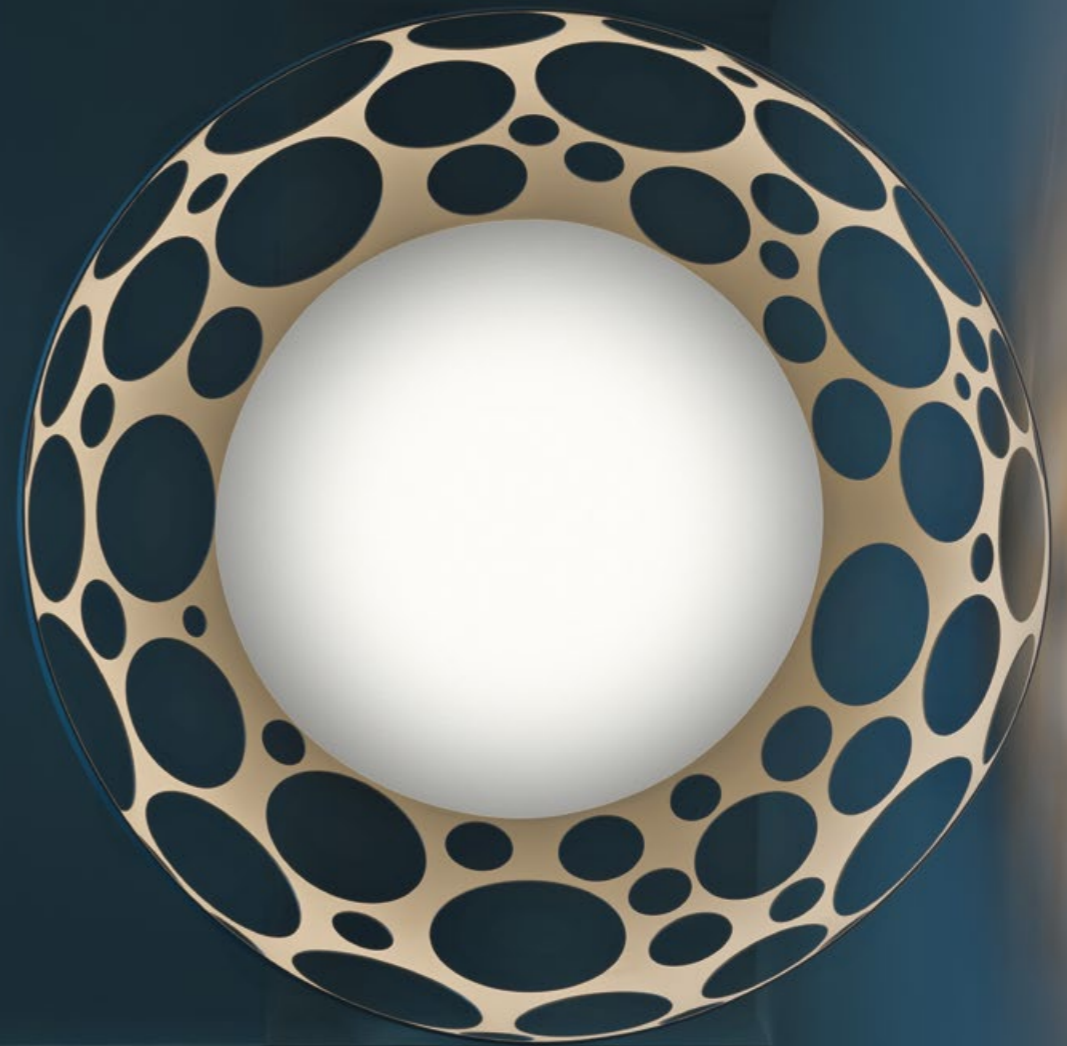



[En] → Aluminium dome in 5 different sizes decorated with laser cutted ornament. Structure in white and bronze painted finish. The LED light source is covered with a PMMA diffuser. White ceiling canopy.

[It] → Cupola in alluminio in 5 diverse misure, decoro ottenuto con tecnica del laser 3D. Finitura bianco e bronzo verniciato. Sorgente LED coperta da diffusore in PMMA. Rosone a soffitto bianco.

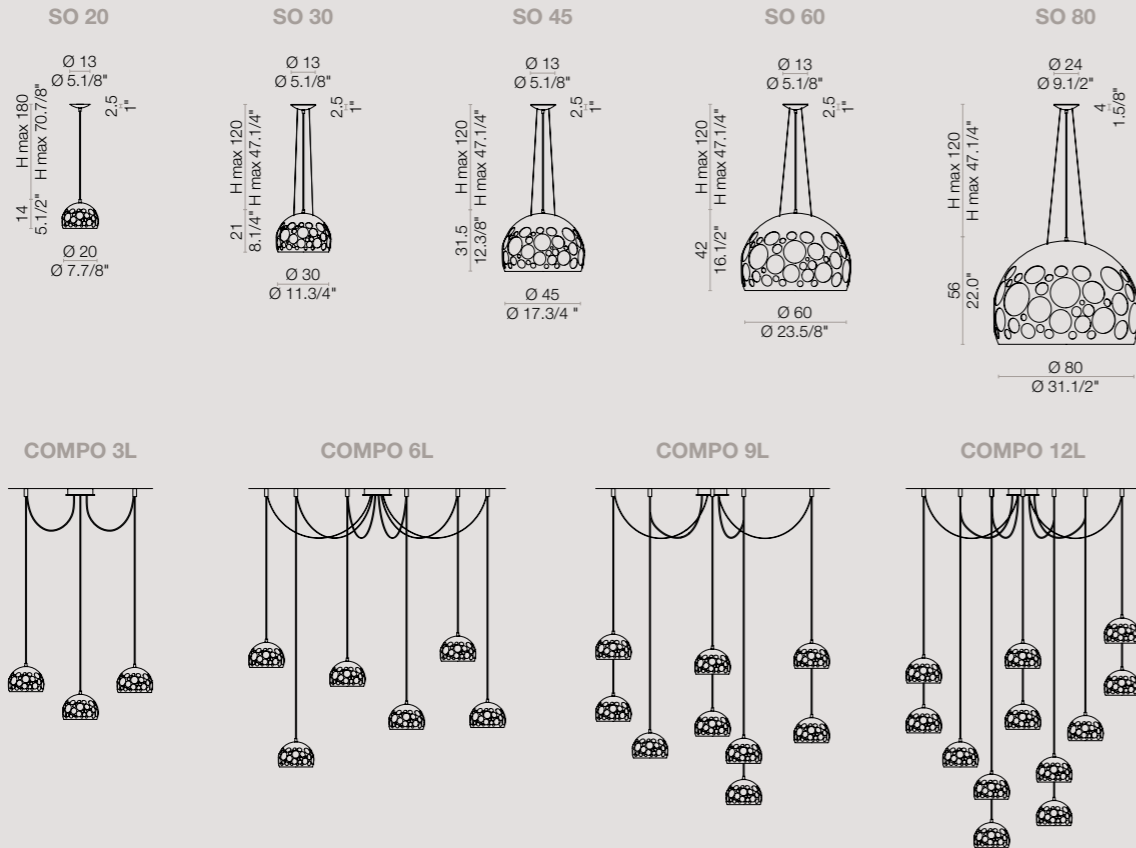

**colors**

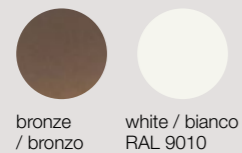

**material**

aluminium and PMMA  
 alluminio e PMMA

**light source**

- |  |   |
|--|---|
| <b>SO 20</b><br>1 x E14 230V SUITABLE FOR LED LAMPS    | <b>COMPO 3L</b><br>3 x E14 230V SUITABLE FOR LED LAMPS                                      |
| <b>SO 30 *</b><br>1 x GX53 230V SUITABLE FOR LED LAMPS | <b>COMPO 6L</b><br>6 x E14 230V SUITABLE FOR LED LAMPS                                      |
| <b>SO 45 *</b><br>3 x GX53 230V SUITABLE FOR LED LAMPS | <b>COMPO 9L</b><br>9 x E14 230V SUITABLE FOR LED LAMPS                                      |
| <b>SO 60 *</b><br>4 x GX53 230V SUITABLE FOR LED LAMPS | <b>COMPO 12L</b><br>12 x E14 230V SUITABLE FOR LED LAMPS                                    |
| <b>SO 80 *</b><br>5 x GX53 230V SUITABLE FOR LED LAMPS | * lightbulb NOT included / lampadina NON inclusa<br>GX53 LED 9,5W 230V 3000K 760lm LAGX539W |

**symbols**

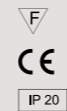

**energy label**

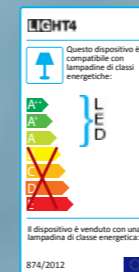

**SO 20 / SO 45 / SO 30**  
**SO 60 / SO 80**  
 suspensions

**dimensions**  
 Ø 20 x H 14 cm  
 Ø 45 x H 31,5 cm  
 Ø 30 x H 21 cm  
 Ø 60 x H 42 cm  
 Ø 80 x H 56 cm

**colors**  
 white  
 bronze

**SO**  
suspension

**dimensions**  
Ø 44 x H max 127 cm

**color**  
brushed gold



[En] → Suspension lamp with three frosted white blown glass spheres. Structure in brushed nickel and brushed gold. Each sphere contains a E14 light bulb creating a diffused light emission. Furthermore the vertical stem contains a LED downlight spot. Double light emission. Ceiling canopy: ceiling box white, cover disc in color.

[It] → Sospensione con tre sfere in vetro soffiato bianco acidato. Montatura in nichel spazzolato e oro spazzolato. Illuminazione diffusa con 3 lampadine E14 inserite nelle sfere e una sorgente LED diretta verso il basso inserita nell'asta centrale. Doppia accensione. Rosone: scatola a soffitto bianco, disco di copertura in tinta.

## SAT LIGHT collection

design Lorenzo Bertocco

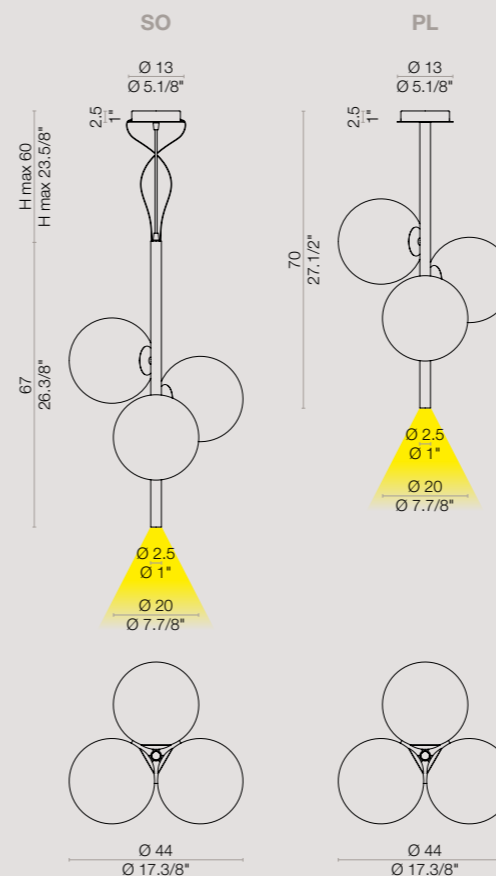

[En] → Ceiling lamp with three frosted white blown glass spheres. Structure in brushed nickel and brushed gold. Each sphere contains a G9 light bulb creating a diffused light emission. Furthermore the vertical stem contains a LED downlight spot. Double light emission. Ceiling canopy: ceiling box white, cover disc in color.

[It] → Plafoniera con tre sfere in vetro soffiato bianco acidato. Montatura in nichel spazzolato e oro spazzolato. Illuminazione diffusa con 3 lampadine G9 inserite nelle sfere e una sorgente LED diretta verso il basso inserita nell'asta centrale. Doppia accensione. Rosone: scatola a soffitto bianco, disco di copertura in tinta.

### colors

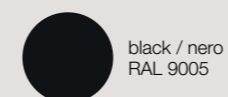
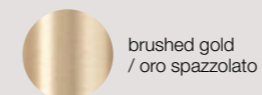
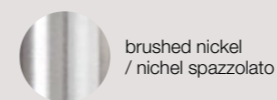

### material

metal and glass  
metallo e vetro

### light source

**SO / PL**  
3 x E14 230V SUITABLE FOR LED LAMPS  
+ 1 x LED 350mA 3.15W 3000K 410 lm

### symbols



### energy label

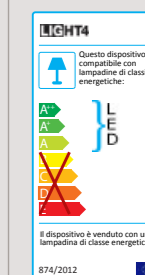

label A

**SOFT LIGHT** collection

design **Lorenzo Bertocco**

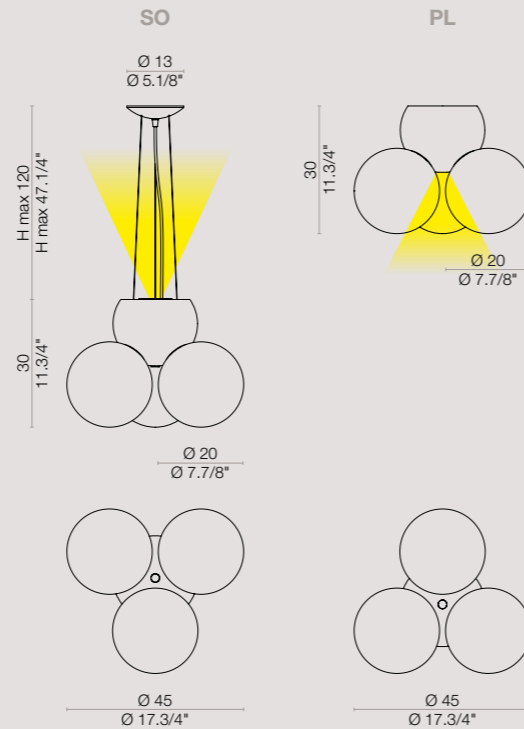

[En] → Ceiling lamp with three frosted white blown glass spheres. Structure in chrome and gold. Each sphere contains a E14 light bulb creating a diffused light emission. Furthermore the structure contains a LED downlight spot. Double light emission.

[It] → Plafoniera con tre sfere in vetro soffiato bianco acidato. Montatura in cromo lucido e oro lucido. Illuminazione diffusa con 3 lampadine E14 inserite nelle sfere e una sorgente LED diretta verso il basso inserita nella sfera centrale. Doppia accensione.

**colors**



polished chrome / cromo lucido



polished gold / oro lucido

**material**

metal and glass  
metallo e vetro

**light source**

**SO**

3 x E14 230V SUITABLE FOR LED LAMPS  
+ 1 x GX53 LED 9,5W 230V 3000K 760lm  
+ 1 x LED 350mA 3.15W 3000K 410lm

**PL**

3 x E14 230V SUITABLE FOR LED LAMPS  
+ 1 x LED 350mA 3.15W 3000K 410lm

**symbols**



**energy label**

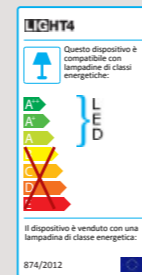

label **A**

**SO**

suspension

**dimensions**

Ø 45 x H max 120 cm

**color**

polished chrome



[En] → Suspension lamp with three frosted white blown glass spheres. Structure in chrome and gold. Each sphere contains a E14 light bulb creating a diffused light emission. Furthermore the central structure contains a LED downlight spot and a upwards LED lightsource. Double light emission. Ceiling canopy in color.

[It] → Sospensione con tre sfere in vetro soffiato bianco acidato. Montatura in cromo lucido e oro lucido. Illuminazione diffusa con 3 lampadine E14 inserite nelle sfere, una sorgente LED diretta verso il basso e una verso l'alto inserite nella sfera centrale in metallo. Doppia accensione. Rosone a soffitto in tinta.





**SO 9**

suspension

**dimensions**

Ø 60 x H max 175 cm

**color**

matt silver anodised



[En] → Suspension lamp composed by a borosilicate glass tube with a sandblasted PMMA tube in its interior. Structure in aluminium. Anodized finish in gold or natural. Double light emission. White ceiling canopy.

[It] → Sospensione in vetro borosilicato rigato con tubo PMMA sabbaiato al suo interno. Montatura in alluminio con finitura anodizzata naturale o finitura oro. Nelle sospensioni a 3 luci e 9 luci è inserita al centro una luce a LED 9,5W. Doppia accensione. Rosone a soffitto bianco.

**STAR LIGHT** collection

design Alessandro Lenarda

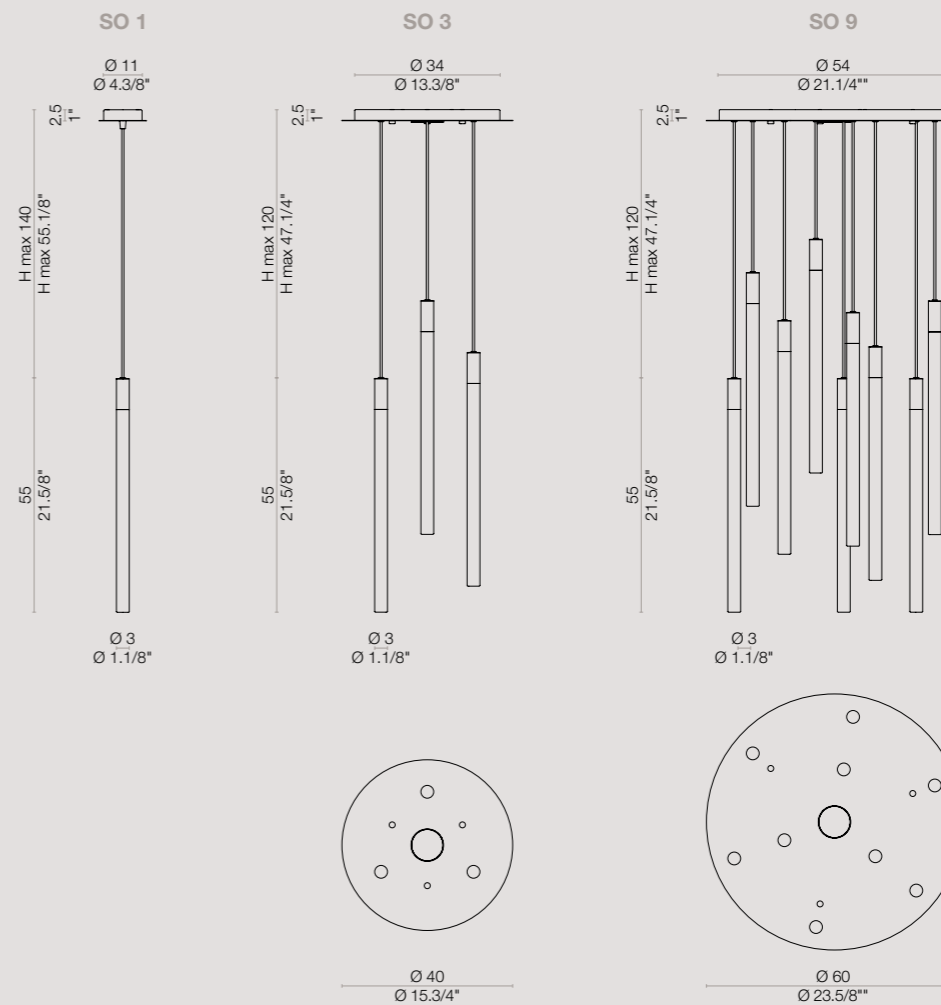

**colors**



**light source**

- SO 1**  
1 x LED 350mA 3.15W 3000K 410lm
- SO 3**  
3 x LED 350mA 3.15W 3000K 1230lm  
+ 1 x GX53 LED 9,5W 230V 3000K 760lm
- SO 9**  
9 x LED 350mA 3.15W 3000K 3690lm  
+ 1 x GX53 LED 9,5W 230V 3000K 760lm

**material**

metal, borosilicate glass and PMMA  
metallo, vetro borosilicato e PMMA

**symbols**



**energy label**

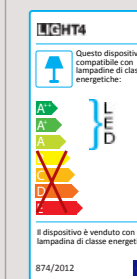

label A

A black and white photograph of a Venetian canal. In the foreground, several gondolas are moored along the water's edge, some covered with white tarps. The water is dark and reflects the light. In the background, multi-story buildings with arched windows and balconies line the canal. A bird is captured in mid-flight, its wings spread wide, flying across the upper center of the frame. The overall atmosphere is quiet and somewhat somber.

LET  
LIGHT  
LIVE  
ALULED

## ALULED collection

[En] → **Solid light.** The essentiality of ALULED becomes a shape that transforms itself into a container for the light-source. The functional character of the object, that allows users to interact with it, was fundamentally important for the choice of the shapes: ergonomically sound and minimal. The detailing and the color range make the object contemporary and easy to use in any kind of room set.

### **Solid light**

[It] → L'essenzialità in ALULED diventa forma traducendosi in contenitore della sorgente luminosa. Il carattere funzionale dell'oggetto, che consente all'utente di interagire con esso, è stato di fondamentale importanza per la scelta e lo studio della forma: ergonomica e minimale. I dettagli e la gamma cromatica contribuiscono a rendere l'oggetto contemporaneo e facilmente collocabile in ogni contesto.

### **Massives Licht**

[De] → Die Wesentlichkeit in ALULED wird Form und Behälter der Lichtquelle. Die funktionelle Natur des Objekts ermöglicht dem Benutzer, damit zu interagieren. Dieses Merkmal war auch von grundlegender Bedeutung für die Auswahl und die Untersuchung der Form: ergonomisch und minimal. Details und Farbpalette machen es zeitgemäß und einfach in jedem Kontext zu platzieren.

### **Осязаемый свет**

[Ru] → Модель ALULED предельно лаконична: источником и регулятором света служит весь корпус лампы, достаточно дотронуться до него рукой. Именно эта функциональная особенность и подсказала дизайнерам его эргономичную и минималистскую форму. Детали и цветовая гамма делают эту лампу современной и легко вписывающейся в любой интерьер.

### **الضوء الصلب**

[Ar] → انها تحول نفسها الى وعاء لمصدر للضوء ALULED الهامة وضرورة ان الطابع الوظيفي للجسم، والتي تتيج للمستخدمين التفاعل معها، وأهمية أساسية لاختيار الأشكال : سليم هندسيا والحد الأدنى. تفصيل ولون طائفة تجعل الكائن المعاصرة وسهلة الاستخدام في اي نوع من الغرف.

**AP 200**  
wall lamp

**dimensions**  
W 20 x DPT 5 x H 2.5 cm

**color**  
white 9010

**ALULED**  
→ **bar zero**

[En] → ALULED BAR ZERO is a simple volume that seems projected from the wall. Due to its light, it gives a material perception to the surface. The lighting fixture is available in two versions: one fixed on the longer side with minimal protrusion. The other version is fixed on the short side, thus increasing the protrusion.

[It] → ALULED BAR ZERO si presenta come un semplice volume estruso dalla parete, che dona, grazie alla sua luce, matericità alla superficie. La lampada è disponibile in due versioni: una fissata alla superficie sul lato lungo con sporgenza minima, e un'altra che, al contrario, viene montata sul lato corto, aumentando così la sporgenza.

**AP 165**  
wall lamp

**dimensions**  
W 20 x DPT 5 x H 2.5 cm

**color**  
concrete





concrete / cemento

white / bianco RAL 9010

black / nero RAL 9005

## ALULED bar zero collection

design L4B

AP 200

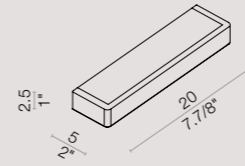

[En] → Lighting fixture in carved solid aluminium, powder-coated available in 2 colors and concrete finish. White PMMA diffuser. LED 220-240V. Not-adjustable version as wall lamp. Frame in powder-coated aluminium, available in 2 colors.

[It] → Corpo illuminante in alluminio ricavato dal pieno verniciato a polveri nei 2 colori disponibili e finitura cemento. Diffusore in PMMA bianco. Sorgente LED 220-240V. Versione fissa solo parete. Montatura in alluminio verniciato a polveri nei 2 colori disponibili.

### material

aluminium  
alluminio

### light source

LED 220-240V  
120V for  
NORTH AMERICA

Dimmer not included  
Dimmer non incluso

### equipment

**AP 200**  
13.5W LED 3000°K lm1450

### symbols

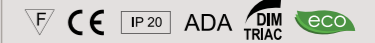

### photometric test BAR

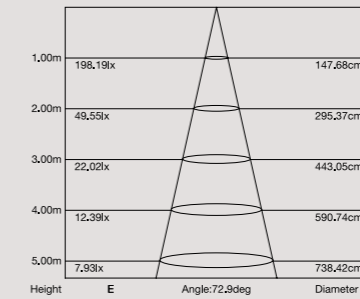
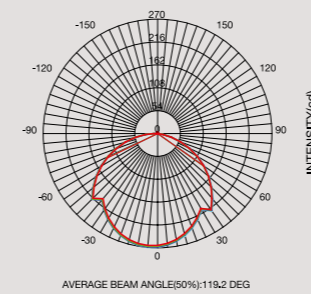

### energy label

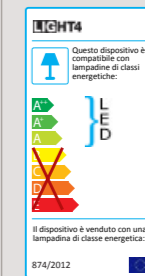

label A







[En] → The junction version of ALULED BAR has a 359 degrees rotation, directing the light at wish.

[It] → La versione snodabile di ALULED BAR permette la rotazione di 359 gradi del corpo illuminante, direzionando in questo modo la luce.



### **ALULED bar**

**AP 1L**  
wall lamp

**dimensions**  
W 23 x DPT 12.5 cm

**color**  
white 9010

## **ALULED bar**

**AP 1L**  
wall lamp

**dimensions**  
W 23 x DPT 12.5 cm

**color**  
black 9005

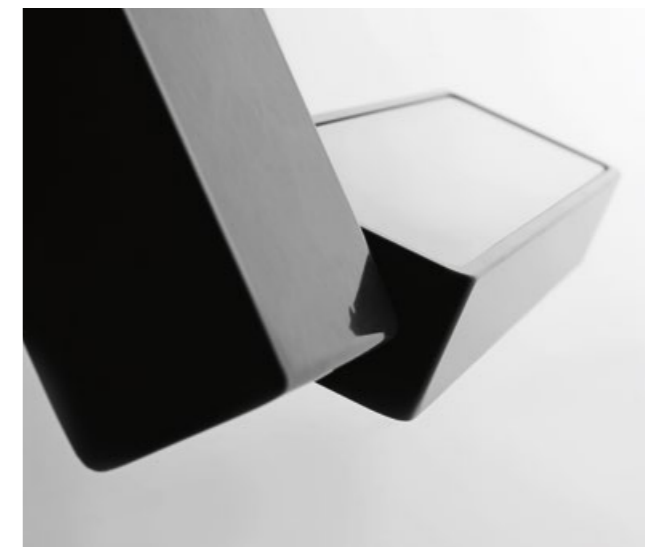

[En] → Both the junction and lighting element of ALULED BAR can be fitted in different ways: structure and single lighting fixture, or structure and double lighting fixture. It is possible to change the finishes of these parts, obtaining in this way several combinations.

[It] → Snodo ed elemento luminoso di ALULED BAR possono essere composti in diversi modi: montatura e corpo illuminante singolo oppure montatura e corpo illuminante doppio. Inoltre è possibile variare le finiture di queste parti ottenendo molteplici combinazioni.

[En] → Lighting fixture in carved solid aluminium, powder-coated available in 2 colors and concrete finish. White PMMA diffuser. LED 220-240V. 359° adjustable version as wall/ceiling lamp. Frame in powder-coated aluminium, available in 2 colors. Chromed metal joint.

[It] → Corpo illuminante in alluminio ricavato dal pieno verniciato a polveri nei 2 colori disponibili e finitura cemento. Diffusore in PMMA bianco. Sorgente LED 220-240V. Versione orientabile 359° parete e plafoniera. Montatura in alluminio verniciato a polveri nei 2 colori disponibili. Snodo metallo cromato.

colors



white / bianco  
RAL 9010



black / nero  
RAL 9005



concrete / cemento

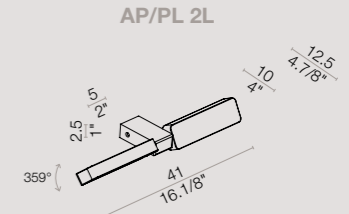
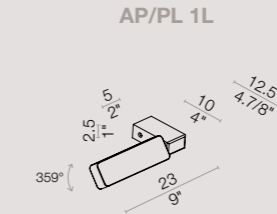
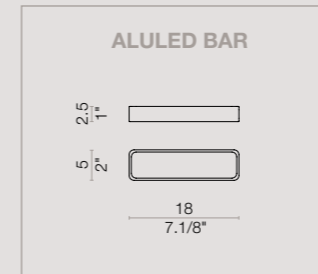

material

aluminium  
alluminio

light source

LED 220-240V

120V for  
NORTH AMERICA

Dimmer not included  
Dimmer non incluso

equipment

**AP/PL 1L**  
13.5W LED 3000°K lm1450

**AP/PL 2L**  
27W LED 3000°K lm2900

symbols



photometric test BAR

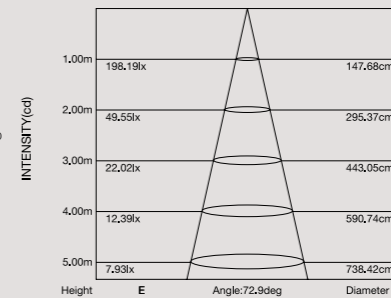
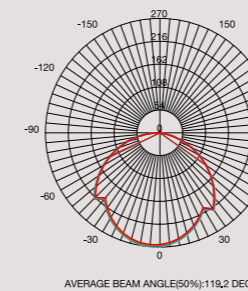

energy label

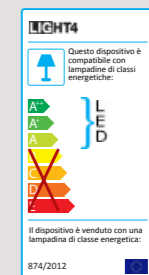

label A



**ALULED**  
→ **disc**

[En] → ALULED DISC is defined by the circular shape of the lighting fixture. The LED lighting source fits in a block of a carved solid aluminium which is a feature of this lamp and it is also at the same time a heat sink.

[It] → ALULED DISC, si caratterizza per la forma circolare del corpo illuminante. La sorgente luminosa LED, alloggia in un volume di alluminio pieno che dà spessore, peso e importanza alla lampada e fa sì che quest'ultima, funga anche da dissipatore di calore.



## ALULED disc

AP 1L  
wall lamp

dimensions  
W 18 x DPT 15.5 cm

colors  
white 9010 + black 9005

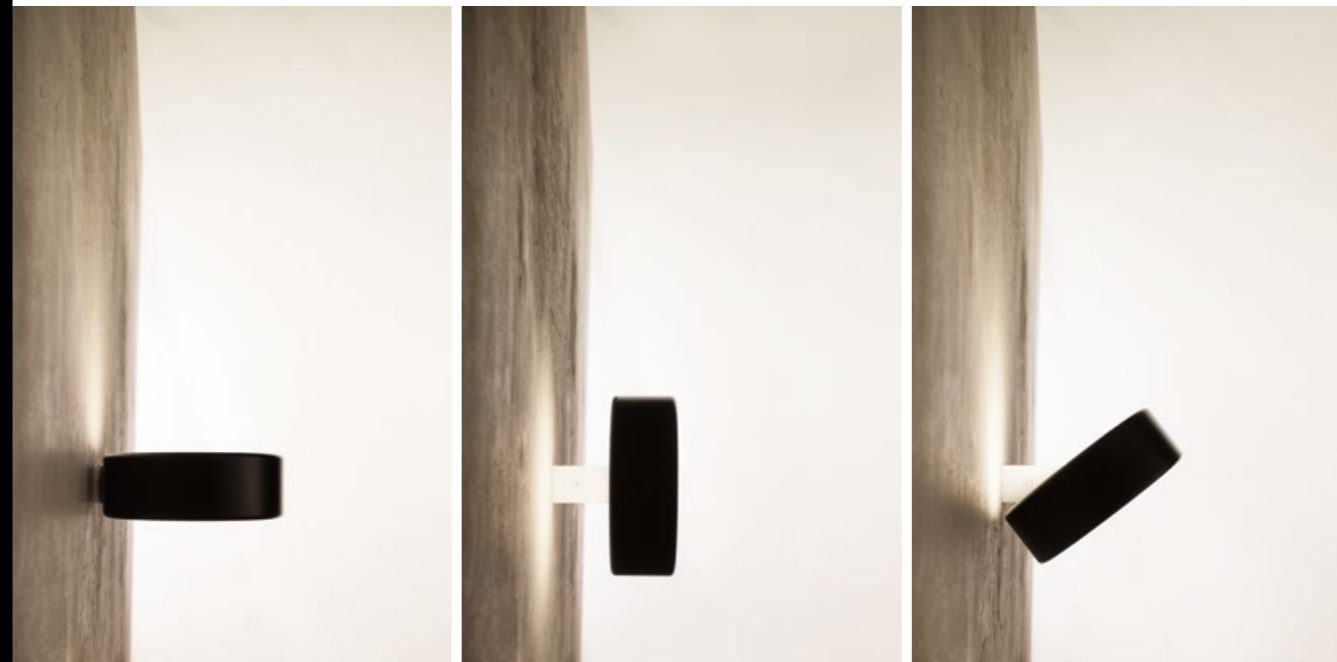

[En] → The aluminium support and chrome plated metal joint allow the lighting fixture 359° rotation. The length of the frame has been calculated in order to minimize the projection of this lighting fixture.

[It] → Il supporto in alluminio e lo snodo in metallo cromato, permettono al corpo illuminante di ruotare di 359 gradi. La lunghezza della montatura è stata calcolata in modo tale da ridurre al massimo la sporgenza della lampada.

[En] → Lighting fixture in carved solid aluminium, powder-coated available in 2 colors and concrete finish. White PMMA diffuser. LED 220-240V. 359° adjustable version as wall/ceiling lamp. Frame in powder-coated aluminium, available in 2 colors. Chromed metal joint.

[It] → Corpo illuminante in alluminio ricavato dal pieno verniciato a polveri nei 2 colori disponibili e finitura cemento. Diffusore in PMMA bianco. Sorgente LED 220-240V. Versione orientabile 359° parete e plafoniera. Montatura in alluminio verniciato a polveri nei 2 colori disponibili. Snodo metallo cromato.

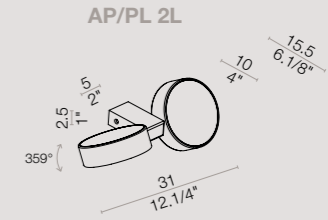
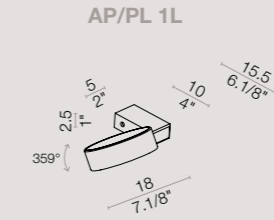

material

aluminium  
alluminio

light source

LED 220-240V  
120V for  
NORTH AMERICA  
Dimmer not included  
Dimmer non incluso

equipment

**AP/PL 1L**  
10W LED 3000°K 1500 lm  
**AP/PL 2L**  
20W LED 3000°K 3000 lm

symbols

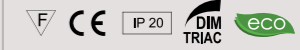

photometric test DISC

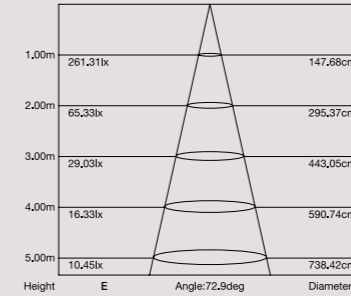
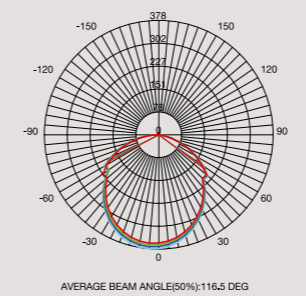

energy label

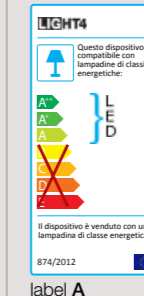

colors



**AP 1L**  
wall lamp

**dimensions**

W 17 x DPT 15 cm

**colors**

white 9010 + black 9005

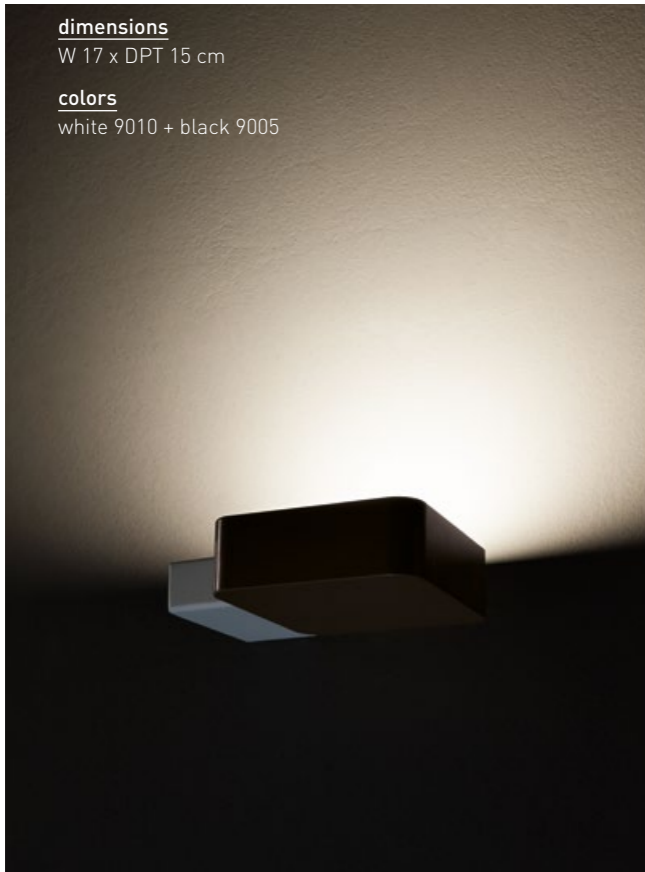

**ALULED**  
→ **square**

[En] → ALULED SQUARE is composed of a square element, a pure and regular shape softened by rounded edges. The lighting fixture is assembled in a single or double version with a powder coated aluminium support allowing installation of the fixture either on ceilings or on walls.

[It] → ALULED SQUARE, si compone di un elemento quadrato dalla forma pura e regolare ingentilita dall'arrotondamento degli spigoli. Il corpo illuminante è applicato, in versione singola o doppia a un supporto in alluminio verniciato a polveri consentendo l'utilizzo della lampada sia a soffitto che a parete.

**AP 1L**  
wall lamp

**dimensions**

W 17 x DPT 15 cm

**colors**

white 9010 + black 9005





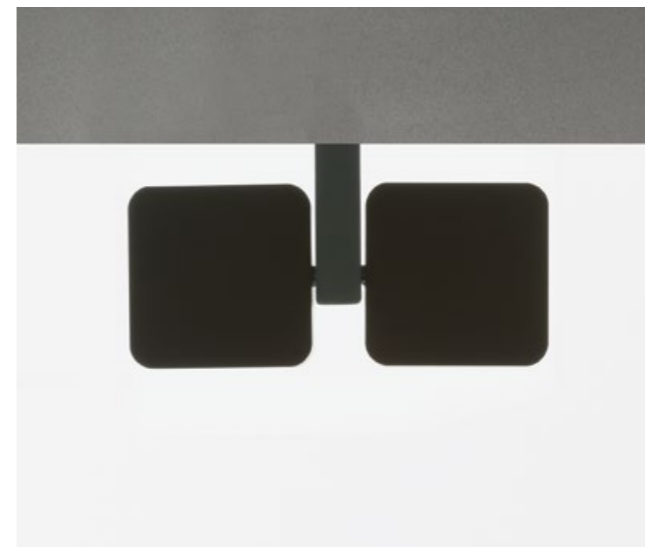
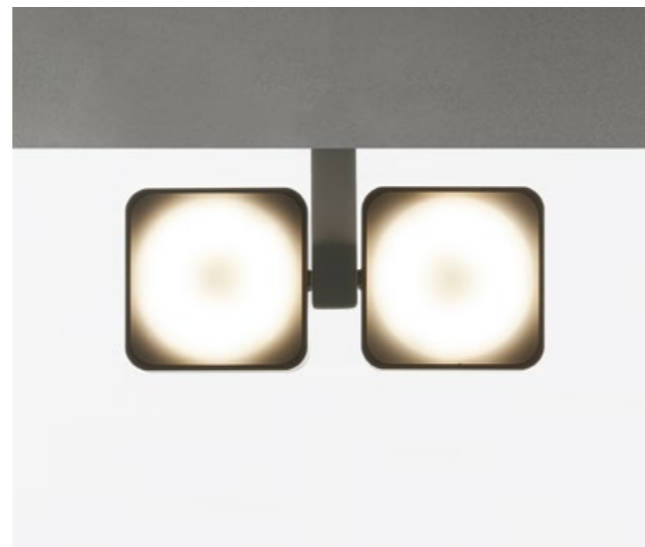
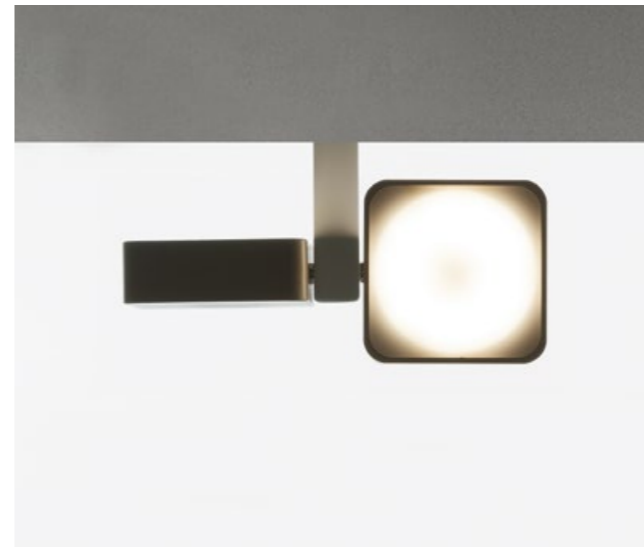
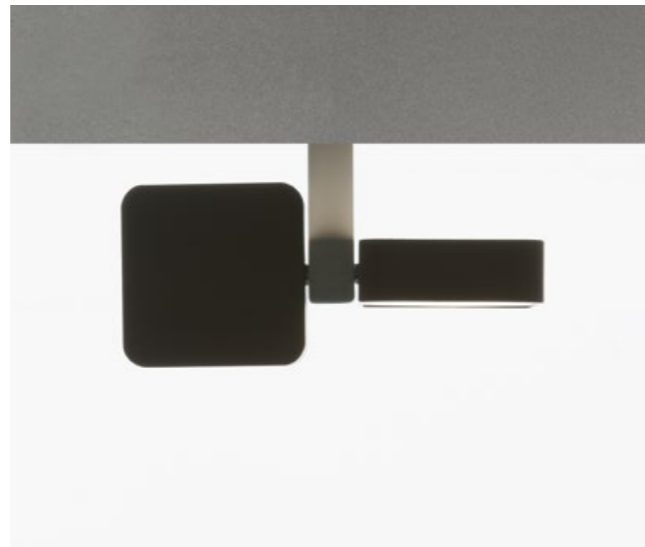

[En] → The chrome plated joints of ALULED SQUARE allow a 359° independent rotation of the lighting fixtures. The fixtures are assembled with a powder coated aluminium support available in three different lengths.

[It] → Gli snodi cromati di ALULED SQUARE, consentono la rotazione indipendente di 359 gradi dei corpi illuminanti. Questi ultimi, sono applicati ad un supporto in alluminio verniciato a polveri disponibile in tre lunghezze.

## ALULED square

**PL 30 1L**  
ceiling lamp

**dimensions**  
L 14.5 x H max 35 cm

**colors**  
white 9010 + black 9005

[En] → The precision given by CNC machining, which is used to manufacture both the lighting fixture made from carved solid aluminium and the PMMA diffuser, allow the fixing system of the two parts with no visible mechanical elements.

[It] → La precisione data dalle lavorazioni a controllo numerico, con cui vengono prodotti sia il corpo illuminante ricavato da un pieno in alluminio, sia il diffusore in PMMA, permettono un fissaggio delle due parti, privo di elementi meccanici a vista.



## ALULED square collection

design L4B

[En] → Lighting fixture in carved solid aluminium, powder-coated available in 2 colors and concrete finish. White PMMA diffuser. LED 220-240V. 359° adjustable version as wall/ceiling lamp. Frame in powder-coated aluminium, available in 2 colors. Chromed metal joint.

[It] → Corpo illuminante in alluminio ricavato dal pieno verniciato a polveri nei 2 colori disponibili e finitura cemento. Diffusore in PMMA bianco. Sorgente LED 220-240V. Versione orientabile 359° parete e plafoniera. Montatura in alluminio verniciato a polveri nei 2 colori disponibili. Snodo metallo cromato.

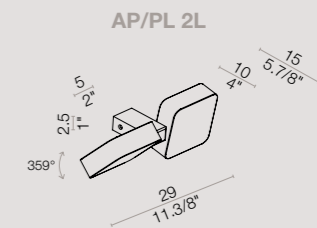
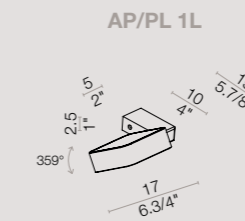
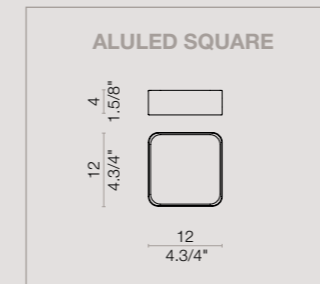

### material

aluminium  
alluminio

### light source

LED 220-240V  
120V for  
NORTH AMERICA  
Dimmer not included  
Dimmer non incluso

### equipment

**AP/PL 1L**  
10W LED 3000°K 1500 lm  
**AP/PL 2L**  
20W LED 3000°K 3000 lm

### symbols



### photometric test SQUARE

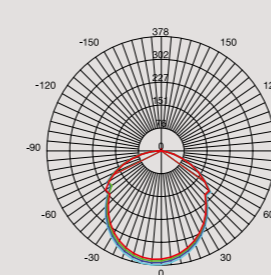

Height	E	Angle: 72,9deg	Diameter
1,00m	261,31lx		147,68cm
2,00m	65,33lx		295,37cm
3,00m	29,03lx		443,05cm
4,00m	16,33lx		590,74cm
5,00m	10,45lx		738,42cm

### energy label

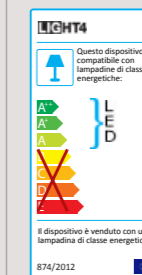

label A

### colors



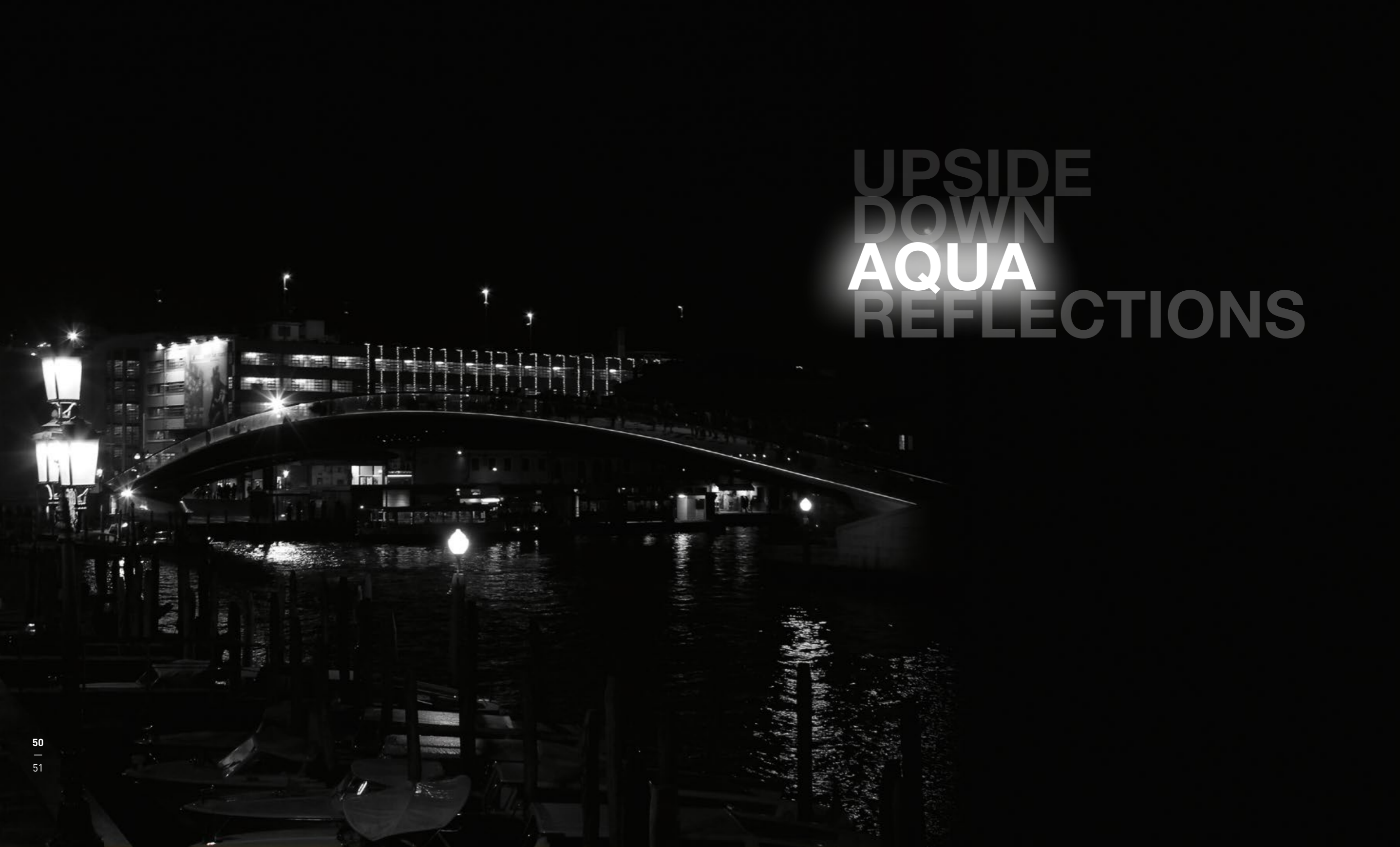

UPSIDE  
DOWN  
**AQUA**  
REFLECTIONS

## **AQUA** collection

[En] → The colour, the light and the fabric: AQUA is a system of modular suspensions where symmetrically tapered truncated cone diffusers alternate. AQUA offers great versatility also in composing multiple modular solutions. The suspensions can be arranged in a rectangular or square base, around a circumference or on a single straight line. AQUA is a hymn to the imagination, it makes composers and protagonists of the space.



[It] → Il colore, la luce e il tessuto: AQUA è un sistema di sospensioni modulari dove si alternano diffusori a tronco di cono ribaltati simmetricamente. AQUA offre una grande versatilità anche nel comporre molteplici soluzioni modulari. Le sospensioni possono essere disposte a matrice, su base rettangolare o quadrata, attorno a una circonferenza oppure su un'unica linea retta. AQUA è un inno alla fantasia, rende compositori e protagonisti dello spazio.



### **AQUA**

**SO L**  
suspension

**colors**  
light blue 13  
blue 12  
white 01



**AQUA**

**SO 1L UP**  
suspension

**dimensions**  
Ø 22 x H 37.5 cm

**color**  
white 01







58

59



Custom composition 15L



Hotel Suomu / Finland



Asilo Nido di Bascapè / Pavia (IT)



Sjuxr Paros Restaurant / Puerto Rico



Terrazza Drago / Jesolo Lido (IT)



Crowne Plaza / Saint Petersburg (RU)



[En] → Lampshades in PVC completed with cotton fabric available in 8 colours. Structure in white painted metal.

[It] → Paralumi in PVC traslucido accoppiato con tessuto di cotone negli otto colori disponibili. Montatura in metallo verniciato bianco.

SO 1L DOWN



SO 1L UP



SO 3L

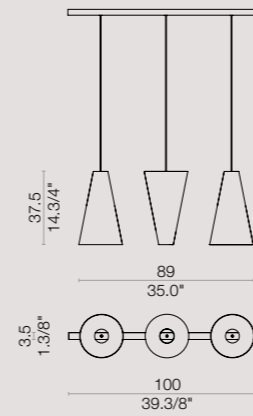

COMPO 6L

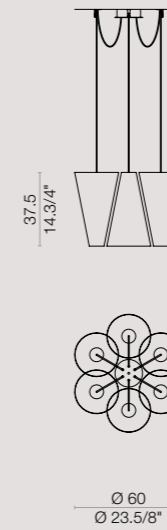

COMPO 12L

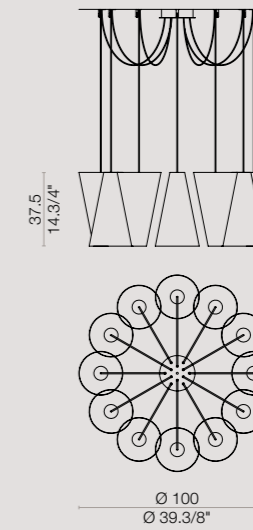

material

fabric + metal  
tessuto + metallo

colors



COMPO 3L

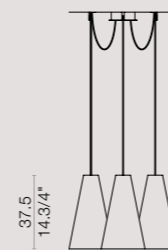

COMPO 6L

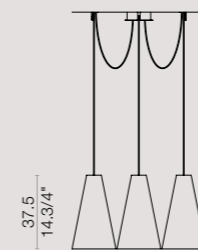

COMPO 9L

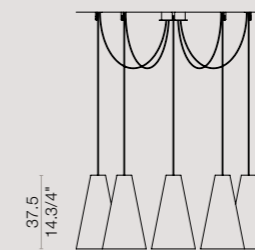

COMPO 12L

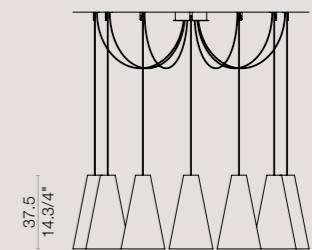

light source

SO 1L DOWN

1 x E27 SUITABLE FOR LED LAMPS

SO 1L UP

1 x E27 SUITABLE FOR LED LAMPS

SO 3L

3 x E27 SUITABLE FOR LED LAMPS

COMPO 6L

6 x E27 SUITABLE FOR LED LAMPS

COMPO 12L

12 x E27 SUITABLE FOR LED LAMPS

COMPO 3L

3 x E27 SUITABLE FOR LED LAMPS

COMPO 6L

6 x E27 SUITABLE FOR LED LAMPS

COMPO 9L

9 x E27 SUITABLE FOR LED LAMPS

COMPO 12L

12 x E27 SUITABLE FOR LED LAMPS

symbols



energy label

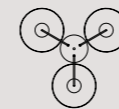
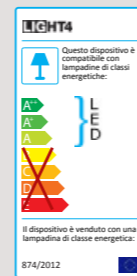

Ø 60  
Ø 23.5/8"

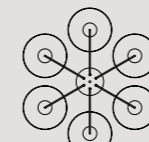

Ø 75  
Ø 29.1/2"

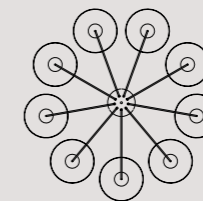

Ø 100  
Ø 39.3/8"

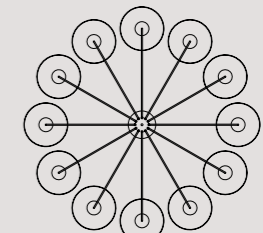

Ø 120  
Ø 47.1/4"

A black and white photograph of a bridge with silhouetted figures and a street lamp against a cloudy sky. The scene is captured in silhouette, with the bridge's structure and the figures of people walking across it appearing as dark shapes against a lighter, overcast sky. A street lamp is visible in the upper left corner. The overall mood is somber and contemplative.

ANOTHER  
BRICK  
IN THE WALL



**COMPO 2 AP/PL 75**  
wall lamp

**dimensions**  
L 150 x W 13.5 x H 30 cm

**colors**  
white 01  
cream 10  
tobacco 09

## **BRICK** collection

[En] → **A wall of light.** The BRICK collection allows you to create an infinite number of compositions through a simple and flexible modular system. The two sizes of decorative fabric elements are fixed on the diffusers through a joint system. The various types of frames can be composed together to create original shapes.

### **Un muro di luce**

[It] → La collezione BRICK permette di creare un'infinità di composizioni attraverso un sistema modulare semplice e flessibile. Le due misure di elementi decorativi in tessuto si fissano sui diffusori attraverso un sistema di incastro. I vari tipi di montatura possono essere composti tra loro in modo da creare forme originali.





**BRICK**

**AP/PL 45**  
wall lamp

**dimensions**  
L 45 x W 13.5 x H 30 cm

**color**  
cream 07



**BRICK**

**COMPO 4 AP/PL 75**  
wall lamp

**dimensions**  
L 150 x W 13.5 x H 60 cm

**colors**  
white 01  
cream 10  
tobacco 09



Custom composition



Resort "Il Gabbiano" / Tropea (IT)



Residenza privata / Rovigo (IT)

[En] → Structure in white painted metal  
Diffuser in white PMMA.  
Decorative elements in PVC completed  
with cotton fabric available in 4 colours.

[It] → Montatura in metallo verniciato bianco.  
Diffusore in metacrilato bianco.  
Elementi decorativi in pvc traslucido accoppiato  
con tessuto di cotone nei quattro colori disponibili.

AP/PL 45

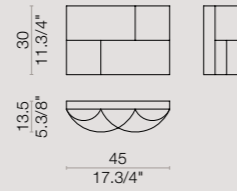

AP/PL 75

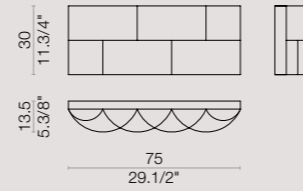

COMPO 2 AP/PL 75

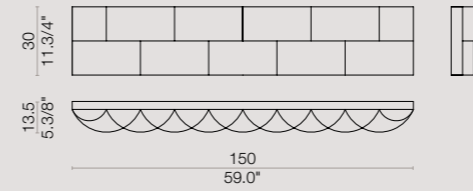

COMPO 4 AP/PL 75

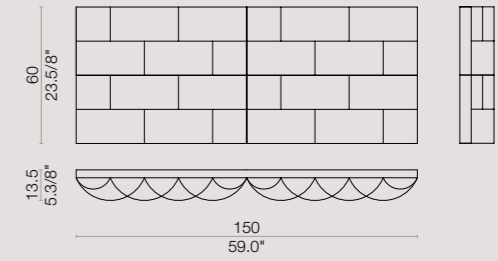

AP/PL 150

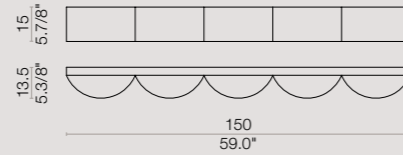

COMPO MAXI

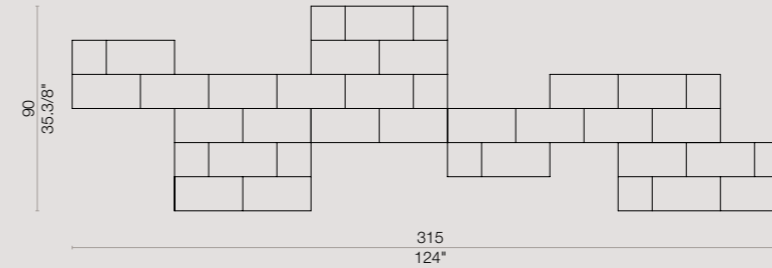

AP/PL SQ 60

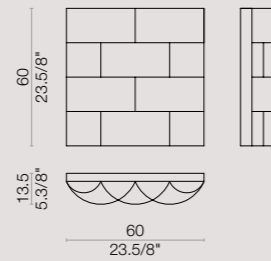

COMPO 2 AP/PL SQ 60

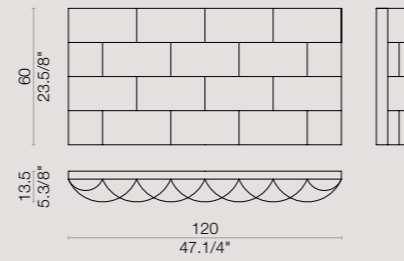

colors



material

fabric + metal  
+ methacrylate  
tessuto + metallo  
+ metacrilato

symbols



light source

**AP/PL 45**  
14W LED 3000K 2145 lm  
**AP/PL 75**  
25W LED 3000K 3400 lm  
**AP/PL 150**  
25W LED 3000K 3400 lm  
**AP/PL SQ 60**  
26W LED 3000K 4000 lm

**COMPO 2 AP/PL SQ 60**  
52W LED 3000K 8000 lm  
**COMPO 2 AP/PL 75**  
50W LED 3000K 6800 lm  
**COMPO 4 AP/PL 75**  
100W LED 3000K 13600 lm

energy label



label A







SWEET  
LIKE A  
**CANDY**  
GLASS

[En] → CANDY creates a sophisticated and elegant light: the diffuser and the blown glass base emit a warm and uniform light thanks to the satin finish. CANDY is available as table lamp in three sizes.

[It] → CANDY propaga una luce sobria ed elegante: il diffusore e la base in vetro soffiato emettono una luce calda ed uniforme grazie alla finitura satinata. CANDY è disponibile nella versione da tavolo in tre misure.

**TA 35 / TA 75 / TA 55**

table lamps

**dimensions**

Ø 22 x H 35 cm

Ø 44 x H 75 cm

Ø 36 x H 55 cm

Base



Shade



Base + Shade



[En] → The feature of the collection is the double light emission. The light source, in fact, is contained both in the base of the lamp as in the lampshade. This allows you to customize completely the light of the lamp.

[It] → La caratteristica della collezione è la doppia accensione. La sorgente luminosa, infatti, è contenuta sia nella base della lampada che nel paralume. Ciò dà all'utente la possibilità di personalizzare l'emissione luminosa, adattandola alle proprie esigenze.

**CANDY** collection

design Archivio Storico

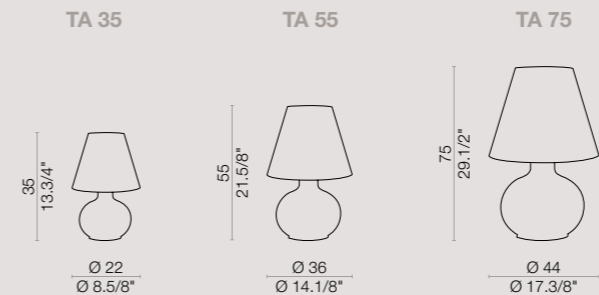

[En] → Blown glass cased white satin-finish. Structure in matt white painted metal.

[It] → Vetro soffiato incamiciato bianco satinato montatura in metallo verniciato bianco opaco.

**All version: double switch**  
**Tutte le versioni: doppia accensione**

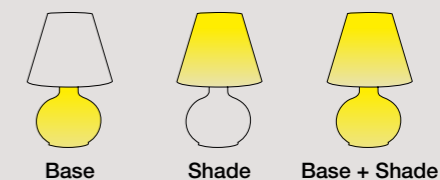

**material**

glass + metal  
vetro + metallo

**light source**

- TA 35**  
1 x E14 SUITABLE FOR LED LAMPS  
+ 1 x E14 SUITABLE FOR LED LAMPS
- TA 55**  
1 x E27 SUITABLE FOR LED LAMPS  
+ 2 x E14 SUITABLE FOR LED LAMPS
- TA 75**  
1 x E27 SUITABLE FOR LED LAMPS  
+ 2 x E14 SUITABLE FOR LED LAMPS

**symbols**



**energy label**

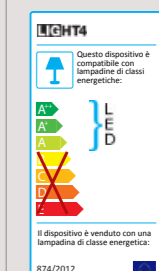

label A



LIGHT  
DROP  
BIG  
RIPPLE

## **DROP**

**AP/PL 60**

wall or ceiling lamp

**dimensions**

Ø 62.5 x DPT 10 cm



[En] → The DROP collection is embellished through a renewed decoration. The new design is inspired by the beauty of geometric decoration, typical of the Arab world. The effect is that of a fascinating vortex of light and shadows.

[It] → La collezione DROP viene impreziosita attraverso una rinnovata decorazione. Il nuovo disegno trae ispirazione dalla bellezza del decoro geometrico, tipico del mondo arabo. L'effetto è quello di un affascinante vortice di luce ed ombre.





## **DROP** collection

[En] → **A drop in the sea.** Like a stone thrown into water stirs waves and reverberation, light transforms and brings DROP to life. The glass diffuser, decorated by several layers of serigraphy, gives the product a decoration that can only be seen when the lamp is illuminated. The diffuser is also wrapped in a structural prismatic PMMA element that spreads the light in a uniform manner all around.



### **Una goccia nel mare**

[It] → Come il sasso lanciato in uno specchio d'acqua la anima di onde e riverberi, così la luce trasforma e dà vita a DROP. Il diffusore in vetro, decorato da diversi strati serigrafati, conferisce all'oggetto una decorazione luminosa visibile solamente accendendo la lampada. Quest'ultimo è avvolto da un elemento strutturale in PMMA prismatico che diffonde la luce in modo omogeneo nell'ambiente.

### **Ein Tropfen im Meer**

[De] → Ein Stein ins Wasser geworfen, lebt mit Wellen und konzentrischen Kreisen, so wie das Licht. Der Glasdiffusor, mit mehreren siebgedruckten Schichten dekoriert, gibt dem Objekt ein helles Erscheinen, das nur durch die Beleuchtung der Lampe sichtbar wird.

### **Морские капли**

[Ru] → Как камешек, брошенный на зеркальную поверхность воды, оставляет за собой круги, так и свет дает жизнь и трансформируется в модели DROP. Стеклоный рассеиватель с несколькими наложенными слоями трафаретной печати придает лампе при ее включении декоративный светящийся характер. Структурный элемент, сделанный в полиметилметакрилате, равномерно рассеивает свет в пространстве.

### **دروب قطرة في بحر**

[Ar] → تحفة تتألق و ذلك نتيجة استخدام عنصر PMMA في تغليف الناشر مما يؤدي لانتشار الضوء بشكل موحد في كل مكان ، تجذب اهتمام الناظر عندما يضاء المصباح حيث تعطى زخرفة جميلة مثل حجر القلي في الماء فيثير التموجات والصدى.



## **DROP**

**AP/PL 45**  
wall or ceiling lamp

**dimensions**  
Ø 48 x DPT 10 cm



Floral decoration

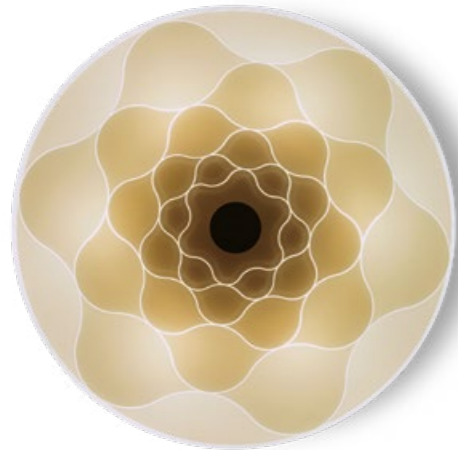

ON



OFF

Oriental decoration



ON



OFF

[En] → When the lighting fixtures is off, the surface of the silkscreened glass diffuser looks like an even white surface, and you can see only the outlines of the decoration. When on, the surface is alive with different color shades, due to the number of silkscreen layers. Along the outline of the decoration, the light is clearer because there is less color; instead towards the center, where there is more color, the intensity of light decreases.

[It] → La superficie serigrafata del diffusore in vetro piano, quando la lampada è spenta, si presenta come una superficie omogenea bianca in cui si notano solo i contorni dei decori. Con la luce, la superficie si anima di diverse tonalità determinate dalla quantità di strati di serigrafia. Lungo il perimetro, la luce è più chiara poichè minore è l'apporto di colore, mentre verso il centro, dove questo è maggiore, diminuisce l'intensità luminosa.

**DROP** collection

design Brian Rasmussen

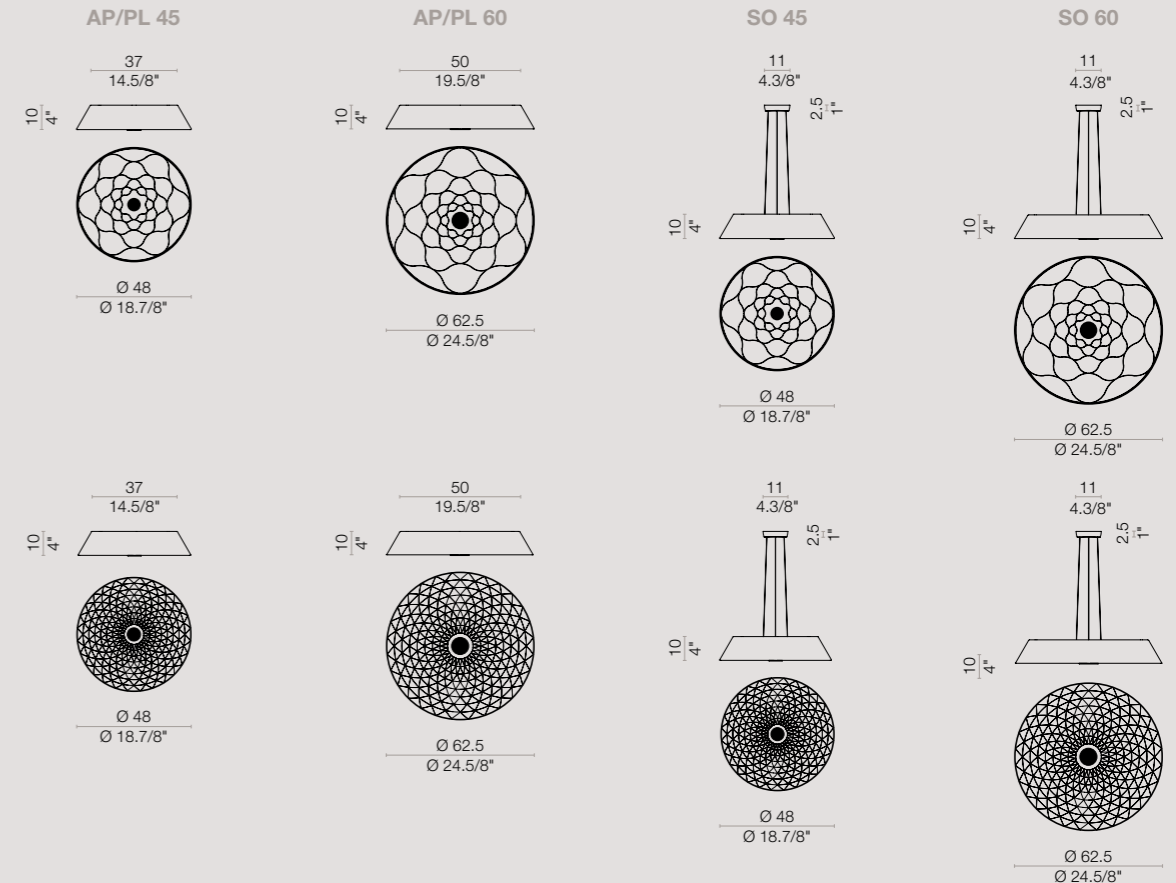

[En] → Flat panel glass front diffuser, with multi-layer silkscreened décor. Prismatic thermoformed PMMA side diffuser, detail in carved solid aluminium, chrome or polished gold. LED 220-240V.

[It] → Diffusore frontale in vetro piano con decoro serigrafato multistrato. Diffusore laterale in PMMA prismatico termoformato, particolare in alluminio ricavato dal pieno, cromato o dorato. Sorgente LED 220-240V.

material

glass and PMMA  
vetro e PMMA

light source

LED 220-240V  
120V for  
NORTH AMERICA  
Dimmer not included  
Dimmer non incluso

equipment \*

**AP/PL 45**  
6 x E27 LED MAX 12W

**AP/PL 60**  
6 x E27 LED MAX 12W

**SO 45**  
6 x E27 LED MAX 12W

**SO 60**  
6 x E27 LED MAX 12W

\* 6 x E27 3,4W INCLUDED

symbols

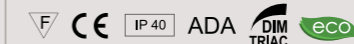

photometric test DROP PL 60

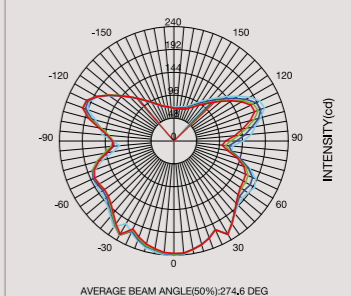

energy label

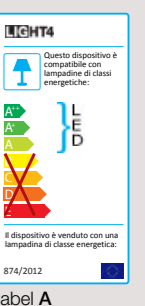





**FRAME**  
AND GAME  
OF LIGHT

## FRAME collection

[En] → **Signs and drawings made of light.** The linear LED light-source is the soul of this range: quality of light, minimal size and modularity. The extruded aluminium profile which contains the light-source is both a decorative and a structural element. The light is filtered by an opal PMMA profile that illuminates the underside of the fixture, giving the impression that the light beam is levitating. The different lengths of profile and the flexibility of the joining blocks make this range modular and easy to personalize.



### Segni e di-segni di luce

[It] → La sorgente luminosa lineare a LED, è l'anima della collezione: qualità della luce, ingombro minimo e modulare.

Il profilo estruso in alluminio, in cui alloggia il LED, diventa sia elemento decorativo che strutturale.

La luce che viene filtrata dal profilo in PMMA ne illumina la parte inferiore satinata, dando l'illusione che la fascia luminosa sia sospesa e galleggi nel vuoto. Le diverse dimensioni dei profili, e la flessibilità degli incastri, rendono l'oggetto modulare e personalizzabile.

### Lichtzeichen und Lichtzeichnungen

[De] → Die lineare LED Lichtquelle ist die Seele der Kollektion: Lichtqualität, geringere und modulare Stellfläche.

Das Aluminium-Strangpressprofil, in dem sich das LED befindet, wirkt dekorativ und auch als Strukturelement. Das Licht, das durch das Profil der PMMA gefiltert wird, beleuchtet die matte Unterseite, sodass wir die Täuschung haben, dass das helle Band im Leeren hängt und schwebt. Die verschiedenen Größen der Profile und die Flexibilität der Gelenke bilden das Objekt als modular und anpassbar.

### Знаки и анти-знаки света

[Ru] → Идея коллекции в линейном светодиодном источнике, его небольших размерах и модульности. Алюминиевый профиль, на котором находятся светодиоды, становится декоративно-структурным элементом. Свет, который поступает через профиль из полиметилметакрилата, освещает нижнюю матовую часть, и создается впечатление, что светящаяся полоса как бы парит в воздухе. Различные размеры профилей и возможность их совмещения делают эту модель универсальной для модулирования по персональным запросам.

علامات ورسومات مصنوعة من الضوء

[Ar] → الخطي، الضوء LED المصدر، هو روح هذا النطاق: نوعية الضوء، والحد الأدنى حجم والنمطية. الألومنيوم المقذوف الذي يحتوي على مصدر للضوء قديكون على حد سواء كل من الديكور والعنصر الهيكلي. يتم تصفية الضوء من خلال أوبال "ب" م "أ" الذي يضئ الجانب السفلي من الجهاز، وإعطاء الانطباع بأن تتعاين ضوء والرفع أطوال مختلفة. تجعل هذا النطاق سهلة للتخصيص.



## FRAME

STELLA  
suspension

dimensions  
Ø 170 x H 7 cm

color  
matt gold anodised





## FRAME

ESAGONO 30 / COMPO 30x90  
/ OTTAGONO 30

suspensions

### colors

matt silver anodised  
white 9010  
matt gold anodised

[En] → The FRAME collection is expanded through new corner elements with a 120° e 135° angle. This allows you to create hexagonal and octagonal shapes plus many others. Two new finishes: aluminium anodized gold or aluminium anodized natural. White ceiling canopy.

[It] → La collezione FRAME viene ampliata grazie ai due nuovi modelli di giunto angolare a 120° e 135°. Sarà possibile ottenere forme esagonali, ottagonali e altre fantasiose composizioni. Due nuove finiture: alluminio anodizzato naturale e alluminio anodizzato oro. Rosone a soffitto bianco.







## **FRAME**

**COMPO 30x120**  
suspension

**dimensions**  
W 36 x L 126 x H 7 cm

**color**  
dove 1019





## FRAME

### COMPO MIX 30x180

suspension

#### dimensions

W 36 x L 195 x H 7 cm

#### color

matt silver anodised

[En] → The flexibility of FRAME is possible thanks to carved solid aluminium fixing elements, available as end caps, double joints for lines, and corners. To get the Compo Mix 30x180, as per photo, you need six corner elements and two end caps, which allow both to hang the composition and to fix the extruded aluminium profiles.

[It] → La flessibilità di FRAME è possibile grazie all'elemento di fissaggio in alluminio ricavato dal pieno, disponibile nelle versioni singolo, doppio o angolare. Per ottenere Compo Mix 30x180, in foto, sono necessari sei elementi angolari e due singoli, i quali permettono la sospensione della composizione e il fissaggio dei profili estrusi in alluminio.

**FRAME**

**COMPO MIX 30x180**

suspension

**dimensions**

W 36 x L 195 x H 7 cm

**color**

matt silver anodised



## **FRAME**

**COMPO MIX 30x180**

suspension

**dimensions**

W 36 x L 195 x H 7 cm

**color**

matt silver anodised



## **FRAME**

**SO 90L**

suspension

**dimensions**

L 96 x H 7 cm

**color**

white 9010



[En] → FRAME is also available as a wall sconce in three different sizes. It can be mounted with the light source facing downwards or upwards and in both versions the distance from the wall is minimal.

[It] → FRAME è disponibile anche nella versione a parete in tre diverse dimensioni. Può essere montata con la sorgente luminosa rivolta verso il basso o verso l'alto e in entrambe le versioni la sporgenza rispetto alla superficie del muro è minima.

## **FRAME**

### **AP 30**

wall lamp

### **dimensions**

W 36 x H 7 x DPT 8 cm

### **color**

dove 1019



## **FRAME**

### **AP 60**

wall lamp

### **dimensions**

W 66 x H 7 x DPT 8 cm

### **color**

white 9010

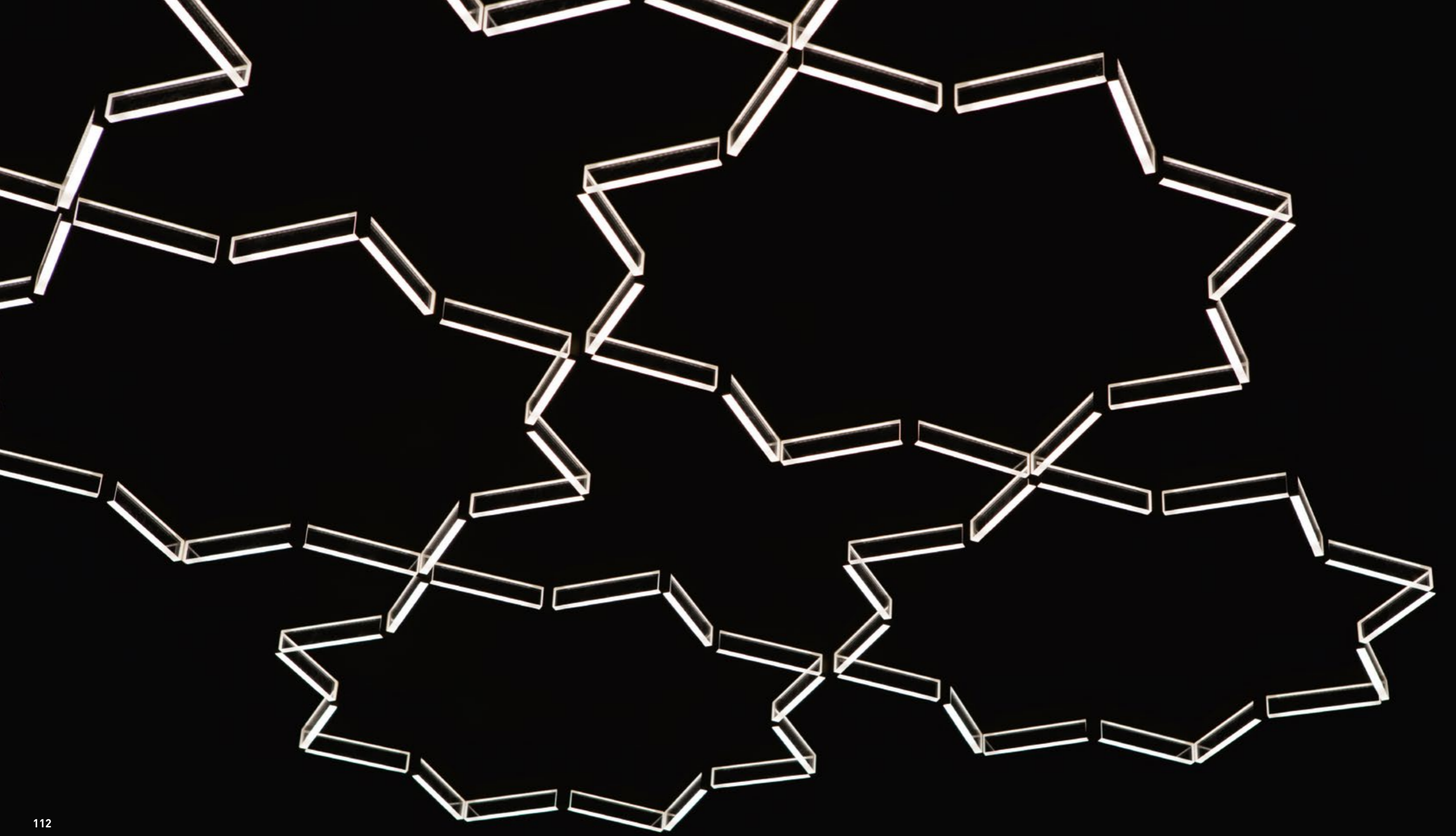



## FRAME collection

design Brian Rasmussen

[En] → White powder-coated extruded aluminium profile, RAL 9010 or dove color RAL 1019. Transparent PMMA diffuser, satin finished on top and bottom edges. Fixing element in carved solid aluminium, row finish in single, double and corner version. Strip LED 20W/m 24V.

[It] → Profilo strutturale in alluminio estruso verniciato a polveri bianco RAL 9010 o tortora RAL 1019. Diffusore in PMMA trasparente con lato superiore e inferiore satinati. Elemento di fissaggio in alluminio ricavato dal pieno, finitura naturale nelle versioni singolo, doppio e angolare. Sorgente LED Strip 20W/m 24V.

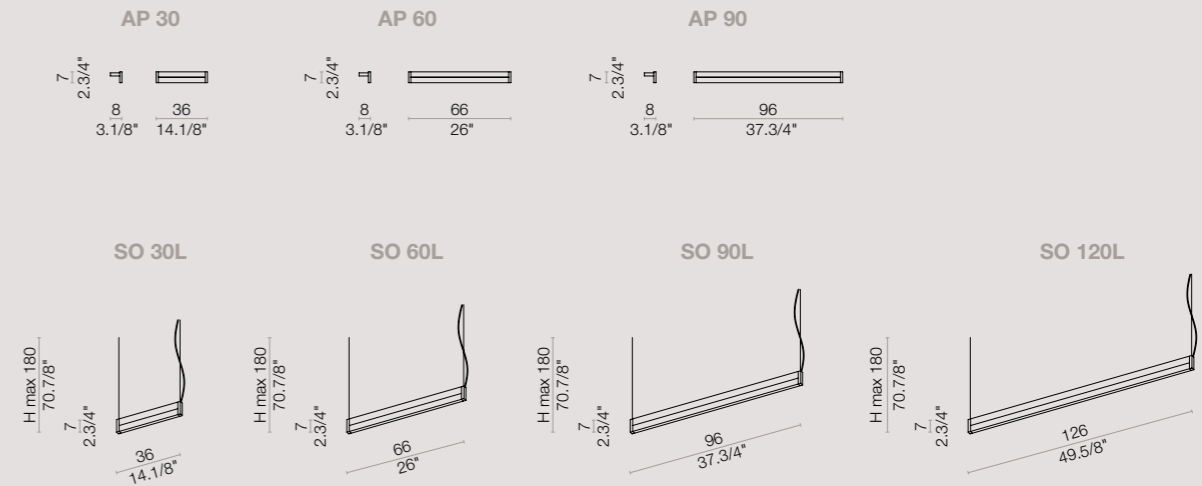

### colors

	white / bianco RAL 9010
	dove / tortora RAL 1019
	black anodised / nero anodizzato
	matt silver anodised / anodizzato argento opaco
	matt gold anodised / anodizzato oro opaco

### material

aluminium and PMMA  
alluminio e PMMA

### light source

LED 220-240V  
120V for  
NORTH AMERICA

### equipment

<b>AP 30</b>	5W LED 3000°K Im720
<b>AP 60</b>	10W LED 3000°K Im1440
<b>AP 90</b>	14W LED 3000°K Im2160
<b>SO 30L</b>	5W LED 3000°K Im720
<b>SO 60L</b>	10W LED 3000°K Im1440
<b>SO 90L</b>	14W LED 3000°K Im2160
<b>SO 120L</b>	19W LED 3000°K Im2880

### symbols



COMPO 30x30

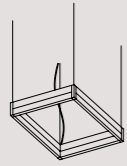

COMPO 30x60

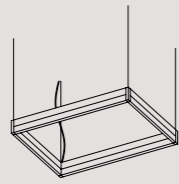

COMPO 30x90

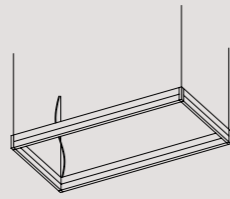

COMPO 30x120

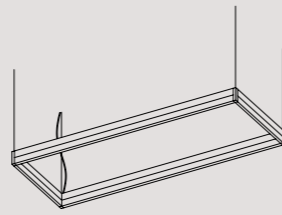

COMPO 60x60

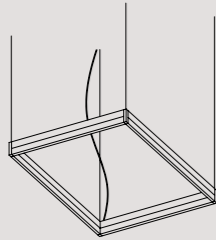

COMPO 90x90

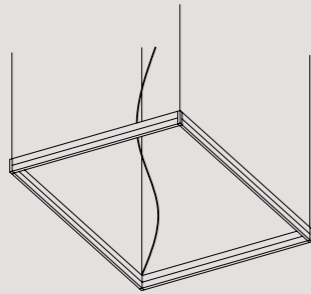

COMPO 120x120

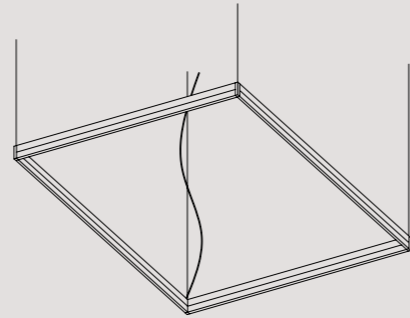

COMPO MIX 30x180

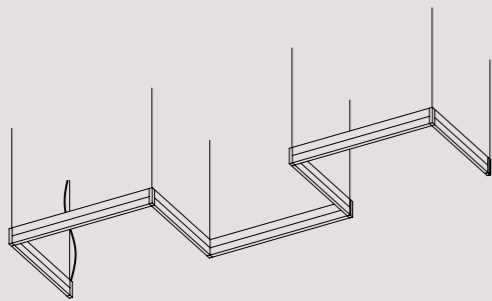

ESAGONO 30 - Ø 70

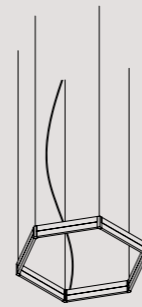

ESAGONO 60 - Ø 130

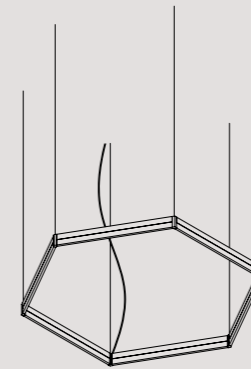

ESAGONO 90 - Ø 190

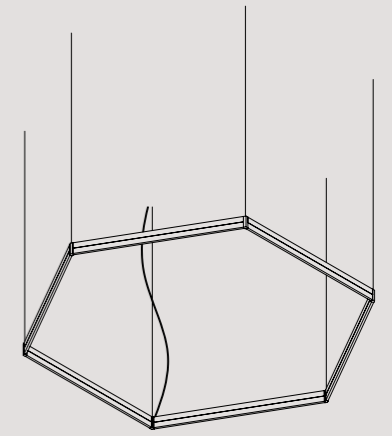

OTTAGONO 30 - Ø 90

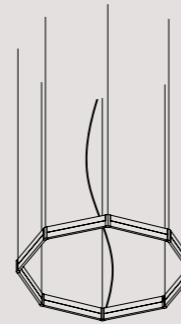

OTTAGONO 60 - Ø 170

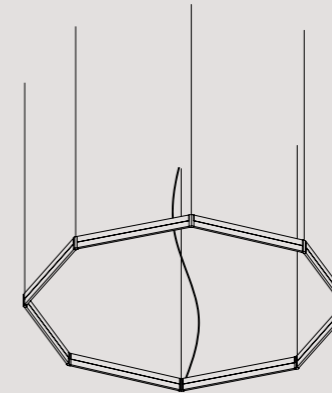

STELLA - Ø 170

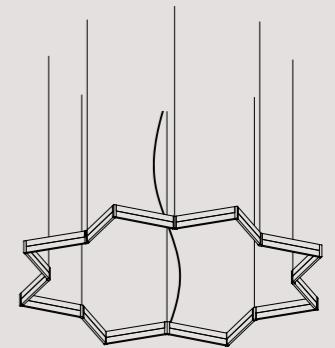

equipment

**COMPO 30x30**

19W LED 3000°K lm2880

**COMPO 30x60**

29W LED 3000°K lm4320

**COMPO 30x90**

38W LED 3000°K lm5760

**COMPO 30x120**

48W LED 3000°K lm7200

**COMPO 60x60**

38W LED 3000°K lm5780

**COMPO 90x90**

58W LED 3000°K lm8640

**COMPO 120x120**

77W LED 3000°K lm11520

**COMPO MIX 30x180**

48W LED 3000°K lm7200

**ESAGONO 30 - Ø 70**

29W LED 3000°K lm4320

**ESAGONO 60 - Ø 130**

56W LED 3000°K lm8640

**ESAGONO 90 - Ø 190**

83W LED 3000°K lm12960

**OTTAGONO 30 - Ø 90**

39W LED 3000°K lm5760

**OTTAGONO 60 - Ø 170**

79W LED 3000°K lm11520

**STELLA - Ø 170**

79W LED 3000°K lm11520

Available 4000°K / Disponibile 4000°K

Dimmerable LED driver available / Disponibile LED driver dimmerabile

symbols



photometric test FRAME 30

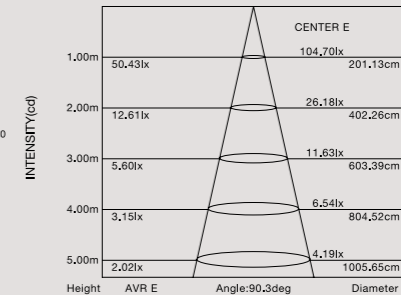
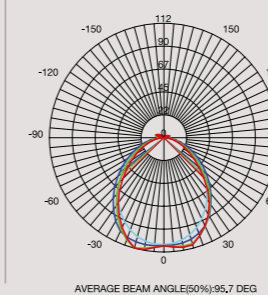

energy label

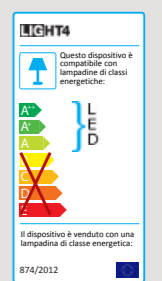



ME  
MYSELF  
AND  
IO

## IO collection

[En] → **Cone of light.** The slow process of transformation of a tubular metal section to a slim and tapered cone, seems to attribute to the light-source the act of freezing the beam of light into a solid object. The accurate perfection of the surface, the specific weight and substance of the material, in contrast with the apparent fragility of the product, testify the value of the workmanship, all made in Italy. Last but not least, the varying color options, give the product an elegant and contemporary character.



### Cono di luce

[It] → Il lento processo di trasformazione di un elemento tubolare in ferro in un cono dalla forma affusolata e snella, sembra voler attribuire alla luce l'atto di aver congelato e reso solido un fascio luminoso.

L'accurata levigatezza della superficie, il peso specifico e la sostanza del materiale, in contrasto con l'apparente esilità dell'oggetto, testimoniano il grande valore della lavorazione rigorosamente made in Italy. Infine, la svariata gamma di colorazioni, in cui è disponibile la lampada, ne conferisce un carattere elegante e contemporaneo.

### Lichtkegel

[De] → Der langsame Prozess der Transformation von einem rohrförmigen Eisenelement in einen konischen und spindelförmigen Kegel, scheint für das Licht selbst den Grund für das Einfrieren und Erstarren des Lichtstrahls zu geben. Die genaue Oberflächenglätte, das spezifische Gewicht und die Substanz des Materials, im Gegensatz zu der scheinbaren Düntheit des Objekts, ist Ausdruck des großen Wertes der genauen Verarbeitung "Made in Italy". Schließlich ergibt die abwechslungsreiche Auswahl an Farben ein elegantes und zeitgemäßes Design.

### Световой конус

[Ru] → Кажется, что постепенный процесс превращения металлической трубы в стройный конус, являет свету акт трансформации светового луча в осязаемый источник света. Идеально гладкая поверхность, вес и специальный материал играют на контрасте видимой легкости лампы, что свидетельствует о высоком качестве проектирования светильника, полностью произведенного в Италии. Возможность изготовления лампы в большом количестве разнообразнейших цветов придает ей элегантный и современный вид.

### إيو

[Ar] → المنتج المصنوع في إيطاليا يمثل قطعة فنية تظهر فيها الدقة كما البساطة باستخدام أنبوب استانسليس ستيل و ينتهي بشكل مخروطي بقمة الإتقان ، كما و تأتي القطعة بعدة ألوان مما يعطي المنتج طابع عصري و أنيق.







white 9010    black 9005    chrome    concrete

[En] → Powder-coated metal conical tube available in 2 colors, chrome plated and concrete finish. Chrome plated metal cord grip. GU10 LED for direct light. For all colors a special metal chromed detail is applied between the fixture and the electrical wire that supports it.

[It] → Tubo in metallo conificato verniciato a polveri nei 2 colori, cromato e finitura cemento. Particolare blocca cavo in metallo tornito ricavato dal pieno finitura cromo. Sorgente LED attacco GU10 con emissione di luce diretta. A tutte le varianti è applicato un particolare tornito in metallo cromato posto tra il corpo illuminante e il cavo di alimentazione che lo sostiene.

SO



MINI SO

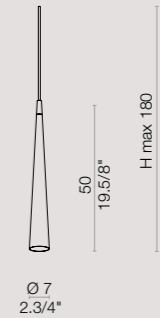

SO 3L

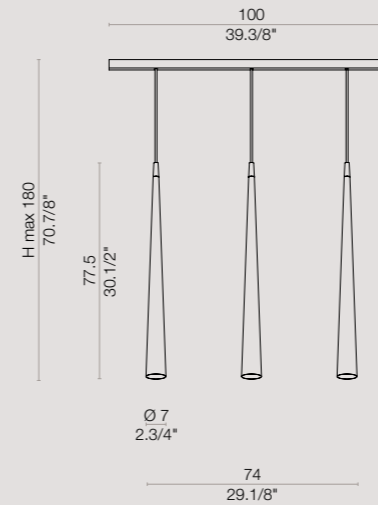

MINI SO 3L

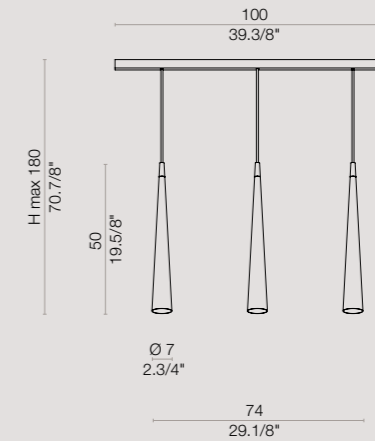

material

metal  
metallo

equipment

**SO / MINI SO**  
1 x 7W LED GU10 3000°K lm450

**SO 3L / MINI SO 3L**  
3 x 7W LED GU10 3000°K lm450

light source

LED 220-240V  
120V for  
NORTH AMERICA

energy label



label A

photometric test SO

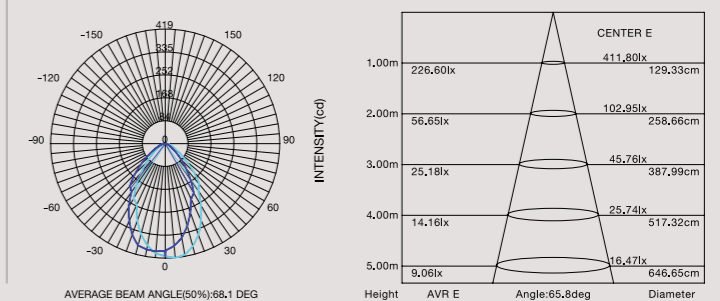



# INFINITE SHADES OF LIGHT







## ITASHADES

### IS RE SO 150

suspension

### dimensions

L 150 x W 45 x H 10 cm

### color

dove 66.8003.82

## ITASHADES *collection*

[En] → **The lampshade with a more contemporary take.** Technological innovation has made it possible for us to move the light-source from the center of a lamp to its perimeter. This simple opportunity has given us the chance to create a new archetype for the traditional lampshade, a very low profile and a very lightweight look as the center of the shade can be hollow and freed of all technical limitations previously imposed by lamp technology. The result is an object that is distinguished by its simplicity and purity that declares its hi-tech personality once illuminated.

### Il paralume rivisitato in chiave contemporanea

[It] → L'innovazione tecnologica ha reso possibile lo spostamento della sorgente luminosa dal centro della lampada al perimetro della stessa. Questo semplice gesto ha dato forma a un nuovo archetipo del classico paralume in tessuto di altezza molto contenuta in cui il centro viene liberato da qualsiasi elemento tecnico. Il risultato è un oggetto che si distingue per la sua semplicità e purezza formale che dichiara il suo carattere hi-tech una volta illuminato.

### Der Lampenschirm in einem zeitgenössischen Stil überarbeitet

[De] → Technologische Innovation ermöglicht es, die Lichtquelle von der Mitte der Lampe auf den Umfang zu bewegen. Das Zentrum wurde von jedem technischen Element befreit. Das Ergebnis ist ein Objekt, das durch seine Einfachheit und Reinheit der Form besticht und sofern es beleuchtet ist seinen Hi-Tech Charakter zeigt.

### Абажур в его современном прочтении

[Ru] → Технологические инновации позволили передвинуть источник света с его центрального классического положения в периметр лампы. Эта возможность обрела форму в новом типе классического абажура в ткани, где центральная часть освобождается от всех технических элементов. Результат – лампа, отличающаяся простой и чистой формой и демонстрирующая свой хай-тек характер как только мы ее включаем.

ايتاشا شادن

[Ar] → جعل هذا الابتكار التكنولوجي من الممكن بالنسبة لنا تحريك مصدر الضوء من مركز المصباح لمحيطها. أعطانا هذا الفرصة لخلق النموذج الأصلي الجديد لعاكس الضوء التقليدي، خفيفة الوزن جدا كمرکز للظل.





## **ITASHADES**

**IS CY SO 70**  
suspension

**dimensions**  
Ø 70 x H 10 cm

**color**  
brown 66.8003.52

[En] → All models have a prismatic PMMA cover. This element shields the light source and diffuses the light uniformly upwards, it also prevents dust accumulating in the fitting.

[It] → Tutti i modelli, hanno una copertura in PMMA prismatico. Questo elemento oltre a chiudere la parte superiore della lampada impedendo che si accumuli lo sporco, schermo la sorgente luminosa e diffonde la luce in modo uniforme verso l'alto.

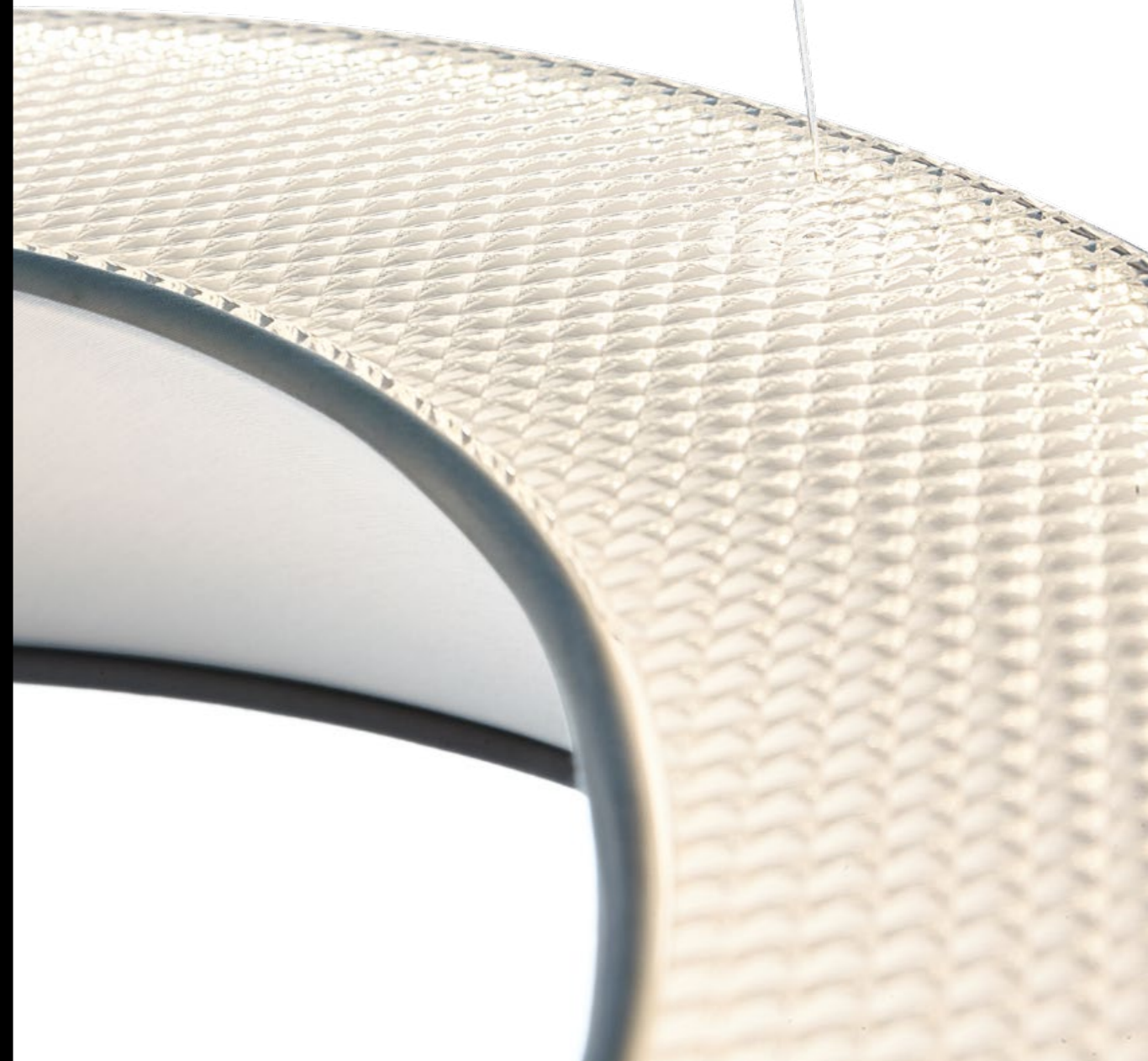

IS CY SO 50

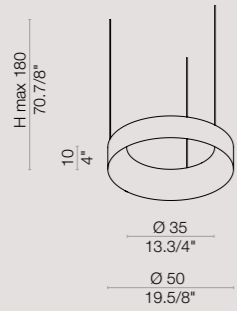

IS CY SO 70

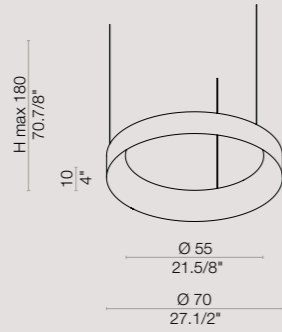

IS CY SO 100

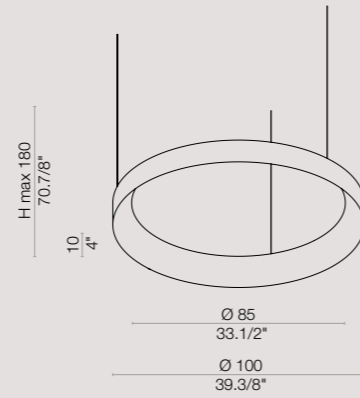

IS RE SO 120

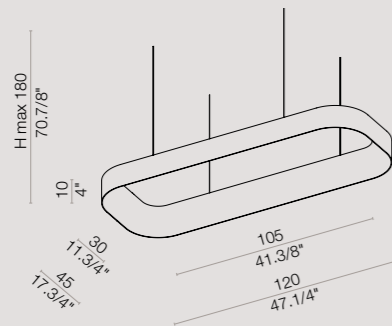

IS RE SO 150

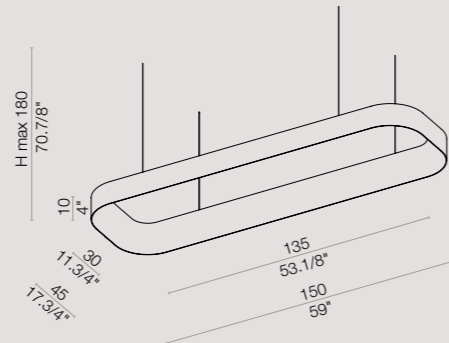

colors

white / bianco 66.8003.11  
dove / tortora 66.8003.82

brown / marrone 66.8003.52  
bordeaux 66.8003.09

[En] → The ITASHADES collection is available in four colors. All shades come in a range of soft and contemporary colors that fit discreetly into any context. Custom colours on demand.

[It] → La collezione ITASHADES è disponibile in quattro colorazioni. Tutte le tonalità rientrano in una gamma di colori tenui e contemporanei che si adattano in modo discreto ad ogni contesto. Altri colori disponibili su richiesta.



[En] → Unit composed by: outside shade in opaque PVC completed with cotton fabric available in 4 colors. Inside shade in transparent PVC completed with white cotton fabric. Prismatic PMMA cover. Strip LED 12,5W/m 24V.

[It] → Oggetto composto da: paralume esterno in PVC coprente accoppiato con tessuto cotone nei 4 colori disponibili e paralume interno in PVC traslucido accoppiato con tessuto cotone bianco. Copertura in PMMA prismatico. Sorgente LED Strip 12,5W/m 24V.

material

fabric + PVC  
tessuto + PVC

light source

LED 220-240V  
120V for NORTH AMERICA

equipment

- IS CY SO 50**  
19W LED 3000K 2500 lm
- IS CY SO 70**  
26W LED 3000K 3570 lm
- IS CY SO 100**  
38W LED 3000K 5100 lm
- IS RE SO 120**  
38W LED 3000K 5100 lm
- IS RE SO 150**  
45W LED 3000K 6120 lm

symbols



photometric test IS CY SO 50

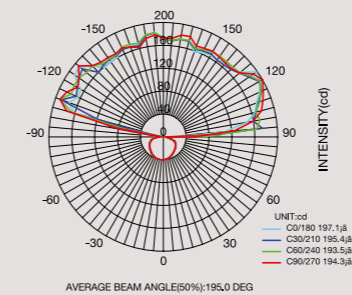

energy label

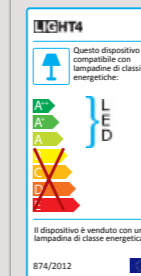

label A

Available 4000°K /  
Disponibile 4000°K

Dimmerable LED driver  
available / Disponibile LED  
driver dimmerabile



**JAM**  
YOUR  
WORLD  
FULL  
OF  
LIGHT

## **JAM** collection

[En] → **Braidings of light.** JAM is a suspension lamp characterised by a metal dome enriched by a complex laser cutted ornament. The contrast between the decorated dome and the minimal superior cone creates an aesthetic balance. The light source is located inside the cone shaped element giving the light fixture a minimal aspect without any technical elements visible. The fixture is suspended with three steel wires.



### **Intrecci di luce**

[It] → JAM è una sospensione composta da un paralume a fasce di metallo realizzato con la tecnica del laser 3D, che dona precisione al movimento delle curve, sovrapposto da un tronco di cono che gli dona stabilità, creando delle geometrie ornamentali. La fonte luminosa è nascosta nella parte superiore, realizzando un interessante contrasto tra vuoti e pieni. La lampada è sostenuta da tre cavi in acciaio che ne permettono la regolazione in altezza.



## **JAM**

**SO 45 / SO 30**  
suspensions

**dimensions**  
Ø 45 x H 30 cm  
Ø 30 x H 22 cm

**colors**  
bronze  
white RAL 9010

## **JAM**

### **SO 45**

suspension

### **dimensions**

Ø 45 x H 30 cm

### **color**

white RAL 9010

**light**  
↓

↑  
**light**  
↓

↑  
**light**

[En] → The JAM SO Ø 45 has double light emission allowing the customer to choose whether to use the direct light source downwards, the indirect light source upwards or both. This feature adds another point to the exclusivity of the product.

[It] → Sono molteplici le possibilità di utilizzo della lampada JAM, la cui fonte luminosa può essere utilizzata a scelta verso il basso o verso l'alto, oppure usufruendo della doppia accensione, donando al prodotto un carattere ancor più volubile e prezioso.



[En] → The JAM is available in two different finishes. The white that emphasizes the minimal and contemporary aspect of the product and the bronze recalls the archetype of the classical dome. The collection is available in two measures: Ø 45 cm and Ø 30 cm.

[it] → L'elegante metallo di JAM viene fornito in due diverse finiture ossia il moderno bianco che rimanda alle forme pulite e moderne e il bronzo che ci riporta agli archetipi strutturali dei prodotti classici. La collezione è disponibile in due misure: diametro 45 cm e diametro 30 cm.



## **JAM**

**SO 30**  
suspension

**dimensions**  
Ø 30 x H 22 cm

**color**  
bronze



## **JAM**

**SO 30 / SO 45**  
suspensions

**dimensions**  
Ø 30 x H 22 cm  
Ø 45 x H 30 cm

**colors**  
white RAL 9010  
bronze



### **JAM sphere**

**SO 60**

suspension

**dimensions**

Ø 60 x H 59 cm

**color**

polished gold

### **JAM**

→ **sphere**

[En] → The decorative aspect of the collection is emphasized in the SPHERE version in which the dome is doubled creating a perfect sphere. The light effects of the JAM SPHERE are a result of the elegant and geometrical decoration.

[It] → La fantasia che caratterizza JAM è ulteriormente dimostrata dalla versione SPHERE composta da due paralumi a fasce posizionati l'uno speculare all'altro creando così una forma sferica che accentua ancora di più i giochi di luce creati dalle scomposizioni del solido.

### **JAM sphere**

**SO 60**

suspension

**dimensions**

Ø 60 x H 59 cm

**color**

polished gold





**JAM sphere**

**SO 30**  
suspension

**dimensions**  
Ø 30 x H 29 cm

**color**  
polished gold

**JAM sphere**

**SO 30**  
suspension

**dimensions**  
Ø 30 x H 29 cm

**color**  
polished gold



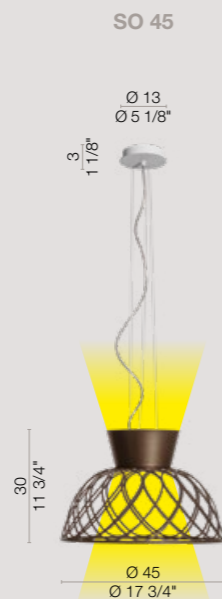

material

metal and PMMA  
metallo e PMMA

light source

**SO 30**  
1 x max 8W LED GU10. **IMPORTANT: ONLY LED**  
**SO 45**  
4 x max 8W LED GU10. **IMPORTANT: ONLY LED**

energy label



label A

colors

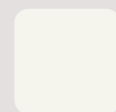

white / bianco  
RAL 9010



bronze / bronzo

symbols



**N.B. ceiling canopy** only white RAL 9010  
**rosone a soffitto** solo bianco RAL 9010

material

**JAM sphere**  
metal  
metallo

light source

**SO 30/45/60**  
1 x max 70W E27 HALO  
1 x max 23W E27 FLUO  
1 x E27 SUITABLE FOR LED LAMPS

colors

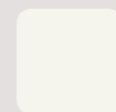

white / bianco  
RAL 9010



polished gold  
/ oro lucido

**N.B. ceiling canopy** in color  
**rosone a soffitto** in tinta

symbols



energy label

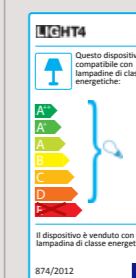

label B



EVERYTHING  
SPARKLES  
UNDER A  
**MISSTRASS**



## **MISSTRASS**

**PL 70**  
ceiling lamp

**dimensions**  
Ø 70 x H 50 cm

**colors**  
crystal  
honey

## **MISSTRASS** collection

[En] → For those who love to invent and create personal solutions.

Glaring flashes of colour, magical glows, infinite luminescence characterize the MISSTRASS collection. With its modularity, it offers multiple interpretative paths, depending on personal taste: magical and mysterious, or regular and structured.

The system of attachment is patented, the frame is in polished stainless steel.



[It] → Per chi ama inventarsi e creare soluzioni personali. Sprazzi rutilanti di colore, bagliori magici, infinite luminescenze caratterizzano la collezione MISSTRASS. Essa offre, con la sua componibilità, molteplici strade interpretative, a seconda del gusto personale: magico e misterioso, oppure regolare e strutturato. Il sistema di aggancio è brevettato, la struttura della montatura è in acciaio inox lucido.

## MISSTRASS

S0 70  
suspension

dimensions  
Ø 70 x H 50 cm

colors  
crystal  
coal

## MISSTRASS

AP  
wall lamp

dimensions  
L 42 x W 24 x H 46 cm

colors  
crystal  
coal



Lenbach Palais, Rilano no. 6 / Munich [DE]

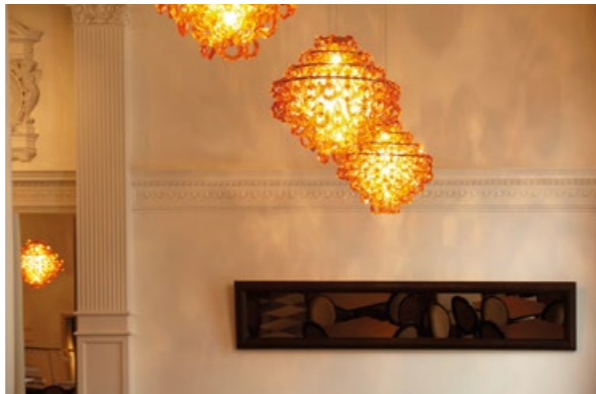

Vinzenzmurr / Bavaria [DE]





Showroom CVDM / Lecco (IT)

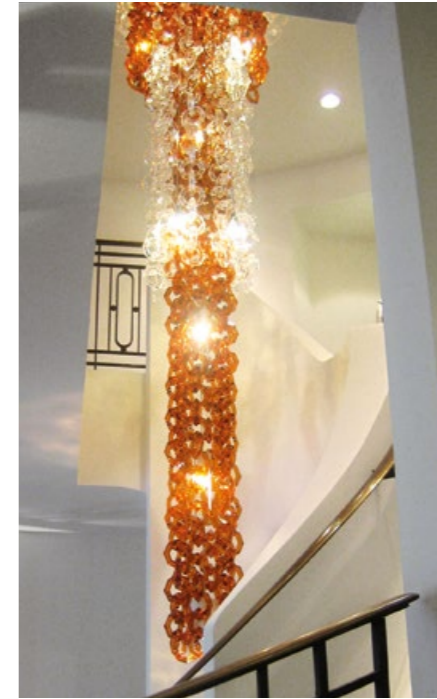

Boutique C. Wirschke / Düsseldorf (DE)



Light & Building / Frankfurt [DE]



Crowne Plaza / Saint Petersburg [RU]

**MISSTRASS** collection

design Mauro Marzollo



[En] → Lamp collection composed by modular elements in PMMA in the following colours: crystal, honey & coal.

[It] → Collezione di lampade composte da elementi in PMMA (metacrilato) disponibili in colore: cristallo, miele e carbone. Montatura in inox lucido.

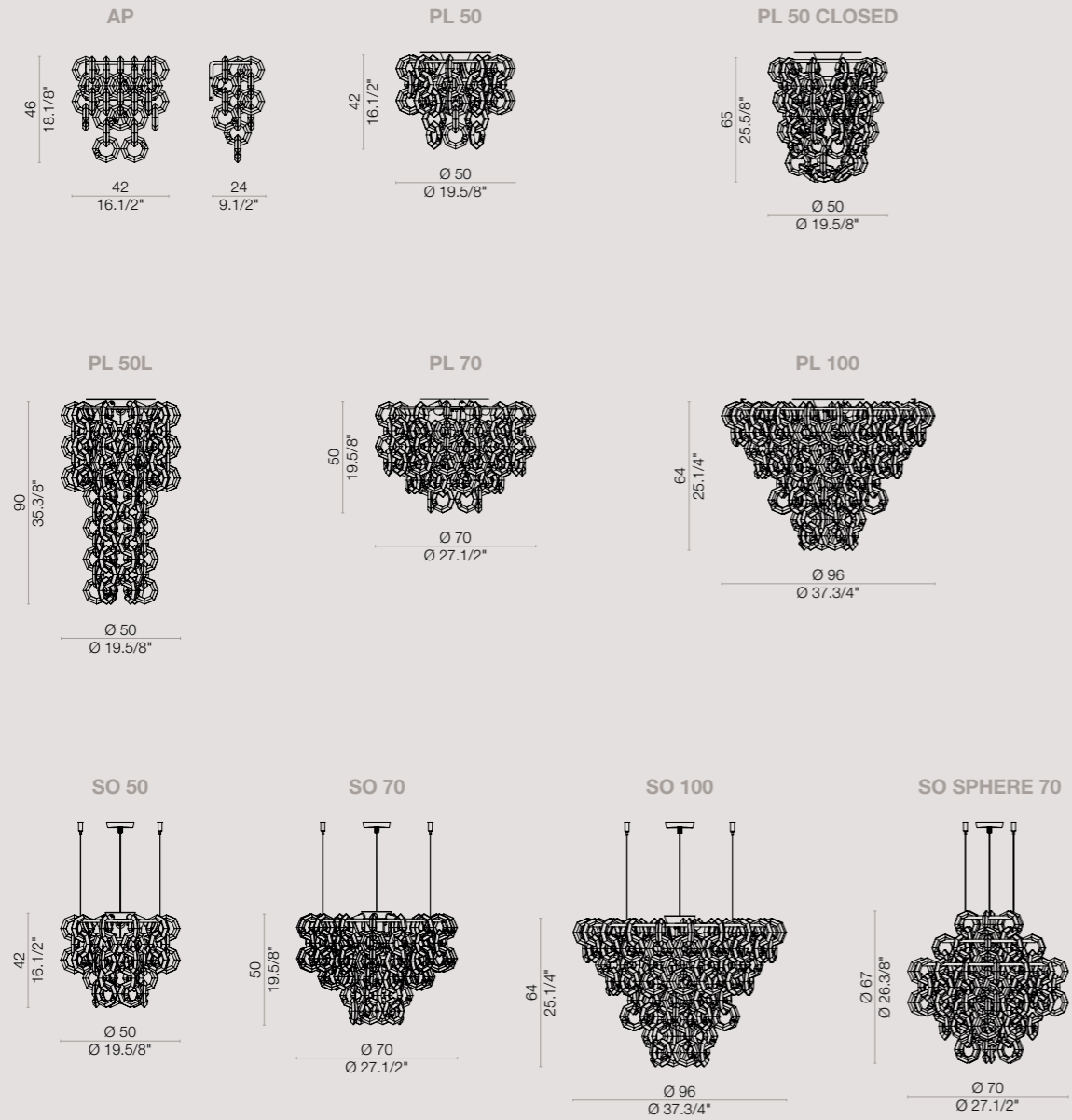

colors

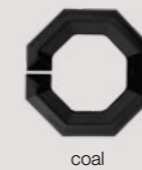

material

metal + PMMA  
metallo + PMMA

symbols



equipment

- AP**  
2 x E14 SUITABLE FOR LED LAMPS
- PL 50**  
5 x E14 SUITABLE FOR LED LAMPS
- PL 50 CLOSED**  
5 x E14 SUITABLE FOR LED LAMPS
- PL 50L**  
5 x E14 SUITABLE FOR LED LAMPS

- PL 70**  
6 x E27 SUITABLE FOR LED LAMPS  
+ 3 x E14 SUITABLE FOR LED LAMPS
- PL 100**  
6 x E27 SUITABLE FOR LED LAMPS  
+ 3 x E14 SUITABLE FOR LED LAMPS
- SO 50**  
5 x E14 SUITABLE FOR LED LAMPS

- SO 70**  
6 x E27 SUITABLE FOR LED LAMPS  
+ 3 x E14 SUITABLE FOR LED LAMPS
- SO 100**  
6 x E27 SUITABLE FOR LED LAMPS  
+ 3 x E14 SUITABLE FOR LED LAMPS
- SPHERE 70**  
3 x E27 SUITABLE FOR LED LAMPS

energy label

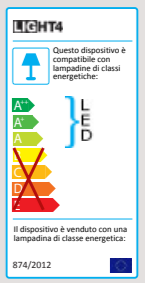



SUNSHINE  
IN THE  
MLAMP SHADES



## **MLAMPSHADES** collection

[En] → **Fabric + Light = Lampshade.**

This archetype is revisited by LIGHT4 through a search for contemporary fabrics and an innovative prismatic PMMA diffuser. The diffuser rests on the edge of the lampshade, thus avoiding any visible fixing element. Less is more.



### **Tessuto + Luce = Paralume**

[It] → Questo archetipo viene rivisitato da LIGHT4 attraverso una ricerca di tessuti contemporanei e un diffusore innovativo in PMMA prismatico. Il diffusore si appoggia sul bordo del paralume evitando in questo modo qualsiasi elemento di fissaggio a vista. Less is more.



## **MLAMPSHADES**

**SQ AP**  
wall lamp

**dimensions**  
L 25 x W 12,5 x H 25 cm

**color**  
brown 06



## **MLAMPSHADES**

**SQ S0 60**  
suspension

**dimensions**  
L 60 x W 60 x H 30 cm

**color**  
tobacco 09



172

173

## MLAMPSHADES

### CY CO

table lamp

### dimensions

Ø 12 x H 25 cm

### color

tobacco 09







Light4 Headquarter / Quinto di Treviso (IT)



Showroom CVDM / Lecco (IT)



[En] → A collection of lampshades in a variety of fabrics. Prismatic methacrylate diffuser. White lacquered metal fixtures and base plates.

[It] → Collezione di paralumi con vari tessuti. Diffusore in metacrilato prismatico. Montature e basi verniciate bianco.

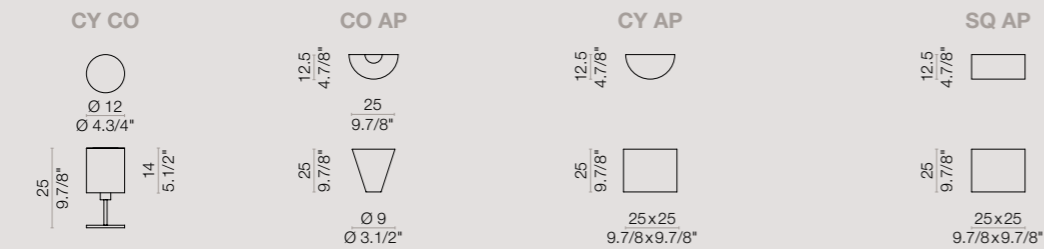
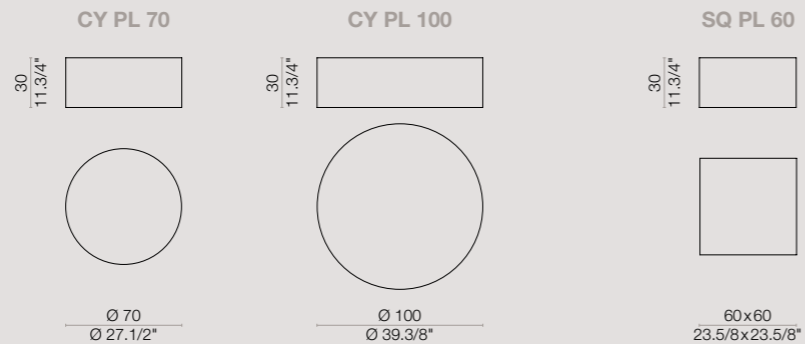
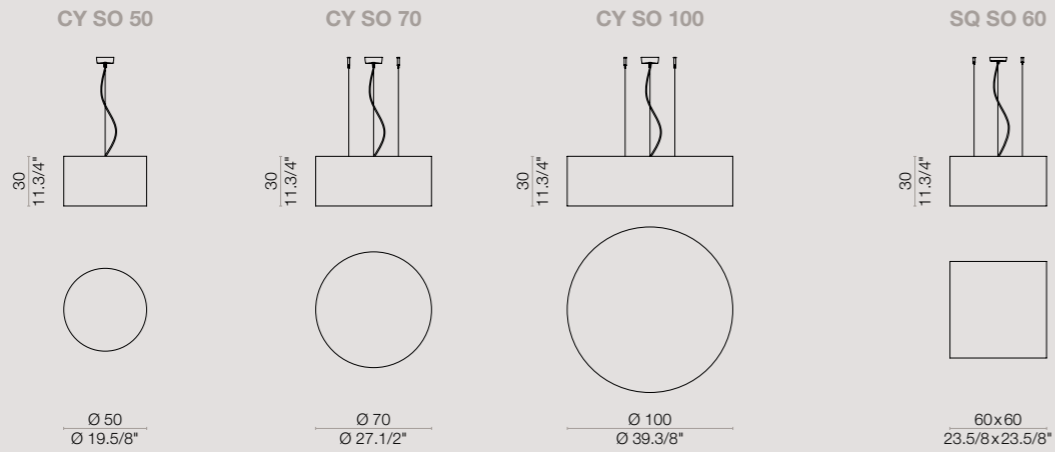

material

fabric + methacrylate  
tessuto + metacrilato

**N.B. anti glare shield**  
in micro-prismatic  
methacrylate included  
**schermo paraluce** in  
metacrilato prismatico  
incluso

colors



\* this fabric might have an **irregular texture**  
questo tessuto potrebbe avere una **tramatura irregolare**

energy label



label A

equipment

<b>CY SO 50</b> 1 x E27 SUITABLE FOR LED LAMPS	<b>CY PL 70</b> 3 x E27 SUITABLE FOR LED LAMPS	<b>CO AP</b> 1 x E27 SUITABLE FOR LED LAMPS
<b>CY SO 70</b> 3 x E27 SUITABLE FOR LED LAMPS	<b>CY PL 100</b> 6 x E27 SUITABLE FOR LED LAMPS	<b>CY AP</b> 1 x E27 SUITABLE FOR LED LAMPS
<b>CY SO 100</b> 6 x E27 SUITABLE FOR LED LAMPS	<b>SQ PL 60</b> 3 x E27 SUITABLE FOR LED LAMPS	<b>SQ AP</b> 1 x E27 SUITABLE FOR LED LAMPS
<b>SQ SO 60</b> 3 x E27 SUITABLE FOR LED LAMPS	<b>CY CO</b> 1 x E14 SUITABLE FOR LED LAMPS	

symbols





MORE  
THAN  
A LIGHT  
MULTI4

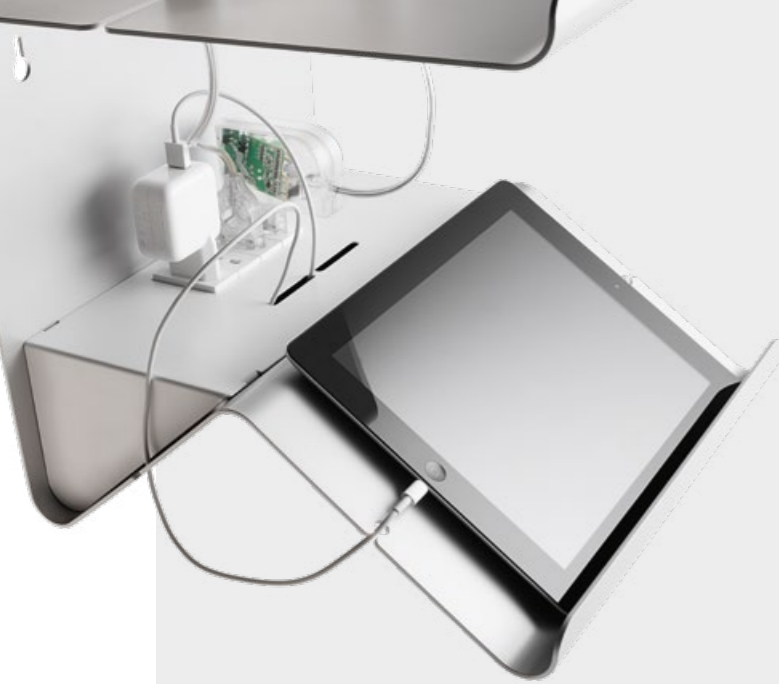

## **MULTI4** collection

[En] → **Simply usefull.** The MULTI4 platform is an ergonomic multifunctional furnishing accessory; a simple and safe shelf, on which mobile phones, tablets and other small hi-tech electronic devices can be recharged.

### **Semplicemente utile**

[It] → La piattaforma MULTI4 è un oggetto d'arredo multifunzionale dal design ergonomico che permette un facile e sicuro piano d'appoggio e ricarica per cellulari, tablet e qualsiasi altro piccolo apparecchio elettronico hi-tech.

### **Einfach sinnvoll**

[De] → Die MULTI4 Plattform ist ein ergonomischer Multifunktionseinrichtung Accessoire; eine einfache und sichere Ablage, auf der Handys, Tablets und andere kleine hallo-Tech-elektronische Geräte wieder aufgeladen werden können.

### **Просто полезным**

[Ru] → Платформа MULTI4 это многофункциональный аксессуар эргономичного дизайна, являющийся простой и безопасной опорной поверхностью и одновременно местом зарядки для мобильных телефонов, планшетов и любых других небольших электронных устройств хай-тек.

### **ببساطة مفيدة**

[Ar] → هو مريح تائيث متعدد الوظائف . انه رف بسيط وآمن، وعليه MULTI4 منصة فوضع الهواتف وغيرها من الأجهزة الإلكترونية الصغيرة خاصة بالتكنولوجيا الفائقة التي يمكن إعادة شحنها.





[En] → MULTI4 can be used as a simple floor-standing base unit or easily fastened to any wall. With its two slots it's possible to connect a small lampshade or a flexible reading LED lamp. It has a power strip for simultaneously recharging several electronic devices, with cable ducting to keep wires tidy. Curved aluminium makes the Multi4 platform strong and long-lasting. A quality top-design product entirely made in Italy.

[It] → MULTI4 può essere utilizzato come semplice base a terra o fissato a muro ed è provvisto di due incavi ai quali è possibile agganciare un piccolo abat-jour e/o un flessibile led da lettura. È dotato di multipresa per la ricarica contemporanea di più apparecchi elettronici e di passacavi per dare ordine all'intreccio di fili. L'utilizzo dell'alluminio curvato lo rende forte e durevole nel tempo. Un prodotto di qualità e di design interamente realizzato in Italia.



**A**



**B**



**C**

[En] → The MULTI4 is available with 3 different types of electrical outlets:

- A** 1 pcs. schuko socket, 1 pcs. bipolar socket, 1 pcs. USB socket
- B** 3 pcs. bipolar sockets, 1 pcs. USB socket
- C** 4 pcs. bipolar sockets

[It] → La MULTI4 è disponibile con 3 diversi tipi di prese elettriche:

- A** 1 presa schuko, 1 presa bipolare 2P+T, 1 presa USB
- B** 3 prese bipolare 2P+T, 1 presa USB
- C** 4 prese bipolare 2P+T



**MULTI4** collection

design Brian Rasmussen

colors



white / bianco  
RAL 9010



black / nero  
RAL 9005



brown / marrone  
RAL 8016



red / rosso  
RAL 3020



grey / grigio  
RAL 9006



accessories



lampshade lamp  
paralume



flex led reading lamp  
lampada led flessibile

description

4-Way Multi-Socket  
Multi presa elettrica 4 posti  
  
US and UK standards  
available on request

material

aluminium  
alluminio

equipment

**LAMPSHADE LAMP**  
1 x max 42W E14  
1 x max 12W E14  
1 x 5W LED E14 220-240V 2700°K lm350

**FLEX LED READING LAMP**  
1,2W LED 3000°K lm120

STRUCTURE

symbols

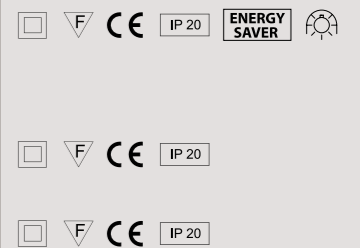

dimensions

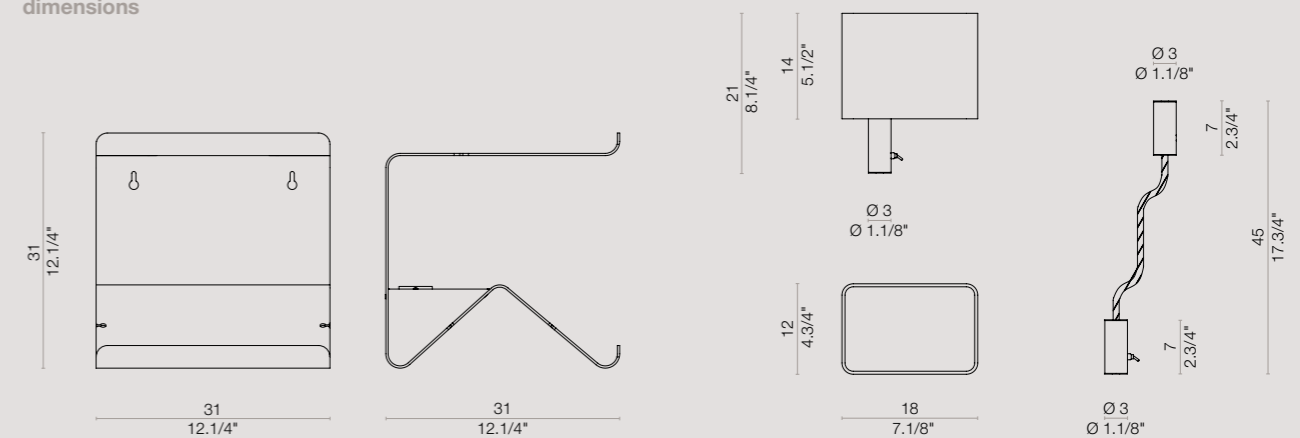

LOOK AT  
THE WORLD  
FROM A NEW  
OPTIK



## **OPTIK** collection

[En] → **Solid - Void.** This collection is composed by a cone in metal and a diffuser in PMMA. The minimal design of this collection is enriched by the transparent lens that transmits the strong light emitted by the light sources inside the upper metal element.



### **Pieno - Vuoto**

[It] → Si tratta di una lampada composta da un tronco di cono in metallo e un diffusore in PMMA. Il design minimale di questa collezione, contrasta volutamente, col forte effetto illuminante. Ciò è possibile, grazie ad una lente trasparente che veicola il fascio di luce dalle sorgenti luminose all'interno del cappello superiore in metallo.



### **OPTIK**

**S0**  
suspension

**dimensions**  
Ø 60 x H 20 cm

**color**  
black RAL 9005





## **OPTIK**

**S0**  
suspensions

**dimensions**  
Ø 60 x H 20 cm

**colors**  
polished gold  
polished chrome  
black RAL 9005

**SO**

suspension

**dimensions**

Ø 60 x H 20 cm

**color**

polished gold

**OPTIK** collection

design RR44

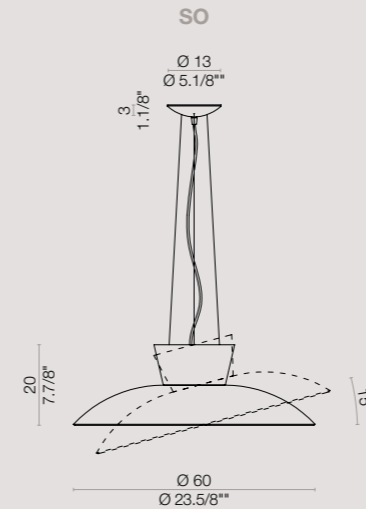

[En] → Suspension lamp with possibility of inclination + or - 15 °. The metal is available in 3 finishes: black, chrome and gold. White ceiling canopy.

[It] → Lampada da sospensione con possibilità di inclinazione di + 0 - 15°. Il metallo è disponibile in 3 finiture: nero, cromo e oro. Rosone a soffitto: bianco.



**colors**

-  polished chrome / cromo lucido
-  polished gold / oro lucido
-  black / nero RAL 9005

**material**

metal and PMMA  
metallo e PMMA

**light source**

**SO 60**  
3 x max 8W LED GU10  
**IMPORTANT: ONLY LED**

**symbols**

**energy label**



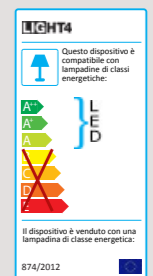

**RING**  
COME  
TRUE

## **RING** collection

[En] → **A continuous circle of light.** The upper and lower diffusers in PMMA are completely without any fixing elements which allows the light emission to be perfectly continuous. This is possible thanks to an innovative construction of the section of the lamp which unites the two sides through an internal metal bracket. The same bracket supports the light source which is integrated in a silicone body allowing the light emission to be completely uniform. The lamp has a double light emission.



### **Un cerchio continuo di luce**

[It] → I diffusori, inferiore e superiore, sono in PMMA opalino. Il flusso luminoso continuo è ottenuto grazie all'assenza di elementi di fissaggio e ad una costruzione innovativa del profilo della lampada che unisce le due pareti in metallo attraverso una staffa anch'essa in metallo. La stessa staffa, poi, sostiene la sorgente luminosa che è inserita in un involucro di silicone. In tal modo si elimina la puntinatura dello strip LED e si ottiene una luce perfettamente uniforme. La lampada ha emissione luminosa sia verso l'alto che verso il basso.





**RING**

**SO 80**  
suspension

**dimensions**  
Ø 80 x H 5 cm

**color**  
white RAL 9010





## **RING**

**SO 80 / SO 120**  
suspensions

**dimensions**  
Ø 80 x H 5 cm  
Ø 120 x H 5 cm

**color**  
brushed bronze



**RING**

SO 80 / SO 120  
suspensions

dimensions  
Ø 80 x H 5 cm  
Ø 120 x H 5 cm

color  
brushed bronze



**RING**

SO 80 / SO 120  
suspensions

dimensions  
Ø 80 x H 5 cm  
Ø 120 x H 5 cm

color  
brushed gold

[En] → **BI-emission lighting.**

The constructive principle of the lamp allows a double light emission. This detail makes the product capable of illuminating the surrounding space with a 360 degrees light. The upper and lower light emission are equal both for what concerns quantity and colour giving a completely homogeneous effect.

**BI-emissione luminosa**

[It] → Il principio costruttivo delle lampade rende possibile una doppia emissione luminosa: in tal modo l'ambiente circostante viene illuminato a 360 gradi. Inoltre, la luce orientata verso l'alto e verso il basso è uguale sia per quantità che per colore al fine di rendere il flusso di luce completamente omogeneo.

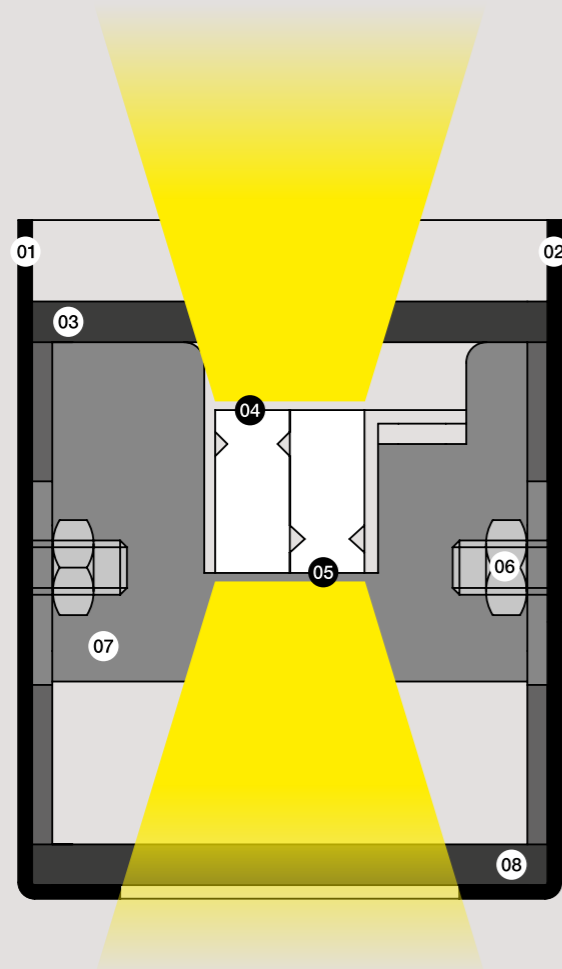

- 01 Metal profile 01.**  
Profilo 01 in metallo.
- 02 Metal profile 02.**  
Profilo 02 in metallo.
- 03 Upper white PMMA diffuser.**  
Diffusore superiore in PMMA bianco.
- 04 Light source - Strip LED.**  
**Light emission UP.**  
Sorgente luminosa - Strip LED.  
Emissione luminosa verso l'alto.
- 05 Light source - Strip LED.**  
**Light emission DOWN.**  
Sorgente luminosa - Strip LED.  
Emissione luminosa verso il basso.
- 06 Mechanical fixing of the metal bracket.**  
Fissaggio meccanico della staffa in metallo.
- 07 Metal bracket: Strip LED support / union of profile 01 & 02.**  
Staffa in metallo: supporto strip LED / unione profilo 01 & profilo 02.
- 08 Lower white PMMA diffuser.**  
Diffusore inferiore in PMMA bianco.

**RING** collection

design L4B

SO 80

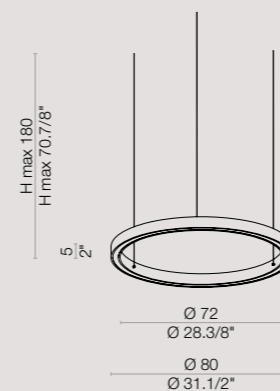

SO 120

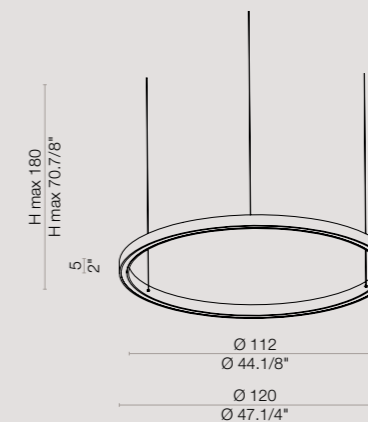

**material**

metal and PMMA  
metallo e PMMA

**light source**

LED 220-240V

120V for  
NORTH AMERICA

**equipment**

**SO 80**  
75W 3000°K Im 2000 UP Im 2000 DOWN

**SO 120**  
115W 3000°K Im 3250 UP Im 3250 DOWN

**symbols**



**colors**

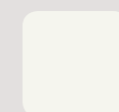

white / bianco  
RAL 9010

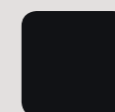

black / nero  
RAL 9005

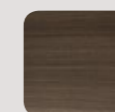

brushed bronze  
/ bronzo spazzolato

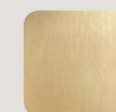

brushed gold  
/ oro spazzolato

**energy label**

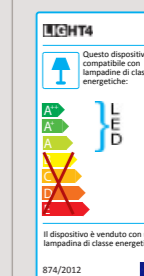

label A





# COLORS AND FABRICS

**FABRICS / AQUA, BRICK, MLAMP SHADES**

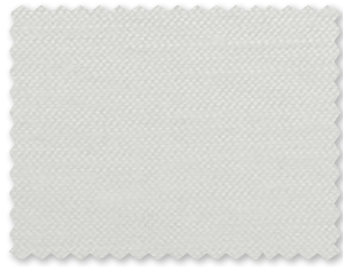

01 white / bianco



02 red / rosso



03 green / verde



04 blue / blu



05 black / nero



06 brown / marrone



07 ivory-cream / avorio-crema



09 tobacco / tabacco



10 cream / crema



12 blue / blu mare



13 light blue / azzurro cielo

**FABRICS / ITASHADES**



66.8003.11 white / bianco



66.8003.82 dove / tortora



66.8003.52 brown / marrone



66.8003.09 bordeaux

**PMMA / MISSTRASS**

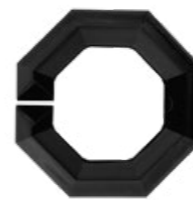

coal



crystal



honey

**METALS / ALULED, FRAME, HOLE, JAM, OPTIK, RING, SAT LIGHT, SOFT LIGHT, STAR LIGHT**



white / bianco  
RAL 9010

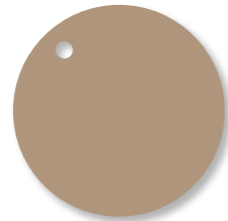

dove / tortora  
RAL 1019

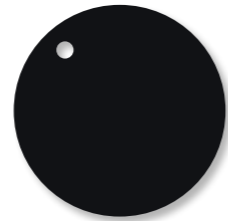

black / nero  
RAL 9005



bronze / bronzo



concrete / cemento



brushed bronze  
/ bronzo spazzolato



brushed nickel  
/ nichel spazzolato



brushed gold  
/ oro spazzolato

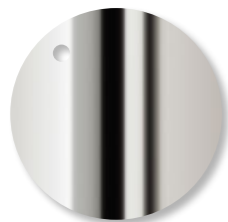

polished chrome  
/ cromo lucido

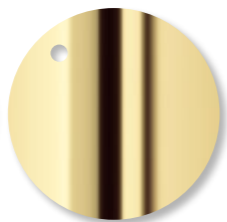

polished gold  
/ oro lucido



matt silver anodised  
/ anodizzato argento opaco



matt gold anodised  
/ anodizzato oro opaco

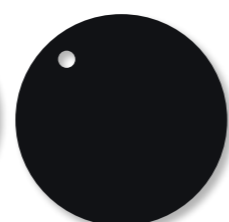

black anodised  
/ nero anodizzato

**METALS / MULTI4**



white / bianco  
RAL 9010

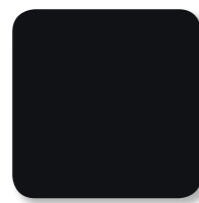

black / nero  
RAL 9005

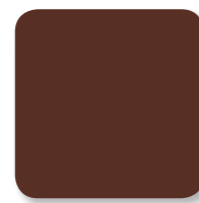

brown / marrone  
RAL 8016



red / rosso  
RAL 3020



grey / grigio  
RAL 9006

**ENERGY LABEL**

**LIGHT4**

Questo dispositivo è compatibile con lampadine di classi energetiche:

Il dispositivo è venduto con una lampadina di classe energetica:

874/2012

label A

**aluled** p. 22

**aqua** p. 50

**brick** p. 66

**candy** p. 78

**drop** p. 84

**frame** p. 94

**hole** p. 12

**io** p. 118

**itashades** p. 126

**jam** p. 136

**misstrass** p. 150

**mlampshades** p. 164

**multi4** p. 178

**optik** p. 186

**ring** p. 194

**sat light** p. 16

**soft light** p. 18

**star light** p. 20

**LIGHT4**

Questo dispositivo è compatibile con lampadine di classi energetiche:

Il dispositivo è venduto con una lampadina di classe energetica:

874/2012

label B

**jam sphere** p. 136

itama by

**LIGHT4**

LIGHT4 srl viale dell'industria, 2A - 31055 quinto di treviso (tv) - italia  
t. +39 0422 378122 - t. +39 0422 475009 - f +39 0422 370409  
www.itamaluce.com - www.light4.it - info@light4.it

[www.light4.it](http://www.light4.it)