

LIGHT4

L I G H T & L I V I N G



choose & TURN



scegli & AVVITA

CHOOSE

CHOOSE THE DIFFUSER: hand made glass diffusers obtained with different processes, in different shapes and colors.

CHOOSE THE STRUCTURE: aluminum frames liquid finish in different colors. Available in suspension, wall, ceiling, table, bedside table and floor versions.

SCEGLI

SCEGLI IL DIFFUSORE: *diffusori in vetro realizzati con diverse lavorazioni, in differenti forme e colori.*

SCEGLI LA STRUTTURA: *montature in alluminio con finitura a liquido in diversi colori. Disponibili nelle versioni da sospensione, parete, soffitto, tavolo, comodino e terra.*

FINALLY, *with* a simple ACTION

E poi con un semplice gesto



TURN your LAMP

Avvita la tua lampada



choose & TURN



scegli & AVVITA





the **ARTISAN TRADITION** meets **innovation**

La tradizione artigianale incontra l'innovazione

The "Choose and Turn" project proposes lamps collections of different designs, which can be coordinated and interchanged thanks to a screw fastening system, specially designed to make the connection between structure and diffuser, easier.

The natural elegance of glass merges in this way, by an innovative system, with the essentiality of the brushed metal structures in bright and captivating colors, leaving full freedom in the creation of your own lamp, with multiple combinations.

All the parts in the catalogue, lend to modularity with the same model or hybrid combining different diffusers.

Il progetto "Scegli e Avvita" propone collezioni di lampade di diverso design, coordinabili e intercambiabili grazie a un sistema di aggancio a vite, studiato appositamente per rendere semplice l'attacco tra struttura e diffusore.

L'eleganza naturale del vetro si fonde così, in maniera innovativa, con l'essentialità delle strutture in metallo spazzolato dai colori luminosi e accattivanti lasciando piena libertà nel realizzare la propria lampada in molteplici abbinamenti e combinazioni.

Un sistema di vetri, nella tipica tendenza Vintage di Light4, che si presta alla modularità, alle combinazioni e agli abbinamenti di tutte le collezioni.

GLACE
12



ALBA
20



CANOVA
30



ROSÉE
38



BALL
50



BALL MINI
60







Bedside lamp

Strike glass with brushed burnished structure
Wave glass with black structure

Lampada da comodino

Strike vetro con montatura brunito spazzolato
Wave vetro con montatura nera

GLACE

design | LAB



In the middle of winter, I finally learned that there was in me an **invincible summer.**

Nel bel mezzo dell'inverno, ho infine compreso che vi era in me un **invincibile estate.**

- Albert Camus -

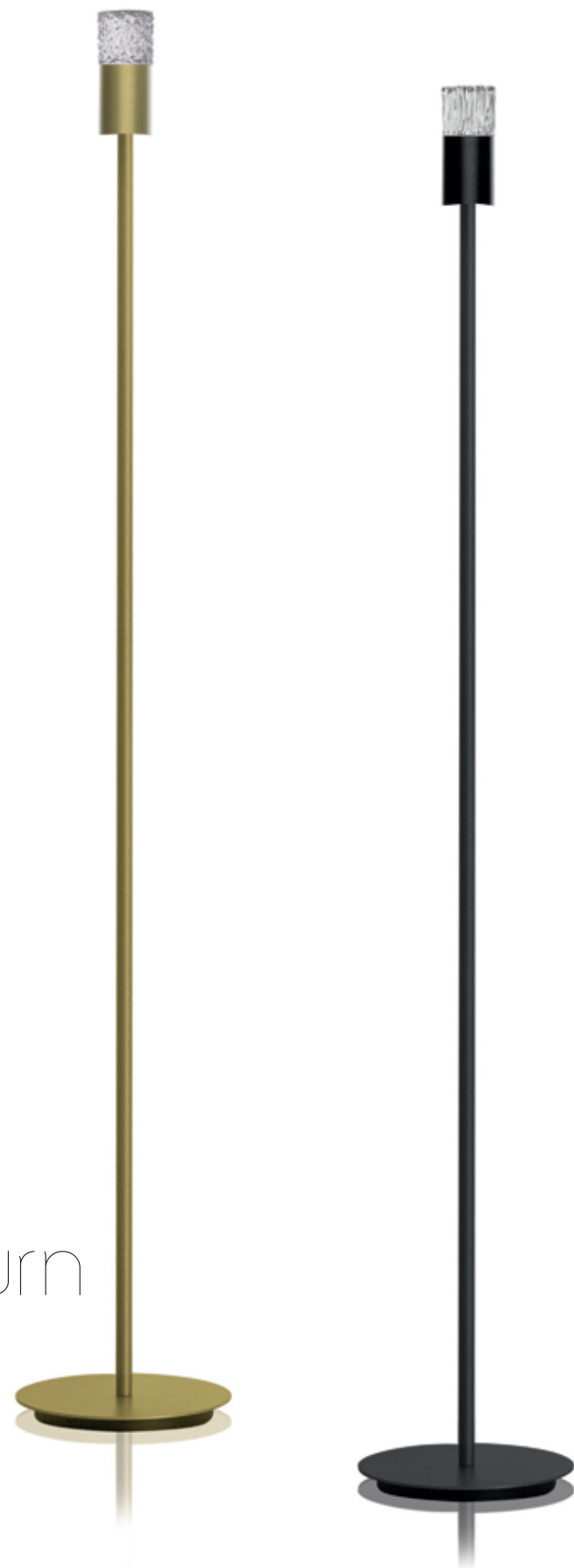

choose & turn



Suspension lamp
 Strike glass with brushed gold structure
 Wave glass with brushed gold structure

Lampada da sospensione
Strike vetro con montatura oro spazzolato
Wave vetro con montatura oro spazzolato



Cold and bright like a fragment of ice, the GLACE diffuser is made of transparent cast glass hand engraved, piece by piece. Available in two designs.

Algido e brillante come un frammento di ghiaccio, il diffusore GLACE è realizzato in vetro colato trasparente inciso a mano pezzo per pezzo. Disponibile in due motivi.

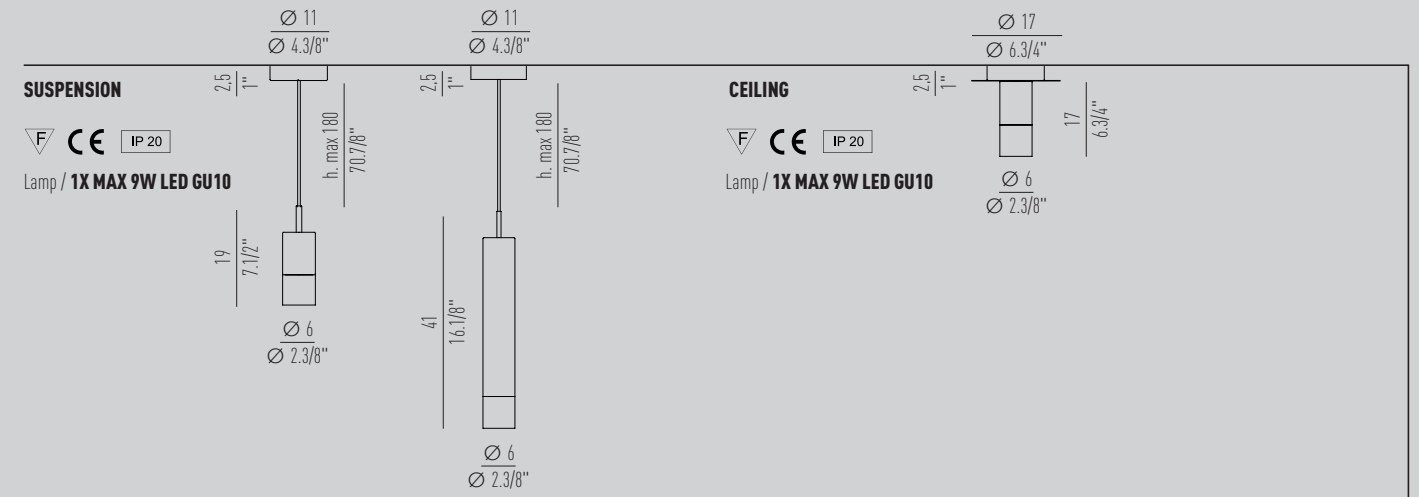

GLACE

collection

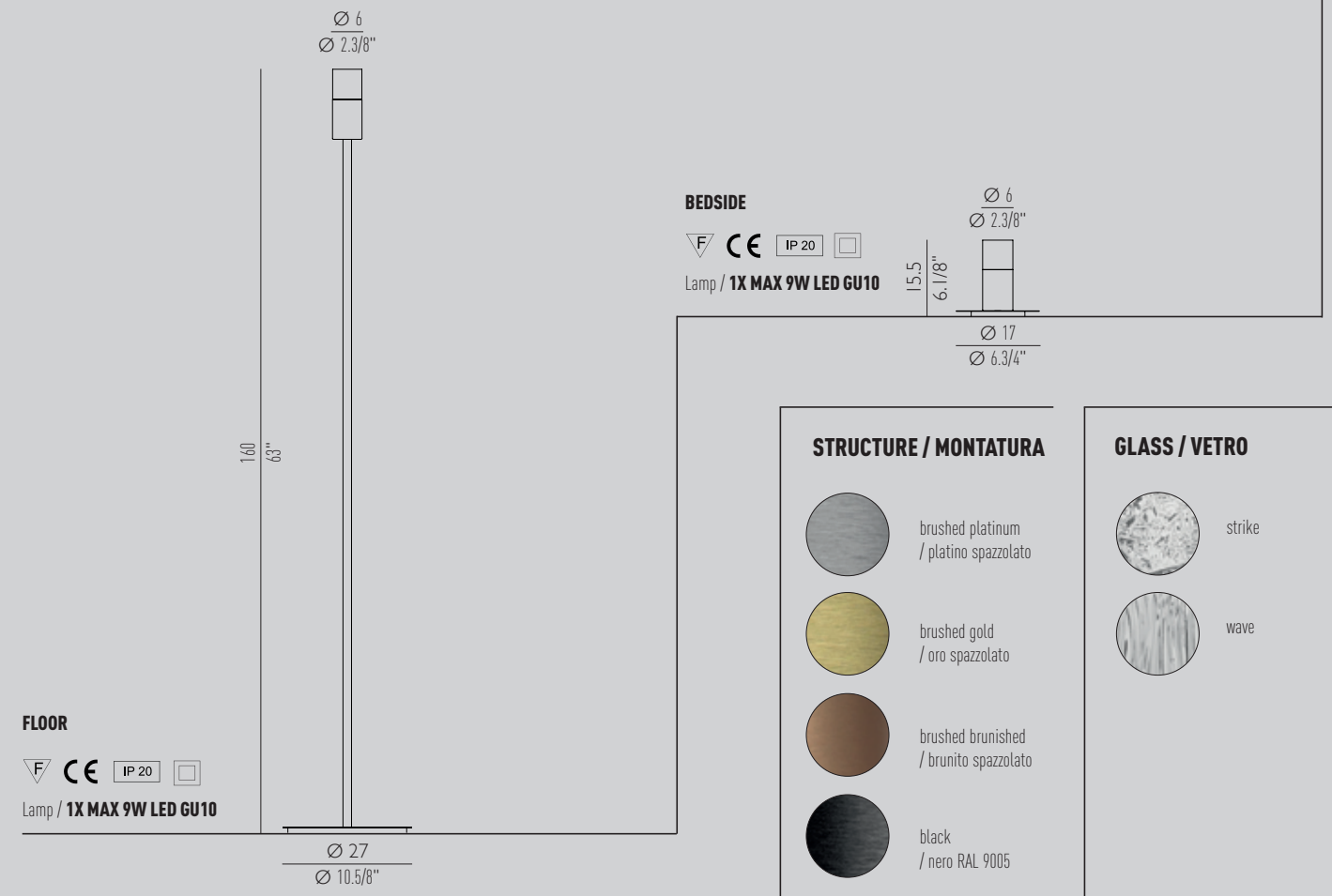



ALBA
design | Giovanni Barbato





ALBA
design | Giovanni Barbato

Since the dawn is **growing**, since here is the **sunrise**.
Poiché l'alba si accende, ed ecco l'aurora.

- Paul Verlaine -



Suspension lamp

Glass BIG smoky grey, white & amber with brushed gold structure

Lampada da sospensione

Vetro BIG fumè, bianco e ambra con montatura oro spazzolato

Suspension lamp

Glass SMALL smoky grey, white & amber with black structure



Lampada da sospensione

Vetro SMALL fumè, bianco e ambra con montatura nera

choose & turn



Bedside lamp

Glass BIG amber with black structure

Glass SMALL smoky grey with brushed gold structure



*Lampada da comodino
 vetro BIG ambra con montatura nera
 vetro SMALL fumè con montatura oro spazzolato*



Elegant and precious, the diffusers of the ALBA collection are made of transparent blown glass, with a tone-on-tone white layered shade. Available in two shapes and three colors: clear, amber and smoky grey.

Eleganti e pregiati, i diffusori della collezione ALBA sono realizzati in vetro soffiato trasparente, con sfumatura incamiciata bianca tono su tono. Disponibile in due forme e tre colori: trasparente, ambra e fumé.

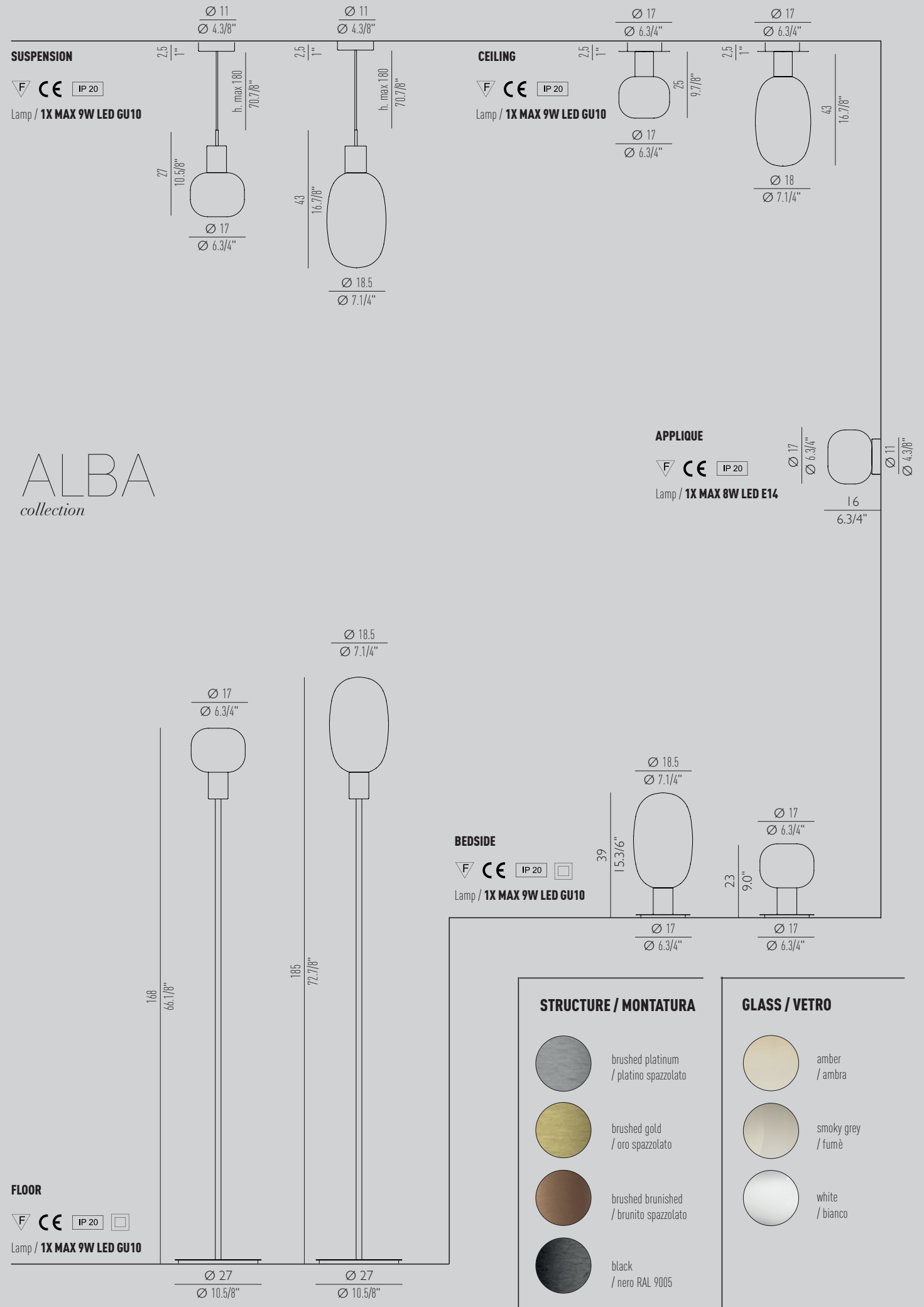

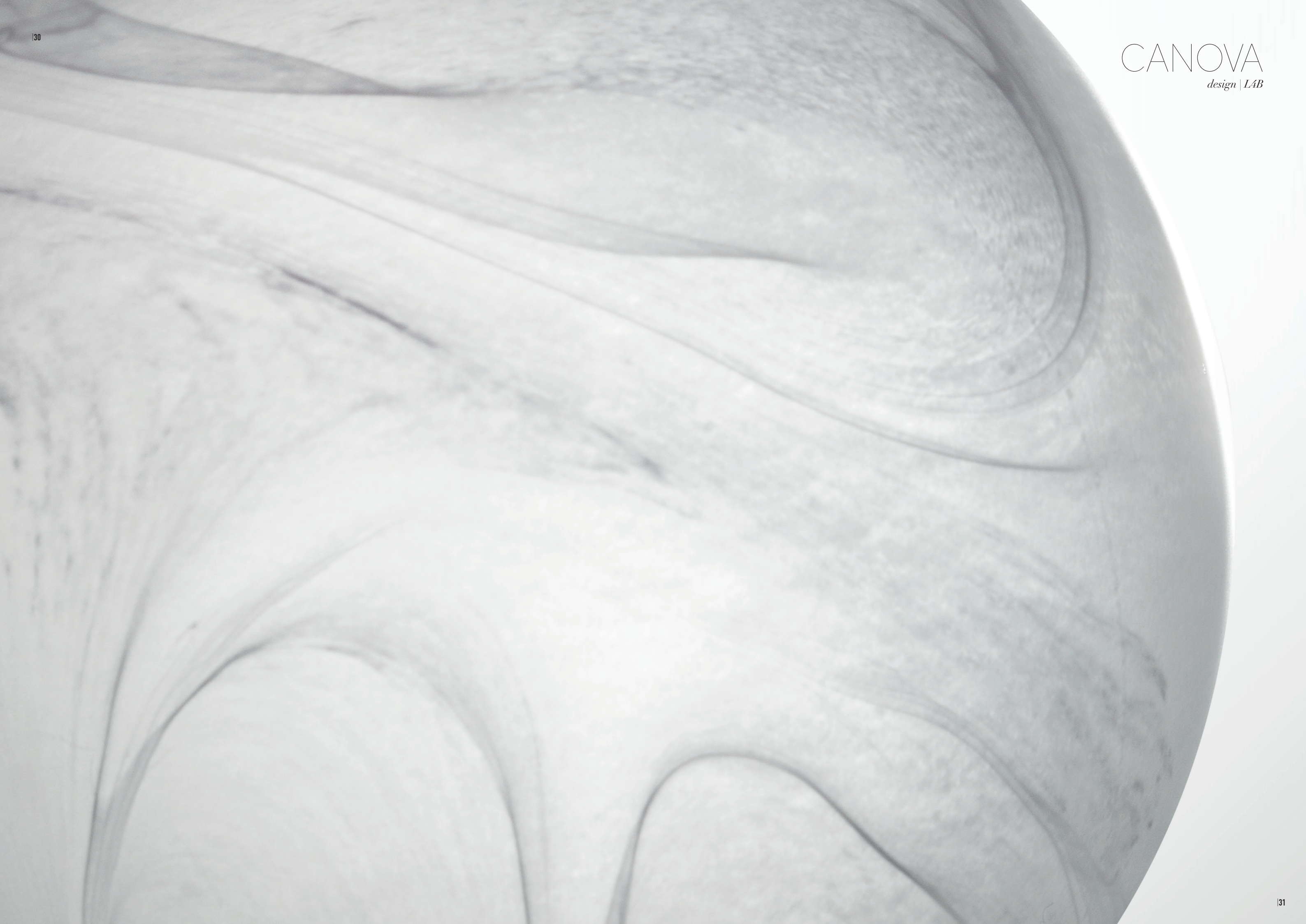



Suspension lamp / lampada da sospensione

Glass MARBLE effect e WHITE with brushed platinum, burnished, gold or black structure /
vetro effetto MARMO e BIANCO con montatura platino, brunito, oro spazzolato o nero

What makes me most impatient is to see the effect the **work** will have on the **soul of the audience**.

Ciò che mi rende più impaziente è vedere l'effetto che l'opera produrrà sulle anime del pubblico.

- Antonio Canova -



choose & turn



Bedside lamp
 Glass WHITE with black structure
 Glass MARBLE effect with brushed gold structure

Lampada da comodino
vetro BIANCO con montatura nera
vetro effetto MARMO con montatura oro spazzolato



The sphere, is the most classic shape, in the CANOVA collection, blown glass, available in the milky white satin finish variant and the new marble effect, satin finish grey veins on a white base.

La sfera, forma classica per eccellenza, per la collezione CANOVA, vetro soffiato, disponibile nella variante biancolatte incamiciato satinato e nella variante effetto marmo su fondo bianco satinato, screziato da venature grigie.

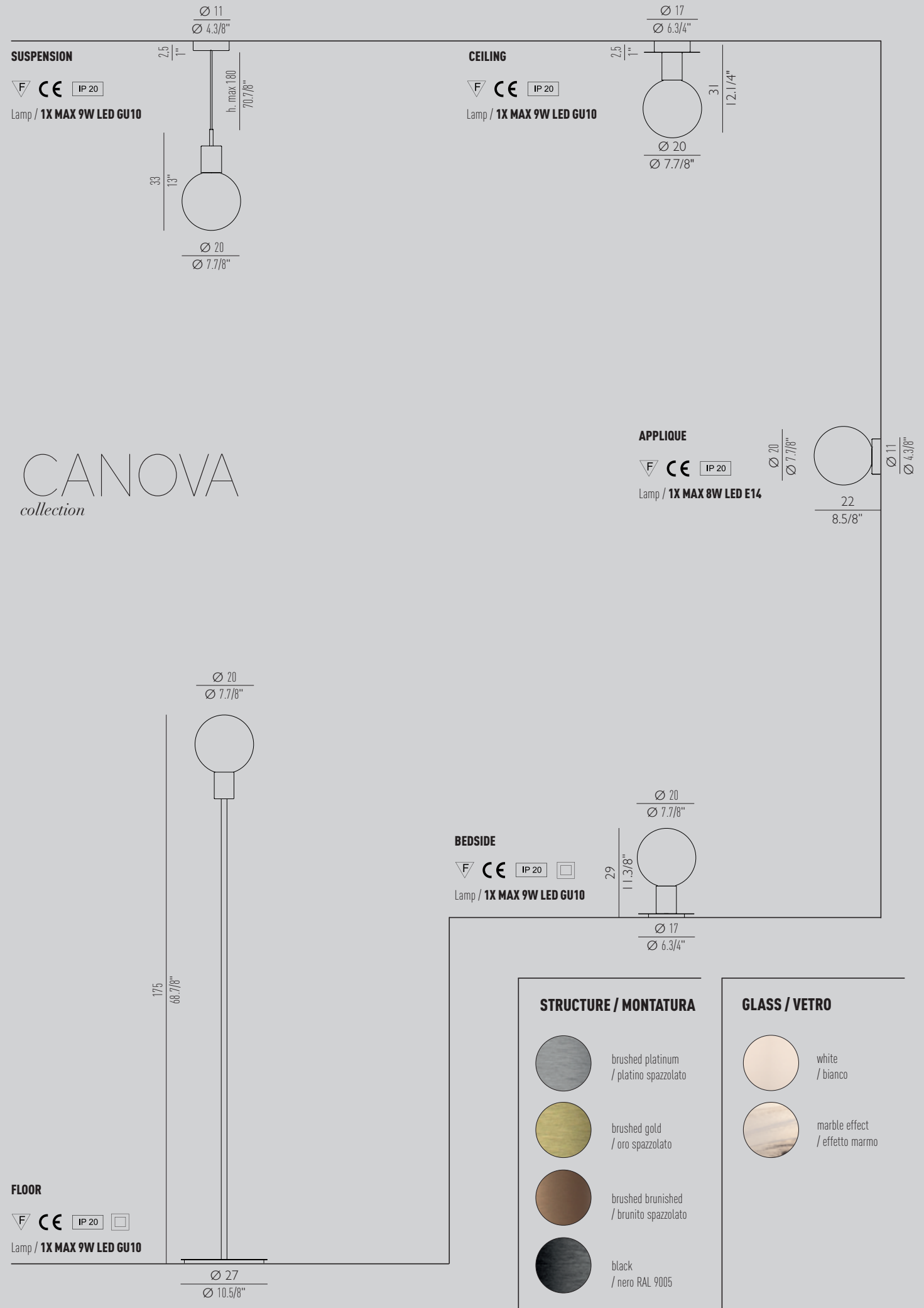



ROSEÉ
design LAB



I must go **seek dewdrops** here.
And hang a pearl in every **cowslip's** ear.

*Debbo andare a cercare gocce di
rugiada. E appendere una perla
all'orecchio di ogni primula.*

- William Shakespeare -

Rosée 2L

glass BIG clear with brushed platinum structure, glass MEDIUM smoky grey, glass SMALL chrome



*Rosée 2L
vetro BIG trasparente con montatura platino spazzolato, vetro MEDIUM fumè, vetro SMALL cromo*

**Rosée 2L x 3**

glass BIG clear & amber with brushed gold structure, glass MEDIUM clear & amber, glass SMALL gold

Rosée 2L

vetro BIG trasparente & ambra con montatura oro spazzolato, vetro MEDIUM trasparente & ambra, vetro SMALL oro



Custom project by WeDoDesigns / Progetto speciale di WeDoDesigns

choose & turn

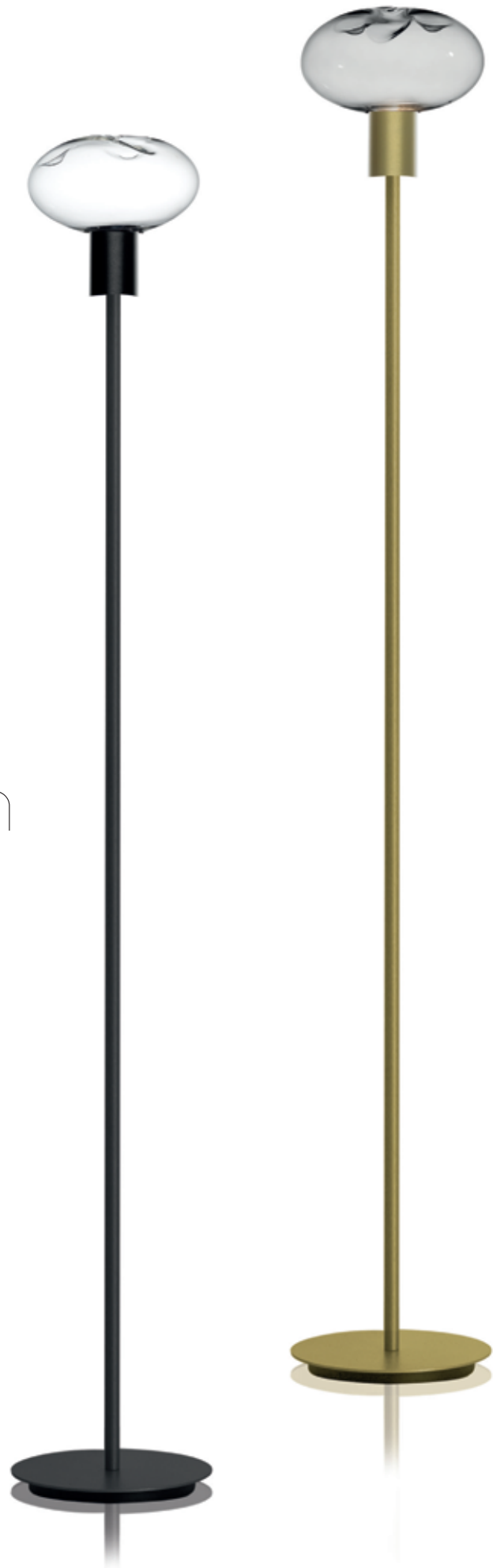

Bedside lamp
 Glass BIG clear with black structure
 Glass MEDIUM amber with brushed gold structure

Lampada da comodino
vetro BIG cristallo con montatura nera
vetro MEDIUM ambra con montatura oro spazzolato



Evocano la forma di gocce di rugiada i vetri della collezione ROSEE, diffusori ed elementi decorativi in vetro borosilicato, ideali per realizzare fantastiche composizioni.

Diffusori disponibili in due dimensioni, diam 17 e 20 cm, e tre colori: trasparente o ambra e fumé con decorazione "lustrò", antica tecnica che dona al vetro un riflesso iridescente.

Il vetro decorativo diam 14 cm è disponibile in finitura metallizzata oro o cromo.

The glass shapes of the ROSEE collection remind of dew drops. Diffusers and decorative elements are in borosilicate glass, ideal for creating fantastic compositions.

Glass available in two sizes, diam. 17 and 20 cm, and in three colors, clear or amber and smoky grey with luster decoration. "lustrò", an ancient technique that gives the glass an iridescent reflection.

The decorative glass diam. 14 cm, is in metallized gold or chrome finish.

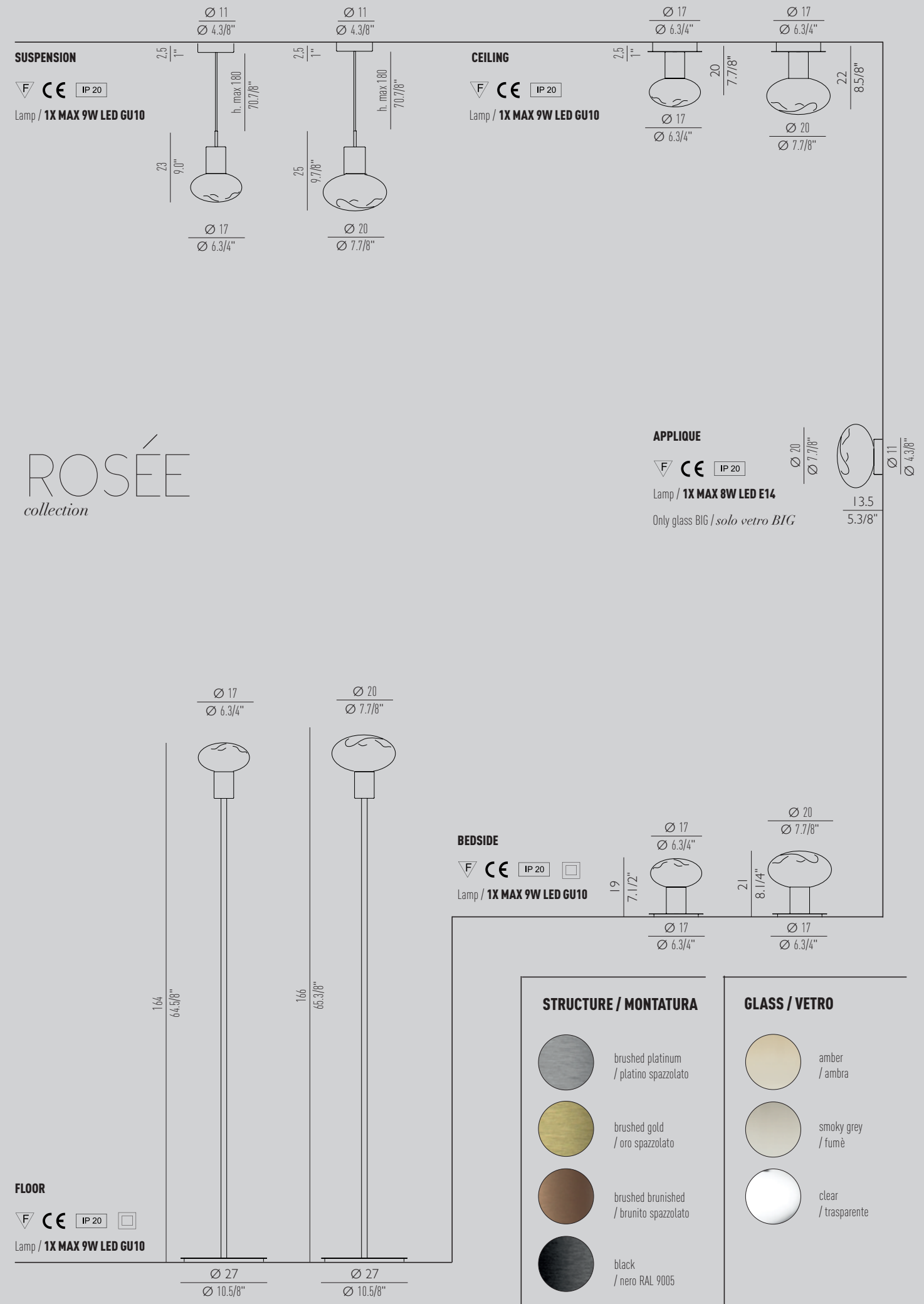





Custom installation 9L
 installazione speciale 9L

BALL
 design | Brian Rasmussen



Keep your face always **toward the sunshine**
 and **shadows** will fall **behind you.**

*Tieni il viso rivolto sempre verso il sole
 e le ombre cadranno dietro di te.*

- Walt Whitman -

OGNI LAVORAZIONE **CREA** IL SUO **effetto luminoso**

each technique creates its own luminous effect

Il vetro della collezione BALL è soffiato a bocca da esperti maestri vetrai. Ogni vetro è unico ed è 100% made in Italy.

The glass diffuser of the BALL collection is blown by expert glass masters. Each glass is unique; each glass is 100% Made in Italy.



BALLOTON

Technique used to obtain a particular optical effect. It is based on the use of a metal die, with the inner walls containing small square based pyramidal "spikes" which, when the glass is blown, result in a cross-relief pattern.

Tecnica usata per ottenere un particolare effetto ottico. Si basa sull'uso di uno stampo in metallo contenente all'interno delle punte a piccola piramide a base quadrata che, nella soffiatura, danno un effetto di rilievo incrociato.



RIGADIN

Thin ribbing obtained by blowing a glass object inside an open die, generally in bronze, which has grooves with a triangular cross-section.

Decoro ottenuto soffiando la pallina in uno stampo, in genere di bronzo, che porta delle scanalature a sezione triangolare. La pèa diventa costolata.



RIGADIN RITORTO

The piece thus becomes ribbed and can also be twisted inside the mold to produce rigadin ritorto (swirl or twisted ribbing).

Se il vetro viene anche ritorto durante la stampigliatura si ottiene il rigadin ritorto.



BULLICANTE

By casing a gather (pèa) stamped in this way in a layer (coperta) of glass, an effect is obtained whereby hundreds of minute air bubbles are trapped between two layers of glass.

Ricoprendo una pèa, stampata a balloton, con una coperta si ottiene l'effetto bullicante o a bolle, consistente in una miriade di piccolissime bolle d'aria rimaste intrappolate tra i due strati di vetro.



choose & turn

Wall sconce applique
Glass BALLOTON clear with brushed burnished structure

Applique
vetro BALLOTON cristallo con montatura oro spazzolato

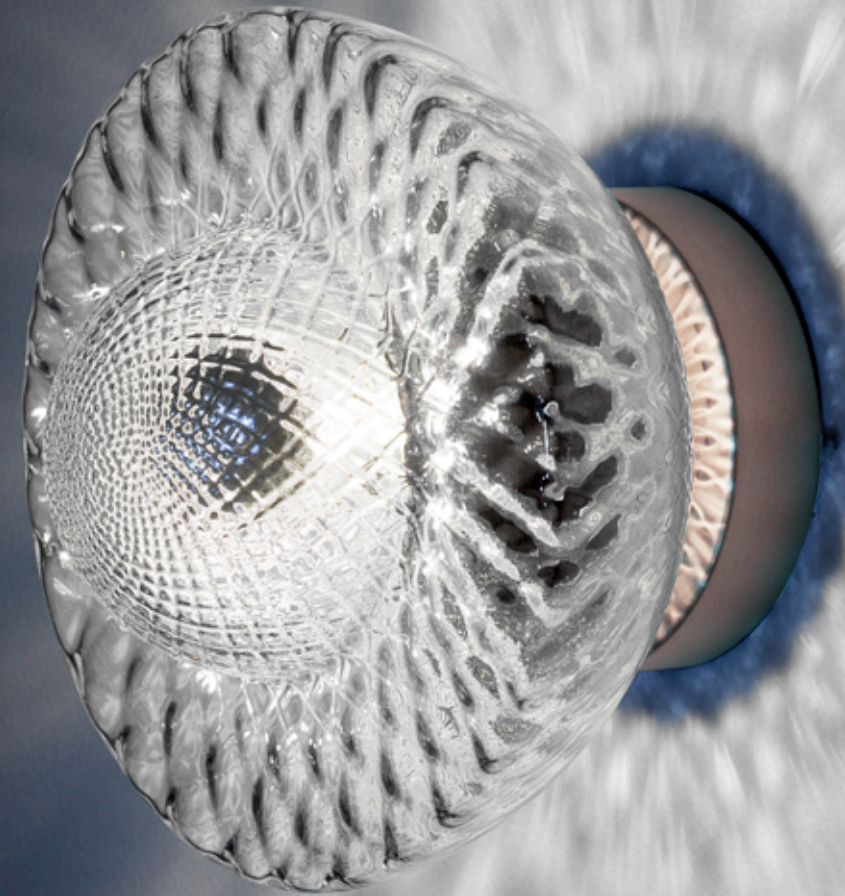



Use of traditional manufacturing techniques for the diffusers of BALL collection; made of transparent blown glass and glossy milky white, when enlightened, they develop particular effects of light and shadows on the walls.

Impiego di tradizionali tecniche di lavorazione per i diffusori della collezione BALL; realizzati in vetro soffiato trasparente e biancolatte lucido, quando illuminati creano sulle pareti particolari giochi di luci e ombre.

SUSPENSION

Lamp / 1X MAX 9W LED GU10

Dimensions: $\varnothing 11$ / $\varnothing 4.3/8''$, 2.5 / $1''$, $h. max. 180$ / $70.7/8''$, 27 / $10.5/8''$, $\varnothing 20$ / $\varnothing 7.7/8''$

CEILING

Lamp / 1X MAX 9W LED GU10

Dimensions: $\varnothing 17$ / $\varnothing 6.3/4''$, 2.5 / $1''$, 25 / $9.7/8''$, $\varnothing 20$ / $\varnothing 7.7/8''$

BALL
collection

FLOOR

Lamp / 1X MAX 9W LED GU10

Dimensions: $\varnothing 20$ / $\varnothing 7.7/8''$, 1.68 / $6.6.1/8''$, $\varnothing 27$ / $\varnothing 10.5/8''$

APPLIQUE

Lamp / 1X MAX 8W LED E14

Dimensions: $\varnothing 20$ / $\varnothing 7.7/8''$, 16.5 / $6.1/2''$, $\varnothing 11$ / $\varnothing 4.3/8''$

BEDSIDE

Lamp / 1X MAX 9W LED GU10

Dimensions: $\varnothing 20$ / $\varnothing 7.7/8''$, 23 / $9.0''$, $\varnothing 17$ / $\varnothing 6.3/4''$

STRUCTURE / MONTATURA		GLASS / VETRO	
	brushed platinum / platino spazzolato		white / bianco
	brushed gold / oro spazzolato		clear / trasparente
	brushed brunished / brunito spazzolato		
	black / nero RAL 9005		



You need to let the **little things** that would ordinarily bore you suddenly **thrill you**.

Lascia che le piccole cose che normalmente ti annoiano, ti emozionino all'improvviso.

- Andy Warhol -



Bedside lamp

Glass BALLOTON clear with brushed gold structur

Lampada da comodino

vetro BALLOTON cristallo con montatura oro spazzolato

BALL MINI

design | Brian Rasmussen

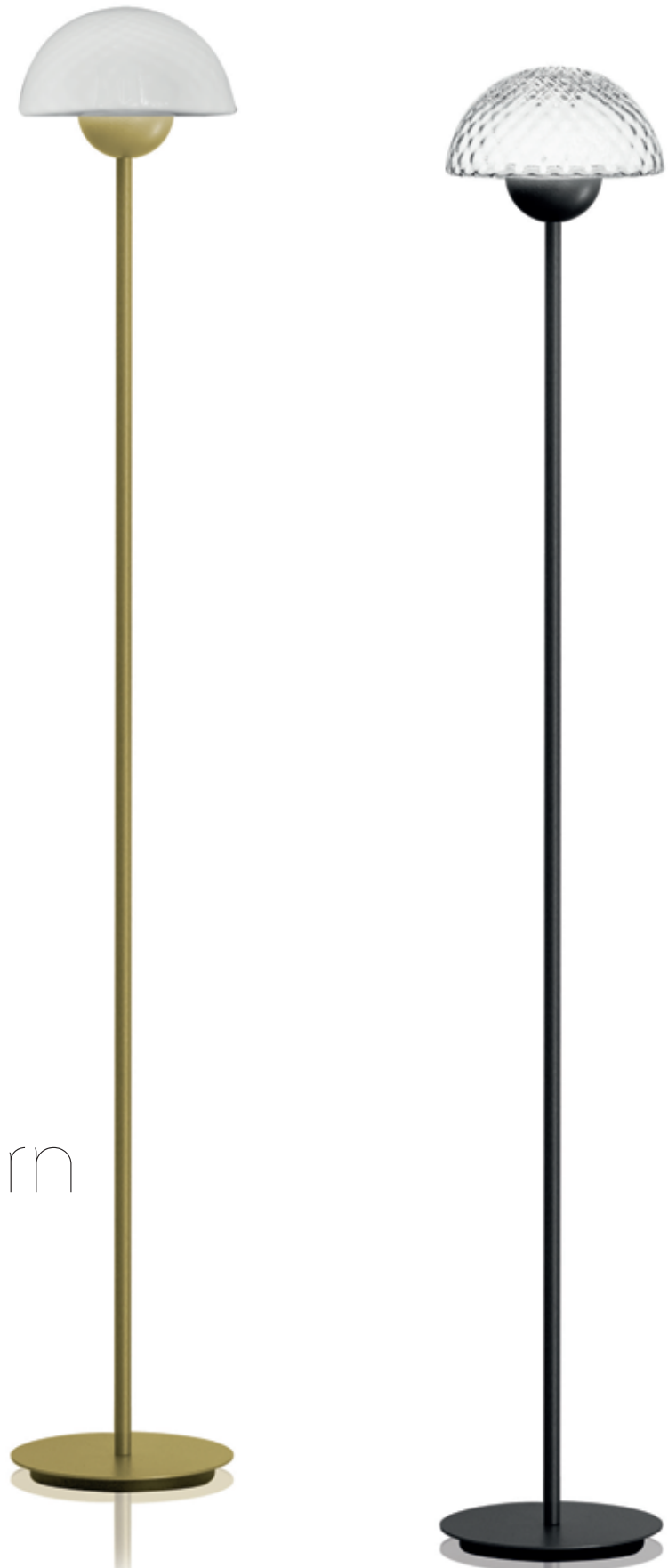

choose & turn



Table lamp
Glass BALLOTON white with brushed gold structure

Lampada da tavolo
vetro BALLOTON clear con montatura oro spazzolato



Use of traditional manufacturing techniques for the diffusers of BALL collection; made of transparent blown glass and glossy milky white, when enlightened, they develop particular effects of light and shadows on the walls.

Impiego di tradizionali tecniche di lavorazione per i diffusori della collezione BALL; realizzati in vetro soffiato trasparente e biancolatte lucido, quando illuminati creano sulle pareti particolari giochi di luci e ombre.

SUSPENSION

⚡ CE IP 20

Lamp / 1X MAX 9W LED GU10

CEILING

⚡ CE IP 20

Lamp / 1X MAX 9W LED E14

BALL MINI

collection

FLOOR

⚡ CE IP 20

Lamp / 1X MAX 9W LED GU10

APPLIQUE

⚡ CE IP 20

Lamp / 1X MAX 8W LED E14

BEDSIDE

⚡ CE IP 20

Lamp / 1X MAX 9W LED GU10

TABLE

⚡ CE IP 20

Lamp / 1X MAX 8W LED E14

STRUCTURE / MONTATURA

- brushed platinum / platino spazzolato
- brushed gold / oro spazzolato
- brushed brunished / brunito spazzolato
- black / nero RAL 9005

GLASS / VETRO

- white / bianco
- clear / trasparente

GLACE

CANOVA

ALBA

ROSÉE

BALL

BALL MINI



DIFFUSER LAMP

diffusori in vetro

GLACE

design | LAB



STRIKE



WAVE

BIG



WHITE
Bianco



SMOKY GREY
Fumè



AMBER
Ambra

SMALL



WHITE
Bianco



SMOKY GREY
Fumè



AMBER
Ambra



MARBLE EFFECT
Effetto marmo



WHITE
Bianco

CANOVA

design | LAB

CHOOSE and turn

scegli e avvita

ROSÉE

design | LAB

BIG



CLEAR
Trasparente



SMOKY GREY
Fumè



AMBER
Ambra

MEDIUM



CLEAR
Trasparente



SMOKY GREY
Fumè



AMBER
Ambra

SMALL



CHROME
Cromo



GOLD
Oro

BALL

design | Brian Rasmussen



CLEAR
Trasparente



WHITE
Bianco

BALL MINI

design | Brian Rasmussen



CLEAR
Trasparente



WHITE
Bianco

STRUCTURE

montature

BEDSIDE GU10

*for_ Glace
Alba
Canova
Rosée
Ball
Ball Mini*



BRUSHED GOLD
Oro spazzolato



BRUSHED BURNISHED
Brunito spazzolato



BRUSHED PLATINUM
Platino spazzolato



BLACK RAL 9005
Nero Ral 9005



BRUSHED GOLD
Oro spazzolato



BRUSHED BURNISHED
Brunito spazzolato



BRUSHED PLATINUM
Platino spazzolato



BLACK RAL 9005
Nero Ral 9005

TABLE E14

for_ Ball Mini

CEILING GU10

*for_ Glace
Alba
Canova
Rosée
Ball
Ball Mini*



BRUSHED GOLD
Oro spazzolato



BRUSHED BURNISHED
Brunito spazzolato



BRUSHED PLATINUM
Platino spazzolato



BLACK RAL 9005
Nero Ral 9005

APPLIQUE E14

*for_ Alba SMALL
Canova
Rosée - BIG
Ball
Ball Mini*



BRUSHED GOLD
Oro spazzolato



BRUSHED BURNISHED
Brunito spazzolato



BRUSHED PLATINUM
Platino spazzolato



BLACK RAL 9005
Nero Ral 9005

FLOOR GU10

*for_ Glace
Alba
Canova
Rosée
Ball*



BRUSHED GOLD
Oro spazzolato



BRUSHED BURNISHED
Brunito spazzolato



BRUSHED PLATINUM
Platino spazzolato



BLACK RAL 9005
Nero Ral 9005

FLOOR E14

for_ Ball Mini



BRUSHED GOLD
Oro spazzolato



BRUSHED BURNISHED
Brunito spazzolato



BRUSHED PLATINUM
Platino spazzolato



BLACK RAL 9005
Nero Ral 9005

STRUCTURE

montature

SUSPENSION
white canopy / rosone bianco

for_ Glace
Alba
Canova
Rosée
Ball
Ball Mini

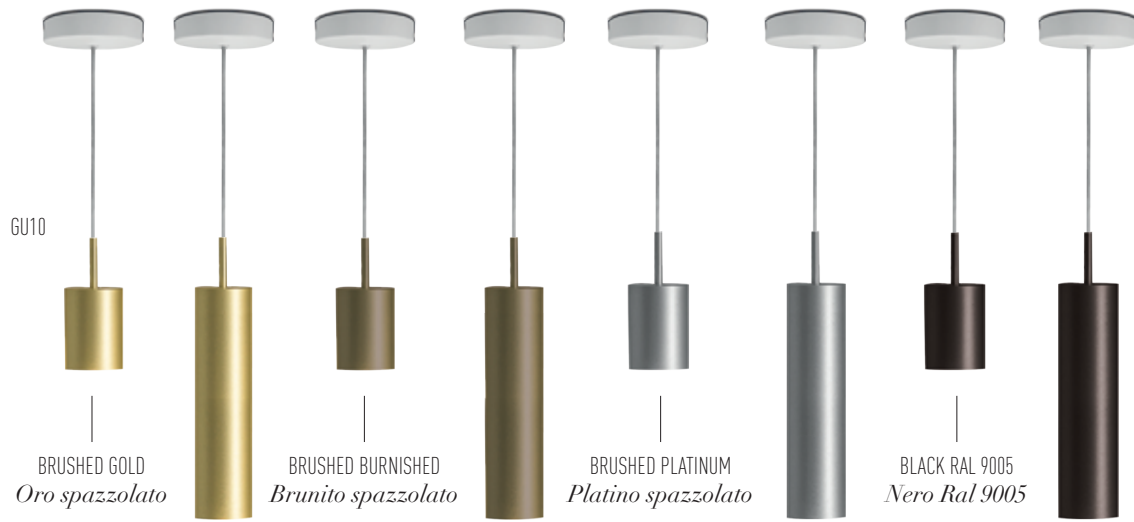

SUSPENSION
colored canopy / rosone in tinta

for_ Glace
Alba
Canova
Rosée
Ball
Ball Mini

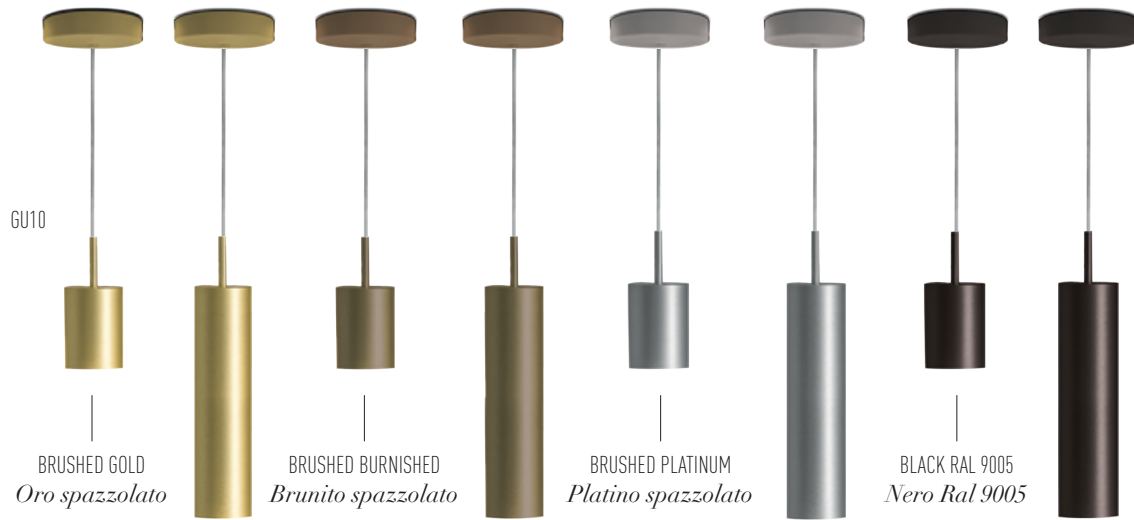

SUSPENSION
without canopy for composition / senza rosone per composizioni

for_ Glace
Alba
Canova
Rosée
Ball
Ball Mini

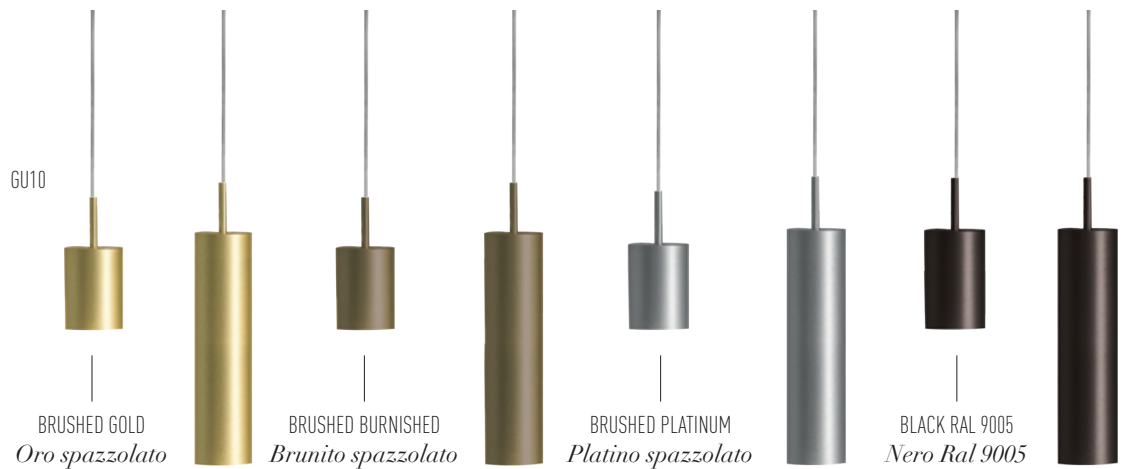

CANOPIES

rosoni

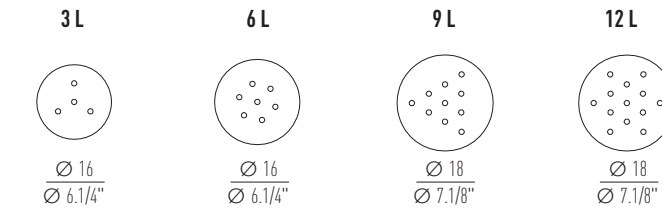

Canopies for compositions /
rosoni per composizioni

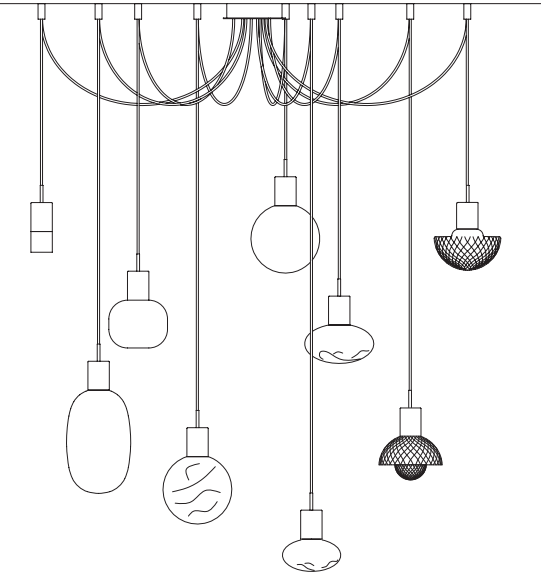

Canopies for multiple suspensions /
rosoni per sospensioni multiple

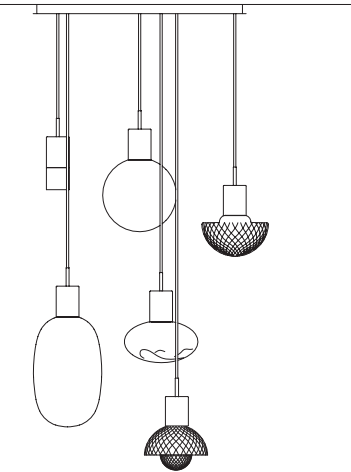
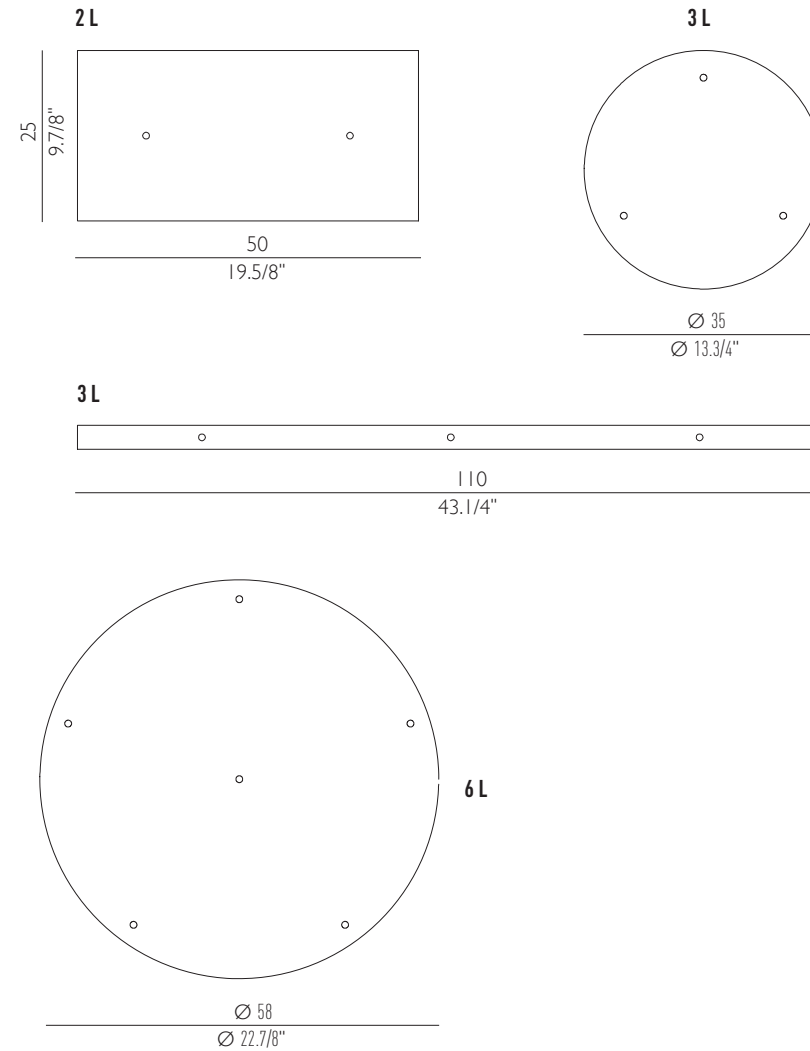

Canopies white RAL 9010 / rosone bianchi RAL 9010

All canopies are available colored on request / tutti i rosone sono disponibili in tinta su richiesta

LIGHT4

L I G H T & L I V I N G

LIGHT4 srl viale dell'industria, 2A - 31055 quinto di treviso (tv) - italia
t. +39 0422 378122 - t. +39 0422 475009 - f +39 0422 370409

www.light4.it - info@light4.it