

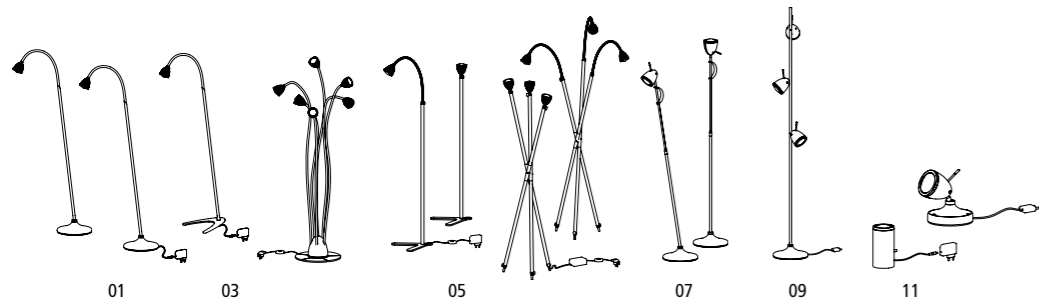

PREISLISTE

INHALT CONTENT



STANDLEUCHTEN FLOOR LIGHTS

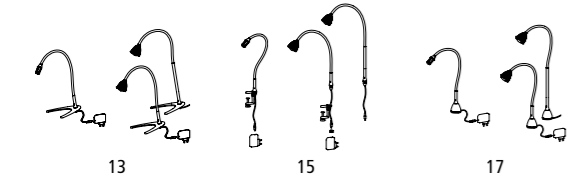

TISCHLEUCHTEN TABLE LIGHTS

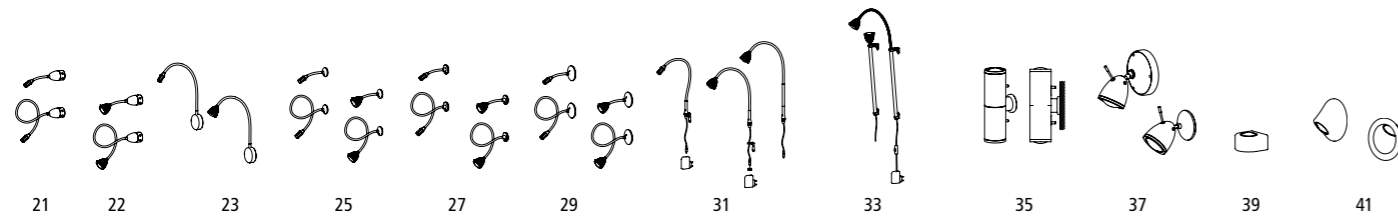

WANDLEUCHTEN WALL LIGHTS

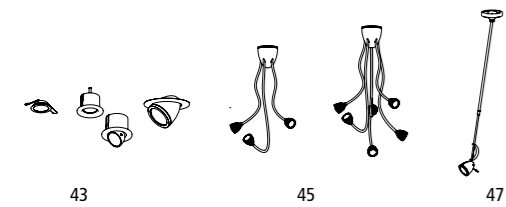

DECKENLEUCHTEN CEILING LIGHTS

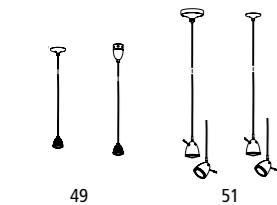

PENDELLEUCHTEN PENDANT LIGHTS

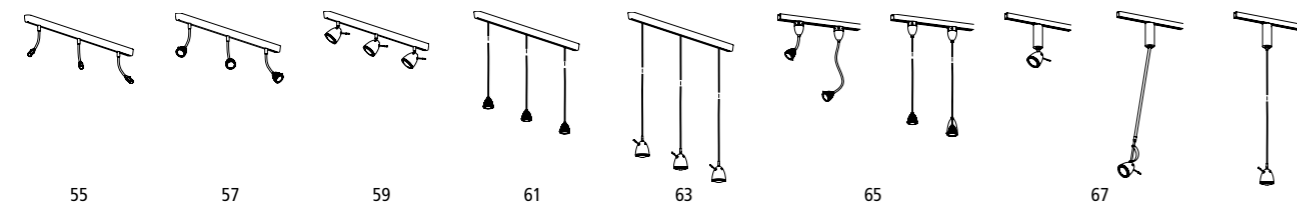

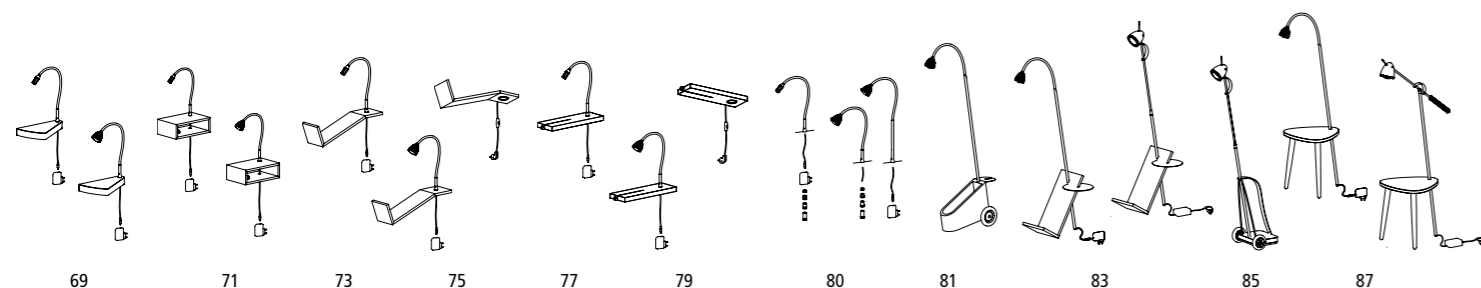

SCHIENENLEUCHTEN RAIL LIGHTS



LICHTMÖBEL FURNITURE LIGHTS

SYMBOLE SYMBOLS

-  LED wechselbar
LED changeable
-  Leuchte dimmbar
light dimmable
-  Leuchte fokussierbar
light focusable
-  Spannung (Volt)
voltage (volt)
-  Lichtstrom (Lumen)
luminous flux (lumen)
-  Farbtemperatur (Kelvin)
color temperature (kelvin)
-  Dim to warm (auf Anfrage)
dim to warm (on demand)
-  Farbwiedergabeindex
color rendering index
-  Schutzart
protection class
-  Systemleistung (Watt)
system power (watt)
-  Speditionsleuchte (extra Kosten beachten)
forwarding light (consider additional costs)
-  Akkuleuchte
accumulator light
-  Neuer Artikel
new article
-  Energieeffizienz
efficiency class

Designpreise Design Awards



reddot design award
winner 2010



DESIGN PLUS



A-ABSL



Typ

Mobile Akku Standleuchte mit Leuchtkopf und Rohr aus massivem Aluminium /// 25–100° stufenlos einstellbarer Abstrahlwinkel durch Glaslinsenoptik /// robuste Flexwelle mit gebürsteter Aluminiumoberfläche oder farbigem Textilüberzug /// Standfuß aus poliertem Beton /// wechselbarer Li-Ionen Akkupack im Sockel /// Leuchtdauer Akku > 6 Std.

Dimmung

Tastdimmer am Rohr

Abmessung

Höhe max. 150 cm / Flexwelle 45 cm / Kopf Ø 6,5 cm / Standfuß Ø 23 cm

Lieferung

inkl. Steckerladegerät, Akku

type

mobile rechargeable floor light with lamp head and tube made of solid aluminium /// glass lens optics with 25–100° infinitely focusable angle beam /// strong flexible shaft in brushed aluminium or colored textile coating /// standing in polished concrete /// exchangeable lithium-ion rechargeable pack inside standing /// operation time > 6 hrs.

dimming

tube dimmer switch

dimension

height max. 150 cm / flex 45 cm / head Ø 6,5 cm / standing Ø 23 cm

delivery

incl. plug charger, rechargeable battery pack

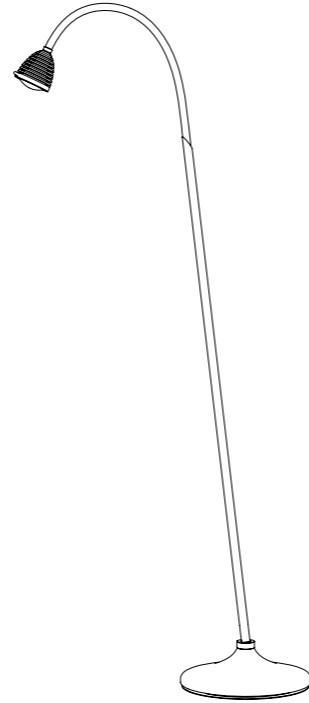

| | | EUR | +19% |
|------------------------|---|--------|---------------|
| A-ABSL | | 630,25 | 750,00 |
| -KA | Kopf und Rohr in Alu head and tube in alu | | |
| -KS | Kopf und Rohr in schwarz head and tube in black | +42,02 | +50,00 |
| -FA | Flexwelle mit gebürsteter Aluminiumoberfläche flexible shaft in alu brush-finished | | |
| -FT... | Flexwelle Textil S = schwarz R = rot A = anthrazit W = weiß G = grün U = braun B = blau flexible shaft textile S = black R = red A = anthracite W = white G = green U = brown B = blue | | |
| -FSO | Flexwelle in Sonderfarbe / Welle kürzen / Welle verlängern (auf max. 100 cm), Aufpreis flexible shaft in special color / to cut short / to extend (max. 100 cm), extra charge | +42,02 | +50,00 |
| -S... | Sockel in Beton G = grau W = weiß standing in concrete G = grey W = white | | |
| A-ABSL -KA -FTA | BESTSELLER – Versandfertig innerhalb von 3 Werktagen* ready for delivery within 3 weekdays* | 630,25 | 750,00 |

A-BSL



Typ

Standleuchte mit Leuchtkopf und Rohr aus massivem Aluminium /// 25–100° stufenlos einstellbarer Abstrahlwinkel durch Glaslinsenoptik /// robuste Flexwelle mit gebürsteter Aluminiumoberfläche oder farbigem Textilüberzug /// Standfuß aus poliertem Beton mit Kabelauflöcher

Dimmung

Tastdimmer am Rohr

Abmessung

Höhe max. 150 cm / Flexwelle 45 cm / Kopf Ø 6,5 cm / Standfuß Ø 23 cm

Lieferung

inkl. USB Steckernetzteil

type

floor light with lamp head and tube made of solid aluminium /// glass lens optics with 25–100° infinitely focusable angle beam /// strong flexible shaft in brushed aluminium or colored textile coating /// standing in polished concrete with rollable power lead

dimming

tube dimmer switch

dimension

height max. 150 cm / flex 45 cm / head Ø 6,5 cm / standing Ø 23 cm

delivery

incl. USB plug transformer

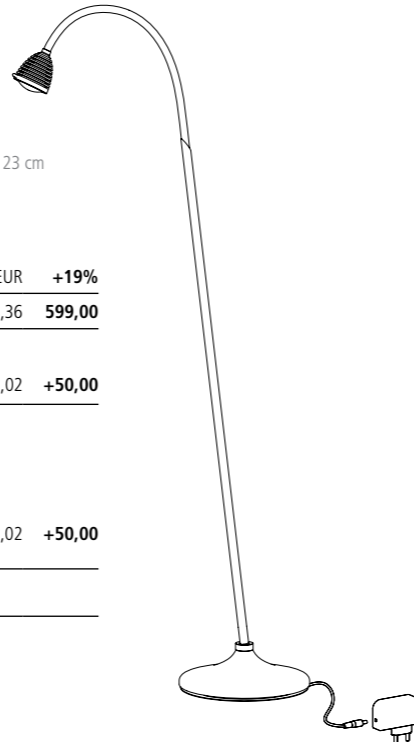

| | | EUR | +19% |
|--------------|---|--------|---------------|
| A-BSL | | 503,36 | 599,00 |
| -KA | Kopf und Rohr in Alu head and tube in alu | | |
| -KS | Kopf und Rohr in schwarz head and tube in black | +42,02 | +50,00 |
| -FA | Flexwelle mit gebürsteter Aluminiumoberfläche flexible shaft in alu brush-finished | | |
| -FT... | Flexwelle Textil S = schwarz R = rot A = anthrazit W = weiß G = grün U = braun B = blau flexible shaft textile S = black R = red A = anthracite W = white G = green U = brown B = blue | | |
| -FSO | Flexwelle in Sonderfarbe / Welle kürzen / Welle verlängern (auf max. 100 cm), Aufpreis flexible shaft in special color / to cut short / to extend (max. 100 cm), extra charge | +42,02 | +50,00 |
| -S... | Sockel in Beton G = grau W = weiß standing in concrete G = grey W = white | | |



A-SL



Typ

Standleuchte mit Leuchtkopf und Rohr aus massivem Aluminium /// 25–100° stufenlos einstellbarer Abstrahlwinkel durch Glaslinsenoptik /// robuste Flexwelle mit gebürsteter Aluminiumoberfläche oder farbigem Textilüberzug /// Standfuß aus satiniertem Edelstahl

type

floor light with lamp head and tube made of solid aluminium /// glass lens optics with 25–100° infinitely focusable angle beam /// strong flexible shaft in brushed aluminium or colored textile coating /// standing in satined stainless steel

Dimmung

Tastdimmer am Rohr

dimming

tube dimmer switch

Abmessung

Höhe max. 145 cm / Flexwelle 45 cm / Kopf Ø 6,5 cm / Standfuß 25 x 25 cm

dimension

height max. 145 cm / flex 45 cm / head Ø 6,5 cm / standing 25 x 25 cm

Lieferung

inkl. USB Steckernetzteil

delivery

incl. USB plug transformer

| | | EUR | +19% |
|----------------------|---|--------|----------------|
| A-SL | | 419,33 | 499,00 |
| -KA | Kopf und Rohr in Alu head and tube in alu | | |
| -KS | Kopf und Rohr in schwarz head and tube in black | +42,02 | +50,00 |
| -KSO | Sonderausführung Standfuß poliert oder schwarz special type standing in polished or black | +84,03 | +100,00 |
| -FA | Flexwelle mit gebürsteter Aluminiumoberfläche flexible shaft in alu brush-finished | | |
| -FT... | Flexwelle Textil S = schwarz R = rot A = anthrazit W = weiß G = grün U = braun B = blau flexible shaft textile S = black R = red A = anthracite W = white G = green U = brown B = blue | | |
| -FSO | Flexwelle in Sonderfarbe / Welle kürzen / Welle verlängern (auf max. 100 cm), Aufpreis flexible shaft in special color / to cut short / to extend (max. 100 cm), extra charge | +42,02 | +50,00 |
| A-SL -KA -FTA | BESTSELLER – Versandfertig innerhalb von 3 Werktagen* ready for delivery within 3 weekdays* | 419,33 | 499,00 |

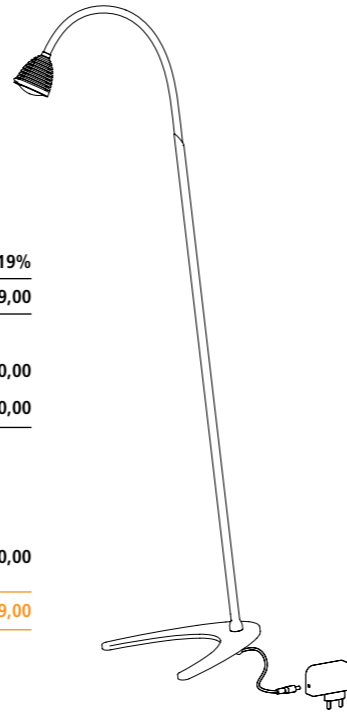

A-6SL



Typ

Sechser Standleuchte mit Leuchtköpfen und Sockel aus massivem Aluminium /// 25–100° stufenlos einstellbarer Abstrahlwinkel durch Glaslinsenoptik /// robuste Flexwellen mit gebürsteter Aluminiumoberfläche oder farbigem Textilüberzug /// weißer Porzellansockel mit Standfuß aus satiniertem Edelstahl

type

six floor light with lamp heads and base made of solid aluminium /// glass lens optics with 25–100° infinitely focusable angle beam /// strong flexible shafts in brushed aluminium or colored textile coating /// white porcelain base with standing in satined stainless steel

Dimmung

Fußdimmer

dimming

foot dimmer switch

Abmessung

Höhe max. 160 cm / Flexwelle 45 cm / Kopf Ø 6,5 cm / Standfuß Ø 30 cm

dimension

height max. 160 cm / flex 45 cm / head Ø 6,5 cm / standing Ø 30 cm

Lieferung

inkl. Schnurteil, transparente Zuleitung mit Schuko stecker

delivery

incl. lead transformer, transparent power lead with schuko plug

| | | EUR | +19% |
|---------------|---|----------|-----------------|
| A-6SL | | 2.100,84 | 2.500,00 |
| -KA | Köpfe in Alu heads in alu | | |
| -KS | Köpfe in schwarz heads in black | +126,05 | +150,00 |
| -FA | Flexwelle mit gebürsteter Aluminiumoberfläche flexible shaft in alu brush-finished | | |
| -FT... | Flexwelle Textil S = schwarz R = rot A = anthrazit W = weiß G = grün U = braun B = blau flexible shaft textile S = black R = red A = anthracite W = white G = green U = brown B = blue | | |
| -FSO | Flexwellen in Sonderfarbe, Aufpreis flexible shafts in special color, extra charge | +126,05 | +150,00 |

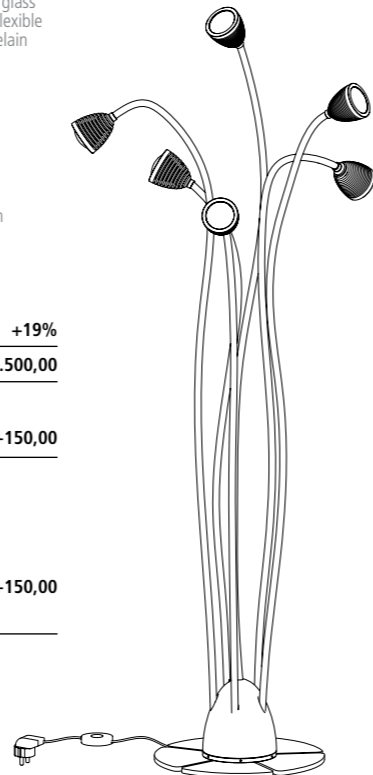

A-HSL



Typ

Standleuchte mit Leuchtkopf aus massivem Aluminium /// 25–100° stufenlos einstellbarer Abstrahlwinkel durch Glaslinsenoptik /// ausziehbarer Flexwelle mit gebürsteter Aluminiumoberfläche /// Standrohr aus massivem Eichenholz /// Standfuß aus satiniertem Edelstahl

Dimmung

Fußdimmer

Abmessung

Höhe max. 150 cm / Flexwelle 35 cm / Kopf Ø 6,5 cm / Standfuß 22 x 25 cm

Lieferung

inkl. Steckernetzteil mit rot / weiß kariertem Textilleitung

type

floor light with lamp head made of solid aluminium /// glass lens optics with 25–100° infinitely focusable angle beam /// extendible flexible shaft in brushed aluminium /// massive oak wood tube /// standing made of stainless steel

dimming

foot dimmer switch

dimension

height max. 150 cm / flex 35 cm / head Ø 6,5 cm / standing 22 x 25 cm

delivery

incl. plug transformer with red / white checkered textile lead

EUR +19%

A-HSL 503,36 **599,00**

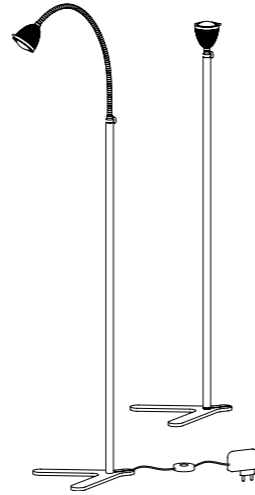

A-3HSL



Typ

Dreier Standleuchte mit Leuchtkopf aus massivem Aluminium /// 25–100° stufenlos einstellbarer Abstrahlwinkel durch Glaslinsenoptik /// drei ausziehbare Flexwellen mit gebürsteter Aluminiumoberfläche /// Standrohre aus massivem Eichenholz

Dimmung

Fußdimmer

Abmessung

Höhe max. 180 cm / Flexwelle 35 cm / Kopf Ø 6,5 cm

Lieferung

inkl. Schnurteil mit rot / weiß kariertem Textilleitung und Eurostecker

type

triple floor light with lamp head made of solid aluminium /// glass lens optics with 25–100° infinitely focusable angle beam /// three extendible flexible shafts in brushed aluminium /// massive oak wood tubes

dimming

foot dimmer switch

dimension

height max. 180 cm / flex 35 cm / head Ø 6,5 cm

delivery

incl. lead transformer with red / white checkered textile lead and Euro plug

EUR +19%

A-3HSL 1.259,66 **1.499,00**

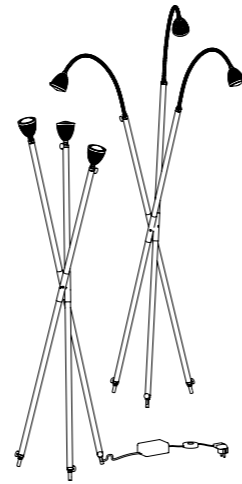



Typ

Mobile Akku Standleuchte mit Leuchtkopf und Teleskoprohr aus massivem Aluminium /// 50–100° stufenlos einstellbarer Abstrahlwinkel durch Glaslinsenoptik /// höhenverstellbares Teleskoprohr mit Lederschlaufe /// Standfuß aus poliertem Beton /// wechselbarer Li-Ionen Akkupack im Sockel /// Leuchtdauer Akku > 6 Std.

Dimmung

Tastdimmer am Leuchtkopf

Abmessung

Höhe max. 140 cm / Teleskop 75–140 cm / Kopf Ø 9 cm / Standfuß Ø 23 cm

Lieferung

inkl. Steckerladegerät, Akku

type

mobile rechargeable battery pack floor light with lamp head and telescope tube made of massive aluminium /// glass lens optics with 50–100° infinitely focusable angle beam /// height adjustable telescope tube with leather loop /// standing in polished concrete /// exchangeable lithium-ion rechargeable pack inside standing /// operation time > 6 hrs.

dimming

dimmer switch at lamp head

dimension

height max. 140 cm / telescope 75–140 cm / head Ø 9 cm / stand Ø 23 cm

delivery

incl. plug charger, rechargeable battery pack

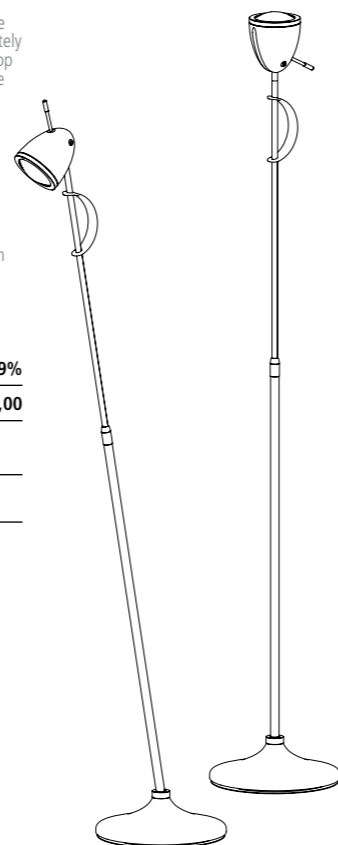

| | | | |
|-------|---|--------|--------|
| | | EUR | +19% |
| Y-ASL | | 839,49 | 999,00 |
| -K... | Kopf in P = poliert SM = schwarz matt SG = schwarz glanz WM = weiß matt WG = weiß glanz head in P = polished SM = black SG = black glossy WM = white WG = white glossy | | |
| -S... | Sockel in Beton G = grau W = weiß standing in concrete G = grey W = white | | |



Typ

Standleuchte mit Leuchtkopf und Teleskoprohr aus massivem Aluminium /// 50–100° stufenlos einstellbarer Abstrahlwinkel durch Glaslinsenoptik /// höhenverstellbares Teleskoprohr mit Lederschlaufe /// Standfuß aus poliertem Beton mit Kabelaufroller

Dimmung

Drehdimmer am Leuchtkopf

Abmessung

Höhe max. 140 cm / Teleskop 75–140 cm / Kopf Ø 9 cm / Standfuß Ø 23 cm

Lieferung

inkl. Netzteil, transparente Zuleitung mit Eurostecker

type

floor light with lamp head and telescope tube made of solid aluminium /// glass lens optics with 50–100° infinitely focusable angle beam /// height adjustable telescope tube with leather loop /// standing made of polished concrete with rollable power lead

dimming

rotary dimmer switch at lamp head

dimension

height max. 140 cm / telescope 75–140 cm / head Ø 9 cm / stand Ø 23 cm

delivery

incl. transformer, transparent power lead with Euro plug

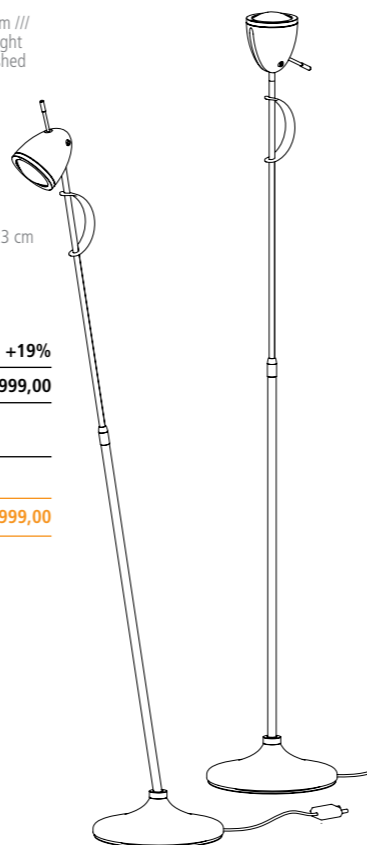

| | | | |
|-------|---|---|---------------|
| | | EUR | +19% |
| Y-SL | | 839,49 | 999,00 |
| -K... | Kopf in P = poliert SM = schwarz matt SG = schwarz glanz WM = weiß matt WG = weiß glanz head in P = polished SM = black SG = black glossy WM = white WG = white glossy | | |
| -S... | Sockel in Beton G = grau W = weiß standing in concrete G = grey W = white | | |
| Y-SL | -KSG -SG | BESTSELLER – Versandfertig innerhalb von 3 Werktagen* ready for delivery within 3 weekdays* | 839,49 999,00 |



Y-3SL



Typ
 Dreier Standleuchte mit Leuchtkopf und Standrohr aus massivem Aluminium
 /// 50–100° stufenlos einstellbarer Abstrahlwinkel durch Glaslinsenoptik ///
 Standfuß aus poliertem Beton mit Kabelaufroller

Dimmung
 1x Drehdimmer für alle 3 Leuchtköpfe

Abmessung
 Höhe max. 160 cm / Kopf Ø 9 cm / Standfuß Ø 23 cm

Lieferung
 inkl. Netzteil, transparente Zuleitung mit Eurostecker

type
 triple floor light with lamp head and standing tube made of solid aluminium
 /// glass lens optics with 50–100° infinitely focusable angle beam /// stan-
 ding made of polished concrete with rollable power lead

dimming
 1x rotary dimmer switch for all 3 lamp heads

dimension
 height max. 160 cm / head Ø 9 cm / stand Ø 23 cm

delivery
 incl. transformer, transparent power lead with Euro plug

EUR +19%

Y-3SL 1.511,76 1.799,00

-K... Kopf in P = poliert SM = schwarz matt SG = schwarz glanz WM = weiß matt WG = weiß glanz
 head in P = polished SM = black SG = black glossy WM = white WG = white glossy

-S... Sockel in Beton G = grau W = weiß standing in concrete G = grey W = white

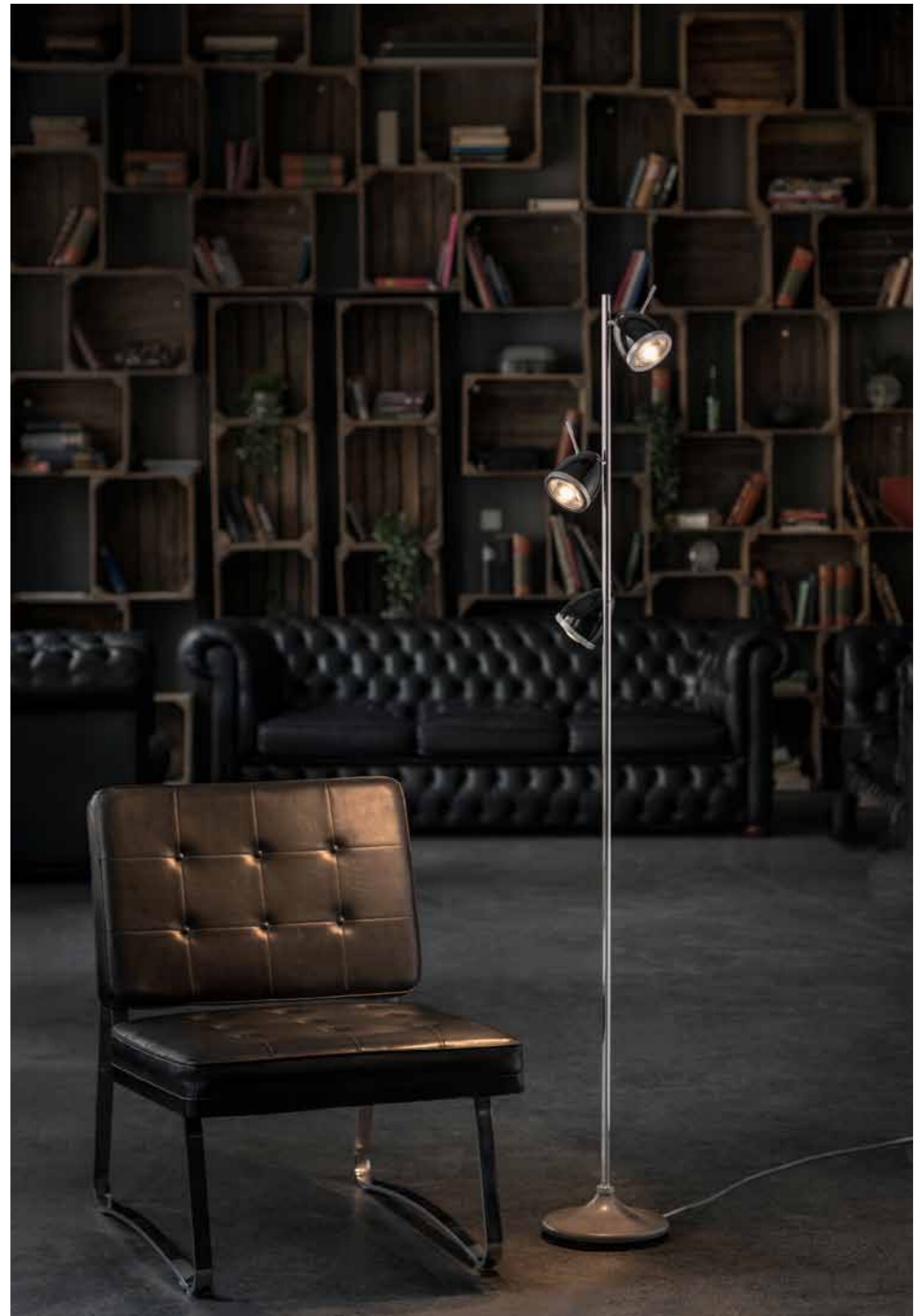
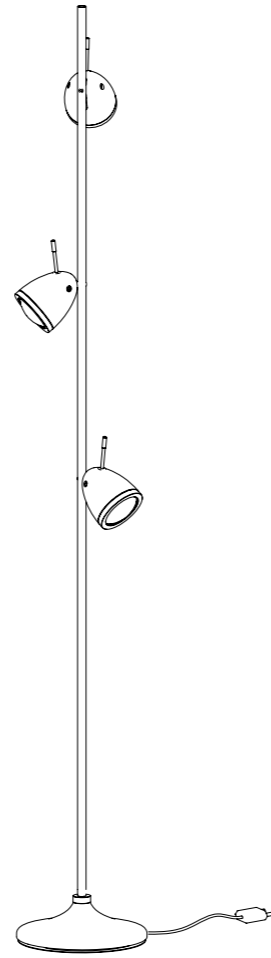

A-BS



Typ

Bodenstrahler aus massivem Aluminium /// 25–100° stufenlos einstellbarer Abstrahlwinkel durch Glaslinsenoptik

type

floor spotlight with lamp head and base made of solid aluminium /// glass lens optics with 25–100° infinitely focusable angle beam

Dimmung

Tastdimmer am Rohr

dimming

base dimmer switch

Abmessung

Höhe 13,5 cm / Kopf Ø 7 cm

dimension

height 13,5 cm / head Ø 7 cm

Lieferung

inkl. USB Steckernetzteil

delivery

incl. USB plug transformer

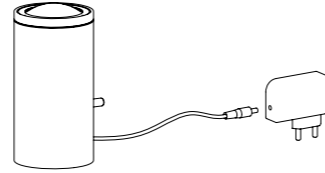

EUR +19%

A-BS 293,28 **349,00**

-K... Korpus in **P** = poliert **S** = schwarz **W** = weiß **G** = gold corpus in **P** = polished **S** = black **W** = white **G** = gold

-S... Kopf **P** = poliert **S** = schwarz **W** = weiß **G** = gold base and head **P** = polished **S** = black **W** = white **G** = gold

Y-BS



Typ

Bodenstrahler mit Leuchtkopf aus massivem Aluminium /// 50–100° stufenlos einstellbarer Abstrahlwinkel durch Glaslinsenoptik /// Standfuß aus poliertem Beton

type

floor spotlight with lamp head made of solid aluminium /// glass lens optics with 50–100° infinitely focusable angle beam /// standing made of polished concrete

Dimmung

Drehdimmer am Leuchtkopf

dimming

rotary dimmer switch at lamp head

Abmessung

Höhe 20 cm / Kopf Ø 9 cm / Sockel Ø 15 cm

dimension

height 20 cm / head Ø 9 cm / base Ø 15 cm

Lieferung

inkl. Netzteil, transparente Zuleitung mit Eurostecker

delivery

incl. transformer, transparent power lead with Euro plug

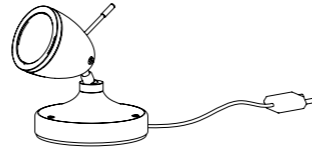

EUR +19%

Y-BS 419,33 **499,00**

-K... Kopf in **P** = poliert **SM** = schwarz matt **SG** = schwarz glanz **WM** = weiß matt **WG** = weiß glanz
head in **P** = polished **SM** = black matt **SG** = black glossy **WM** = white matt **WG** = white glossy

-S... Sockel in Beton **G** = grau **W** = weiß base in concrete **G** = grey **W** = white

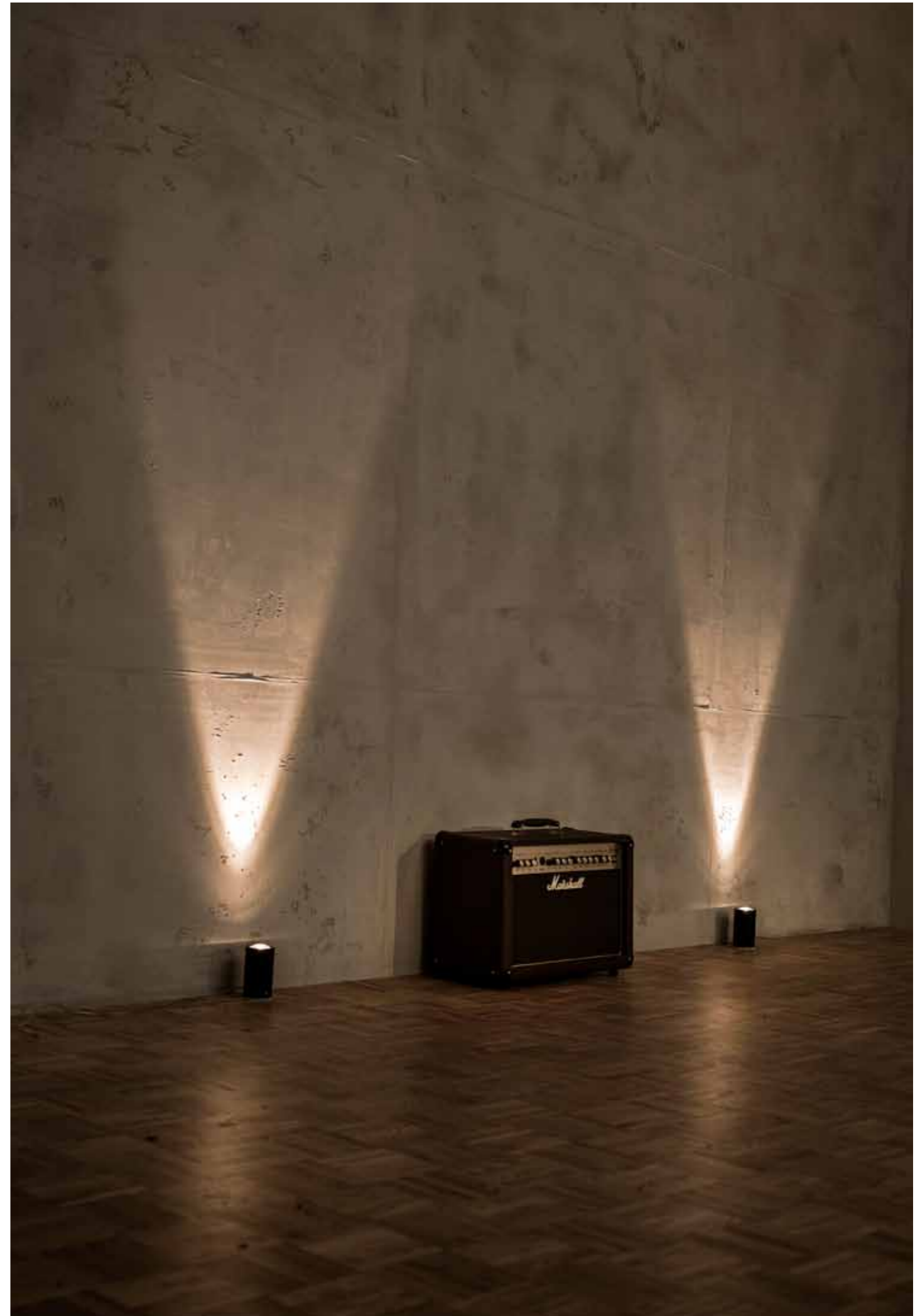

Z-TL



Typ

Tischleuchte mit Leuchtkopf und Rohr aus massivem Aluminium /// 15–75° stufenlos einstellbarer Abstrahlwinkel durch Linsenoptik /// robuste Flexwelle mit gebürsteter Aluminiumoberfläche oder farbigem Textilüberzug /// Standfuß aus satiniertem Edelstahl

type

table light with lamp head and tube made of solid aluminium /// lens optics with 15–75° infinitely focusable angle beam /// strong flexible shaft in brushed aluminium or colored textile coating /// standing made of satined stainless steel

Dimmung

Tastdimmer am Sockel

dimming

base dimmer switch

Abmessung

TL1: Höhe bis 65 cm / Flexwelle 45 cm / Kopf Ø 6,5 cm / Fuß 20 x 20 cm

dimension

TL1: height up to 65 cm / flex 45 cm / head Ø 3 cm / stand 20 x 20 cm

Lieferung

inkl. USB Steckernetzteil

delivery

incl. USB plug transformer

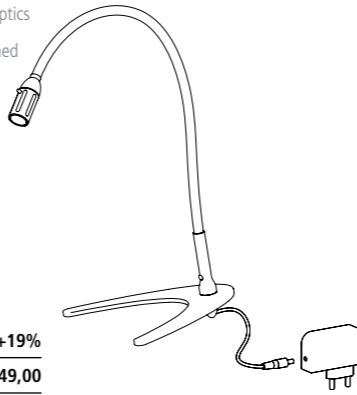

| Z-TL1 | | EUR | +19% |
|--------|---|--------|----------------|
| | | 289,91 | 349,00 |
| -KA | Kopf und Rohr in Alu head and tube in alu | | |
| -KS | Kopf und Rohr in schwarz head and tube in black | +42,02 | +50,00 |
| -KSO | Sonderausführung Standfuß poliert oder schwarz special type standing in polished or black | +84,03 | +100,00 |
| -FA | Flexwelle mit gebürsteter Aluminiumoberfläche flexible shaft in alu brush-finished | | |
| -FT... | Flexwelle Textil S = schwarz R = rot A = anthrazit W = weiß G = grün U = braun B = blau flexible shaft textile S = black R = red A = anthracite W = white G = green U = brown B = blue | | |
| | | | |
| -FSO | Flexwelle in Sonderfarbe / Welle kürzen / Welle verlängern (auf max. 100 cm), Aufpreis flexible shaft in special color / to cut short / to extend (max. 100 cm), extra charge | +42,02 | +50,00 |

A-TL



Typ

Tischleuchte mit Leuchtkopf und Rohr aus massivem Aluminium /// 25–100° stufenlos einstellbarer Abstrahlwinkel durch Glaslinsenoptik /// robuste Flexwelle mit gebürsteter Aluminiumoberfläche oder farbigem Textilüberzug /// Standfuß aus satiniertem Edelstahl

type

table light with lamp head and tube made of solid aluminium /// glass lens optics with 25–100° infinitely focusable angle beam /// strong flexible shaft in brushed aluminium or colored textile coating /// standing made of satined stainless steel

Dimmung

Tastdimmer am Sockel

dimming

base dimmer switch

Abmessung

TL1: Höhe bis 65 cm / Flexwelle 45 cm / Kopf Ø 6,5 cm / Fuß 20 x 20 cm

TL2: Höhe bis 85 cm / Flexwelle 45 cm / Kopf Ø 6,5 cm / Fuß 20 x 20 cm

dimension

TL1: height up to 65 cm / flex 45 cm / head Ø 6,5 cm / stand 20 x 20 cm

TL2: height up to 85 cm / flex 45 cm / head Ø 6,5 cm / stand 20 x 20 cm

Lieferung

inkl. USB Steckernetzteil

delivery

incl. USB plug transformer

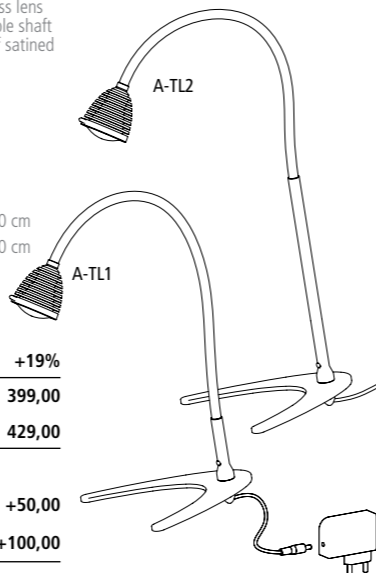

| A-TL1 | | EUR | +19% |
|--------|---|--------|----------------|
| | | 335,29 | 399,00 |
| A-TL2 | | 360,50 | 429,00 |
| -KA | Kopf und Rohr in Alu head and tube in alu | | |
| -KS | Kopf und Rohr in schwarz head and tube in black | +42,02 | +50,00 |
| -KSO | Sonderausführung Standfuß poliert oder schwarz special type standing in polished or black | +84,03 | +100,00 |
| -FA | Flexwelle mit gebürsteter Aluminiumoberfläche flexible shaft in alu brush-finished | | |
| -FT... | Flexwelle Textil S = schwarz R = rot A = anthrazit W = weiß G = grün U = braun B = blau flexible shaft textile S = black R = red A = anthracite W = white G = green U = brown B = blue | | |
| | | | |
| -FSO | Flexwelle in Sonderfarbe / Welle kürzen / Welle verlängern (auf max. 100 cm), Aufpreis flexible shaft in special color / to cut short / to extend (max. 100 cm), extra charge | +42,02 | +50,00 |



Z-KL



Typ

Klemmleuchte mit Leuchtkopf und Rohr aus massivem Aluminium /// 15–75° stufenlos einstellbarer Abstrahlwinkel durch Linsenoptik /// robuste Flexwelle mit gebürsteter Aluminiumoberfläche oder farbigem Textilüberzug /// Schraubklemme aus satiniertem Edelstahl

type

clamp light with lamp head and tube made of solid aluminium /// lens optics with 15–75° infinitely focusable angle beam /// strong flexible shaft in brushed aluminium or colored textile coating /// screw clamp made of satined stainless steel

Dimmung

Tastdimmer am Sockel

dimming

base dimmer switch

Abmessung

KL1: Höhe max. 65 cm / Flexwelle 45 cm / Kopf Ø 3 cm

dimension

KL1: height up to 65 cm / flex 45 cm / head Ø 3 cm

Lieferung

inkl. USB Steckernetzteil

delivery

incl. USB plug transformer

| | | EUR | +19% |
|---------------|---|--------|---------------|
| Z-KL1 | | 289,91 | 349,00 |
| -KA | Kopf und Rohr in Alu head and tube in alu | | |
| -KS | Kopf und Rohr in schwarz head and tube in black | +42,02 | +50,00 |
| -FA | Flexwelle mit gebürsteter Aluminiumoberfläche flexible shaft in alu brush-finished | | |
| -FT... | Flexwelle Textil S = schwarz R = rot A = anthrazit W = weiß G = grün U = braun B = blau flexible shaft textile S = black R = red A = anthracite W = white G = green U = brown B = blue | | |
| -FSO | Flexwelle in Sonderfarbe / Welle kürzen / Welle verlängern (auf max. 100 cm), Aufpreis flexible shaft in special color / to cut short / to extend (max. 100 cm), extra charge | +42,02 | +50,00 |

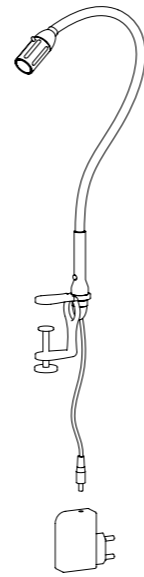

A-KL



Typ

Klemmleuchte mit Leuchtkopf und Rohr aus massivem Aluminium /// 25–100° stufenlos einstellbarer Abstrahlwinkel durch Glaslinsenoptik /// robuste Flexwelle mit gebürsteter Aluminiumoberfläche oder farbigem Textilüberzug /// Schraubklemme aus satiniertem Edelstahl

type

clamp light with lamp head and tube made of solid aluminium /// glass lens optics with 25–100° infinitely focusable angle beam /// strong flexible shaft in brushed aluminium or colored textile coating /// screw clamp made of satined stainless steel

Dimmung

Tastdimmer am Sockel

dimming

base dimmer switch

Abmessung

KL1: Höhe max. 65 cm / Flexwelle 45 cm / Kopf Ø 6,5 cm

KL2: Höhe max. 85 cm / Flexwelle 45 cm / Kopf Ø 6,5 cm

dimension

KL1: height up to 65 cm / flex 45 cm / head Ø 6,5 cm

KL2: height up to 85 cm / flex 45 cm / head Ø 6,5 cm

Lieferung

inkl. USB Steckernetzteil

delivery

incl. USB plug transformer

| | | EUR | +19% |
|---------------|---|--------|---------------|
| A-KL1 | | 335,29 | 399,00 |
| A-KL2 | | 360,50 | 429,00 |
| -KA | Kopf und Rohr in Alu head and tube in alu | | |
| -KS | Kopf und Rohr in schwarz head and tube in black | +42,02 | +50,00 |
| -FA | Flexwelle mit gebürsteter Aluminiumoberfläche flexible shaft in alu brush-finished | | |
| -FT... | Flexwelle Textil S = schwarz R = rot A = anthrazit W = weiß G = grün U = braun B = blau flexible shaft textile S = black R = red A = anthracite W = white G = green U = brown B = blue | | |
| -FSO | Flexwelle in Sonderfarbe / Welle kürzen / Welle verlängern (auf max. 100 cm), Aufpreis flexible shaft in special color / to cut short / to extend (max. 100 cm), extra charge | +42,02 | +50,00 |

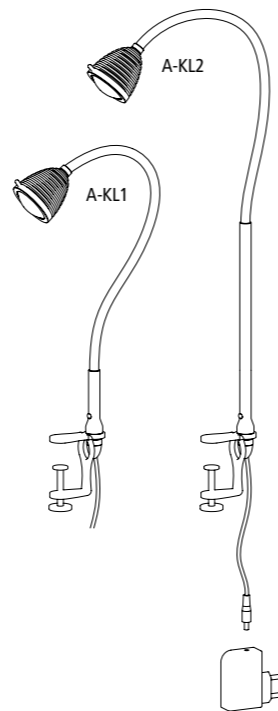

Z-ML



Typ

Magnetleuchte mit Leuchtkopf und Rohr aus massivem Aluminium ///
15–75° stufenlos einstellbarer Abstrahlwinkel durch Linsenoptik /// robuste
Flexwelle mit gebürsteter Aluminiumoberfläche oder farbigem Textilüberzug
/// Sockel aus schwarz gepulvertem Stahl mit haftstarken Neodym Magneten

type

magnetic light with lamp head and tube made of solid aluminium /// lens
optics with 15–75° infinitely focusable angle beam /// strong flexible shaft
in brushed aluminium or colored textile coating /// black powder-coated steel
base with strong neodym magnets

Dimmung

Tastdimmer am Sockel

dimming

base dimmer switch

Abmessung

ML1: Höhe max. 65 cm / Flexwelle 45 cm / Kopf Ø 3 cm / Sockel Ø 6 cm

dimension

ML1: height up to 65 cm / flex 45 cm / head Ø 3 cm / base Ø 6 cm

Lieferung

inkl. USB Steckernetzteil

delivery

incl. USB plug transformer

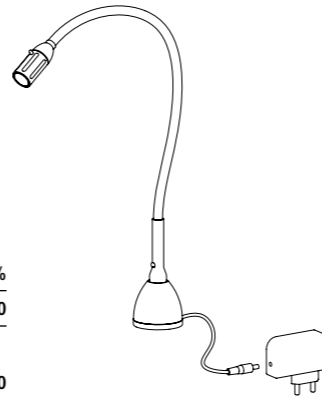

| | | EUR | +19% |
|---------------|---|--------|---------------|
| Z-ML1 | | 289,91 | 349,00 |
| -KA | Kopf und Rohr in Alu head and tube in alu | | |
| -KS | Kopf und Rohr in schwarz head and tube in black | +42,02 | +50,00 |
| -FA | Flexwelle mit gebürsteter Aluminiumoberfläche flexible shaft in alu brush-finished | | |
| -FT... | Flexwelle Textil S = schwarz R = rot A = anthrazit W = weiß G = grün U = braun B = blau flexible shaft textile S = black R = red A = anthracite W = white G = green U = brown B = blue | | |
| -FSO | Flexwelle in Sonderfarbe / Welle kürzen / Welle verlängern (auf max. 100 cm), Aufpreis flexible shaft in special color / to cut short / to extend (max. 100 cm), extra charge | +42,02 | +50,00 |

A-ML



Typ

Magnetleuchte mit Leuchtkopf und Rohr aus massivem Aluminium ///
25–100° stufenlos einstellbarer Abstrahlwinkel durch Glaslinsenoptik ///
robuste Flexwelle mit gebürsteter Aluminiumoberfläche oder farbigem
Textilüberzug /// Sockel aus schwarz gepulvertem Stahl mit haftstarken
Neodym Magneten

type

magnetic light with lamp head and tube made of solid aluminium /// glass
lens optics with 25–100° infinitely focusable angle beam /// strong flexible
shaft in brushed aluminium or colored textile coating /// black powder-coa-
ted steel base with strong neodym magnets

Dimmung

Tastdimmer am Sockel

dimming

base dimmer switch

Abmessung

ML1: Höhe max. 65 cm / Flexwelle 45 cm / Kopf Ø 6,5 cm / Sockel Ø 6 cm
ML2: Höhe max. 85 cm / Flexwelle 45 cm / Kopf Ø 6,5 cm / Sockel Ø 6 cm

dimension

ML1: height up to 65 cm / flex 45 cm / head Ø 6,5 cm / base Ø 6 cm
ML2: height up to 85 cm / flex 45 cm / head Ø 6,5 cm base Ø 6 cm

Lieferung

inkl. USB Steckernetzteil

delivery

incl. USB plug transformer

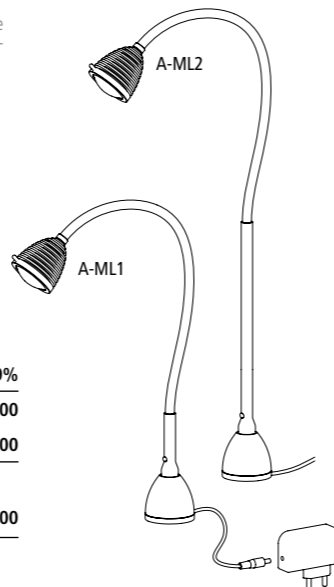

| | | EUR | +19% |
|---------------|---|--------|---------------|
| A-ML1 | | 335,29 | 399,00 |
| A-ML2 | | 360,50 | 429,00 |
| -KA | Kopf und Rohr in Alu head and tube in alu | | |
| -KS | Kopf und Rohr in schwarz head and tube in black | +42,02 | +50,00 |
| -FA | Flexwelle mit gebürsteter Aluminiumoberfläche flexible shaft in alu brush-finished | | |
| -FT... | Flexwelle Textil S = schwarz R = rot A = anthrazit W = weiß G = grün U = braun B = blau flexible shaft textile S = black R = red A = anthracite W = white G = green U = brown B = blue | | |
| -FSO | Flexwelle in Sonderfarbe / Welle kürzen / Welle verlängern (auf max. 100 cm), Aufpreis flexible shaft in special color / to cut short / to extend (max. 100 cm), extra charge | +42,02 | +50,00 |





Z-BDL



Typ

Wand-/Deckenleuchte mit Leuchtkopf und Sockel aus massivem Aluminium
 /// 15–75° stufenlos einstellbarer Abstrahlwinkel durch Linsenoptik ///
 robuste Flexwelle mit gebürsteter Aluminiumoberfläche oder farbigem
 Textilüberzug

Montage

Netzteil innerhalb Sockel /// Montage über Unterputzdose optional mit
 Adapterteller möglich /// Montage mehrerer Leuchten in Reihe durch Verbin-
 dungswellen möglich

Dimmung

wahlweise phasendimmbar oder mit Tastdimmer am Sockel

Abmessung

BDL1: Länge bis 35 cm / Flexwelle 15 cm / Sockel Ø 6,5 cm / Kopf Ø 3 cm
 BDL2: Länge bis 65 cm / Flexwelle 45 cm / Sockel Ø 6,5 cm / Kopf Ø 3 cm

Lieferung

inkl. Netzteil, Schrauben

type

wall/ceiling light with lamp head and base made of solid aluminium /// lens
 optics with 15–75° infinitely focusable angle beam /// strong flexible shaft in
 brushed aluminium or colored textile coating

installation

transformer inside base /// optional flush-mounting installation by counting
 plate /// row connection of several lights with connecting shafts possible

dimming

optional phase-cut dimming or with base dimmer switch

dimension

BDL1: length up to 35 cm / flex 15 cm / base Ø 6,5 cm / head Ø 3 cm
 BDL2: length up to 65 cm / flex 45 cm / base Ø 6,5 cm / head Ø 3 cm

delivery

incl. transformer, screws

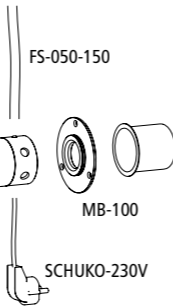
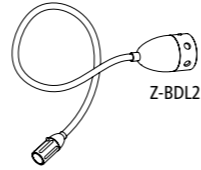
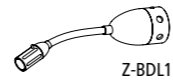
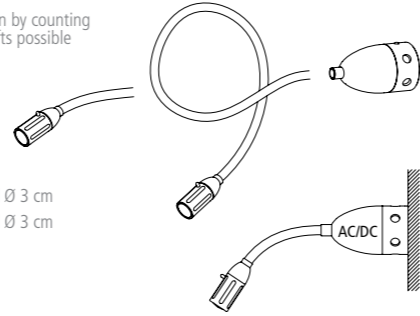

| | | EUR | +19% |
|--------------|---|--------|--------|
| Z-BDL1-P | phasendimmbar phase-cut dimming | 259,66 | 309,00 |
| Z-BDL1-S | Tastdimmer am Sockel base dimmer switch | 276,47 | 329,00 |
| Z-BDL2-P | phasendimmbar phase-cut dimming | 276,47 | 329,00 |
| Z-BDL2-S | Tastdimmer am Sockel base dimmer switch | 293,28 | 349,00 |
| -KA | Kopf und Sockel in Alu head and base in alu | | |
| -KS | Kopf und Sockel in schwarz head and base in black | +42,02 | +50,00 |
| -FA | Flexwelle mit gebürsteter Aluminiumoberfläche flexible shaft in alu brush-finished | | |
| -FT... | Flexwelle Textil S = schwarz R = rot A = anthrazit W = weiß G = grün U = braun B = blau flexible shaft textile S = black R = red A = anthracite W = white G = green U = brown B = blue | | |
| -FSO | Flexwelle in Sonderfarbe / Welle kürzen / Welle verlängern (auf max. 100 cm), Aufpreis flexible shaft in special color / to cut short / to extend (max. 100 cm), extra charge | +42,02 | +50,00 |
| FS-050 | 50 cm Verbindungswelle 230V 50 cm connecting shaft 230V | 42,02 | 50,00 |
| FS-100 | 100 cm Verbindungswelle 100 cm connecting shaft | 63,02 | 75,00 |
| FS-150 | 150 cm Verbindungswelle 230V 150 cm connecting shaft 230V | 84,03 | 100,00 |
| MB-100 | Montageteller Ø 10 cm (zur Montage über Unterputzdose) counting plate Ø 10 cm (for flush-mounting installation) | 33,61 | 40,00 |
| SO-Ø65x35 | Sockel zur externen Stromspeisung in Verbindungswelle base for external power supply in connecting shaft | 50,42 | 60,00 |
| SCHUKO-230V | Zuleitung mit Schuko Stecker (zur Montage am Sockel) power lead with schuko plug (for base installation) | 16,81 | 20,00 |
| SCHWEIZ-230V | Zuleitung mit Schweiz Stecker (zur Montage am Sockel) power lead with swiss plug (for base installation) | 16,81 | 20,00 |

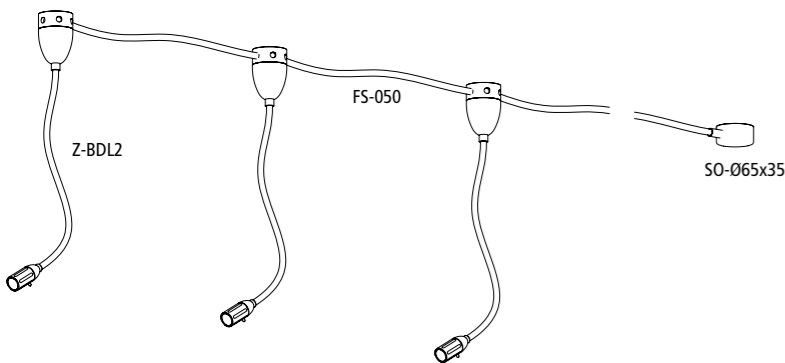

A-BDL



Typ

Wand-/Deckenleuchte mit Leuchtkopf und Sockel aus massivem Aluminium
 /// 25–100° stufenlos einstellbarer Abstrahlwinkel durch Glaslinsenoptik ///
 robuste Flexwelle mit gebürsteter Aluminiumoberfläche oder farbigem
 Textilüberzug

Montage

Netzteil innerhalb Sockel /// Montage über Unterputzdose optional mit
 Adapterteller möglich /// Montage mehrerer Leuchten in Reihe durch Verbin-
 dungswellen möglich

Dimmung

wahlweise phasendimmbar oder mit Tastdimmer am Sockel

Abmessung

BDL1: Länge bis 35 cm / Flexwelle 15 cm / Sockel Ø 6,5 cm / Kopf Ø 6,5 cm
 BDL2: Länge bis 65 cm / Flexwelle 45 cm / Sockel Ø 6,5 cm / Kopf Ø 6,5 cm

Lieferung

inkl. Netzteil, Schrauben

type

wall/ceiling light with lamp and base made of solid aluminium /// glass lens
 optics with 25–100° infinitely focusable angle beam /// strong flexible shaft
 in brushed aluminium or colored textile coating

installation

transformer inside base /// optional flush-mounting installation by counting
 plate /// row connection of several lights with connecting shafts

dimming

optional phase-cut dimming or with base dimmer switch

dimension

BDL1: length up to 35 cm / flex 15 cm / base Ø 6,5 cm / head Ø 6,5 cm
 BDL2: length up to 65 cm / flex 45 cm / base Ø 6,5 cm / head Ø 6,5 cm

delivery

incl. transformer, screws

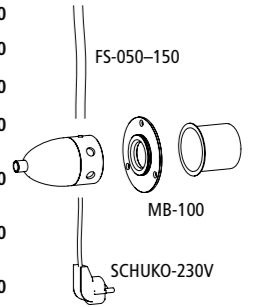
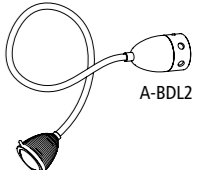
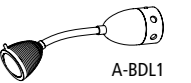
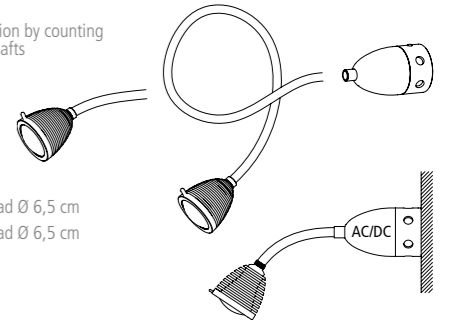

| | | EUR | +19% |
|-------------------|---|--------|--------|
| A-BDL1-P | phasendimmbar phase-cut dimming | 301,68 | 359,00 |
| A-BDL1-S | Tastdimmer am Sockel base dimmer switch | 318,49 | 379,00 |
| A-BDL2-P | phasendimmbar phase-cut dimming | 318,49 | 379,00 |
| A-BDL2-S | Tastdimmer am Sockel base dimmer switch | 335,29 | 399,00 |
| -KA | Kopf und Sockel in Alu head and base in alu | | |
| -KS | Kopf und Sockel in schwarz head and base in black | +42,02 | +50,00 |
| -FA | Flexwelle mit gebürsteter Aluminiumoberfläche flexible shaft in alu brush-finished | | |
| -FT... | Flexwelle Textil S = schwarz R = rot A = anthrazit W = weiß G = grün U = braun B = blau flexible shaft textile S = black R = red A = anthracite W = white G = green U = brown B = blue | | |
| -FSO | Flexwelle in Sonderfarbe / Welle kürzen / Welle verlängern (auf max. 100 cm), Aufpreis flexible shaft in special color / to cut short / to extend (max. 100 cm), extra charge | +42,02 | +50,00 |
| A-BDL2-S -KA -FTA | BESTSELLER – Versandfertig innerhalb von 3 Werktagen* ready for delivery within 3 weekdays* | 335,29 | 399,00 |
| A-BDL2-S -KA -FTR | BESTSELLER – Versandfertig innerhalb von 3 Werktagen* ready for delivery within 3 weekdays* | 335,29 | 399,00 |
| FS-050 | 50 cm Verbindungswelle 230V mit 230V 50 cm connecting shaft 230V | 42,02 | 50,00 |
| FS-100 | 100 cm Verbindungswelle 100 cm connecting shaft | 63,02 | 75,00 |
| FS-150 | 150 cm Verbindungswelle 150 cm connecting shaft | 84,03 | 100,00 |
| MB-100 | Montageteller Ø 10 cm (zur Montage über Unterputzdose) counting plate Ø 10 cm (for flush-mounting installation) | 33,61 | 40,00 |
| SO-Ø65x35 | Sockel zur externen Stromspeisung in Verbindungswelle base for external power supply in connecting shaft | 50,42 | 60,00 |
| SCHUKO-230V | Zuleitung mit Schuko Stecker (zur Montage am Sockel) power lead with schuko plug (for base installation) | 16,81 | 20,00 |
| SCHWEIZ-230V | Zuleitung mit Schweiz Stecker (zur Montage am Sockel) power lead with swiss plug (for base installation) | 16,81 | 20,00 |

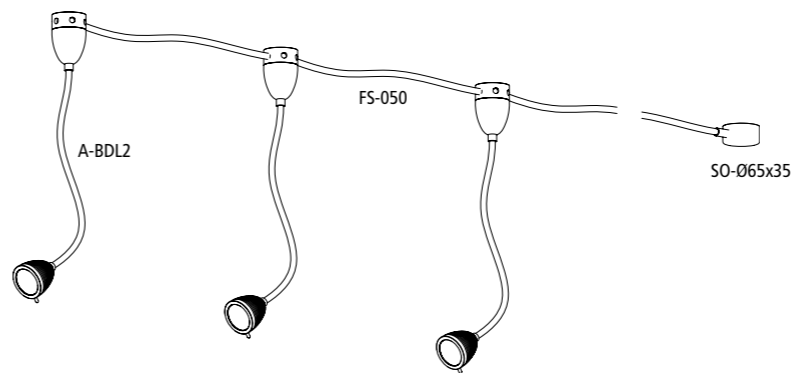

Z-BWL



Typ

Wandleuchte mit Leuchtkopf und Sockel aus massivem Aluminium /// 15–75° stufenlos einstellbarer Abstrahlwinkel durch Linsenoptik /// robuste Flexwelle mit gebürsteter Aluminiumoberfläche oder farbigem Textilüberzug

type

wall light with lamp head and base made of solid aluminium /// lens optics with 15–75° infinitely focusable angle beam /// strong flexible shaft in brushed aluminium or colored textile coating

Montage

Netzteil innerhalb Sockel /// Montage über Unterputzdose möglich

installation

transformer inside base /// flush-mounting installation possible

Dimmung

wahlweise phasendimmbar oder mit Tastdimmer am Sockel

dimming

optional phase-cut dimming or with base dimmer switch

Abmessung

BWL2: Länge bis 65 cm / Flexwelle 45 cm / Sockel Ø 10 cm / Kopf Ø 3 cm

dimension

BWL2: length up to 65 cm / flex 45 cm / base Ø 10 cm / head Ø 3 cm

Lieferung

inkl. Netzteil, Schrauben

delivery

incl. transformer, screws

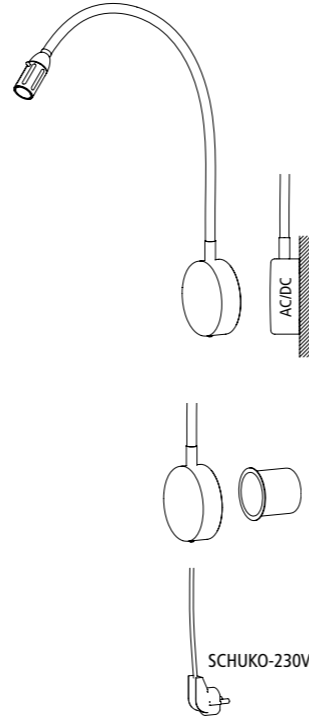

| | | EUR | +19% |
|--------------|--|--------|--------|
| Z-BWL2-P | phasendimmbar phase-cut dimming | 276,47 | 329,00 |
| Z-BWL2-S | Tastdimmer am Sockel base dimmer switch | 293,28 | 349,00 |
| -KA | Kopf und Sockel in Alu head and base in alu | | |
| -KS | Kopf und Sockel in schwarz head and base in black | +42,02 | +50,00 |
| -FA | Flexwelle mit gebürsteter Aluminiumoberfläche flexible shaft in alu brush-finished | | |
| -FT... | Flexwelle Textil S = schwarz R = rot A = anthrazit W = weiß G = grün U = braun B = blau flexible shaft textile S = black R = red A = anthracite W = white G = green U = brown B = blue | | |
| -FSO | Flexwelle in Sonderfarbe / Welle kürzen / Welle verlängern (auf max. 100 cm), Aufpreis flexible shaft in special color / to cut short / to extend (max. 100 cm), extra charge | +42,02 | +50,00 |
| SCHUKO-230V | Zuleitung mit Schuko Stecker (zur Montage am Sockel) power lead with schuko plug (for base installation) | 16,81 | 20,00 |
| SCHWEIZ-230V | Zuleitung mit Schweiz Stecker (zur Montage am Sockel) power lead with swiss plug (for base installation) | 16,81 | 20,00 |

A-BWL



Typ

Wandleuchte mit Leuchtkopf und Sockel aus massivem Aluminium /// 25–100° stufenlos einstellbarer Abstrahlwinkel durch Glaslinsenoptik /// robuste Flexwelle mit gebürsteter Aluminiumoberfläche oder farbigem Textilüberzug

type

wall light with lamp head and base made of solid aluminium /// glass lens optics with 25–100° infinitely focusable angle beam /// strong flexible shaft in brushed aluminium or colored textile coating

Montage

Netzteil innerhalb Sockel /// Montage über Unterputzdose möglich

installation

transformer inside base /// flush-mounting installation possible

Dimmung

wahlweise phasendimmbar oder mit Tastdimmer am Sockel

dimming

optional phase-cut dimming or with base dimmer switch

Abmessung

BWL2: Länge bis 65 cm / Flexwelle 45 cm / Sockel Ø 10 cm / Kopf Ø 6,5 cm

dimension

BWL2: length up to 65 cm / flex 45 cm / base Ø 10 cm / head Ø 6,5 cm

Lieferung

inkl. Netzteil, Schrauben

delivery

incl. transformer, screws

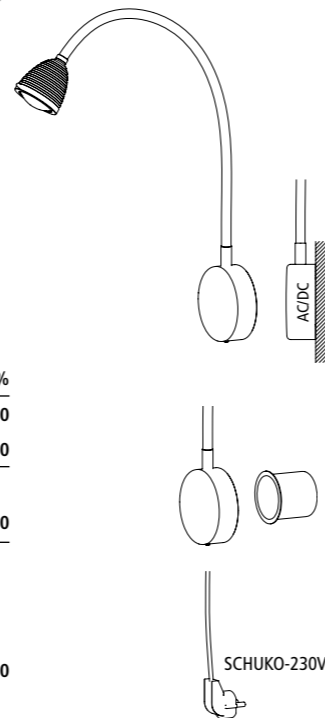

| | | EUR | +19% |
|--------------|--|--------|--------|
| A-BWL2-P | phasendimmbar phase-cut dimming | 318,49 | 379,00 |
| A-BWL2-S | Tastdimmer am Sockel base dimmer switch | 335,29 | 399,00 |
| -KA | Kopf und Sockel in Alu head and base in alu | | |
| -KS | Kopf und Sockel in schwarz head and base in black | +42,02 | +50,00 |
| -FA | Flexwelle mit gebürsteter Aluminiumoberfläche flexible shaft in alu brush-finished | | |
| -FT... | Flexwelle Textil S = schwarz R = rot A = anthrazit W = weiß G = grün U = braun B = blau flexible shaft textile S = black R = red A = anthracite W = white G = green U = brown B = blue | | |
| -FSO | Flexwelle in Sonderfarbe / Welle kürzen / Welle verlängern (auf max. 100 cm), Aufpreis flexible shaft in special color / to cut short / to extend (max. 100 cm), extra charge | +42,02 | +50,00 |
| SCHUKO-230V | Zuleitung mit Schuko Stecker (zur Montage am Sockel) power lead with schuko plug (for base installation) | 16,81 | 20,00 |
| SCHWEIZ-230V | Zuleitung mit Schweiz Stecker (zur Montage am Sockel) power lead with swiss plug (for base installation) | 16,81 | 20,00 |

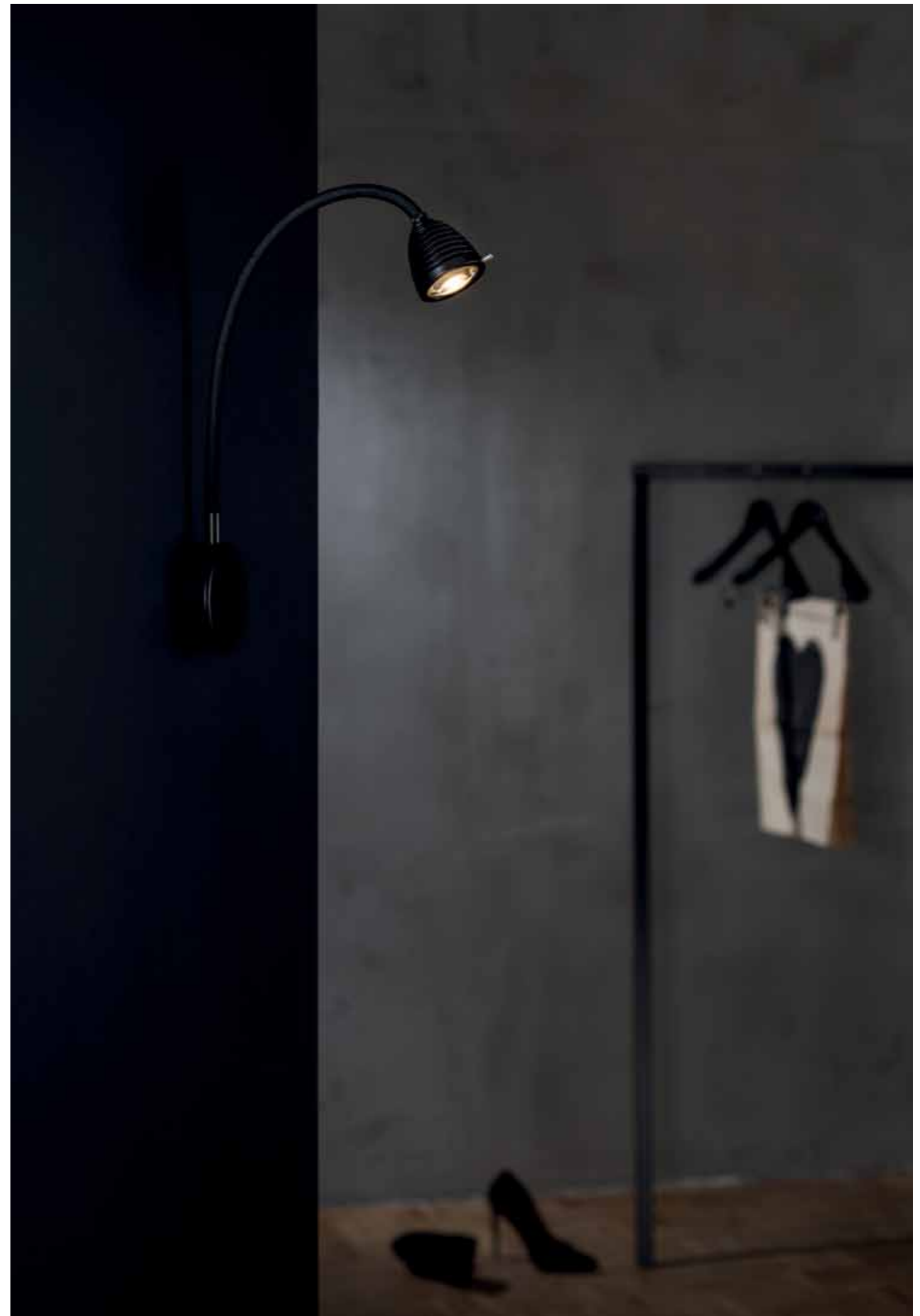



Typ

Aufbauleuchte mit Leuchtkopf und Sockel aus massivem Aluminium /// 15–75° stufenlos einstellbarer Abstrahlwinkel durch Linsenoptik /// robuste Flexwelle mit gebürsteter Aluminiumoberfläche oder farbigem Textilüberzug

type

buildup light with lamp head and base made of solid aluminium /// lens optics with 15–75° infinitely focusable angle beam /// strong flexible shaft in brushed aluminium or colored textile coating

Montage

Netzteil außerhalb Sockel (nur von hinten montierbar, Netzteil passt nicht durch Montageöffnung)

installation

transformer outside base (only backside installation, transformer doesn't fit through installation hole)

Dimmung

wahlweise phasendimmbar oder mit Tastdimmer am Sockel

dimming

optional phase-cut dimming or with base dimmer switch

Abmessung

AL1: Länge bis 35 cm / Flexwelle 15 cm / Sockel Ø 6 cm / Kopf Ø 3 cm
AL2: Länge bis 65 cm / Flexwelle 45 cm / Sockel Ø 6 cm / Kopf Ø 3 cm

dimension

AL1: length up to 35 cm / flex 15 cm / base Ø 6 cm / head Ø 3 cm
AL2: length up to 65 cm / flex 45 cm / base Ø 6 cm / head Ø 3 cm

Lieferung

inkl. Netzteil, Schrauben

delivery

incl. transformer, screws

| | | EUR | +19% |
|---------|---|--------|--------|
| Z-AL1-P | phasendimmbar phase-cut dimming | 242,86 | 289,00 |
| Z-AL1-S | Tastdimmer am Sockel base dimmer switch | 259,66 | 309,00 |
| Z-AL2-P | phasendimmbar phase-cut dimming | 259,66 | 309,00 |
| Z-AL2-S | Tastdimmer am Sockel base dimmer switch | 276,47 | 329,00 |
| -KA | Kopf und Sockel in Alu head and base in alu | | |
| -KS | Kopf und Sockel in schwarz head and base in black | +42,02 | +50,00 |
| -FA | Flexwelle mit gebürsteter Aluminiumoberfläche flexible shaft in alu brush-finished | | |
| -FT... | Flexwelle Textil S = schwarz R = rot A = anthrazit W = weiß G = grün U = braun B = blau flexible shaft textile S = black R = red A = anthracite W = white G = green U = brown B = blue | | |
| -FSO | Flexwelle in Sonderfarbe / Welle kürzen / Welle verlängern (auf max. 100 cm), Aufpreis flexible shaft in special color / to cut short / to extend (max. 100 cm), extra charge | +42,02 | +50,00 |

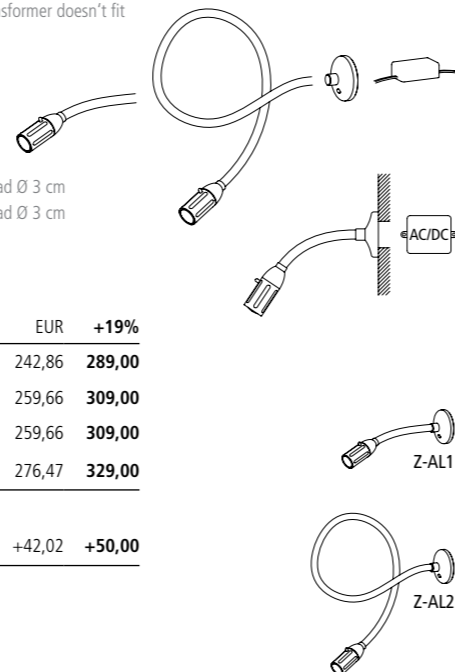

Typ

Aufbauleuchte mit Leuchtkopf und Sockel aus massivem Aluminium /// 25–100° stufenlos einstellbarer Abstrahlwinkel durch Glaslinsenoptik /// robuste Flexwelle mit gebürsteter Aluminiumoberfläche oder farbigem Textilüberzug

type

buildup light with lamp head and base made of solid aluminium /// glass lens optics with 25–100° infinitely focusable angle beam /// strong flexible shaft in brushed aluminium or colored textile coating

Montage

Netzteil außerhalb Sockel (nur von hinten montierbar, Netzteil passt nicht durch Montageöffnung)

installation

transformer outside base (only backside installation, transformer doesn't fit through installation hole)

Dimmung

wahlweise phasendimmbar oder mit Tastdimmer am Sockel

dimming

optional phase-cut dimming or with base dimmer switch

Abmessung

AL1: Länge bis 35 cm / Flexwelle 15 cm / Sockel Ø 6 cm / Kopf Ø 6,5 cm
AL2: Länge bis 65 cm / Flexwelle 45 cm / Sockel Ø 6 cm / Kopf Ø 6,5 cm

dimension

AL1: length up to 35 cm / flex 15 cm / base Ø 6 cm / head Ø 6,5 cm
AL2: length up to 65 cm / flex 45 cm / base Ø 6 cm / head Ø 6,5 cm

Lieferung

inkl. Netzteil, Schrauben

delivery

incl. transformer, screws

| | | EUR | +19% |
|---------|---|--------|--------|
| A-AL1-P | phasendimmbar phase-cut dimming | 284,87 | 339,00 |
| A-AL1-S | Tastdimmer am Sockel base dimmer switch | 301,68 | 359,00 |
| A-AL2-P | phasendimmbar phase-cut dimming | 301,68 | 359,00 |
| A-AL2-S | Tastdimmer am Sockel base dimmer switch | 318,49 | 379,00 |
| -KA | Kopf und Sockel in Alu head and base in alu | | |
| -KS | Kopf und Sockel in schwarz head and base in black | +42,02 | +50,00 |
| -FA | Flexwelle mit gebürsteter Aluminiumoberfläche flexible shaft in alu brush-finished | | |
| -FT... | Flexwelle Textil S = schwarz R = rot A = anthrazit W = weiß G = grün U = braun B = blau flexible shaft textile S = black R = red A = anthracite W = white G = green U = brown B = blue | | |
| -FSO | Flexwelle in Sonderfarbe / Welle kürzen / Welle verlängern (auf max. 100 cm), Aufpreis flexible shaft in special color / to cut short / to extend (max. 100 cm), extra charge | +42,02 | +50,00 |

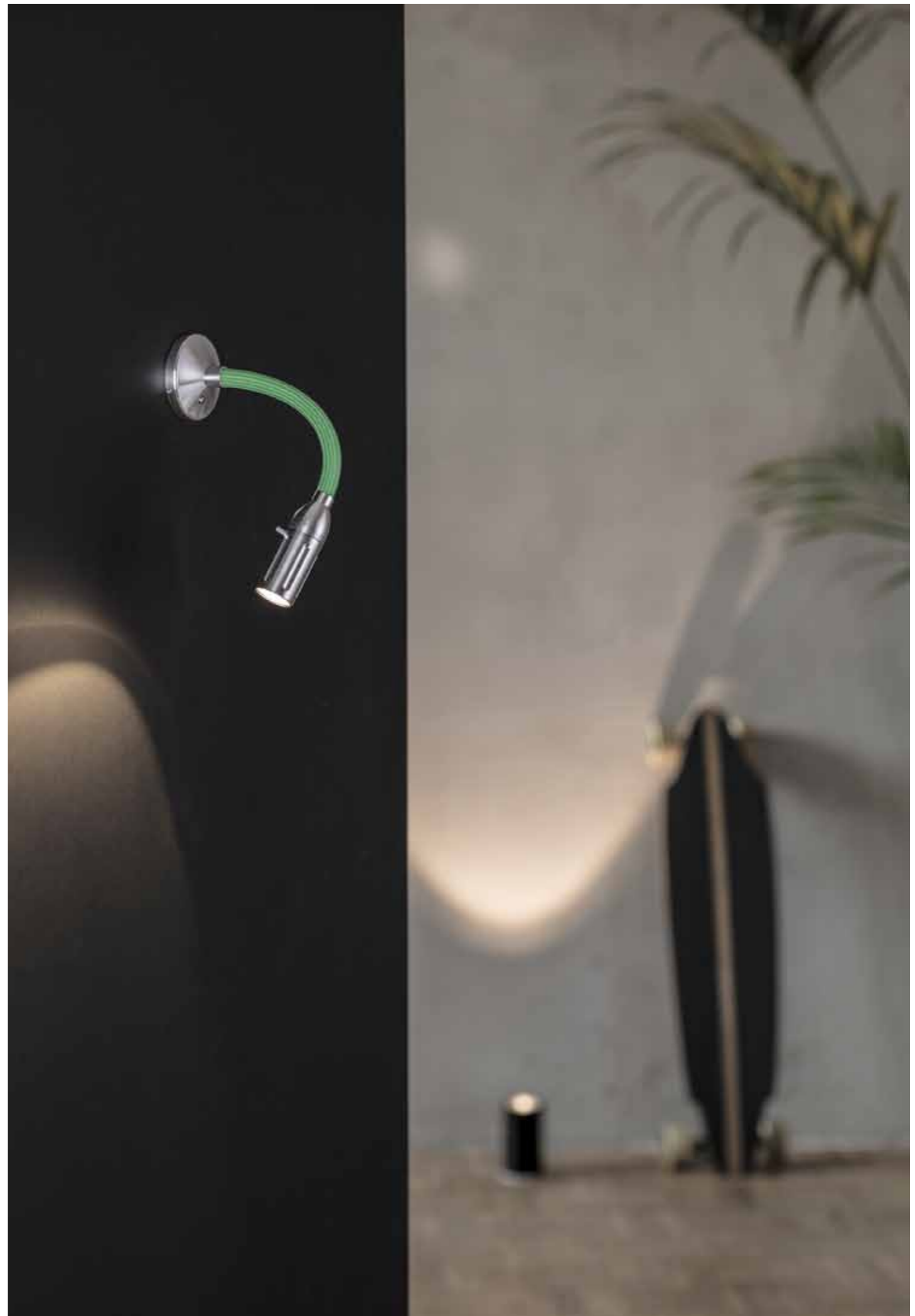
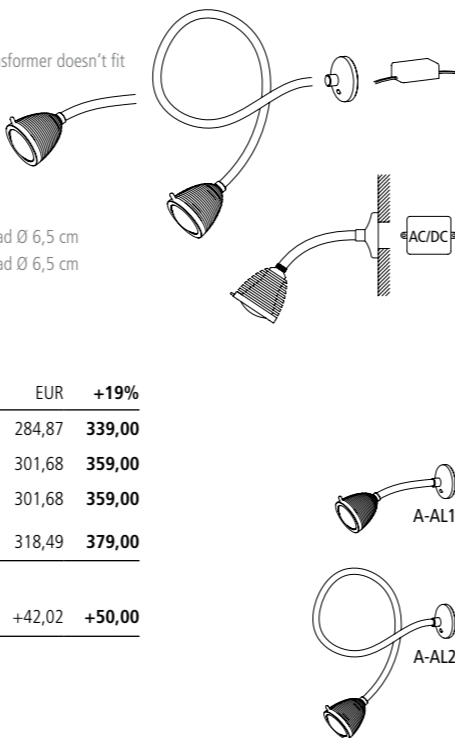

Z-EL



Typ

Einbauleuchte mit Leuchtkopf und Sockel aus massivem Aluminium /// 15–75° stufenlos einstellbarer Abstrahlwinkel durch Linsenoptik /// robuste Flexwelle mit gebürsteter Aluminiumoberfläche oder farbigem Textilüberzug

Montage

Netzteil außerhalb Sockel (nur von hinten montierbar, Netzteil passt nicht durch Montageöffnung), flächenbündiger Einbau möglich

Dimmung

wahlweise phasendimmbar oder mit Tastdimmer am Sockel

Abmessung

EL1: Länge bis 35 cm / Flexwelle 15 cm / Sockel Ø 6 cm / Kopf Ø 6,5 cm
EL2: Länge bis 65 cm / Flexwelle 45 cm / Sockel Ø 6 cm / Kopf Ø 6,5 cm

Lieferung

inkl. Netzteil

type

build-in light with lamp head and base made of solid aluminium /// lens optics with 15–75° infinitely focusable angle beam /// strong flexible shaft in brushed aluminium or colored textile coating

installation

transformer outside base (only backside installation, transformer doesn't fit through installation hole), flush-mounting possible

dimming

optional phase-cut dimming or with base dimmer switch

dimension

EL1: length up to 35 cm / flex 15 cm / base Ø 6 cm / head Ø 6,5 cm
EL2: length up to 65 cm / flex 45 cm / base Ø 6 cm / head Ø 6,5 cm

delivery

incl. transformer

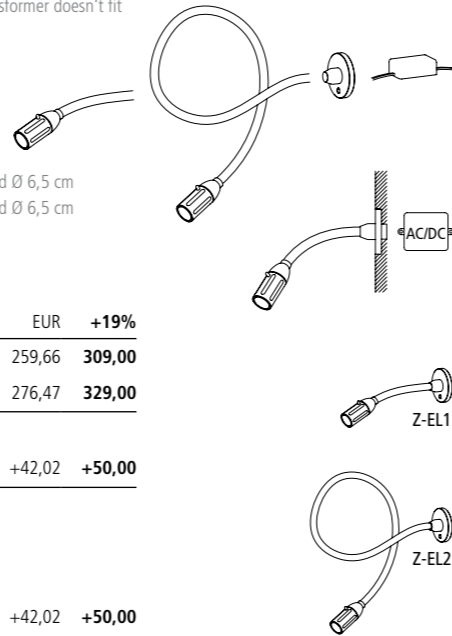

| | | EUR | +19% |
|---------|---|--------|--------|
| Z-EL1-S | Tastdimmer am Sockel base dimmer switch | 259,66 | 309,00 |
| Z-EL2-S | Tastdimmer am Sockel base dimmer switch | 276,47 | 329,00 |
| -KA | Kopf und Sockel in Alu head and base in alu | | |
| -KS | Kopf und Sockel in schwarz head and base in black | +42,02 | +50,00 |
| -FA | Flexwelle mit gebürsteter Aluminiumoberfläche flexible shaft in alu brush-finished | | |
| -FT... | Flexwelle Textil S = schwarz R = rot A = anthrazit W = weiß G = grün U = braun B = blau flexible shaft textile S = black R = red A = anthracite W = white G = green U = brown B = blue | | |
| -FSO | Flexwelle in Sonderfarbe / Welle kürzen / Welle verlängern (auf max. 100 cm), Aufpreis flexible shaft in special color / to cut short / to extend (max. 100 cm), extra charge | +42,02 | +50,00 |

A-EL



Typ

Einbauleuchte mit Leuchtkopf und Sockel aus massivem Aluminium /// 25–100° stufenlos einstellbarer Abstrahlwinkel durch Glaslinsenoptik /// robuste Flexwelle mit gebürsteter Aluminiumoberfläche oder farbigem Textilüberzug

Montage

Netzteil außerhalb Sockel (nur von hinten montierbar, Netzteil passt nicht durch Montageöffnung), flächenbündiger Einbau möglich

Dimmung

wahlweise phasendimmbar oder mit Tastdimmer am Sockel

Abmessung

EL1: Länge bis 35 cm / Flexwelle 15 cm / Sockel Ø 6 cm / Kopf Ø 6,5 cm
EL2: Länge bis 65 cm / Flexwelle 45 cm / Sockel Ø 6 cm / Kopf Ø 6,5 cm

Lieferung

inkl. Netzteil

type

build-in light with lamp head and base made of solid aluminium /// glass lens optics with 25–100° infinitely focusable angle beam /// strong flexible shaft in brushed aluminium or colored textile coating

installation

transformer outside base (only backside installation, transformer doesn't fit through installation hole), flush-mounting possible

dimming

optional phase-cut dimming or with base dimmer switch

dimension

EL1: length up to 35 cm / flex 15 cm / base Ø 6 cm / head Ø 6,5 cm
EL2: length up to 65 cm / flex 45 cm / base Ø 6 cm / head Ø 6,5 cm

delivery

incl. transformer

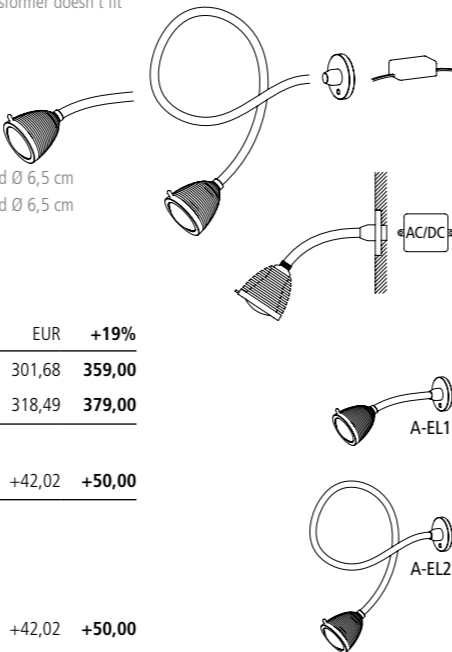

| | | EUR | +19% |
|---------|---|--------|--------|
| A-EL1-S | Tastdimmer am Sockel base dimmer switch | 301,68 | 359,00 |
| A-EL2-S | Tastdimmer am Sockel base dimmer switch | 318,49 | 379,00 |
| -KA | Kopf und Sockel in Alu head and base in alu | | |
| -KS | Kopf und Sockel in schwarz head and base in black | +42,02 | +50,00 |
| -FA | Flexwelle mit gebürsteter Aluminiumoberfläche flexible shaft in alu brush-finished | | |
| -FT... | Flexwelle Textil S = schwarz R = rot A = anthrazit W = weiß G = grün U = braun B = blau flexible shaft textile S = black R = red A = anthracite W = white G = green U = brown B = blue | | |
| -FSO | Flexwelle in Sonderfarbe / Welle kürzen / Welle verlängern (auf max. 100 cm), Aufpreis flexible shaft in special color / to cut short / to extend (max. 100 cm), extra charge | +42,02 | +50,00 |

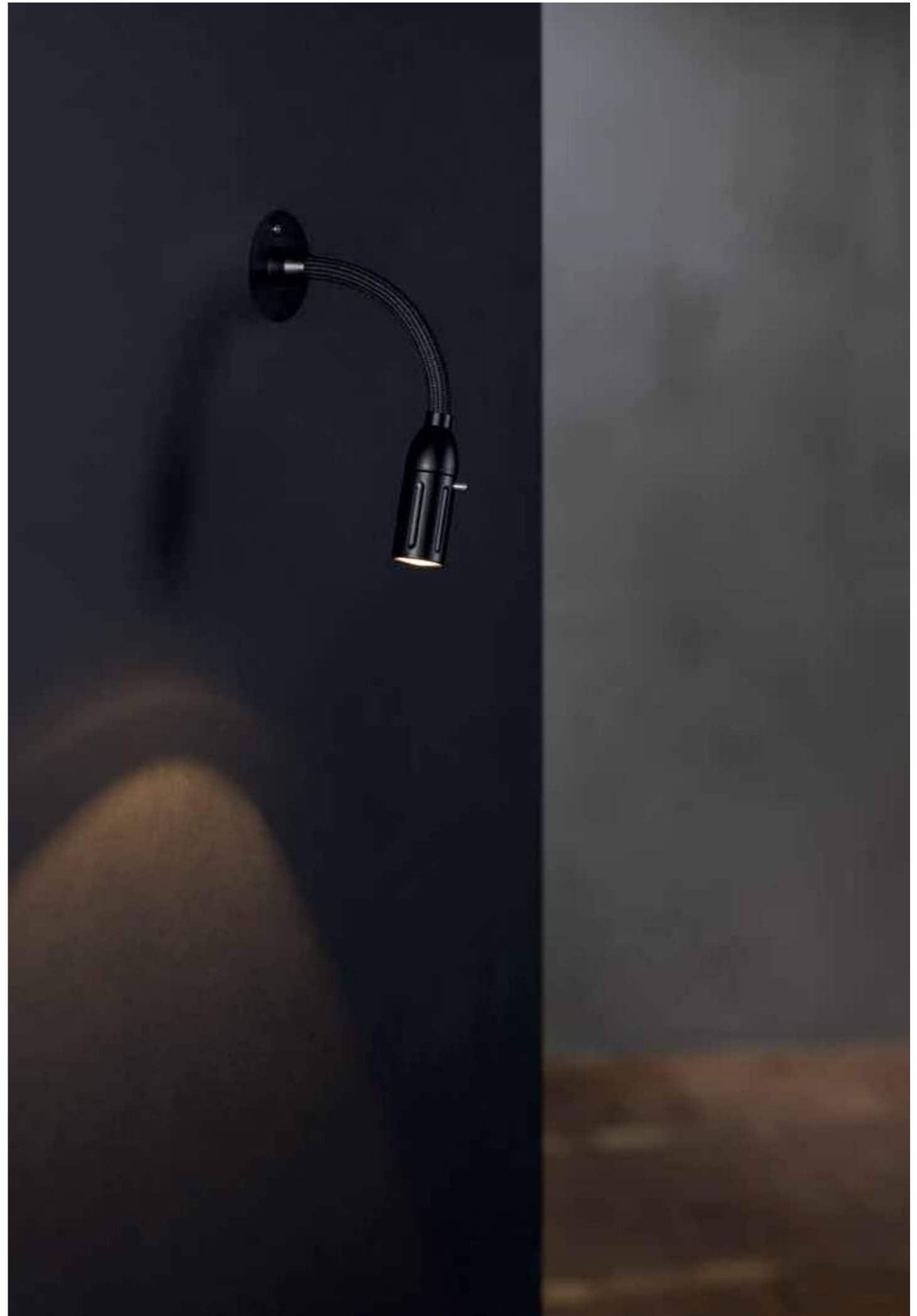

Z-MDL



Typ

Wand-/Deckenleuchte mit Leuchtkopf und Sockel aus massivem Aluminium
 /// 15–75° stufenlos einstellbarer Abstrahlwinkel durch Glaslinsenoptik
 /// robuste Flexwelle mit gebürsteter Aluminiumoberfläche oder farbigem Textilüberzug

type

wall/ceiling light with lamp head and base made of solid aluminium /// lens optics with 15–75° infinitely focusable angle beam /// strong flexible shaft in brushed aluminium or colored textile coating

Montage

Netzteil außerhalb Sockel /// Montage über Unterputzdose möglich

installation

transformer outside base /// flush-mounting installation possible

Dimmung

wahlweise phasendimmbar oder mit Tastdimmer am Sockel

dimming

optional phase-cut dimming or with base dimmer switch

Abmessung

MDL1: Länge bis 35 cm / Flexwelle 15 cm / Sockel Ø 10 cm / Kopf Ø 3 cm
 MDL2: Länge bis 65 cm / Flexwelle 45 cm / Sockel Ø 10 cm / Kopf Ø 3 cm

dimension

MDL1: length up to 35 cm / flex 15 cm / base Ø 10 cm / head Ø 3 cm
 MDL2: length up to 65 cm / flex 45 cm / base Ø 10 cm / head Ø 3 cm

Lieferung

inkl. Netzteil, Schrauben

delivery

incl. transformer, screws

| | | EUR | +19% |
|----------|---|--------|--------|
| Z-MDL1-P | phasendimmbar phase-cut dimming | 259,66 | 309,00 |
| Z-MDL1-S | Tastdimmer am Sockel base dimmer switch | 276,47 | 329,00 |
| Z-MDL2-P | phasendimmbar phase-cut dimming | 276,47 | 329,00 |
| Z-MDL2-S | Tastdimmer am Sockel base dimmer switch | 293,28 | 349,00 |
| -KA | Kopf und Sockel in Alu head and base in alu | | |
| -KS | Kopf und Sockel in schwarz head and base in black | +42,02 | +50,00 |
| -FA | Flexwelle mit gebürsteter Aluminiumoberfläche flexible shaft in alu brush-finished | | |
| -FT... | Flexwelle Textil S = schwarz R = rot A = anthrazit W = weiß G = grün U = braun B = blau flexible shaft textile S = black R = red A = anthracite W = white G = green U = brown B = blue | | |
| -FSO | Flexwelle in Sonderfarbe / Welle kürzen / Welle verlängern (auf max. 100 cm), Aufpreis flexible shaft in special color / to cut short / to extend (max. 100 cm), extra charge | +42,02 | +50,00 |

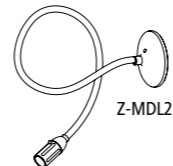
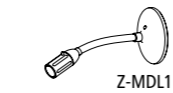
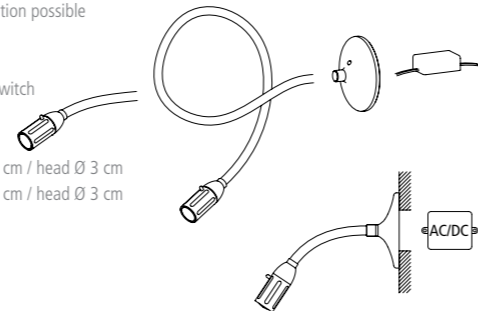

A-MDL



Typ

Wand-/Deckenleuchte mit Leuchtkopf und Sockel aus massivem Aluminium
 /// 25–100° stufenlos einstellbarer Abstrahlwinkel durch Glaslinsenoptik
 /// robuste Flexwelle mit gebürsteter Aluminiumoberfläche oder farbigem Textilüberzug

type

wall/ceiling light with lamp head and base made of solid aluminium /// glass lens optics with 25–100° infinitely focusable angle beam /// strong flexible shaft in brushed aluminium or colored textile coating

Montage

Netzteil außerhalb Sockel /// Montage über Unterputzdose möglich

installation

transformer outside base /// flush-mounting installation possible

Dimmung

wahlweise phasendimmbar oder mit Tastdimmer am Sockel

dimming

optional phase-cut dimming or with base dimmer switch

Abmessung

MDL1: Länge bis 35 cm / Flexwelle 15 cm / Sockel Ø 10 cm / Kopf Ø 6,5 cm
 MDL2: Länge bis 65 cm / Flexwelle 45 cm / Sockel Ø 10 cm / Kopf Ø 6,5 cm

dimension

MDL1: length up to 35 cm / flex 15 cm / base Ø 10 cm / head Ø 6,5 cm
 MDL2: length up to 65 cm / flex 45 cm / base Ø 10 cm / head Ø 6,5 cm

Lieferung

inkl. Netzteil, Schrauben

delivery

incl. transformer, screws

| | | EUR | +19% |
|----------|---|--------|--------|
| A-MDL1-P | phasendimmbar phase-cut dimming | 301,68 | 359,00 |
| A-MDL1-S | Tastdimmer am Sockel base dimmer switch | 318,49 | 379,00 |
| A-MDL2-P | phasendimmbar phase-cut dimming | 318,49 | 379,00 |
| A-MDL2-S | Tastdimmer am Sockel base dimmer switch | 335,29 | 399,00 |
| -KA | Kopf und Sockel in Alu head and base in alu | | |
| -KS | Kopf und Sockel in schwarz head and base in black | +42,02 | +50,00 |
| -FA | Flexwelle mit gebürsteter Aluminiumoberfläche flexible shaft in alu brush-finished | | |
| -FT... | Flexwelle Textil S = schwarz R = rot A = anthrazit W = weiß G = grün U = braun B = blau flexible shaft textile S = black R = red A = anthracite W = white G = green U = brown B = blue | | |
| -FSO | Flexwelle in Sonderfarbe / Welle kürzen / Welle verlängern (auf max. 100 cm), Aufpreis flexible shaft in special color / to cut short / to extend (max. 100 cm), extra charge | +42,02 | +50,00 |

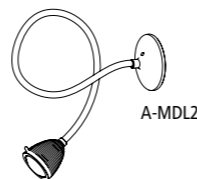
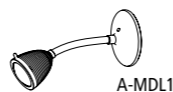
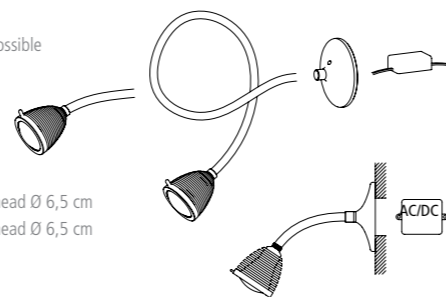

Z-WL



Typ

Wandleuchte mit Leuchtkopf und Rohr aus massivem Aluminium /// 15–75° stufenlos einstellbarer Abstrahlwinkel durch Linsenoptik /// robuste Flexwelle mit gebürsteter Aluminiumoberfläche oder farbigem Textilüberzug /// Wandhalterung aus satiniertem Edelstahl

type

wall light with lamp head and tube made of solid aluminium /// lens optics with 15–75° infinitely focusable angle beam /// strong flexible shaft in brushed aluminium or colored textile coating /// wall fitting made of satined stainless steel

Dimmung

Tastdimmer am Sockel

dimming

base dimmer switch

Abmessung

WL1: Höhe max. 65 cm / Flexwelle 45 cm / Kopf Ø 3 cm

dimension

WL1: height up to 65 cm / flex 45 cm / head Ø 3 cm

Lieferung

inkl. USB Steckernetzteil

delivery

incl. USB plug transformer

| | | EUR | +19% |
|-----------------------|---|--------|---------------|
| Z-WL1 | | 276,47 | 329,00 |
| -KA | Kopf und Rohr in Alu head and tube in alu | | |
| -KS | Kopf und Rohr in schwarz head and tube in black | +42,02 | +50,00 |
| -FA | Flexwelle mit gebürsteter Aluminiumoberfläche flexible shaft in alu brush-finished | | |
| -FT... | Flexwelle Textil S = schwarz R = rot A = anthrazit W = weiß G = grün U = braun B = blau flexible shaft textile S = black R = red A = anthracite W = white G = green U = brown B = blue | | |
| -FSO | Flexwelle in Sonderfarbe / Welle kürzen / Welle verlängern (auf max. 100 cm), Aufpreis flexible shaft in special color / to cut short / to extend (max. 100 cm), extra charge | +42,02 | +50,00 |
| Z-WL1 -KA -FTA | BESTSELLER – Versandfertig innerhalb von 3 Werktagen* ready for delivery within 3 weekdays* | 276,47 | 329,00 |

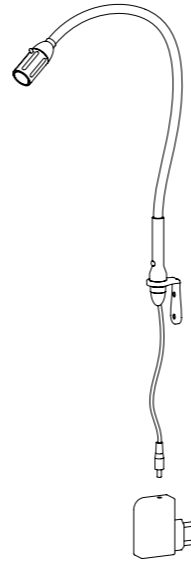

A-WL



Typ

Wandleuchte mit Leuchtkopf und Rohr aus massivem Aluminium /// 25–100° stufenlos einstellbarer Abstrahlwinkel durch Glaslinsenoptik /// robuste Flexwelle mit gebürsteter Aluminiumoberfläche oder farbigem Textilüberzug /// Wandhalterung aus satiniertem Edelstahl

type

wall light with lamp head and tube made of solid aluminium /// glass lens optics with 25–100° infinitely focusable angle beam /// strong flexible shaft in brushed aluminium or colored textile coating /// wall fitting made of satined stainless steel

Dimmung

Tastdimmer am Sockel

dimming

base dimmer switch

Abmessung

WL1: Höhe max. 65 cm / Flexwelle 45 cm / Kopf Ø 6,5 cm

WL2: Höhe max. 85 cm / Flexwelle 45 cm / Kopf Ø 6,5 cm

dimension

WL1: height up to 65 cm / flex 45 cm / head Ø 6,5 cm

WL2: height up to 85 cm / flex 45 cm / head Ø 6,5 cm

Lieferung

inkl. USB Steckernetzteil

delivery

incl. USB plug transformer

| | | EUR | +19% |
|-----------------------|---|--------|---------------|
| A-WL1 | | 318,49 | 379,00 |
| A-WL2 | | 343,70 | 409,00 |
| -KA | Kopf und Rohr in Alu head and tube in alu | | |
| -KS | Kopf und Rohr in schwarz head and tube in black | +42,02 | +50,00 |
| -FA | Flexwelle mit gebürsteter Aluminiumoberfläche flexible shaft in alu brush-finished | | |
| -FT... | Flexwelle Textil S = schwarz R = rot A = anthrazit W = weiß G = grün U = braun B = blau flexible shaft textile S = black R = red A = anthracite W = white G = green U = brown B = blue | | |
| -FSO | Flexwelle in Sonderfarbe / Welle kürzen / Welle verlängern (auf max. 100 cm), Aufpreis flexible shaft in special color / to cut short / to extend (max. 100 cm), extra charge | +42,02 | +50,00 |
| A-WL1 -KA -FTA | BESTSELLER – Versandfertig innerhalb von 3 Werktagen* ready for delivery within 3 weekdays* | 318,49 | 379,00 |
| A-WL1 -KA -FTR | BESTSELLER – Versandfertig innerhalb von 3 Werktagen* ready for delivery within 3 weekdays* | 318,49 | 379,00 |

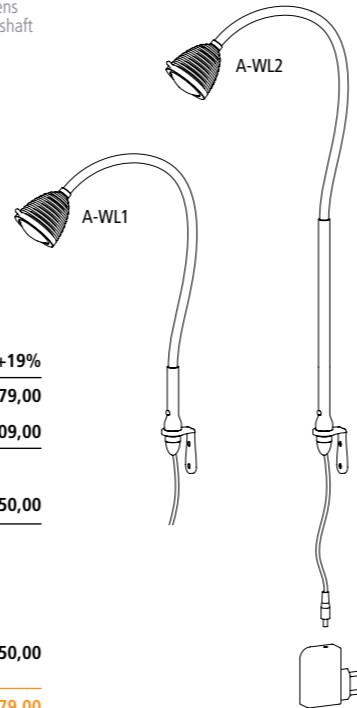

A-HWL



Typ

Wandleuchte mit Leuchtkopf aus massivem Aluminium /// 25–100° stufenlos einstellbarer Abstrahlwinkel durch Glaslinsenoptik /// ausziehbare Flexwelle mit gebürsteter Aluminiumoberfläche /// Rohr aus massivem Eichenholz /// Wandhalter aus satiniertem Edelstahl

Dimmung

Handdimmer

Abmessung

Höhe max. 100 cm / Flexwelle 35 cm / Kopf Ø 6,5 cm

Lieferung

inkl. Steckernetzteil mit rot / weiß kariertem Textilleitung

type

wall light with lamp head made of solid aluminium /// glass lens optics with 25–100° infinitely focusable angle beam /// extendible flexible shaft in brushed aluminium /// solid oak wood tube /// wall fitting satined stainless steel

dimming

hand dimmer switch

dimension

height max. 100 cm / flex 35 cm / head Ø 6,5 cm

delivery

incl. plug transformer with red / white checkered textile lead

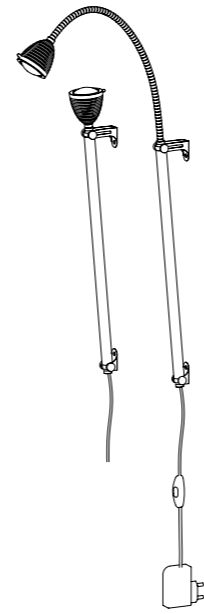

EUR +19%

A-HWL

377,31 449,00

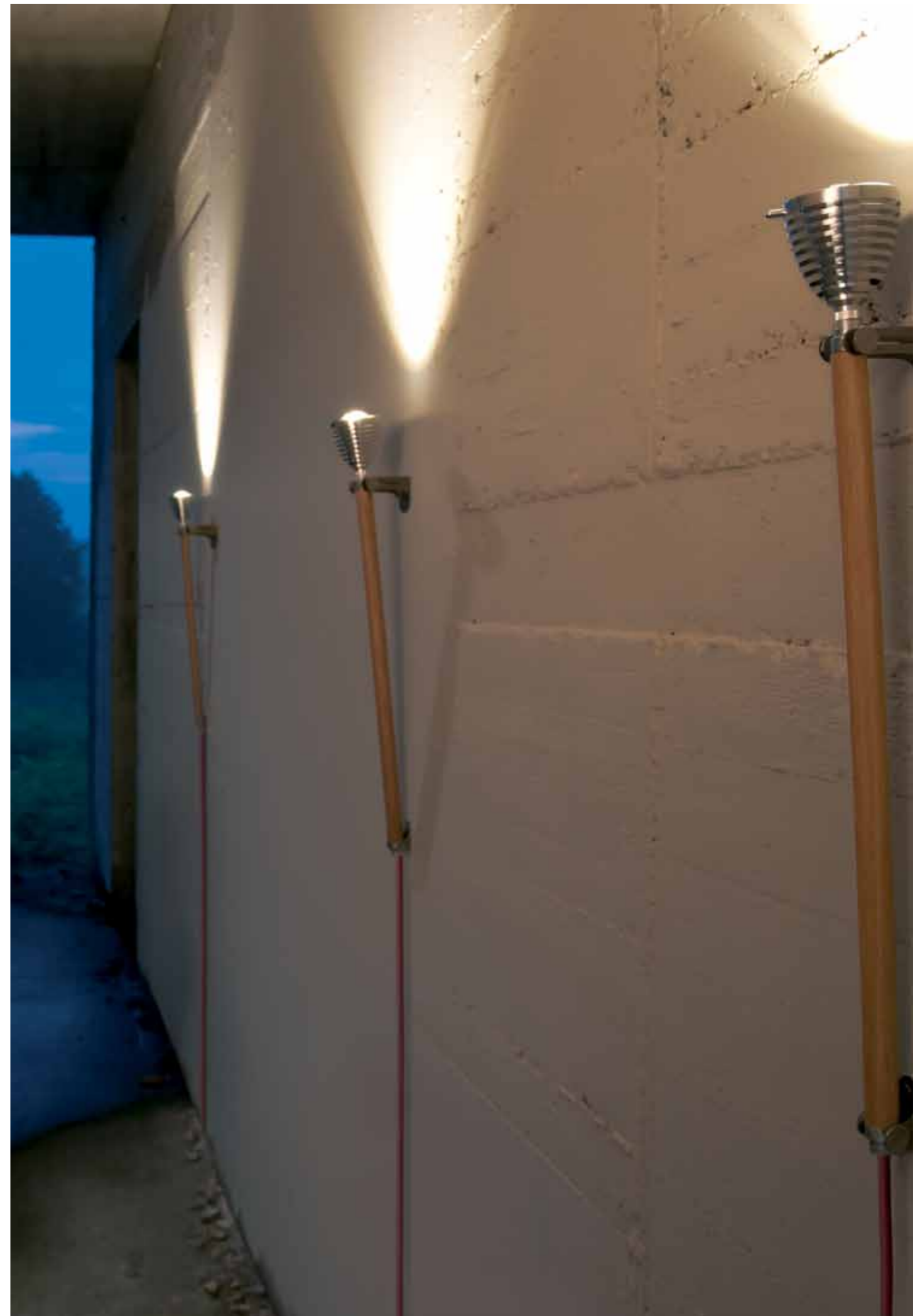

A-2WS



Typ

Doppelter Wandstrahler aus massivem Aluminium /// 40–100° stufenlos einstellbarer Abstrahlwinkel durch Glaslinsenoptik

type

double wall spotlight with lamp head and base made of solid aluminium /// glass lens optics with 40–100° infinitely focusable angle beam

Montage

Netzteil innerhalb Strahler

installation

transformer inside base

Dimmung

phasendimmbar

dimming

phase-cut dimming

Abmessung

Höhe 24 cm / Sockel Ø 6 cm / Kopf Ø 7 cm

dimension

height 24 cm / base Ø 6 cm / head Ø 7 cm

Lieferung

inkl. Netzteil, Schrauben

delivery

incl. transformer, screws

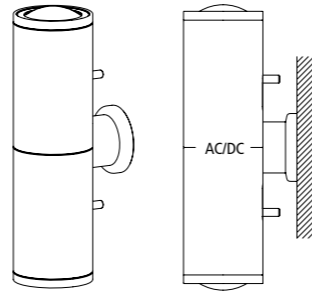

EUR +19%

A-2WS 419,33 499,00

-K... Korpus in P = poliert S = schwarz W = weiß G = gold corpus in P = polished S = black W = white G = gold

-S... Sockel und Kopf P = poliert S = schwarz W = weiß G = gold base and head P = polished S = black W = white G = gold

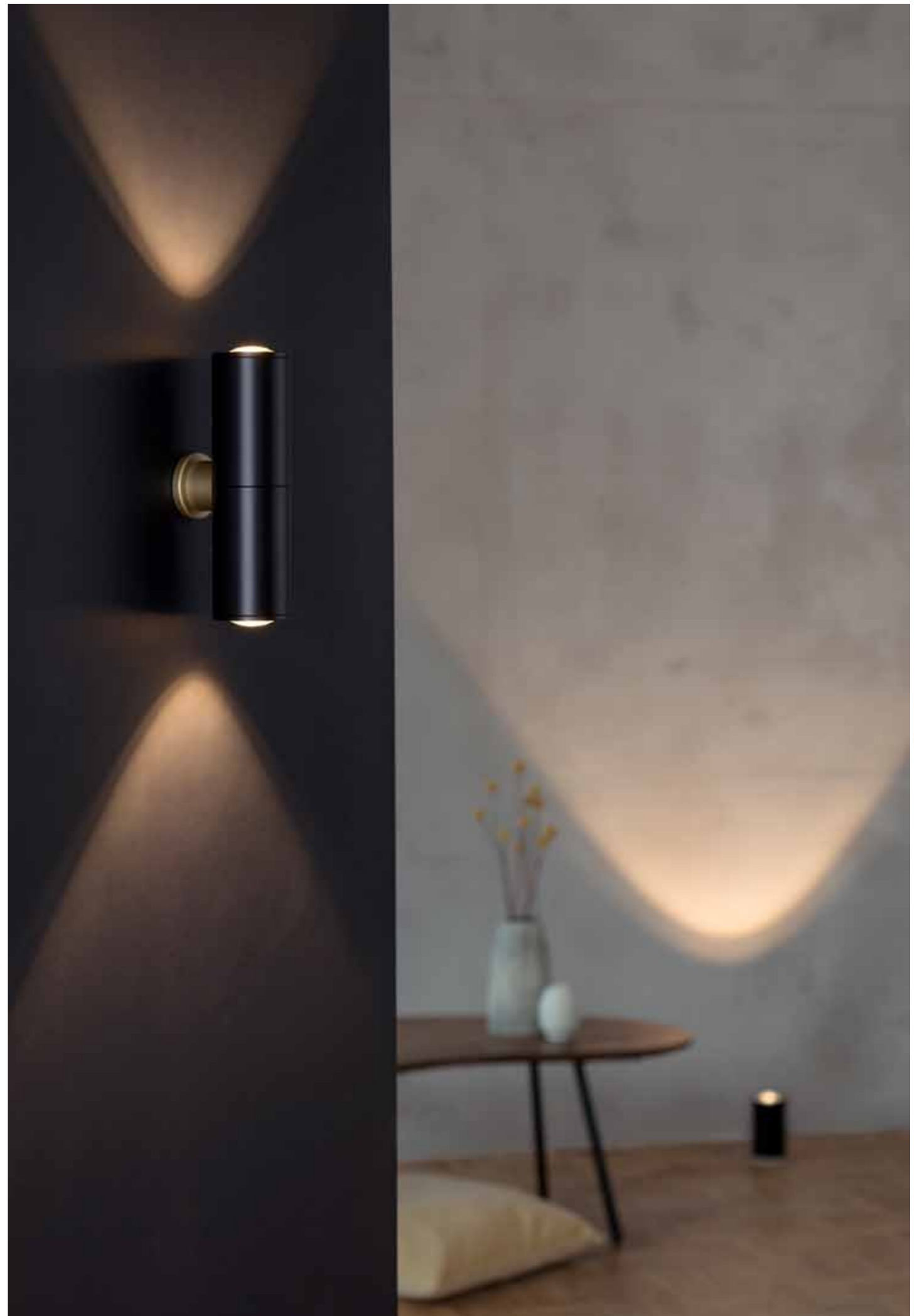

Y-BDS



Typ

Wand- / Deckenstrahler mit Leuchtkopf aus massivem Aluminium /// 50–100° stufenlos einstellbarer Abstrahlwinkel durch Glaslinsenoptik /// Sockel aus poliertem Beton

type

wall/ceiling light with lamp head made of solid aluminium /// glass lens optics with 50–100° infinitely focusable angle beam /// base made of polished concrete

Dimmung

wahlweise phasendimmbar / Drehdimmer am Leuchtkopf / DALI

dimming

optional phase-cut dimming / rotary dimmer switch / DALI

Montage

Netzteil innerhalb Sockel /// Montage über Unterputzdose möglich

installation

transformer inside base /// flush-mounting installation possible

Abmessung

Höhe 20 cm / Kopf Ø 9 cm / Sockel Ø 15 cm

dimension

height 20 cm / head Ø 9 cm / base Ø 15 cm

Lieferung

inkl. Netzteil, Schrauben

delivery

incl. transformer, screws

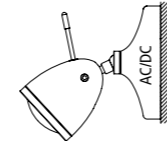
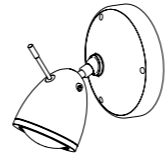

| | | EUR | +19% |
|-----------------|---|--------|--------|
| Y-BDS-P | phasendimmbar phase-cut dimming | 419,33 | 499,00 |
| Y-BDS-S | Drehdimmer am Leuchtkopf rotary lamp-head dimmer | 419,33 | 499,00 |
| Y-BDS-D | DALI | 419,33 | 499,00 |
| -K... | Kopf in P = poliert SM = schwarz matt SG = schwarz glanz WM = weiß matt WG = weiß glanz head in P = polished SM = black matt SG = black glossy WM = white matt WG = white glossy | | |
| -S... | Sockel in Beton G = grau W = weiß base in concrete G = grey W = white | | |
| Y-BDS-P -KWG-SW | BESTSELLER – Versandfertig innerhalb von 3 Werktagen* ready for delivery within 3 weekdays* | 419,33 | 499,00 |

Y-MDS



Typ

Wand- / Deckenstrahler mit Leuchtkopf und Sockel aus massivem Aluminium /// 50–100° stufenlos einstellbarer Abstrahlwinkel durch Glaslinsenoptik

type

wall/ceiling light with lamp head and base made of massive aluminium /// glass lens optics with 50–100° infinitely focusable angle beam

Dimmung

wahlweise phasendimmbar / Drehdimmer am Leuchtkopf / DALI

dimming

optional phase-cut dimming / rotary dimmer switch / DALI

Montage

Netzteil außerhalb Sockel /// Montage über Unterputzdose möglich

installation

transformer outside base /// flush-mounting installation possible

Abmessung

Höhe 20 cm / Kopf Ø 9 cm / Sockel Ø 10 cm

dimension

height 20 cm / head Ø 9 cm / base Ø 10 cm

Lieferung

inkl. Netzteil, Schrauben

delivery

incl. transformer, screws

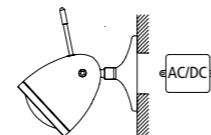
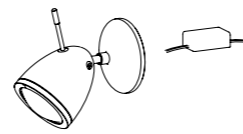

| | | EUR | +19% |
|---------|---|---------|---------|
| Y-MDS-P | phasendimmbar phase-cut dimming | 419,33 | 499,00 |
| Y-MDS-S | Drehdimmer am Leuchtkopf rotary lamp-head dimmer | 419,33 | 499,00 |
| Y-MDS-D | DALI | 419,33 | 499,00 |
| -K... | Kopf in P = poliert SM = schwarz matt SG = schwarz glanz WM = weiß matt WG = weiß glanz head in P = polished SM = black SG = black glossy WM = white WG = white glossy | | |
| -SA | Sockel in Alu base in alu | | |
| -SSO | Sockel in Sonderfarbe base in special color | +126,05 | +150,00 |



M-BWS1



Typ

Wandstrahler aus poliertem Beton mit Leuchtkopf aus massivem Aluminium /// 100° Abstrahlwinkel mit Glaslinsenoptik /// optional dim2warm LED auf Anfrage

Dimmung

phasendimmbar

Abmessung

L9 x B9 x H3,5 cm

Lieferung

inkl. LED Überspannungsschutzmodul, Schrauben

type

wall spotlight with polished concrete base and lamp head made of solid aluminium /// glass lens optics with 100° angle beam /// optional dim2warm LED on demand

dimming

phase-cut dimming

dimension

L9 x W9 x H3,5 cm

delivery

incl. LED power protection, screws

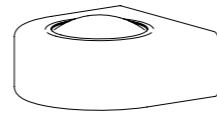

EUR +19%

M-BWS1 167,23 **199,00**

-B... Korpus in Beton **G** = grau **W** = weiß corpus in concrete **G** = grey **W** = white

M-BWS2



Typ

Doppel Wandstrahler aus poliertem Beton mit Leuchtkopf aus massivem Aluminium /// 100° Abstrahlwinkel mit Glaslinsenoptik /// optional dim2warm LED auf Anfrage

Dimmung

phasendimmbar

Abmessung

L9 x B9 x H5 cm

Lieferung

inkl. LED Überspannungsschutzmodul, Schrauben

type

double wall spotlight with polished concrete base and lamp head made of solid aluminium /// glass lens optics with 100° angle beam /// optional dim2warm LED on demand

dimming

phase-cut dimming

dimension

L9 x W9 x H5 cm

delivery

incl. LED power protection, screws

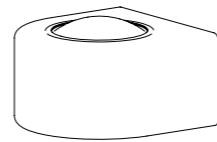

EUR +19%

M-BWS2 251,26 **299,00**

-B... Korpus in Beton **G** = grau **W** = weiß corpus in concrete **G** = grey **W** = white

M-BWS2 -SG **BESTSELLER – Versandfertig innerhalb von 3 Werktagen* ready for delivery within 3 weekdays*** 251,26 **299,00**



M-BAS



| | |
|---|--|
| Typ Aufbaustrahler aus poliertem Beton mit Leuchtkopf aus massivem Aluminium /// 100° Abstrahlwinkel mit Glaslinsenoptik /// optional dim2warm LED auf Anfrage | type build up spotlight with polished concrete base and lamp head made of solid aluminium /// glass lens optics with 100° angle beam /// optional dim2warm LED on demand |
| Dimmung phasendimmbar | dimming phase-cut dimming |
| Abmessung Korpus Ø 14 x 7,5 cm / Kopf Ø 6 cm | dimension corpus Ø 14 x 7,5 cm / head Ø 6 cm |
| Lieferung inkl. LED Überspannungsschutzmodul, Schrauben | delivery incl. LED power protection, screws |

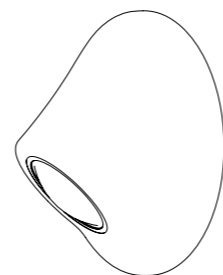

| | | |
|--|--------|---------------|
| | EUR | +19% |
| M-BAS | 167,23 | 199,00 |
| -B... Korpus in Beton G = grau W = weiß corpus in concrete G = grey W = white | | |

M-BUS



| | |
|---|--|
| Typ Wandeinbaustrahler aus poliertem Beton mit Leuchtkopf aus massivem Aluminium /// 100° Abstrahlwinkel mit Glaslinsenoptik /// optional dim2warm LED auf Anfrage | type build-in spotlight with polished concrete base and lamp head made of solid aluminium /// glass lens optics with 100° angle beam /// optional dim2warm LED on demand |
| Dimmung phasendimmbar | dimming phase-cut dimming |
| Montage Aufputz oder rahmenlos | installation caparison or frameless |
| Abmessung Korpus Ø 14 x 6,5 cm / Kopf Ø 6 cm / Einbautiefe max. 7 cm | dimension corpus Ø 14 x 6,5 cm / head Ø 6 cm / build-in depth max. 7 cm |
| Lieferung inkl. LED Überspannungsschutzmodul, Schrauben | delivery incl. LED power protection, screws |

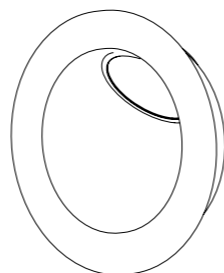

| | | |
|--|--------|---------------|
| | EUR | +19% |
| M-BUS | 167,23 | 199,00 |
| -B... Korpus in Beton G = grau W = weiß corpus in concrete G = grey W = white | | |
| BUS-MON Montageblech zum rahmenlosen Einbau in Hohlraumwand mounting plate for sunk cavity wall installation | 8,40 | 10,00 |



M-ES



Typ

Deckeneinbaustrahler aus massivem Aluminium /// 100° Abstrahlwinkel mit Glaslinsenoptik /// optional dim2warm LED auf Anfrage

Dimmung

phasendimmbar

Abmessung

ES-68: Kopf Ø 6,8 cm / Einbautiefe max. 5 cm
ES-80: Kopf Ø 8 cm / Einbautiefe max. 5 cm

Lieferung

inkl. LED Überspannungsschutzmodul, Befestigungsbügel

type

downlight made of solid aluminium /// glass lens optics with 100° angle beam /// optional dim2warm LED on demand

dimming

phase-cut dimming

dimension

ES-68: head Ø 6,8 cm / build-in depth max. 5 cm
ES-80: head Ø 8 cm / build-in depth max. 5 cm

delivery

incl. LED power protection, installation clamps



| | EUR | +19% |
|---------|---|-------|
| M-ES-68 | 74,79 | 89,00 |
| M-ES-80 | 83,19 | 99,00 |
| -K... | Strahler in A = Aluminium W = weiß downlight in A = aluminium W = white | |

M-BES



Typ

Deckeneinbaustrahler aus poliertem Beton mit Leuchtkopf aus massivem Aluminium /// 100° Abstrahlwinkel mit Glaslinsenoptik /// optional dim2warm LED auf Anfrage

Dimmung

phasendimmbar

Montage

Aufputz, kein Netzteil erforderlich

Abmessung

Korpus Ø 10 x 6,5 cm / Kopf Ø 6 cm / Einbautiefe max. 11 cm

Lieferung

inkl. LED Überspannungsschutzmodul, Befestigungsbügel

type

downlight with polished concrete base and lamp head made of solid aluminium /// glass lens optics with 100° angle beam /// optional dim2warm LED on demand

dimming

phase-cut dimming

installation

caparison, no transformer needed

dimension

corpus Ø 10 x 6,5 cm / head Ø 6 cm / build-in depth max. 11 cm

delivery

incl. LED power protection, installation clamps

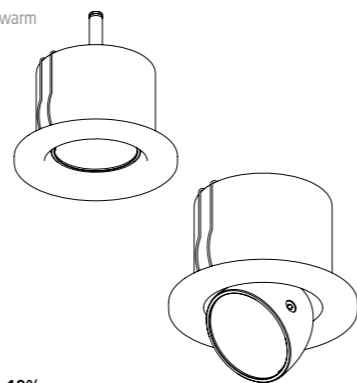

| | EUR | +19% |
|---------|---|--------|
| M-BES | 192,44 | 229,00 |
| -K... | Strahler in A = Aluminium W = weiß downlight in A = aluminium W = white | |
| -B... | Korpus in Beton G = grau W = weiß corpus in concrete G = grey W = white | |
| BES-MON | 8,40 | 10,00 |
| | Montageblech zum rahmenlosen Einbau in Hohlraumwand mounting plate for sunk cavity wall installation | |

Y-ES



Typ

Einbaustrahler aus massivem Aluminium /// 50–100° stufenlos einstellbarer Abstrahlwinkel durch Glaslinsenoptik /// Leuchtkopf 150° drehbar, 0–60° schwenkbar

Dimmung

wahlweise phasendimmbar / Drehdimmer am Leuchtkopf / DALI

Montage

Netzteil außerhalb Sockel /// Montage in Ø 13 cm Ausschnitt

Abmessung

Einbautiefe max. 8,5 cm / Kopf Ø 9 cm / Ring Ø 15 cm

Lieferung

inkl. Netzteil

type

downlight made of solid aluminium /// glass lens optics with 50–100° infinitely focusable angle beam /// lamp head 150° twistable, 0–60° turnable

dimming

optional phase-cut dimming / rotary dimmer switch / DALI

installation

transformer outside base /// installation in Ø 13 cm cut-out

dimension

build-in depth max. 8,5 cm / head Ø 9 cm / ring Ø 15 cm

delivery

incl. transformer

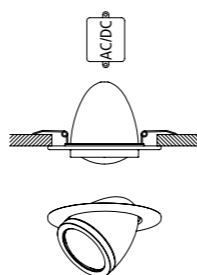

| | EUR | +19% |
|--------|--|--------|
| Y-ES-P | 377,31 | 449,00 |
| Y-ES-D | 377,31 | 449,00 |
| -K... | Kopf in P = poliert S = schwarz matt W = weiß matt head in P = polished S = black matt W = white matt | |



A-3DL



Typ

Dreier Deckenleuchte mit Leuchtköpfen aus massivem Aluminium und weißem Porzellansockel /// 25–100° stufenlos einstellbarer Abstrahlwinkel durch Glaslinsoptik /// robuste Flexwellen mit gebürsteter Aluminiumoberfläche oder farbigem Textilüberzug

type

triple ceiling light with lamp heads made of solid aluminium and white porcelain base /// glass lens optics with 25–100° infinitely focusable angle beam /// strong flexible shafts in brushed aluminium or colored textile coating

Montage

Netzteil innerhalb Sockel

installation

transformer inside base

Dimmung

wahlweise phasendimmbar / 1–10 V / PUSH / DALI

dimming

optional phase-cut dimming / 1–10 V / PUSH / DALI

Abmessung

Höhe max. 85 cm / Flexwelle 65 cm / Kopf Ø 6,5 cm / Sockel Ø 13 cm

dimension

height max. 85 cm / flex 65 cm / head Ø 6,5 cm / base Ø 13 cm

Lieferung

inkl. Netzteil, Schrauben

delivery

incl. transformer, screws

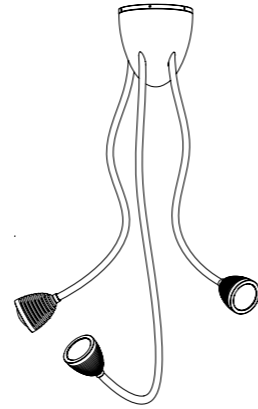

| | | EUR | +19% |
|---------|---|--------|----------|
| A-3DL-P | phasendimmbar phase-cut dimming | 923,53 | 1.099,00 |
| A-3DL-S | 1–10 V / PUSH | 923,53 | 1.099,00 |
| A-3DL-D | DALI | 923,53 | 1.099,00 |
| -KA | Köpfe in Alu heads in alu | | |
| -KS | Köpfe in schwarz heads in black | +63,02 | +75,00 |
| -FA | Flexwelle mit gebürsteter Aluminiumoberfläche flexible shaft in alu brush-finished | | |
| -FT... | Flexwelle Textil S = schwarz R = rot A = anthrazit W = weiß G = grün U = braun B = blau flexible shaft textile S = black R = red A = anthracite W = white G = green U = brown B = blue | | |
| -FSO | Flexwellen in Sonderfarbe, Aufpreis flexible shafts in special color, extra charge | +63,02 | +75,00 |

A-6DL



Typ

Sechser Deckenleuchte mit Leuchtköpfen aus massivem Aluminium und weißem Porzellansockel /// 25–100° stufenlos einstellbarer Abstrahlwinkel durch Glaslinsoptik /// robuste Flexwellen mit gebürsteter Aluminiumoberfläche oder farbigem Textilüberzug

type

six ceiling light with lamp heads made of solid aluminium and white porcelain base /// glass lens optics with 25–100° infinitely focusable angle beam /// strong flexible shafts in brushed aluminium or colored textile coating

Montage

Netzteil innerhalb Sockel

installation

transformer inside base

Dimmung

wahlweise phasendimmbar / 1–10 V / PUSH / DALI

dimming

optional phase-cut dimming / 1–10 V / PUSH / DALI

Abmessung

Höhe max. 110 cm / Flexwelle 90 cm / Kopf Ø 6,5 cm / Sockel Ø 13 cm

dimension

height max. 110 cm / flex 90 cm / head Ø 6,5 cm / base Ø 13 cm

Lieferung

inkl. 2x Netzteil, Schrauben

delivery

incl. 2x transformer, screws

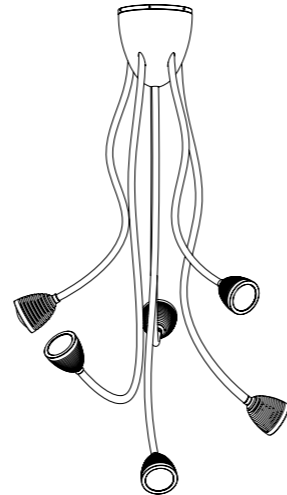

| | | EUR | +19% |
|---------|---|----------|----------|
| A-6DL-P | phasendimmbar phase-cut dimming | 1.679,83 | 1.999,00 |
| A-6DL-S | 1–10 V / PUSH | 1.679,83 | 1.999,00 |
| A-6DL-D | DALI | 1.679,83 | 1.999,00 |
| -KA | Köpfe in Alu heads in alu | | |
| -KS | Köpfe in schwarz heads in black | +126,05 | +150,00 |
| -FA | Flexwelle mit gebürsteter Aluminiumoberfläche flexible shaft in alu brush-finished | | |
| -FT... | Flexwelle Textil S = schwarz R = rot A = anthrazit W = weiß G = grün U = braun B = blau flexible shaft textile S = black R = red A = anthracite W = white G = green U = brown B = blue | | |
| -FSO | Flexwellen in Sonderfarbe, Aufpreis flexible shafts in special color, extra charge | +126,05 | +150,00 |



Y-BDL



Typ

Wand-/Deckenleuchte mit Leuchtkopf und Teleskoprohr aus massivem Aluminium /// 50–100° stufenlos einstellbarer Abstrahlwinkel durch Glaslin-senoptik /// längenverstellbares Teleskoprohr mit Lederschleife /// Sockel aus poliertem Beton

Dimmung

wahlweise phasendimmbar / Drehdimmer am Leuchtkopf / DALI

Montage

Netzteil innerhalb Sockel /// Montage über Unterputzdose möglich

Abmessung

Länge max. 140 cm / Teleskop 75–140 cm / Kopf Ø 9 cm / Sockel Ø 15 cm

Lieferung

inkl. Netzteil, Schrauben

type

wall/ceiling light with lamp head and telescope tube made of solid alumi-nium /// glass lens optics with 50–100° infinitely focusable angle beam /// length adjustable telescope tube with leather loop /// base made of polished concrete

dimming

optional phase-cut dimming / rotary dimmer switch / DALI

installation

transformer inside base /// flush-mounting installation possible

dimension

height max. 140 cm / telescope 75–140 cm / head Ø 9 cm / stand Ø 15 cm

delivery

incl. transformer, screws

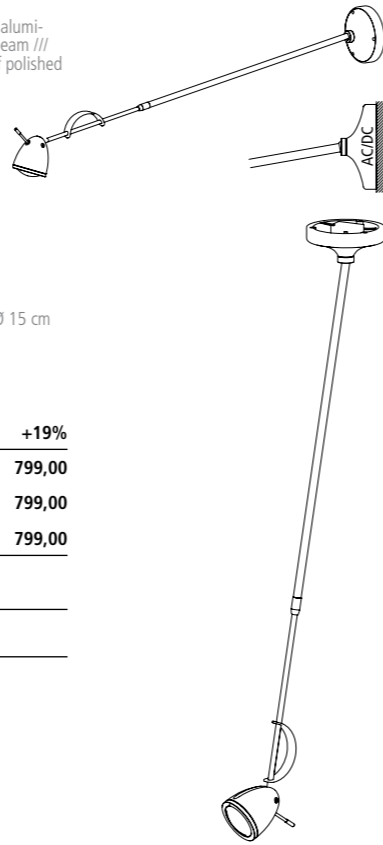

| | | EUR | +19% |
|---------|---|--------|--------|
| Y-BDL-P | phasendimmbar phase-cut dimming | 671,43 | 799,00 |
| Y-BDL-S | Drehdimmer am Leuchtkopf rotary lamp-head dimmer | 671,43 | 799,00 |
| Y-BDL-D | DALI | 671,43 | 799,00 |
| -K... | Kopf in P = poliert SM = schwarz matt SG = schwarz glanz WM = weiß matt WG = weiß glanz head in P = polished SM = black SG = black glossy WM = white WG = white glossy | | |
| -S... | Sockel in Beton G = grau W = weiß standing in concrete G = grey W = white | | |



A-BPL



Typ

Pendelleuchte mit Leuchtkopf und Sockel aus massivem Aluminium /// 25–100° stufenlos einstellbarer Abstrahlwinkel durch Glaslinsenoptik /// flexible Pendelleitung mit farbigem Textilüberzug

type

pendant light with lamp head and base made of solid aluminium /// glass lens optics with 25–100° infinitely focusable angle beam /// flexible pendant lead with colored textile coating

Montage

Netzteil innerhalb Sockel /// Montage über Unterputzdose optional mit Adapterteller möglich /// Montage mehrerer Leuchten in Reihe durch Verbindungswellen möglich

installation

transformer inside base /// optional flush-mounting installation by counting plate /// row connection of several lights with connecting shafts possible

Dimmung

phasendimmbar

dimming

phase-cut dimming

Abmessung

Pendel max. 300 cm / Sockel Ø 6,5 cm / Kopf Ø 6,5 cm

dimension

pendant max. 300 cm / base Ø 6,5 cm / head Ø 6,5 cm

Lieferung

inkl. Netzteil, Schrauben

delivery

incl. transformer, screws

| | | EUR | +19% |
|----------------|---|--------|---------------|
| A-BPL-P | | 293,28 | 349,00 |
| -KA | Kopf und Sockel in Alu head and base in alu | | |
| -KS | Kopf und Sockel in schwarz head and base in black | +42,02 | +50,00 |
| -PT... | Pendelkabel Textil S = schwarz R = rot W = weiß pendant lead textile S = black R = red W = white | | |
| -PSO | Pendelkabel Textil Sonderfarbe Aufpreis je Pendel (300 cm) pendant lead textile special color additional charge each pendant (300 cm) | +42,02 | +50,00 |
| FS-050 | 50 cm Verbindungswelle 230V 50 cm connecting shaft 230V | 42,02 | 50,00 |
| FS-100 | 100 cm Verbindungswelle 100 cm connecting shaft | 63,02 | 75,00 |
| FS-150 | 150 cm Verbindungswelle 230V 150 cm connecting shaft 230V | 84,03 | 100,00 |
| MB-100 | Montageteller Ø 10 cm (zur Montage über Unterputzdose) counting plate Ø 10 cm (for flush-mounting installation) | 33,61 | 40,00 |
| SO-065x35 | Sockel zur externen Stromspeisung in Verbindungswelle base for external power supply in connecting shaft | 50,42 | 60,00 |

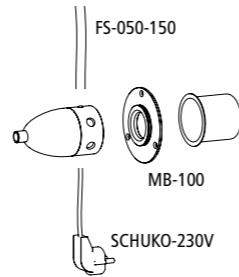
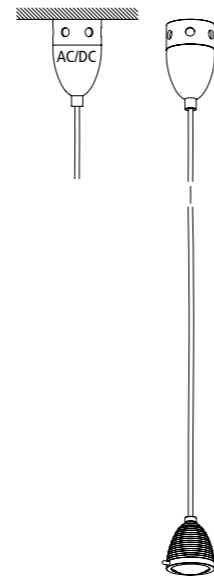

A-MPL



Typ

Pendelleuchte mit Leuchtkopf und Sockel aus massivem Aluminium /// 25–100° stufenlos einstellbarer Abstrahlwinkel durch Glaslinsenoptik /// flexible Pendelleitung mit farbigem Textilüberzug

type

pendant light with lamp head and base made of solid aluminium /// glass lens optics with 25–100° infinitely focusable angle beam /// flexible pendant lead with colored textile coating

Montage

Netzteil außerhalb Sockel /// Montage über Unterputzdose möglich

installation

transformer outside base /// flush-mounting installation possible

Dimmung

phasendimmbar

dimming

phase-cut dimming

Abmessung

Pendel max. 300 cm / Sockel Ø 10 cm / Kopf Ø 6,5 cm

dimension

pendant max. 300 cm / base Ø 10 cm / head Ø 6,5 cm

Lieferung

inkl. Netzteil, Schrauben

delivery

incl. transformer, screws

| | | EUR | +19% |
|----------------|---|--------|---------------|
| A-MPL-P | | 293,28 | 349,00 |
| -KA | Kopf und Sockel in Alu head and base in alu | | |
| -KS | Kopf und Sockel in schwarz head and base in black | +42,02 | +50,00 |
| -PT... | Pendelkabel Textil S = schwarz R = rot W = weiß pendant lead textile S = black R = red W = white | | |
| -PSO | Pendelkabel Textil Sonderfarbe Aufpreis je Pendel (300 cm) pendant lead textile special color additional charge each pendant (300 cm) | +42,02 | +50,00 |

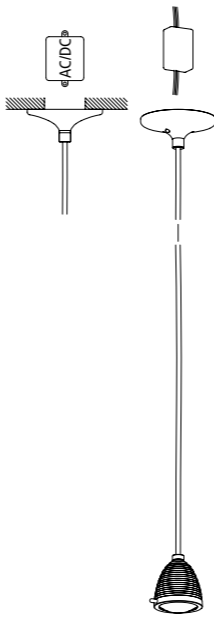



Typ

Pendelleuchte mit Leuchtkopf aus massivem Aluminium /// 50–100° stufenlos einstellbarer Abstrahlwinkel durch Glaslinsenoptik /// flexible Pendelleitung mit farbigem Textilüberzug /// Sockel aus poliertem Beton

Dimmung

wahlweise phasendimmbar / Drehdimmer am Leuchtkopf / DALI

Montage

Netzteil innerhalb Sockel /// Montage über Unterputzdose möglich

Abmessung

Pendel max. 300 cm / Kopf Ø 9 cm / Sockel Ø 15 cm

Lieferung

inkl. Netzteil, Schrauben

type

pendant light with lamp head made of solid aluminium /// glass lens optics with 50–100° infinitely focusable angle beam /// flexible pendant lead with colored textile coating /// base made of polished concrete

dimming

optional phase-cut dimming / rotary dimmer switch / DALI

installation

transformer inside base /// flush-mounting installation possible

dimension

pendant max. 300 cm / head Ø 9 cm / base Ø 15 cm

delivery

incl. transformer, screws



| | | EUR | +19% |
|---------|---|--------|---------|
| Y-BPL-P | phasendimmbar phase-cut dimming | 503,36 | 599,00 |
| Y-BPL-S | Drehdimmer am Leuchtkopf rotary lamp-head dimmer | 503,36 | 599,00 |
| Y-BPL-D | DALI | 503,36 | 599,00 |
| -K... | Kopf in P = poliert SM = schwarz matt SG = schwarz glanz WM = weiß matt WG = weiß glanz head in P = polished SM = black SG = black glossy WM = white WG = white glossy | | |
| -PT... | Pendelkabel Textil S = schwarz R = rot W = weiß pendant lead textile S = black R = red W = white | | |
| -PSO | Pendelkabel Textil Sonderfarbe Aufpreis je Pendel (300 cm) pendant lead textile special color additional charge each pendant (300 cm) | +84,03 | +100,00 |
| -S... | Sockel in Beton G = grau W = weiß base in concrete G = grey W = white | | |



Typ

Pendelleuchte mit Leuchtkopf und Sockel aus massivem Aluminium /// 50–100° stufenlos einstellbarer Abstrahlwinkel durch Glaslinsenoptik /// flexible Pendelleitung mit farbigem Textilüberzug

Dimmung

wahlweise phasendimmbar / Drehdimmer am Leuchtkopf / DALI

Montage

Netzteil außerhalb Sockel /// Montage über Unterputzdose möglich

Abmessung

Pendel max. 300 cm / Kopf Ø 9 cm / Sockel Ø 10 cm

Lieferung

inkl. Netzteil, Schrauben

type

pendant light with lamp head made of solid aluminium /// glass lens optics with 50–100° infinitely focusable angle beam /// flexible pendant lead with colored textile coating

dimming

optional phase-cut dimming / rotary dimmer switch / DALI

installation

transformer outside base /// flush-mounting installation possible

dimension

pendant max. 300 cm / head Ø 9 cm / base Ø 10 cm

delivery

incl. transformer, screws



| | | EUR | +19% |
|---------|---|---------|---------|
| Y-MPL-P | phasendimmbar phase-cut dimming | 503,36 | 599,00 |
| Y-MPL-S | Drehdimmer am Leuchtkopf rotary lamp-head dimmer | 503,36 | 599,00 |
| Y-MPL-D | DALI | 503,36 | 599,00 |
| -K... | Kopf in P = poliert SM = schwarz matt SG = schwarz glanz WM = weiß matt WG = weiß glanz head in P = polished SM = black matt SG = black glossy WM = white matt WG = white glossy | | |
| -PT... | Pendelkabel Textil S = schwarz R = rot W = weiß pendant lead textile S = black R = red W = white | | |
| -PSO | Pendelkabel Textil Sonderfarbe Aufpreis je Pendel (300 cm) pendant lead textile special color additional charge each pendant (300 cm) | +84,03 | +100,00 |
| -SA | Sockel in Alu base in alu | | |
| -SSO | Sockel in Sonderfarbe base in special color | +126,05 | +150,00 |





Z-PDL



Typ

Schienen Flexarmleuchte mit Leuchtkopf aus massivem Aluminium /// 15–75° stufenlos einstellbarer Abstrahlwinkel durch Linsenoptik /// robuste Flexwelle mit gebürsteter Aluminiumoberfläche oder farbigem Textilüberzug /// Lichtschiene aus massivem Eichenholz zur stufenlos verstellbaren Aufnahme von 1–3 Leuchten

Montage

Netzteil innerhalb Schiene

Dimmung

phasendimmbar

Abmessung

PDL1: Länge max. 35 cm / Flexwelle 15 cm / Kopf Ø 3 cm

PDL2: Länge max. 65 cm / Flexwelle 45 cm / Kopf Ø 3 cm

Schiene: L120 x B50 x H40 cm

Lieferung

inkl. Netzteil, Schrauben

type

track flex ceiling light with lamp heads made of solid aluminium /// lens optics with 15–75° infinitely focusable angle beam /// strong flexible shaft in brushed aluminium or colored textile coating /// light track made of massive oak wood for 1–3 infinitely adjustable lights

installation

transformer inside track

dimming

phase-cut dimming

dimension

PDL1: length max. 35 cm / flex 15 cm / head Ø 3 cm

PDL2: length max. 65 cm / flex 45 cm / head Ø 3 cm

track: L120 x W50 x H40 cm

delivery

incl. transformer, screws

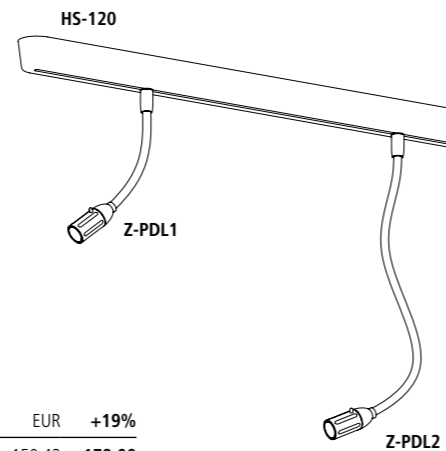

| | | EUR | +19% |
|-----------------|---|---------|---------|
| Z-PDL1 | | 150,42 | 179,00 |
| Z-PDL2 | | 167,23 | 199,00 |
| -KA | Kopf und Sockel in Alu head and base in alu | | |
| -KS | Kopf und Sockel in schwarz head and base in black | +42,02 | +50,00 |
| -FA | Flexwelle mit gebürsteter Aluminiumoberfläche flexible shaft in alu brush-finished | | |
| -FT... | Flexwelle Textil S = schwarz R = rot A = anthrazit W = weiß G = grün U = braun B = blau flexible shaft textile S = black R = red A = anthracite W = white G = green U = brown B = blue | | |
| -FSO | Flexwelle in Sonderfarbe / Welle kürzen / Welle verlängern (auf max. 100 cm), Aufpreis je Welle flexible shaft in special color / to cut short / to extend (max. 100 cm), extra charge each flex | +42,02 | +50,00 |
| HS-120-H | Lichtschiene 120 cm aus massivem Eichenholz, inkl. Netzteil für 1–3 Leuchten light track 120 cm made of massive oak wood, incl. transformer for 1–3 lights | 378,15 | 450,00 |
| HS-120-W | Lichtschiene 120 cm aus massivem Eichenholz weiß lackiert, inkl. Netzteil für 1–3 Leuchten light track 120 cm made of massive oak wood painted white, incl. transformer for 1–3 lights | 420,17 | 500,00 |
| HS-SON | Lichtschiene in Sonderlänge, max. 150 cm, Preis pro Meter, inkl. Netzteil für 1–3 Leuchten light track in special length, max. 150 cm, price per metre, incl. transformer for 1–3 lights | 504,20 | 600,00 |
| HS-SON | Lichtschiene in Sonderfarbe, Aufpreis je Schiene light track in special color, additional charge each track | +126,05 | +150,00 |

Z-3PDL



Typ

Lichtschiene mit 3x PDL Deckenleuchte

Montage

Netzteil innerhalb Schiene

Dimmung

phasendimmbar

Abmessung

PDL1: Länge max. 35 cm / Flexwelle 15 cm / Kopf Ø 3 cm

PDL2: Länge max. 65 cm / Flexwelle 45 cm / Kopf Ø 3 cm

Schiene: L120 x B50 x H40 cm

Lieferung

inkl. Netzteil, Schrauben

type

light track with 3x PDL flex light

installation

transformer inside track

dimming

phase-cut dimming

dimension

PDL1: length max. 35 cm / flex 15 cm / head Ø 3 cm

PDL2: length max. 65 cm / flex 45 cm / head Ø 3 cm

track: L120 x W50 x H40 cm

delivery

incl. transformer, screws

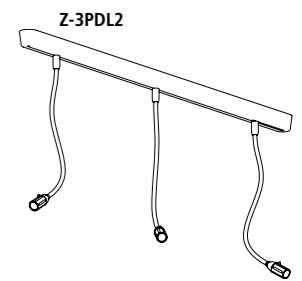
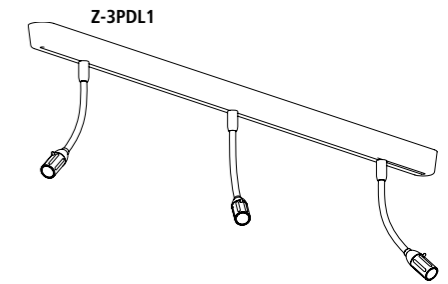

| | | EUR | +19% |
|---------------|---|---------|---------|
| Z-3PDL1 | | 678,99 | 808,00 |
| Z-3PDL2 | | 712,60 | 848,00 |
| -KA | Köpfe und Sockel in Alu heads and bases in alu | | |
| -KS | Köpfe und Sockel in schwarz heads and bases in black | +126,05 | +150,00 |
| -FA | Flexwelle mit gebürsteter Aluminiumoberfläche flexible shaft in alu brush-finished | | |
| -FT... | Flexwelle Textil S = schwarz R = rot A = anthrazit W = weiß G = grün U = braun B = blau flexible shaft textile S = black R = red A = anthracite W = white G = green U = brown B = blue | | |
| -FSO | Flexwelle in Sonderfarbe / Welle kürzen / Welle verlängern (auf max. 100 cm), Aufpreis je Welle flexible shaft in special color / to cut short / to extend (max. 100 cm), extra charge each flex | +42,02 | +50,00 |
| -H | Lichtschiene 120 cm aus massivem Eichenholz, für 1–3 Leuchten light track 120 cm made of massive oak wood, for 1–3 lights | | |
| -W | Lichtschiene 120 cm aus massivem Eichenholz weiß lackiert, für 1–3 Leuchten light track 120 cm made of massive oak wood painted white, for 1–3 lights | +42,02 | +50,00 |

A-PDL



Typ

Schienen-Flexarmleuchte mit Leuchtkopf aus massivem Aluminium /// 25–100° stufenlos einstellbarer Abstrahlwinkel durch Glaslinsenoptik /// robuste Flexwelle mit gebürsteter Aluminiumoberfläche oder farbigem Textilüberzug /// Lichtschiene aus massivem Eichenholz zur stufenlos verstellbaren Aufnahme von 1–3 Leuchten

Montage

Netzteil innerhalb Schiene

Dimmung

phasendimmbar

Abmessung

PDL1: Länge max. 35 cm / Flexwelle 15 cm / Kopf Ø 6,5 cm
PDL2: Länge max. 65 cm / Flexwelle 45 cm / Kopf Ø 6,5 cm
Schiene: L120 x B50 x H40 cm

Lieferung

inkl. Netzteil, Schrauben

type

track flex ceiling light with lamp head made of solid aluminium /// glass lens optics with 25–100° infinitely focusable angle beam /// strong flexible shaft in brushed aluminium or colored textile coating /// light track in massive oak wood for 1–3 infinitely adjustable lights

installation

transformer inside track

dimming

phase-cut dimming

dimension

PDL1: length max. 35 cm / flex 15 cm / head Ø 6,5 cm
PDL2: length max. 65 cm / flex 45 cm / head Ø 6,5 cm
track: L120 x W50 x H40 cm

delivery

incl. transformer, screws

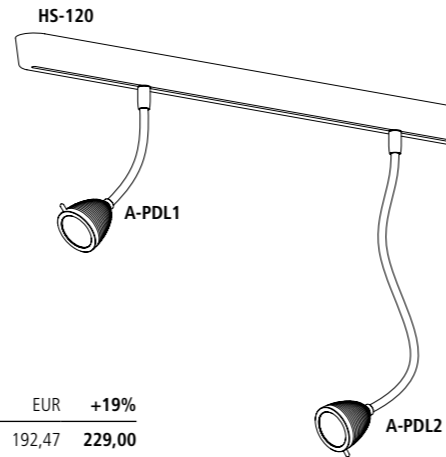

| | | EUR | +19% |
|-----------------|---|---------|---------|
| A-PDL1 | | 192,47 | 229,00 |
| A-PDL2 | | 209,24 | 249,00 |
| -KA | Kopf und Sockel in Alu head and base in alu | | |
| -KS | Kopf und Sockel in schwarz head and base in black | +42,02 | +50,00 |
| -FA | Flexwelle mit gebürsteter Aluminiumoberfläche flexible shaft in alu brush-finished | | |
| -FT... | Flexwelle Textil S = schwarz R = rot A = anthrazit W = weiß G = grün U = braun B = blau flexible shaft textile S = black R = red A = anthracite W = white G = green U = brown B = blue | | |
| -FSO | Flexwelle in Sonderfarbe / Welle kürzen / Welle verlängern (auf max. 100 cm), Aufpreis je Welle flexible shaft in special color / to cut short / to extend (max. 100 cm), extra charge each flex | +42,02 | +50,00 |
| HS-120-H | Lichtschiene 120 cm aus massivem Eichenholz, inkl. Netzteil für 1–3 Leuchten light track 120 cm in massive oak wood, incl. transformer for 1–3 lights | 378,15 | 450,00 |
| HS-120-W | Lichtschiene 120 cm aus massivem Eichenholz weiß lackiert, inkl. Netzteil für 1–3 Leuchten light track 120 cm in massive oak wood painted white, incl. transformer for 1–3 lights | 420,17 | 500,00 |
| HS-SON | Lichtschiene in Sonderlänge, max. 150 cm, Preis pro Meter, inkl. Netzteil für 1–3 Leuchten light track in special length, max. 150 cm, price per metre, incl. transformer for 1–3 lights | 504,20 | 600,00 |
| HS-SON | Lichtschiene in Sonderfarbe, Aufpreis je Schiene light track in special color, additional charge each track | +126,05 | +150,00 |

A-2PDL



Typ

Lichtschiene mit 2x PDL Deckenleuchte

Montage

Netzteil innerhalb Schiene

Dimmung

phasendimmbar

Abmessung

PDL1: Länge max. 35 cm / Flexwelle 15 cm / Kopf Ø 6,5 cm
PDL2: Länge max. 65 cm / Flexwelle 45 cm / Kopf Ø 6,5 cm
Schiene: L120 x B50 x H40 cm

Lieferung

inkl. Netzteil, Schrauben

type

light track with 2x PDL flex ceiling light

installation

transformer inside track

dimming

phase-cut dimming

dimension

PDL1: length max. 35 cm / flex 15 cm / head Ø 6,5 cm
PDL2: length max. 65 cm / flex 45 cm / head Ø 6,5 cm
track: L120 x W50 x H40 cm

delivery

incl. transformer, screws

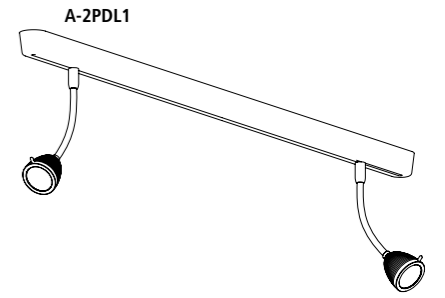

| | | EUR | +19% |
|---------------|---|--------|---------|
| A-2PDL1 | | 763,02 | 908,00 |
| A-2PDL2 | | 796,64 | 948,00 |
| -KA | Köpfe und Sockel in Alu heads and bases in alu | | |
| -KS | Köpfe und Sockel in schwarz heads and bases in black | +84,03 | +100,00 |
| -FA | Flexwelle mit gebürsteter Aluminiumoberfläche flexible shaft in alu brush-finished | | |
| -FT... | Flexwelle Textil S = schwarz R = rot A = anthrazit W = weiß G = grün U = braun B = blau flexible shaft textile S = black R = red A = anthracite W = white G = green U = brown B = blue | | |
| -FSO | Flexwelle in Sonderfarbe / Welle kürzen / Welle verlängern (auf max. 100 cm), Aufpreis je Welle flexible shaft in special color / to cut short / to extend (max. 100 cm), extra charge each flex | +42,02 | +50,00 |
| -H | Lichtschiene 120 cm aus massivem Eichenholz, für 1–3 Leuchten light track 120 cm in massive oak wood, for 1–3 lights | | |
| -W | Lichtschiene 120 cm aus massivem Eichenholz weiß lackiert, für 1–3 Leuchten light track 120 cm in massive oak wood painted white, for 1–3 lights | +42,02 | +50,00 |

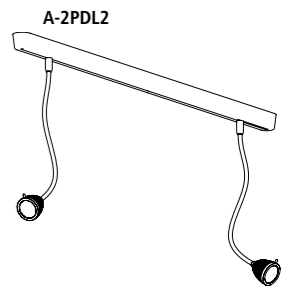

A-3PDL



Typ

Lichtschiene mit 3x PDL Deckenleuchte

Montage

Netzteil innerhalb Schiene

Dimmung

phasendimmbar

Abmessung

PDL1: Länge max. 35 cm / Flexwelle 15 cm / Kopf Ø 6,5 cm
PDL2: Länge max. 65 cm / Flexwelle 45 cm / Kopf Ø 6,5 cm
Schiene: L120 x B50 x H40 cm

Lieferung

inkl. Netzteil, Schrauben

type

light track with 3x PDL flex ceiling light

installation

transformer inside track

dimming

phase-cut dimming

dimension

PDL1: length max. 35 cm / flex 15 cm / head Ø 6,5 cm
PDL2: length max. 65 cm / flex 45 cm / head Ø 6,5 cm
track: L120 x W50 x H40 cm

delivery

incl. transformer, screws

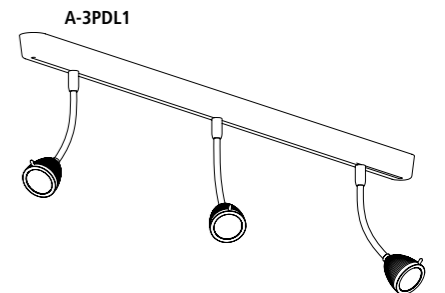

| | | EUR | +19% |
|---------------|---|----------|----------|
| A-3PDL1 | | 955,46 | 1.137,00 |
| A-3PDL2 | | 1.005,88 | 1.197,00 |
| -KA | Köpfe und Sockel in Alu heads and bases in alu | | |
| -KS | Köpfe und Sockel in schwarz heads and bases in black | +126,05 | +150,00 |
| -FA | Flexwelle mit gebürsteter Aluminiumoberfläche flexible shaft in alu brush-finished | | |
| -FT... | Flexwelle Textil S = schwarz R = rot A = anthrazit W = weiß G = grün U = braun B = blau flexible shaft textile S = black R = red A = anthracite W = white G = green U = brown B = blue | | |
| -FSO | Flexwelle in Sonderfarbe / Welle kürzen / Welle verlängern (auf max. 100 cm), Aufpreis je Welle flexible shaft in special color / to cut short / to extend (max. 100 cm), extra charge each flex | +42,02 | +50,00 |
| -H | Lichtschiene 120 cm aus massivem Eichenholz, für 1–3 Leuchten light track 120 cm in massive oak wood, for 1–3 lights | | |
| -W | Lichtschiene 120 cm aus massivem Eichenholz weiß lackiert, für 1–3 Leuchten light track 120 cm in massive oak wood painted white, for 1–3 lights | +42,02 | +50,00 |

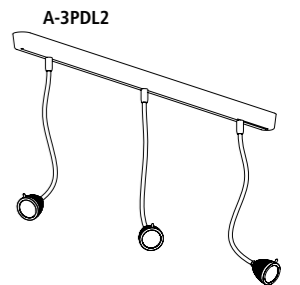

Y-PDS



Typ

Schienen Deckenstrahler mit Leuchtkopf aus massivem Aluminium /// 50–100° stufenlos einstellbarer Abstrahlwinkel durch Glaslinsenoptik /// Lichtschiene aus massivem Eichenholz zur stufenlos verstellbaren Aufnahme von 1–3 Leuchten

Montage

Netzteil innerhalb Schiene

Dimmung

wahlweise phasendimmbar oder Drehdimmer am Leuchtkopf

Abmessung

PDS: Höhe 15 cm / Kopf Ø 9 cm
Schiene: L120 x B50 x H40 cm

Lieferung

inkl. Netzteil, Schrauben

type

track ceiling spotlight with lamp head made of solid aluminium /// glass lens optics with 50–100° infinitely focusable angle beam /// light track made of massive oak wood for 1–3 infinitely adjustable lights

installation

transformer inside track

dimming

optional phase-cut dimming / rotary dimmer switch

dimension

PDS: height 15 cm / head Ø 9 cm
track: L120 x W50 x H40 cm

delivery

incl. transformer, screws

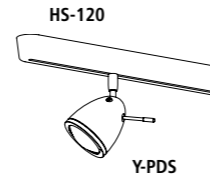

| | | EUR | +19% |
|-----------------|---|---------|----------------|
| Y-PDS-P | phasendimmbar phase-cut dimming | 335,29 | 399,00 |
| Y-PDS-S | Drehdimmer am Leuchtkopf rotary lamp-head dimmer | 335,29 | 399,00 |
| -K... | Kopf in P = poliert SM = schwarz matt SG = schwarz glanz WM = weiß matt WG = weiß glanz head in P = polished SM = black matt SG = black glossy WM = white matt WG = white glossy | | |
| HS-120-H | Lichtschiene 120 cm aus massivem Eichenholz, inkl. Netzteil für 1–3 Leuchten light track 120 cm made of massive oak wood, incl. transformer for 1–3 lights | 378,15 | 450,00 |
| HS-120-W | Lichtschiene 120 cm aus massivem Eichenholz weiß lackiert, inkl. Netzteil für 1–3 Leuchten light track 120 cm made of massive oak wood painted white, incl. transformer for 1–3 lights | 420,17 | 500,00 |
| HS-SON | Lichtschiene in Sonderlänge, max. 150 cm, Preis pro Meter, inkl. Netzteil für 1–3 Leuchten light track in special length, max. 150 cm, price per metre, incl. transformer for 1–3 lights | 504,20 | 600,00 |
| HS-SON | Lichtschiene in Sonderfarbe, Aufpreis je Schiene light track in special color, additional charge each track | +126,05 | +150,00 |

Y-2PDS



Typ

Lichtschiene mit 2x PDS Deckenleuchte

Montage

Netzteil innerhalb Schiene

Dimmung

wahlweise phasendimmbar oder Drehdimmer am Leuchtkopf

Abmessung

PDS: Höhe 15 cm / Kopf Ø 9 cm
Schiene: L120 x B50 x H40 cm

Lieferung

inkl. Netzteil, Schrauben

type

light track with 2x PDS ceiling light

installation

transformer inside track

dimming

optional phase-cut dimming / rotary dimmer switch

dimension

PDS: height 15 cm / head Ø 9 cm
track: L120 x W50 x H40 cm

delivery

incl. transformer, screws

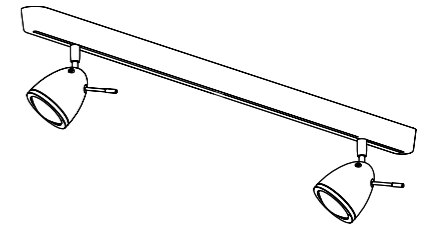

| | | EUR | +19% |
|-----------------|---|----------|-----------------|
| Y-2PDS-P | phasendimmbar phase-cut dimming | 1.048,74 | 1.248,00 |
| Y-2PDS-S | Drehdimmer am Leuchtkopf rotary lamp-head dimmer | 1.048,74 | 1.248,00 |
| -K... | Kopf in P = poliert SM = schwarz matt SG = schwarz glanz WM = weiß matt WG = weiß glanz head in P = polished SM = black matt SG = black glossy WM = white matt WG = white glossy | | |
| -H | Lichtschiene 120 cm aus massivem Eichenholz, für 1–3 Leuchten light track 120 cm made of massive oak wood, for 1–3 lights | | |
| -W | Lichtschiene 120 cm aus massivem Eichenholz weiß lackiert, für 1–3 Leuchten light track 120 cm made of massive oak wood painted white, for 1–3 lights | +42,02 | +50,00 |

Y-3PDS



Typ

Lichtschiene mit 3x PDS Deckenleuchte

Montage

Netzteil innerhalb Schiene

Dimmung

wahlweise phasendimmbar oder Drehdimmer am Leuchtkopf

Abmessung

PDS: Höhe 15 cm / Kopf Ø 9 cm
Schiene: L120 x B50 x H40 cm

Lieferung

inkl. Netzteil, Schrauben

type

light track with 3x PDS ceiling light

installation

transformer inside track

dimming

optional phase-cut dimming / rotary dimmer switch

dimension

PDS: height 15 cm / head Ø 9 cm
track: L120 x W50 x H40 cm

delivery

incl. transformer, screws

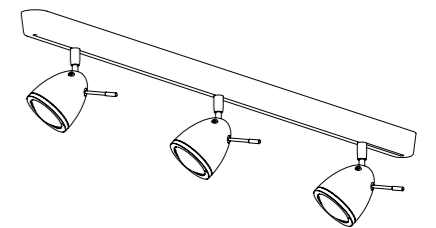

| | | EUR | +19% |
|-----------------|---|----------|-----------------|
| Y-3PDS-P | phasendimmbar phase-cut dimming | 1.384,03 | 1.647,00 |
| Y-3PDS-S | Drehdimmer am Leuchtkopf rotary lamp-head dimmer | 1.384,03 | 1.647,00 |
| -K... | Kopf in P = poliert SM = schwarz matt SG = schwarz glanz WM = weiß matt WG = weiß glanz head in P = polished SM = black matt SG = black glossy WM = white matt WG = white glossy | | |
| -H | Lichtschiene 120 cm aus massivem Eichenholz, für 1–3 Leuchten light track 120 cm made of massive oak wood, for 1–3 lights | | |
| -W | Lichtschiene 120 cm aus massivem Eichenholz weiß lackiert, für 1–3 Leuchten light track 120 cm made of massive oak wood painted white, for 1–3 lights | +42,02 | +50,00 |

A-PPL



Typ

Schienen Pendelleuchte mit Leuchtkopf aus massivem Aluminium /// 25–100° stufenlos einstellbarer Abstrahlwinkel durch Glaslinsoptik /// flexible Pendelleitung mit farbigem Textilüberzug /// Lichtschiene aus massivem Eichenholz zur stufenlos verstellbaren Aufnahme von 1–3 Leuchten

Montage

Netzteil innerhalb Schiene

Dimmung

phasendimmbar

Abmessung

Pendel max. 300 cm / Kopf Ø 6,5 cm
Schiene: L120 x B50 x H40 cm

Lieferung

inkl. Netzteil, Schrauben

type

track pendant light with lamp head made of solid aluminium /// glass lens optics with 25–100° infinitely focusable angle beam /// flexible pendant lead with colored textile coating /// light track in massive oak wood for 1–3 infinitely adjustable lights

installation

transformer inside track

dimming

phase-cut dimming

dimension

pendant max. 300 cm / head Ø 6,5 cm
track: L120 x W50 x H40 cm

delivery

incl. transformer, screws

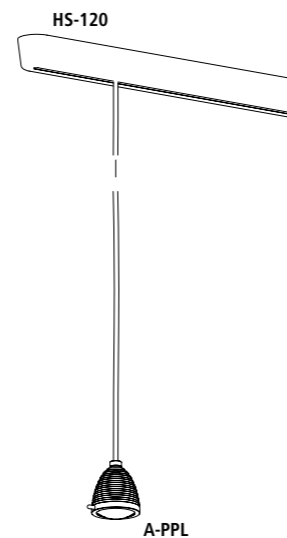

A-PPL

| | | EUR | +19% |
|-----------------|---|---------|----------------|
| A-PPL | | 209,24 | 249,00 |
| -KA | Kopf in Alu head in alu | | |
| -KS | Kopf in schwarz head in black | +21,01 | +25,00 |
| -PT... | Pendelkabel Textil S = schwarz R = rot W = weiß pendant lead textile S = black R = red W = white | | |
| -PSO | Pendelkabel Textil Sonderfarbe Aufpreis je Pendel (300 cm) pendant lead textile special color additional charge each pendant (300 cm) | +42,02 | +50,00 |
| HS-120-H | Lichtschiene 120 cm aus massivem Eichenholz, inkl. Netzteil für 1–3 Leuchten light track 120 cm in massive oak wood, incl. transformer for 1–3 lights | 378,15 | 450,00 |
| HS-120-W | Lichtschiene 120 cm aus massivem Eichenholz weiß lackiert, inkl. Netzteil für 1–3 Leuchten light track 120 cm in massive oak wood painted white, incl. transformer for 1–3 lights | 420,17 | 500,00 |
| HS-SON | Lichtschiene in Sonderlänge, max. 150 cm, Preis pro Meter, inkl. Netzteil für 1–3 Leuchten light track in special length, max. 150 cm, price per metre, incl. transformer for 1–3 lights | 504,20 | 600,00 |
| HS-SON | Lichtschiene in Sonderfarbe, Aufpreis je Schiene light track in special color, additional charge each track | +126,05 | +150,00 |

A-2PPL



Typ

Lichtschiene mit 2x PPL Pendelleuchte

Montage

Netzteil innerhalb Sockel

Dimmung

phasendimmbar

Abmessung

Pendel max. 300 cm / Kopf Ø 6,5 cm
Schiene: L120 x B50 x H40 cm

Lieferung

inkl. Netzteil, Schrauben

type

light track with 2x PPL pendant light

installation

transformer inside track

dimming

phase-cut dimming

dimension

pendant max. 300 cm / head Ø 6,5 cm
track: L120 x W50 x H40 cm

delivery

incl. transformer, screws

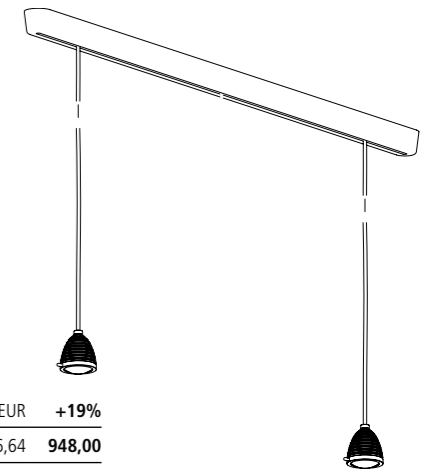

| | | EUR | +19% |
|---------------|---|--------|---------------|
| A-2PPL | | 796,64 | 948,00 |
| -KA | Köpfe in Alu heads and bases in alu | | |
| -KS | Köpfe in schwarz heads in black | +42,02 | +50,00 |
| -PT... | Pendelkabel Textil S = schwarz R = rot W = weiß pendant lead textile S = black R = red W = white | | |
| -PSO | Pendelkabel Textil Sonderfarbe Aufpreis je Pendel (300 cm) pendant lead textile special color additional charge each pendant (300 cm) | +42,02 | +50,00 |
| -H | Lichtschiene 120 cm aus massivem Eichenholz, für 1–3 Leuchten light track 120 cm in massive oak wood, for 1–3 lights | | |
| -W | Lichtschiene 120 cm aus massivem Eichenholz weiß lackiert, für 1–3 Leuchten light track 120 cm in massive oak wood painted white, for 1–3 lights | +42,02 | +50,00 |

A-3PPL



Typ

Lichtschiene mit 3x PPL Pendelleuchte

Montage

Netzteil innerhalb Sockel

Dimmung

phasendimmbar

Abmessung

Pendel max. 300 cm / Kopf Ø 6,5 cm
Schiene: L120 x B50 x H40 cm

Lieferung

inkl. Netzteil, Schrauben

type

light track with 3x PPL pendant light

installation

transformer inside track

dimming

phase-cut dimming

dimension

pendant max. 300 cm / head Ø 6,5 cm
track: L120 x W50 x H40 cm

delivery

incl. transformer, screws

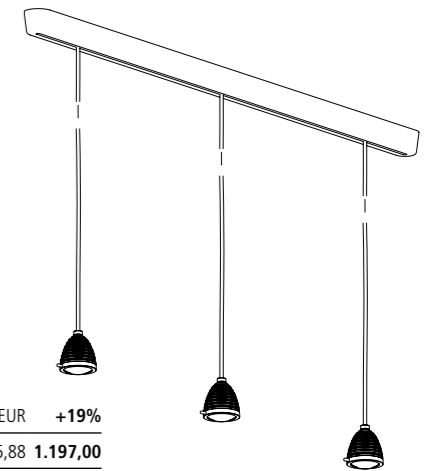

| | | EUR | +19% |
|---------------|---|----------|-----------------|
| A-3PPL | | 1.005,88 | 1.197,00 |
| -KA | Köpfe in Alu heads and bases in alu | | |
| -KS | Köpfe in schwarz heads in black | +63,02 | +75,00 |
| -PT... | Pendelkabel Textil S = schwarz R = rot W = weiß pendant lead textile S = black R = red W = white | | |
| -PSO | Pendelkabel Textil Sonderfarbe Aufpreis je Pendel (300 cm) pendant lead textile special color additional charge each pendant (300 cm) | +42,02 | +50,00 |
| -H | Lichtschiene 120 cm aus massivem Eichenholz, für 1–3 Leuchten light track 120 cm in massive oak wood, for 1–3 lights | | |
| -W | Lichtschiene 120 cm aus massivem Eichenholz weiß lackiert, für 1–3 Leuchten light track 120 cm in massive oak wood painted white, for 1–3 lights | +42,02 | +50,00 |

Y-PPL



Typ

Schienen Pendelleuchte mit Leuchtkopf aus massivem Aluminium /// 50–100° stufenlos einstellbarer Abstrahlwinkel durch Glaslinsenoptik /// flexible Pendelleitung mit farbigem Textilüberzug /// Lichtschiene aus massivem Eichenholz zur stufenlos verstellbaren Aufnahme von 1–3 Leuchten

Montage

Netzteil innerhalb Schiene

Dimmung

wahlweise phasendimmbar oder Drehdimmer am Leuchtkopf

Abmessung

PPL: Pendel max. 300 cm / Kopf Ø 9 cm

Schiene: L120 x B5 x H4 cm

Lieferung

inkl. Netzteil, Schrauben

type

track pendant light with lamp head made of solid aluminium /// glass lens optics with 50–100° infinitely focusable angle beam /// flexible pendant lead with colored textile coating /// light track made of massive oak wood for 1–3 infinitely adjustable lights

installation

transformer inside track

dimming

optional phase-cut dimming / rotary dimmer switch

dimension

PPL: pendant max. 300 cm / head Ø 9 cm

track: L120 x W5 x H4 cm

delivery

incl. transformer, screws

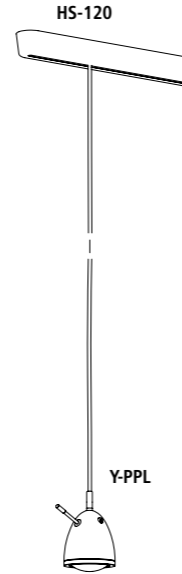

| | | EUR | +19% |
|-----------------|---|---------|----------------|
| Y-PPL-P | phasendimmbar phase-cut dimming | 419,33 | 499,00 |
| Y-PPL-S | Drehdimmer am Leuchtkopf rotary lamp-head dimmer | 419,33 | 499,00 |
| -K... | Kopf in P = poliert SM = schwarz matt SG = schwarz glanz WM = weiß matt WG = weiß glanz head in P = polished SM = black SG = black glossy WM = white WG = white glossy | | |
| -PT... | Pendelkabel Textil S = schwarz R = rot W = weiß pendant lead textile S = black R = red W = white | | |
| -PSO | Pendelkabel Textil Sonderfarbe Aufpreis je Pendel pendant lead textile special color additional charge each pendant | +84,03 | +100,00 |
| HS-120-H | Lichtschiene 120 cm aus massivem Eichenholz, inkl. Netzteil für 1–3 Leuchten light track 120 cm made of massive oak wood, incl. transformer for 1–3 lights | 378,15 | 450,00 |
| HS-120-W | Lichtschiene 120 cm aus massivem Eichenholz weiß lackiert, inkl. Netzteil für 1–3 Leuchten light track 120 cm made of massive oak wood painted white, incl. transformer for 1–3 lights | 420,17 | 500,00 |
| HS-SON | Lichtschiene in Sonderlänge, max. 150 cm, Preis pro Meter, inkl. Netzteil für 1–3 Leuchten light track in special length, max. 150 cm, price per metre, incl. transformer for 1–3 lights | 504,20 | 600,00 |
| HS-SON | Lichtschiene in Sonderfarbe, Aufpreis je Schiene light track in special color, additional charge each track | +126,05 | +150,00 |

Y-2PPL



Typ

Lichtschiene mit 2x PPL Pendelleuchte

Montage

Netzteil innerhalb Schiene

Dimmung

wahlweise phasendimmbar oder Drehdimmer am Leuchtkopf

Abmessung

PPL: Pendel max. 300 cm / Kopf Ø 9 cm

Schiene: L120 x B5 x H4 cm

Lieferung

inkl. Netzteil, Schrauben

type

light track with 2x PPL pendant light

installation

transformer inside track

dimming

optional phase-cut dimming / rotary dimmer switch

dimension

PPL: pendant max. 300 cm / head Ø 9 cm

track: L120 x W5 x H4 cm

delivery

incl. transformer, screws

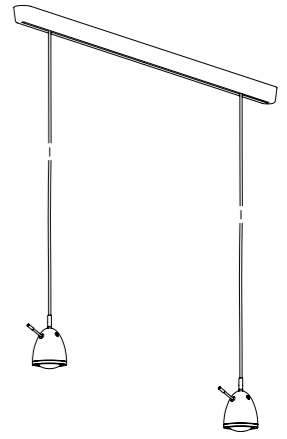

| | | EUR | +19% |
|-----------------|---|----------|-----------------|
| Y-2PPL-P | phasendimmbar phase-cut dimming | 1.216,81 | 1.448,00 |
| Y-2PPL-S | Drehdimmer am Leuchtkopf rotary lamp-head dimmer | 1.216,81 | 1.448,00 |
| -K... | Kopf in P = poliert SM = schwarz matt SG = schwarz glanz WM = weiß matt WG = weiß glanz head in P = polished SM = black SG = black glossy WM = white WG = white glossy | | |
| -PT... | Pendelkabel Textil S = schwarz R = rot W = weiß pendant lead textile S = black R = red W = white | | |
| -PSO | Pendelkabel Textil Sonderfarbe Aufpreis je Pendel pendant lead textile special color additional charge each pendant | +84,03 | +100,00 |
| -H | Lichtschiene 120 cm aus massivem Eichenholz, für 1–3 Leuchten light track 120 cm made of massive oak wood, for 1–3 lights | | |
| -W | Lichtschiene 120 cm aus massivem Eichenholz weiß lackiert, für 1–3 Leuchten light track 120 cm made of massive oak wood painted white, for 1–3 lights | +42,02 | +50,00 |

Y-3PPL



Typ

Lichtschiene mit 3x PPL Pendelleuchte

Montage

Netzteil innerhalb Schiene

Dimmung

wahlweise phasendimmbar oder Drehdimmer am Leuchtkopf

Abmessung

PPL: Pendel max. 300 cm / Kopf Ø 9 cm

Schiene: L120 x B5 x H4 cm

Lieferung

inkl. Netzteil, Schrauben

type

light track with 3x PPL pendant light

installation

transformer inside track

dimming

optional phase-cut dimming / rotary dimmer switch

dimension

PPL: pendant max. 300 cm / head Ø 9 cm

track: L120 x W5 x H4 cm

delivery

incl. transformer, screws

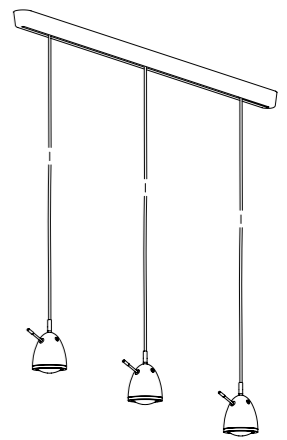

| | | EUR | +19% |
|-----------------|---|----------|-----------------|
| Y-3PPL-P | phasendimmbar phase-cut dimming | 1.636,13 | 1.947,00 |
| Y-3PPL-S | Drehdimmer am Leuchtkopf rotary lamp-head dimmer | 1.636,13 | 1.947,00 |
| -K... | Kopf in P = poliert SM = schwarz matt SG = schwarz glanz WM = weiß matt WG = weiß glanz head in P = polished SM = black SG = black glossy WM = white WG = white glossy | | |
| -PT... | Pendelkabel Textil S = schwarz R = rot W = weiß pendant lead textile S = black R = red W = white | | |
| -PSO | Pendelkabel Textil Sonderfarbe Aufpreis je Pendel pendant lead textile special color additional charge each pendant | +84,03 | +100,00 |
| -H | Lichtschiene 120 cm aus massivem Eichenholz, für 1–3 Leuchten light track 120 cm made of massive oak wood, for 1–3 lights | | |
| -W | Lichtschiene 120 cm aus massivem Eichenholz weiß lackiert, für 1–3 Leuchten light track 120 cm made of massive oak wood painted white, for 1–3 lights | +42,02 | +50,00 |

A-SDL



Typ

3-Phasen Flexarmleuchte mit Leuchtkopf aus massivem Aluminium /// 25–100° stufenlos einstellbarer Abstrahlwinkel durch Glaslinsenoptik /// robuste Flexwelle mit gebürsteter Aluminiumoberfläche oder farbigem Textilüberzug

Dimmung

phasendimmbar

Abmessung

SDL1: Länge bis 35 cm / Flexwelle 15 cm / Sockel Ø 6,5 cm / Kopf Ø 6,5 cm
SDL2: Länge bis 65 cm / Flexwelle 45 cm / Sockel Ø 6,5 cm / Kopf Ø 6,5 cm

Lieferung

inkl. Netzteil, 3-Phasenadapter

type

power rail ceiling flex light with lamp head and base made of solid aluminium /// glass lens optics with 25–100° infinitely focusable angle beam /// strong flexible shaft in brushed aluminium or colored textile coating

dimming

phase-cut dimming

dimension

SDL1: length up to 35 cm / flex 15 cm / base Ø 6,5 cm / head Ø 6,5 cm
SDL2: length up to 65 cm / flex 45 cm / base Ø 6,5 cm / head Ø 6,5 cm

delivery

incl. transformer, power rail adapter

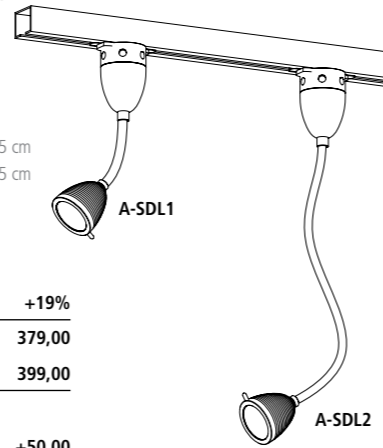

| | | EUR | +19% |
|--------|---|--------|--------|
| A-SDL1 | | 318,49 | 379,00 |
| A-SDL2 | | 335,29 | 399,00 |
| -KA | Kopf und Sockel in Alu head and base in alu | | |
| -KS | Kopf und Sockel in schwarz head and base in black | +42,02 | +50,00 |
| -FA | Flexwelle mit gebürsteter Aluminiumoberfläche flexible shaft in alu brush-finished | | |
| -FT... | Flexwelle Textil S = schwarz R = rot A = anthrazit W = weiß G = grün U = braun B = blau flexible shaft textile S = black R = red A = anthracite W = white G = green U = brown B = blue | | |
| -FSO | Flexwelle in Sonderfarbe / Welle kürzen / Welle verlängern (auf max. 100 cm), Aufpreis je Welle flexible shaft in special color / to cut short / to extend (max. 100 cm), extra charge each flex | +42,02 | +50,00 |

A-SPL



Typ

3-Phasen Pendelleuchte mit Leuchtkopf aus massivem Aluminium /// 25–100° stufenlos einstellbarer Abstrahlwinkel durch Glaslinsenoptik /// flexible Pendelleitung mit farbigem Textilüberzug

Dimmung

phasendimmbar

Abmessung

Pendel max. 300 cm / Sockel Ø 6,5 cm / Kopf Ø 6,5 cm

Lieferung

inkl. Netzteil, 3-Phasenadapter

type

power rail pendant light with lamp head and base made of solid aluminium /// glass lens optics with 25–100° infinitely focusable angle beam /// flexible pendant lead with colored textile coating

dimming

phase-cut dimming

dimension

pendant max. 300 cm / base Ø 6,5 cm / head Ø 6,5 cm

delivery

incl. transformer, power rail adapter

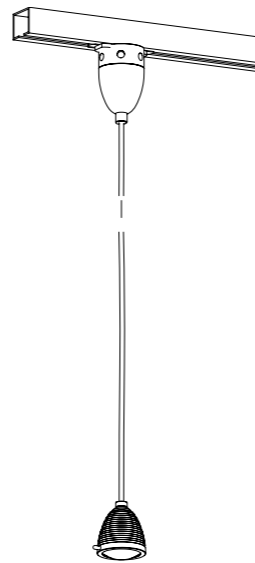

| | | EUR | +19% |
|--------|--|--------|--------|
| A-SPL | | 310,08 | 369,00 |
| -KA | Kopf und Sockel in Alu head and base in alu | | |
| -KS | Kopf und Sockel in schwarz head and base in black | +42,02 | +50,00 |
| -PT... | Pendelkabel Textil S = schwarz R = rot W = weiß pendant lead textile S = black R = red W = white | | |
| -PSO | Pendelkabel Textil Sonderfarbe Aufpreis je Pendel pendant lead textile special color additional charge each pendant | +42,02 | +50,00 |

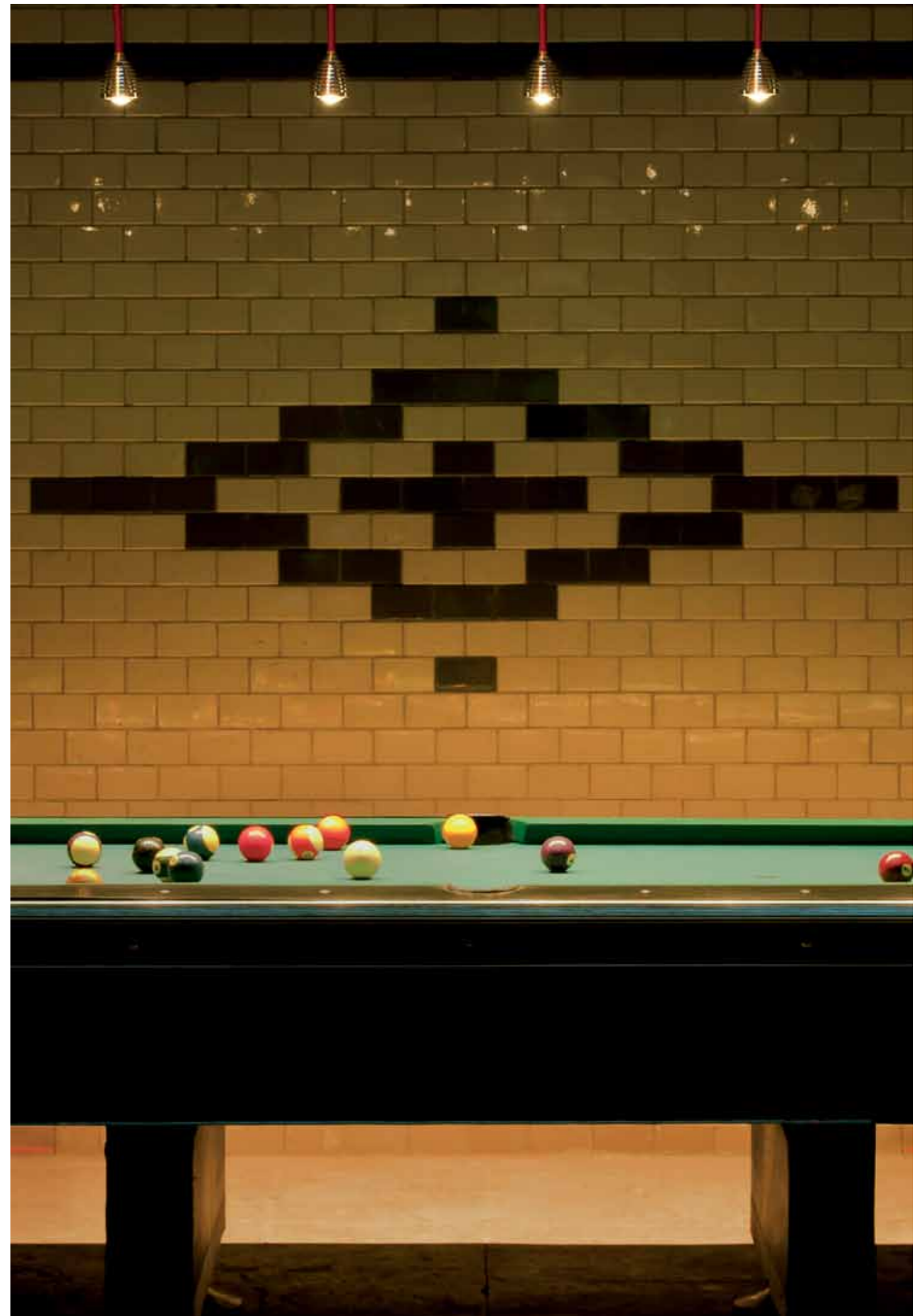

Y-SDS



Typ

Deckenstrahler für 3-Phasenschiene mit Leuchtkopf und Sockel aus massivem Aluminium /// 50–100° stufenlos einstellbarer Abstrahlwinkel durch Glaslinsenoptik

type

ceiling spotlight for power track with lamp head made of solid aluminium /// glass lens optics with 50–100° infinitely focusable angle beam

Dimmung

wahlweise phasendimmbar / Drehdimmer am Leuchtkopf / DALI

dimming

optional phase-cut dimming / rotary dimmer switch / DALI

Abmessung

Höhe 20 cm / Sockel Ø 6 x 15 cm / Kopf Ø 9 cm

dimension

height 20 cm / base Ø 6 x 15 cm / head Ø 9 cm

Lieferung

inkl. Netzteil, 3-Phasenadapter

delivery

incl. transformer, power rail adapter

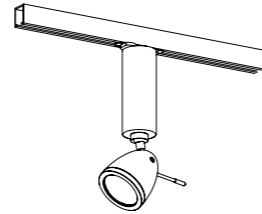

| | | EUR | +19% |
|---------|---|--------|--------|
| Y-SDS-P | phasendimmbar phase-cut dimming | 503,36 | 599,00 |
| Y-SDS-S | Drehdimmer am Leuchtkopf rotary lamp-head dimmer | 503,36 | 599,00 |
| Y-SDS-D | DALI | 503,36 | 599,00 |
| -K... | Kopf in P = poliert SM = schwarz matt SG = schwarz glanz WM = weiß matt WG = weiß glanz head in P = polished SM = black SG = black glossy WM = white WG = white glossy | | |

Y-SDL



Typ

Deckenleuchte für 3-Phasenschiene mit Leuchtkopf und Sockel aus massivem Aluminium /// 50–100° stufenlos einstellbarer Abstrahlwinkel durch Glaslinsenoptik /// höhenverstellbares Teleskoprohr mit Lederschlaufe

type

ceiling light for power track with lamp head and telescope tube made of solid aluminium /// glass lens optics with 50–100° infinitely focusable angle beam /// height adjustable telescope tube with leather loop

Dimmung

wahlweise phasendimmbar / Drehdimmer am Leuchtkopf / DALI

dimming

optional phase-cut dimming / rotary dimmer switch / DALI

Abmessung

Höhe bis 140 cm / Teleskop 75–140 cm / Kopf Ø 9 cm / Sockel Ø 6 x 15 cm

dimension

height up 140 cm / telescope 70–140 cm / head Ø 9 cm / base Ø 6 x 15 cm

Lieferung

inkl. Netzteil, 3-Phasenadapter

delivery

incl. transformer, power rail adapter

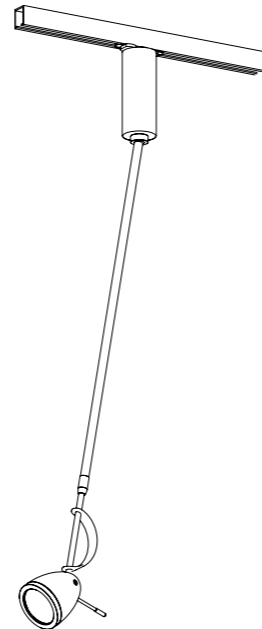

| | | EUR | +19% |
|---------|---|--------|--------|
| Y-SDL-P | phasendimmbar phase-cut dimming | 671,43 | 799,00 |
| Y-SDL-S | Drehdimmer am Leuchtkopf rotary lamp-head dimmer | 671,43 | 799,00 |
| Y-SDL-D | DALI | 671,43 | 799,00 |
| -K... | Kopf in P = poliert SM = schwarz matt SG = schwarz glanz WM = weiß matt WG = weiß glanz head in P = polished SM = black SG = black glossy WM = white WG = white glossy | | |

Y-SPL



Typ

Pendelleuchte für 3-Phasenschiene mit Leuchtkopf und Sockel aus massivem Aluminium /// 50–100° stufenlos einstellbarer Abstrahlwinkel durch Glaslinsenoptik /// flexible Pendelleitung mit farbigem Textilüberzug

type

pendant light for power track with lamp head made of solid aluminium /// glass lens optics with 50–100° infinitely focusable angle beam /// flexible pendant lead with colored textile coating

Dimmung

wahlweise phasendimmbar / Drehdimmer am Leuchtkopf / DALI

dimming

optional phase-cut dimming / rotary dimmer switch / DALI

Abmessung

Pendel max. 300 cm / Sockel Ø 6 x 15 cm / Kopf Ø 9 cm

dimension

pendant max. 300 cm / base Ø 6 x 15 cm / head Ø 9 cm

Lieferung

inkl. Netzteil, 3-Phasenadapter

delivery

incl. transformer, power rail adapter

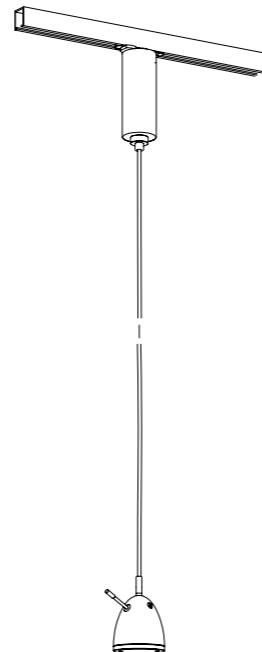

| | | EUR | +19% |
|---------|---|--------|---------|
| Y-SPL-P | phasendimmbar phase-cut dimming | 587,39 | 699,00 |
| Y-SPL-S | Drehdimmer am Leuchtkopf rotary lamp-head dimmer | 587,39 | 699,00 |
| Y-SPL-D | DALI | 587,39 | 699,00 |
| -K... | Kopf in P = poliert SM = schwarz matt SG = schwarz glanz WM = weiß matt WG = weiß glanz head in P = polished SM = black matt SG = black glossy WM = white matt WG = white glossy | | |
| -PT... | Pendelkabel Textil S = schwarz R = rot W = weiß pendant lead textile S = black R = red W = white | | |
| -PSO | Pendelkabel Textil Sonderfarbe Aufpreis je Pendel pendant lead textile special color additional charge each pendant | +84,03 | +100,00 |

DR-Z



Typ

DR. WATTSON Nachttisch mit ausdrehbarem Staufach und ZEUS Flexarmleuchte /// Leuchtkopf aus massivem Aluminium mit 15–75° stufenlos einstellbarem Abstrahlwinkel /// robuste Flexwelle mit gebürsteter Aluminiumoberfläche oder farbigem Textilüberzug /// weiß gepulverter Aluminium Wandhalterung mit Staufach aus massivem Eichenholz

Dimmung

Tastdimmer am Sockel

Abmessung

Leuchte: Höhe max. 55 cm / Flexwelle 45 cm / Kopf Ø 3 cm
Nachttisch: L30 x B22 x H5 cm

Lieferung

inkl. USB Steckernetzteil, Schrauben

type

DR. WATTSON bedside table with rotatable compartment and ZEUS flex light /// lamp head made of solid aluminium with 15–75° infinitely focusable angle beam /// strong flexible shaft in brushed aluminium or colored textile coating /// wall fitting made of white powder-coated aluminium with compartment made of massive oak wood

dimming

base dimmer switch

dimension

light: height max. 55 cm / flex 45 cm / head Ø 3 cm
bedside table: L30 x W22 x H5 cm

delivery

incl. USB plug transformer, screws

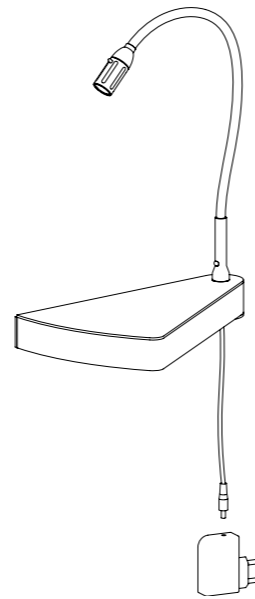

| | | EUR | +19% |
|---------------|---|--------|---------------|
| DR-Z | | 461,34 | 549,00 |
| -KA | Kopf und Rohr in Alu head and tube in alu | | |
| -KS | Kopf und Rohr in schwarz head and tube in black | +42,02 | +50,00 |
| -FA | Flexwelle mit gebürsteter Aluminiumoberfläche flexible shaft in alu brush-finished | | |
| -FT... | Flexwelle Textil S = schwarz R = rot A = anthrazit W = weiß G = grün U = braun B = blau flexible shaft textile S = black R = red A = anthracite W = white G = green U = brown B = blue | | |
| -FSO | Flexwelle in Sonderfarbe / Welle kürzen / Welle verlängern (auf max. 100 cm), Aufpreis flexible shaft in special color / to cut short / to extend (max. 100 cm), extra charge | +42,02 | +50,00 |

DR-A



Typ

DR. WATTSON Nachttisch mit ausdrehbarem Staufach und ATHENE Flexarmleuchte /// Leuchtkopf aus massivem Aluminium mit 25–100° stufenlos einstellbarem Abstrahlwinkel /// robuste Flexwelle mit gebürsteter Aluminiumoberfläche oder farbigem Textilüberzug /// weiß gepulverter Aluminium Wandhalterung mit Staufach aus massivem Eichenholz

Dimmung

Tastdimmer am Sockel

Abmessung

Leuchte: Höhe max. 55 cm / Flexwelle 45 cm / Kopf Ø 6,5 cm
Nachttisch: L30 x B22 x H5 cm

Lieferung

inkl. USB Steckernetzteil, Schrauben

type

DR. WATTSON bedside table with ATHENE flex light /// lamp head made of solid aluminium with 25–100° infinitely focusable angle beam /// strong flexible shaft in brushed aluminium or colored textile coating /// wall fitting in white powder-coated aluminium with compartment made of massive oak wood

dimming

base dimmer switch

dimension

light: height max. 55 cm / flex 45 cm / head Ø 6,5 cm
bedside table: L30 x W22 x H5 cm

delivery

incl. USB plug transformer, screws

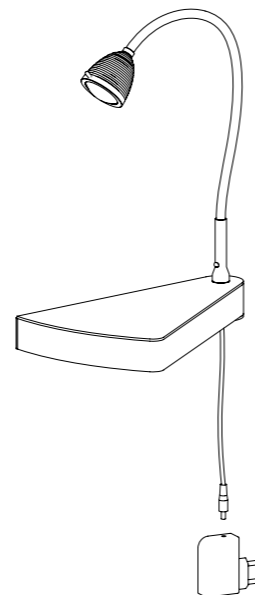

| | | EUR | +19% |
|---------------|---|--------|---------------|
| DR-A | | 503,36 | 599,00 |
| -KA | Kopf und Rohr in Alu head and tube in alu | | |
| -KS | Kopf und Rohr in schwarz head and tube in black | +42,02 | +50,00 |
| -FA | Flexwelle mit gebürsteter Aluminiumoberfläche flexible shaft in alu brush-finished | | |
| -FT... | Flexwelle Textil S = schwarz R = rot A = anthrazit W = weiß G = grün U = braun B = blau flexible shaft textile S = black R = red A = anthracite W = white G = green U = brown B = blue | | |
| -FSO | Flexwelle in Sonderfarbe / Welle kürzen / Welle verlängern (auf max. 100 cm), Aufpreis flexible shaft in special color / to cut short / to extend (max. 100 cm), extra charge | +42,02 | +50,00 |





Typ

EICHENDORFF Nachttisch mit ZEUS Flexarmleuchte /// Leuchtkopf aus massivem Aluminium mit 15–75° stufenlos einstellbarem Abstrahlwinkel /// robuste Flexwelle mit gebürsteter Aluminiumoberfläche oder farbigem Textilüberzug /// Nachttisch aus massivem Multiplexholz mit seidenmatt weißer Beschichtung /// Spiegelverkehrt montierbar /// Ausziehbares Lesezeichen aus satiniertem Edelstahl

Dimmung

Tastdimmer am Sockel

Abmessung

Leuchte: Höhe max. 55 cm / Flexwelle 45 cm / Kopf Ø 3 cm
Nachttisch: L34 x B22 x H12 cm

Lieferung

inkl. USB Steckernetzteil, Schrauben

type

EICHENDORFF bedside table with ZEUS flex light /// lamp head made of solid aluminium with 15–75° infinitely focusable angle beam /// strong flexible shaft in brushed aluminium or colored textile coating /// bedside table made of massive multiplex wood with satin white surface finishing /// mirrored installation possible /// extendable bookmark made of satined stainless steel possible

dimming

base dimmer switch

dimension

light: height max. 55 cm / flex 45 cm / head Ø 3 cm
bedside table: L34 x W22 x H12 cm

delivery

incl. USB plug transformer, screws

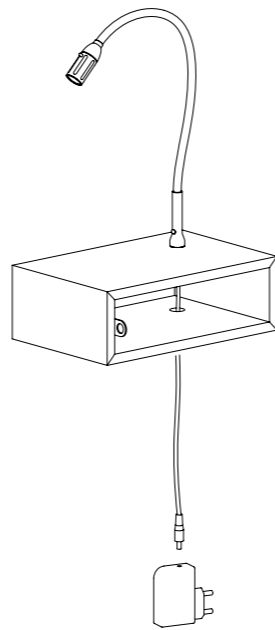

| | | EUR | +19% |
|--------|---|--------|--------|
| EI-Z | | 377,31 | 449,00 |
| -KA | Kopf und Rohr in Alu head and tube in alu | | |
| -KS | Kopf und Rohr in schwarz head and tube in black | +42,02 | +50,00 |
| -FA | Flexwelle mit gebürsteter Aluminiumoberfläche flexible shaft in alu brush-finished | | |
| -FT... | Flexwelle Textil S = schwarz R = rot A = anthrazit W = weiß G = grün U = braun B = blau flexible shaft textile S = black R = red A = anthracite W = white G = green U = brown B = blue | | |
| -FSO | Flexwelle in Sonderfarbe / Welle kürzen / Welle verlängern (auf max. 100 cm), Aufpreis flexible shaft in special color / to cut short / to extend (max. 100 cm), extra charge | +42,02 | +50,00 |



Typ

EICHENDORFF Nachttisch und ATHENE Flexarmleuchte /// Leuchtkopf aus massivem Aluminium mit 25–100° stufenlos einstellbarem Abstrahlwinkel /// robuste Flexwelle mit gebürsteter Aluminiumoberfläche oder farbigem Textilüberzug /// Nachttisch aus massivem Multiplexholz mit seidenmatt weißer Beschichtung /// links und rechts montierbar /// ausziehbares Lesezeichen aus satiniertem Edelstahl

Dimmung

Tastdimmer am Sockel

Abmessung

Leuchte: Höhe max. 55 cm / Flexwelle 45 cm / Kopf Ø 6,5 cm
Nachttisch: L34 x B22 x H12 cm

Lieferung

inkl. USB Steckernetzteil, Schrauben

type

EICHENDORFF bedside table with ATHENE flex light /// lamp head made of solid aluminium with 25–100° infinitely focusable angle beam /// strong flexible shaft in brushed aluminium or colored textile coating /// bedside table in massive multiplex wood with satin white surface finishing /// installation left and right /// extendable bookmark made of satined stainless steel possible

dimming

base dimmer switch

dimension

light: height max. 55 cm / flex 45 cm / head Ø 6,5 cm
bedside table: L34 x W22 x H12 cm

delivery

incl. USB plug transformer, screws

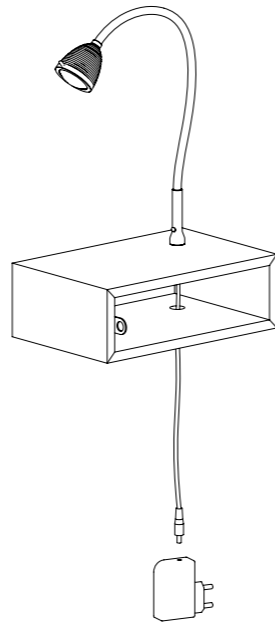

| | | EUR | +19% |
|--------|---|--------|--------|
| EI-A | | 419,33 | 499,00 |
| -KA | Kopf und Rohr in Alu head and tube in alu | | |
| -KS | Kopf und Rohr in schwarz head and tube in black | +42,02 | +50,00 |
| -FA | Flexwelle mit gebürsteter Aluminiumoberfläche flexible shaft in alu brush-finished | | |
| -FT... | Flexwelle Textil S = schwarz R = rot A = anthrazit W = weiß G = grün U = braun B = blau flexible shaft textile S = black R = red A = anthracite W = white G = green U = brown B = blue | | |
| -FSO | Flexwelle in Sonderfarbe / Welle kürzen / Welle verlängern (auf max. 100 cm), Aufpreis flexible shaft in special color / to cut short / to extend (max. 100 cm), extra charge | +42,02 | +50,00 |





Typ

KIPPLING Bücherregal mit ZEUS Flexarmleuchte /// Leuchtkopf aus massivem Aluminium mit 15–75° stufenlos einstellbarem Abstrahlwinkel /// robuste Flexwelle mit gebürsteter Aluminiumoberfläche oder farbigem Textilüberzug /// Regal aus massivem Multiplexholz mit seidenmatt weißer Beschichtung

Dimmung

Tastdimmer am Sockel

Abmessung

Leuchte: Höhe max. 55 cm / Flexwelle 45 cm / Kopf Ø 3 cm
Regal: L58 x B15 x H14 cm

Lieferung

inkl. USB Steckernetzteil, Schrauben

type

KIPPLING bookshelf with flex light /// lamp head made of solid aluminium with 15–75° infinitely focusable angle beam /// strong flexible shaft in brushed aluminium or colored textile coating /// shelf made of massive multiplex wood with satin white surface finishing

dimming

base dimmer switch

dimension

light: height max. 55 cm / flex 45 cm / head Ø 3 cm
shelf: L58 x W15 x H14 cm

delivery

incl. USB plug transformer, screws

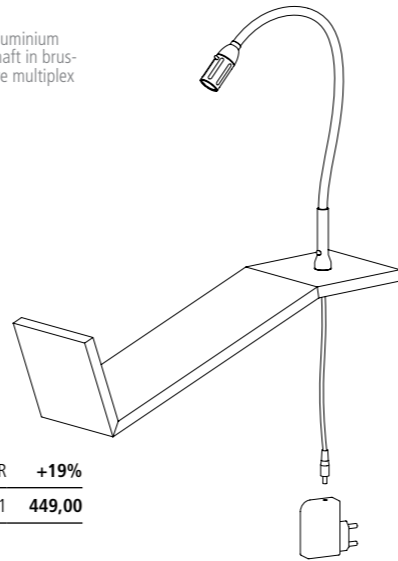

| | | EUR | +19% |
|--------|---|--------|--------|
| KI-Z | | 377,31 | 449,00 |
| -KA | Kopf und Rohr in Alu head and tube in alu | | |
| -KS | Kopf und Rohr in schwarz head and tube in black | +42,02 | +50,00 |
| -FA | Flexwelle mit gebürsteter Aluminiumoberfläche flexible shaft in alu brush-finished | | |
| -FT... | Flexwelle Textil S = schwarz R = rot A = anthrazit W = weiß G = grün U = braun B = blau flexible shaft textile S = black R = red A = anthracite W = white G = green U = brown B = blue | | |
| -FSO | Flexwelle in Sonderfarbe / Welle kürzen / Welle verlängern (auf max. 100 cm), Aufpreis flexible shaft in special color / to cut short / to extend (max. 100 cm), extra charge | +42,02 | +50,00 |



Typ

KIPPLING Bücherregal mit ATHENE Flexarmleuchte /// Leuchtkopf aus massivem Aluminium mit 25–100° stufenlos einstellbarem Abstrahlwinkel /// robuste Flexwelle mit gebürsteter Aluminiumoberfläche oder farbigem Textilüberzug /// Regal aus massivem Multiplexholz mit seidenmatt weißer Beschichtung

Dimmung

Tastdimmer am Sockel

Abmessung

Leuchte: Höhe max. 55 cm / Flexwelle 45 cm / Kopf Ø 6,5 cm
Regal: L58 x B15 x H14 cm

Lieferung

inkl. USB Steckernetzteil, Schrauben

type

KIPPLING bookshelf with ATHENE flex light /// lamp head made of solid aluminium with 25–100° infinitely focusable angle beam /// strong flexible shaft in brushed aluminium or colored textile coating /// shelf made of massive multiplex wood with satin white surface finishing

dimming

base dimmer switch

dimension

light: height max. 55 cm / flex 45 cm / head Ø 6,5 cm
shelf: L58 x W15 x H14 cm

delivery

incl. USB plug transformer, screws

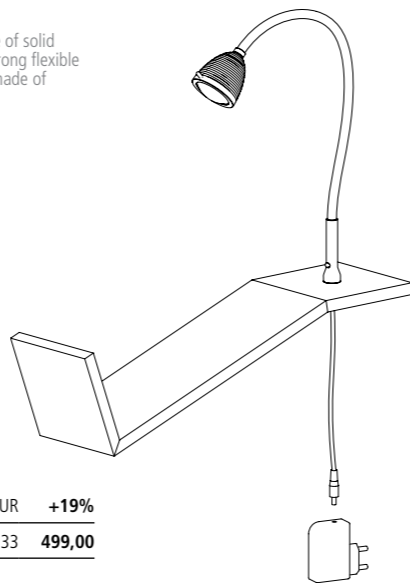

| | | EUR | +19% |
|--------|---|--------|--------|
| KI-A | | 419,33 | 499,00 |
| -KA | Kopf und Rohr in Alu head and tube in alu | | |
| -KS | Kopf und Rohr in schwarz head and tube in black | +42,02 | +50,00 |
| -FA | Flexwelle mit gebürsteter Aluminiumoberfläche flexible shaft in alu brush-finished | | |
| -FT... | Flexwelle Textil S = schwarz R = rot A = anthrazit W = weiß G = grün U = braun B = blau flexible shaft textile S = black R = red A = anthracite W = white G = green U = brown B = blue | | |
| -FSO | Flexwelle in Sonderfarbe / Welle kürzen / Welle verlängern (auf max. 100 cm), Aufpreis flexible shaft in special color / to cut short / to extend (max. 100 cm), extra charge | +42,02 | +50,00 |





Typ

KIPPLING Bücherregal mit FYPS Tischleuchte /// Leuchtkopf aus massivem Aluminium mit 100° Abstrahlwinkel /// Regal aus massivem Multiplexholz mit seidenmatt weißer Beschichtung

Dimmung

Handdimmer

Abmessung

Leuchtkopf: Ø 6 cm
Regal: L58 x B15 x H14 cm

Lieferung

inkl. 230 V Zuleitung mit Schuko stecker, Schrauben

type

KIPPLING book shelf with FYPS table light /// lamp head made of solid aluminium with 100° angle beam /// shelf made of massive multiplex wood with satin white surface finishing

dimming

hand dimmer switch

dimension

lamp head: Ø 6 cm
shelf: L58 x W15 x H14 cm

delivery

incl. 230 V power with schuko plug, screws

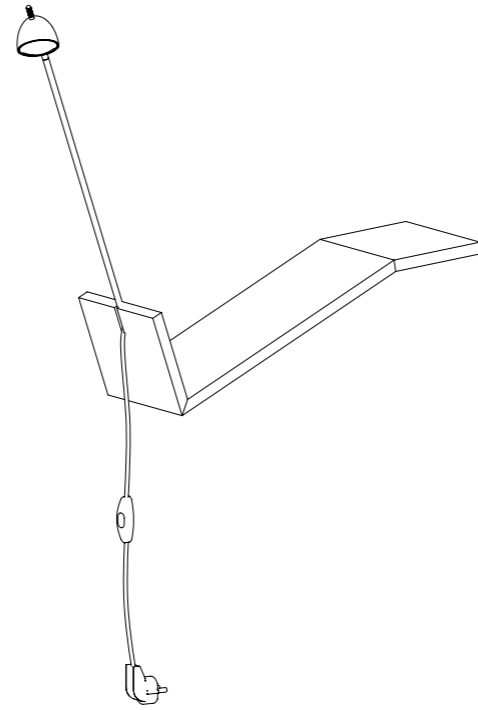

EUR +19%

| | | |
|------|--------|--------|
| KI-F | 335,29 | 399,00 |
|------|--------|--------|



Typ

KIPPLING Bücherregal mit MIMIX Einbaustrahler /// Leuchtkopf aus massivem Aluminium mit 100° Abstrahlwinkel /// Regal aus massivem Multiplexholz mit seidenmatt weißer Beschichtung /// optional dim2warm LED auf Anfrage

Dimmung

Handdimmer

Abmessung

Leuchtkopf: Ø 6 cm
Regal: L58 x B15 x H14 cm

Lieferung

inkl. 230 V Zuleitung mit Schuko stecker, Schrauben

type

KIPPLING book shelf with MIMIX downlight /// lamp head made of solid aluminium with 100° angle beam /// shelf made of massive multiplex wood with satin white surface finishing /// optional dim2warm LED on demand

dimming

hand dimmer switch

dimension

lamp head: Ø 6 cm
shelf: L58 x W15 x H14 cm

delivery

incl. 230 V power with schuko plug, screws

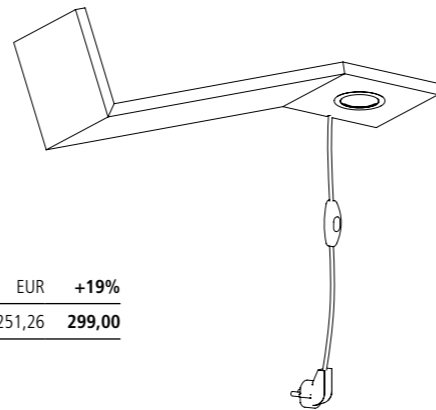

EUR +19%

| | | |
|------|--------|--------|
| KI-M | 251,26 | 299,00 |
|------|--------|--------|



Typ

AICHINGER Bücherregal mit MIMIX Einbaustrahler /// Leuchtkopf aus massivem Aluminium mit 100° Abstrahlwinkel /// Regal aus massivem Eichenholz /// Lesezeichen aus satiniertem Edelstahl /// optional dim2warm LED auf Anfrage

Dimmung

Handdimmer

Abmessung

Leuchtkopf: Ø 6 cm
Regal: L45 x B15 x H5 cm

Lieferung

inkl. 230 V Zuleitung mit Schuko stecker, Schrauben

type

AICHINGER book shelf with MIMIX downlight /// lamp head made of solid aluminium with 100° angle beam /// shelf in massive multiplex wood /// extendable bookmark made of satined stainless steel /// optional dim2warm LED on demand

dimming

hand dimmer switch

dimension

lamp head: Ø 6 cm
shelf: L45 x W15 x H5 cm

delivery

incl. 230 V power with schuko plug, screws

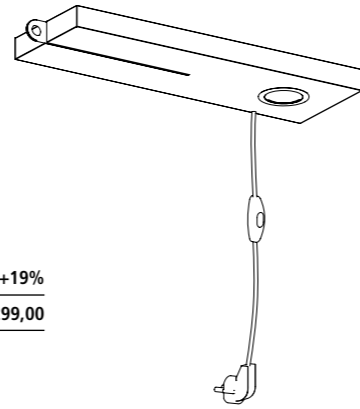

EUR +19%

AI-M 251,26 **299,00**



AI-Z



Typ

AICHINGER Bücherregal mit ZEUS Flexarmleuchte /// Leuchtkopf aus massivem Aluminium mit 15–75° stufenlos einstellbarem Abstrahlwinkel /// robuste Flexwelle mit gebürsteter Aluminiumoberfläche oder farbigem Textilüberzug /// Regal aus massivem Eichenholz /// Lesezeichen aus satiniertem Edelstahl

Dimmung

Tastdimmer am Sockel

Abmessung

Leuchte: Höhe max. 55 cm / Flexwelle 45 cm / Kopf Ø 3 cm
Regal: L45 x B15 x H5 cm

Lieferung

inkl. USB Steckernetzteil, Schrauben

type

AICHINGER bedshelf with ZEUS flex light /// lamp head made of solid aluminium with 15–75° infinitely focusable angle beam /// strong flexible shaft in brushed aluminium or colored textile coating /// shelf made of massive oak wood /// extendable bookmark made of satined stainless steel

dimming

base dimmer switch

dimension

light: height max. 55 cm / flex 45 cm / head Ø 3 cm
shelf: L45 x W15 x H5 cm

delivery

incl. USB plug transformer, screws

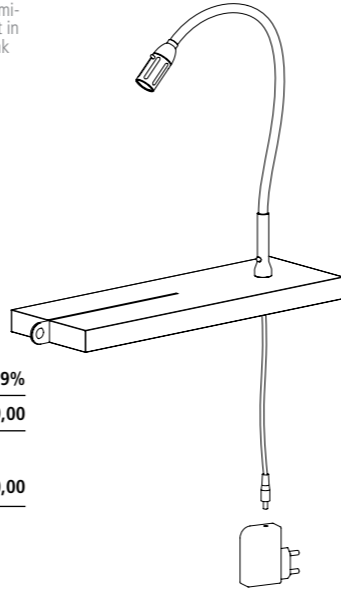

| | | EUR | +19% |
|--------|---|--------|--------|
| AI-Z | | 377,31 | 449,00 |
| -KA | Kopf und Rohr in Alu head and tube in alu | | |
| -KS | Kopf und Rohr in schwarz head and tube in black | +42,02 | +50,00 |
| -FA | Flexwelle mit gebürsteter Aluminiumoberfläche flexible shaft in alu brush-finished | | |
| -FT... | Flexwelle Textil S = schwarz R = rot A = anthrazit W = weiß G = grün U = braun B = blau flexible shaft textile S = black R = red A = anthracite W = white G = green U = brown B = blue | | |
| -FSO | Flexwelle in Sonderfarbe / Welle kürzen / Welle verlängern (auf max. 100 cm), Aufpreis flexible shaft in special color / to cut short / to extend (max. 100 cm), extra charge | +42,02 | +50,00 |

Z-ATL



Typ

Tischbauleuchte mit Leuchtkopf und Sockel aus massivem Aluminium /// 15–75° stufenlos einstellbarer Abstrahlwinkel durch Linsenoptik /// robuste Flexwelle mit gebürsteter Aluminiumoberfläche oder farbigem Textilüberzug

Montage

an Ø 22 mm Bohrung

Dimmung

Tastdimmer am Sockel

Abmessung

ATL1: Höhe max. 65 cm / Flexwelle 45 cm / Kopf Ø 3 cm

Lieferung

inkl. USB Steckernetzteil

type

table build-in light with lamp head and base made of solid aluminium /// lens optics with 15–75° infinitely focusable angle beam /// strong flexible shaft in brushed aluminium or colored textile coating

installation

at Ø 22 mm bore hole

dimming

base dimmer switch

dimension

ATL1: height up to 65 cm / flex 45 cm / head Ø 3 cm

delivery

incl. USB plug transformer

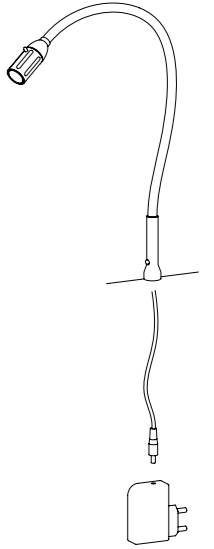

| | | EUR | +19% |
|--------|---|--------|--------|
| Z-ATL1 | | 289,91 | 349,00 |
| -KA | Kopf und Rohr in Alu head and tube in alu | | |
| -KS | Kopf und Rohr in schwarz head and tube in black | +42,02 | +50,00 |
| -FA | Flexwelle mit gebürsteter Aluminiumoberfläche flexible shaft in alu brush-finished | | |
| -FT... | Flexwelle Textil S = schwarz R = rot A = anthrazit W = weiß G = grün U = braun B = blau flexible shaft textile S = black R = red A = anthracite W = white G = green U = brown B = blue | | |
| -FSO | Flexwelle in Sonderfarbe / Welle kürzen / Welle verlängern (auf max. 100 cm), Aufpreis flexible shaft in special color / to cut short / to extend (max. 100 cm), extra charge | +42,02 | +50,00 |
| -R... | Rändelmutter für Materialstärke R10 (5–11 mm) R24 (18–24 mm) R34 (29–35 mm) R50 (45–51 mm) nut for material thickness R10 (5–11 mm) R24 (18–24 mm) R34 (29–35 mm) R50 (45–51 mm) | | |



AI-A



Typ

AICHINGER Bücherregal mit ATHENE Flexarmleuchte /// Leuchtkopf aus massivem Aluminium mit 25–100° stufenlos einstellbarem Abstrahlwinkel /// robuste Flexwelle mit gebürsteter Aluminiumoberfläche oder farbigem Textilüberzug /// Regal aus massivem Eichenholz /// Lesezeichen aus satiniertem Edelstahl

Dimmung

Tastdimmer am Sockel

Abmessung

Leuchte: Höhe max. 55 cm / Flexwelle 45 cm / Kopf Ø 6,5 cm
Regal: L45 x B15 x H5 cm

Lieferung

inkl. USB Steckernetzteil, Schrauben

type

AICHINGER book shelf with ATHENE flex light /// lamp head made of solid aluminium with 25–100° infinitely focusable angle beam /// strong flexible shaft in brushed aluminium or colored textile coating /// shelf made of massive oak wood /// extendable bookmark made of satined stainless steel

dimming

base dimmer switch

dimension

light: height max. 55 cm / flex 45 cm / head Ø 6,5 cm
shelf: L45 x W15 x H5 cm

delivery

incl. USB plug transformer, screws

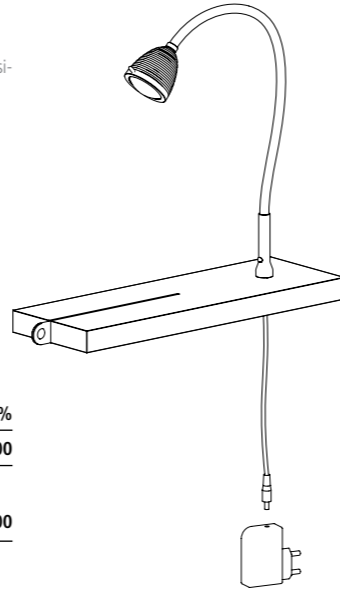

| | | EUR | +19% |
|--------|---|--------|--------|
| AI-A | | 419,33 | 499,00 |
| -KA | Kopf und Rohr in Alu head and tube in alu | | |
| -KS | Kopf und Rohr in schwarz head and tube in black | +42,02 | +50,00 |
| -FA | Flexwelle mit gebürsteter Aluminiumoberfläche flexible shaft in alu brush-finished | | |
| -FT... | Flexwelle Textil S = schwarz R = rot A = anthrazit W = weiß G = grün U = braun B = blau flexible shaft textile S = black R = red A = anthracite W = white G = green U = brown B = blue | | |
| -FSO | Flexwelle in Sonderfarbe / Welle kürzen / Welle verlängern (auf max. 100 cm), Aufpreis flexible shaft in special color / to cut short / to extend (max. 100 cm), extra charge | +42,02 | +50,00 |

A-ATL



Typ

Tischeinbauleuchte mit Leuchtkopf und Rohr aus massivem Aluminium /// 25–100° stufenlos einstellbarer Abstrahlwinkel durch Glaslinsenoptik /// robuste Flexwelle mit gebürsteter Aluminiumoberfläche oder farbigem Textilüberzug

Montage

an Ø 22 mm Bohrung

Dimmung

Tastdimmer am Sockel

Abmessung

ATL1: Höhe max. 65 cm / Flexwelle 45 cm / Kopf Ø 6,5 cm
ATL2: Höhe max. 85 cm / Flexwelle 45 cm / Kopf Ø 6,5 cm

Lieferung

inkl. USB Steckernetzteil

type

table build-in light with lamp head and tube made of solid aluminium /// glass lens optics with 25–100° infinitely focusable angle beam /// strong flexible shaft in brushed aluminium or colored textile coating

installation

at Ø 22 mm bore hole

dimming

base dimmer switch

dimension

ATL1: height up to 65 cm / flex 45 cm / head Ø 6,5 cm
ATL2: height up to 85 cm / flex 45 cm / head Ø 6,5 cm

delivery

incl. USB plug transformer

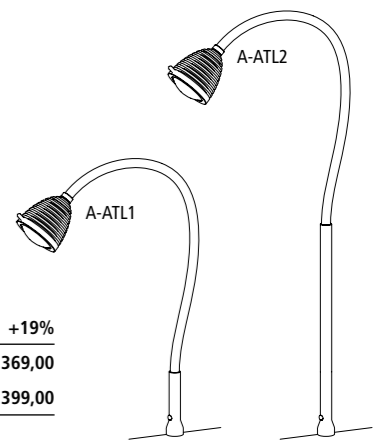

| | | EUR | +19% |
|--------|---|--------|--------|
| A-ATL1 | | 310,08 | 369,00 |
| A-ATL2 | | 335,29 | 399,00 |
| -KA | Kopf und Rohr in Alu head and tube in alu | | |
| -KS | Kopf und Rohr in schwarz head and tube in black | +42,02 | +50,00 |
| -FA | Flexwelle mit gebürsteter Aluminiumoberfläche flexible shaft in alu brush-finished | | |
| -FT... | Flexwelle Textil S = schwarz R = rot A = anthrazit W = weiß G = grün U = braun B = blau flexible shaft textile S = black R = red A = anthracite W = white G = green U = brown B = blue | | |
| -FSO | Flexwelle in Sonderfarbe / Welle kürzen / Welle verlängern (auf max. 100 cm), Aufpreis flexible shaft in special color / to cut short / to extend (max. 100 cm), extra charge | +42,02 | +50,00 |
| -R... | Rändelmutter für Materialstärke R10 (5–11 mm) R24 (18–24 mm) R34 (29–35 mm) R50 (45–51 mm) nut for material thickness R10 (5–11 mm) R24 (18–24 mm) R34 (29–35 mm) R50 (45–51 mm) | | |



Typ

BOOKOWSKI mobiler Buchständer mit ATHENE Akku Standleuchte /// Leuchtkopf aus massivem Aluminium mit 25–100° stufenlos einstellbarem Abstrahlwinkel /// robuste Flexwelle mit gebürsteter Aluminiumoberfläche oder farbigem Textilüberzug /// Buchständer aus massivem Eichenholz mit satiniertes Edelstahlplatte und Gummirädern /// wechselbarer Li-Ionen Akkupack im Korpus /// Leuchtdauer Akku > 6 Std.

Dimmung

Tastdimmer am Rohr

Abmessung

Leuchte: Höhe max. 145 cm / Flexwelle 45 cm / Kopf Ø 6,5 cm
Buchständer: L38 x B25 x H30 cm

Lieferung

inkl. Steckerladegerät, Akku

type

BOOKOWSKI mobile book stand with ATHENE rechargeable battery pack floor light /// lamp head solid aluminium with 25–100° infinitely focusable angle beam /// strong flexible shaft in brushed aluminium or colored textile coating /// book stand made of massive oak wood with satined stainless steel shelf-board and rubber wheels /// exchangeable lithium-ion rechargeable pack inside corpus /// operation time > 6 hrs.

dimming

tube dimmer switch

dimension

light: height max. 145 cm / flex 45 cm / head Ø 6,5 cm
standing: L38 x W25 x H30 cm

delivery

incl. plug charger, rechargeable battery pack

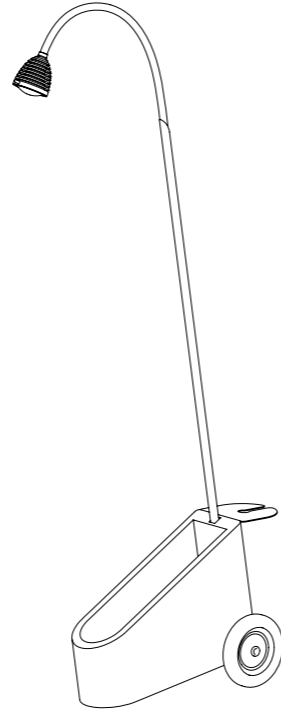

| | | EUR | +19% |
|--------|---|--------|----------|
| BO-A | | 923,53 | 1.099,00 |
| -KA | Kopf und Rohr in Alu head and tube in alu | | |
| -KS | Kopf und Rohr in schwarz head and tube in black | +42,02 | +50,00 |
| -FA | Flexwelle mit gebürsteter Aluminiumoberfläche flexible shaft in alu brush-finished | | |
| -FT... | Flexwelle Textil S = schwarz R = rot A = anthrazit W = weiß G = grün U = braun B = blau flexible shaft textile S = black R = red A = anthracite W = white G = green U = brown B = blue | | |
| -FSO | Flexwelle in Sonderfarbe / Welle kürzen / Welle verlängern (auf max. 100 cm), Aufpreis flexible shaft in special color / to cut short / to extend (max. 100 cm), extra charge | +42,02 | +50,00 |



LÄ-A



Typ

LÄSSING Buchständer mit ATHENE Standleuchte /// Leuchtkopf aus massivem Aluminium mit 25–100° stufenlos einstellbarem Abstrahlwinkel /// robuste Flexwelle mit gebürsteter Aluminiumoberfläche oder farbigem Textilüberzug /// Buchständer aus massivem Multiplexholz mit seidenmatt weißer Beschichtung /// beidseitig ansteckbares Tablar aus satiniertem Edelstahl mit einseitiger Filzbeschichtung

Dimmung

Tastdimmer am Rohr

Abmessung

Leuchte: Höhe max. 145 cm / Flexwelle 45 cm / Kopf Ø 6,5 cm
Buchständer: L37 x B21 x H39 cm

Lieferung

inkl. USB Steckernetzteil

type

LÄSSING book stand with ATHENE floor light /// lamp head made of aluminium with 25–100° infinitely focusable angle beam /// strong flexible shaft in brushed aluminium or colored textile coating /// book stand made of massive multiplex wood with satin white surface finishing /// both-sided attachable shelf board made of satined stainless steel with one-sided wool felt

dimming

tube dimmer switch

dimension

light: height max. 145 cm / flex 45 cm / head Ø 6,5 cm
standing: L37 x W21 x H39 cm

delivery

incl. USB plug transformer

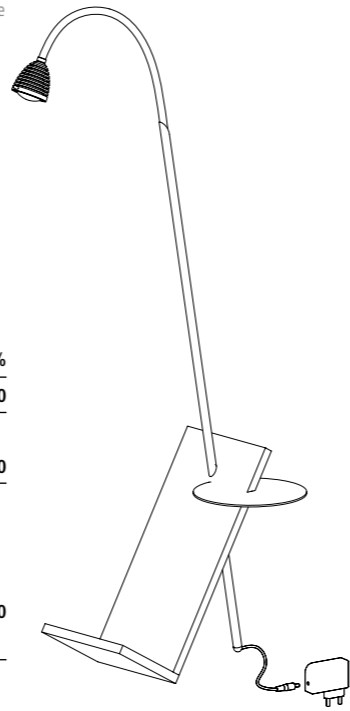

| | | EUR | +19% |
|--------|---|--------|--------|
| LÄ-A | | 503,36 | 599,00 |
| -KA | Kopf und Rohr in Alu head and tube in alu | | |
| -KS | Kopf und Rohr in schwarz head and tube in black | +42,02 | +50,00 |
| -FA | Flexwelle mit gebürsteter Aluminiumoberfläche flexible shaft in alu brush-finished | | |
| -FT... | Flexwelle Textil S = schwarz R = rot A = anthrazit W = weiß G = grün U = braun B = blau flexible shaft textile S = black R = red A = anthracite W = white G = green U = brown B = blue | | |
| -FSO | Flexwelle in Sonderfarbe / Welle kürzen / Welle verlängern (auf max. 100 cm), Aufpreis flexible shaft in special color / to cut short / to extend (max. 100 cm), extra charge | +42,02 | +50,00 |

LÄ-Y



Typ

LÄSSING Buchständer mit YLUX Standleuchte /// Leuchtkopf aus massivem Aluminium mit 50–100° stufenlos einstellbarem Abstrahlwinkel /// höhenverstellbares Teleskoprohr mit Lederschlaufe /// Buchständer aus massivem Multiplexholz mit seidenmatt weißer Beschichtung /// beidseitig ansteckbares Tablar aus satiniertem Edelstahl mit einseitiger Filzbeschichtung

Dimmung

Drehdimmer am Leuchtkopf

Abmessung

Leuchte: Höhe max. 140 cm / Teleskop 75–140 cm / Kopf Ø 9 cm / Standfuß Ø 23 cm
Buchständer: L37 x B21 x H39 cm

Lieferung

inkl. Schnurnetzteil

type

LÄSSING book stand with YLUX floor light /// lamp head made of solid aluminium with 50–100° infinitely focusable angle beam /// height adjustable telescope tube with leather loop /// book stand in solid multiplex wood with satin white surface finishing /// both-sided attachable shelf board made of satined stainless steel with one-sided wool felt

dimming

rotary dimmer switch at lamp head

dimension

light: height max. 140 cm / telescope 75–140 cm / head Ø 9 cm / stand Ø 23 cm
standing: L37 x W21 x H39 cm

delivery

incl. lead transformer

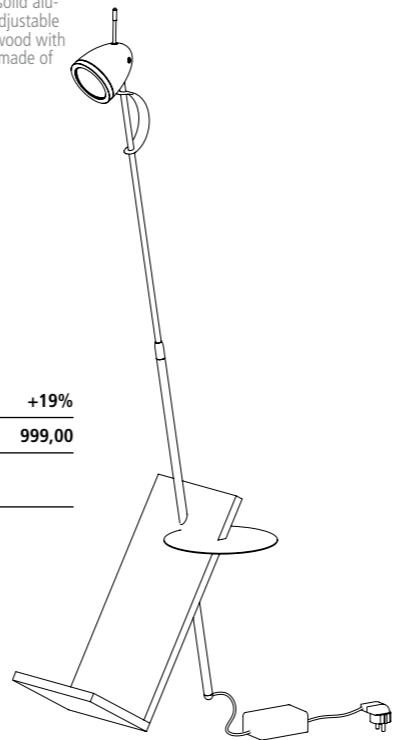

| | | EUR | +19% |
|-------|---|--------|--------|
| LÄ-Y | | 839,49 | 999,00 |
| -K... | Kopf in P = poliert SM = schwarz matt SG = schwarz glanz WM = weiß matt WG = weiß glanz head in P = polished SM = black matt SG = black glossy WM = white matt WG = white glossy | | |





Typ

JULES VERNE rollbarer Buchständer mit YLUX Akku Standleuchte /// Leuchtkopf aus massivem Aluminium mit 25–100° stufenlos einstellbarem Abstrahlwinkel /// höhenverstellbares Teleskoprohr mit Lederschlaufe /// Korpus aus massivem Eichenholz mit Aluminium Rollen und Lederriemen /// wechselbarer Li-Ionen Akkupack im Korpus /// Leuchtdauer Akku > 6 Std.

Dimmung

Tastdimmer am Leuchtkopf

Abmessung

Höhe 140 cm / Teleskop 75–140 cm / Kopf Ø 9 cm / Korpus 22 x 27 cm

Lieferung

inkl. Steckerladegerät, Akku

type

JULES VERNE rollable book stand with YLUX rechargeable battery pack floor light /// lamp head made of solid aluminium with 25–100° infinitely focusable angle beam /// height adjustable telescope tube with leather loop /// corpus made of massive oak wood with aluminium wheels and leather belt /// exchangeable lithium-ion rechargeable pack inside corpus /// operation time > 6 hrs.

dimming

dimmer switch at lamp head

dimension

height 140 cm / telescope 75–140 cm / head Ø 9 cm / corpus 22 x 27 cm

delivery

incl. plug charger, rechargeable battery pack

EUR +19%

JU-Y 1.007,56 **1.199,00**

-K... Kopf in **P** = poliert **SM** = schwarz matt **SG** = schwarz glanz **WM** = weiß matt **WG** = weiß glanz
head in **P** = polished **SM** = black matt **SG** = black glossy **WM** = white matt **WG** = white glossy

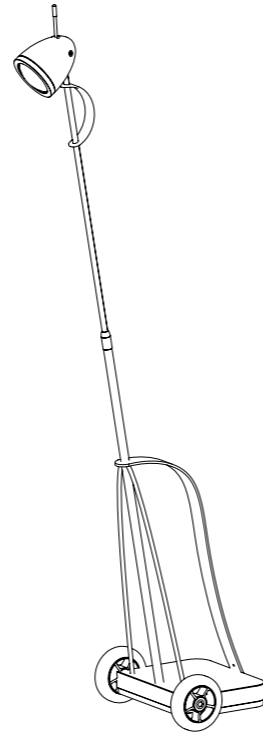

RI-A



Typ

RINGELNATZ Couchtisch mit ATHENE Standleuchte /// Leuchtkopf aus massivem Aluminium mit 25–100° stufenlos einstellbarem Abstrahlwinkel /// robuste Flexwelle mit gebürsteter Aluminiumoberfläche oder farbigem Textilüberzug /// Tischplatte aus seidenmatt weiß lackiertem MDF Holz /// Standbeine aus massivem Eichenholz

Dimmung

Tastdimmer am Rohr

Abmessung

Leuchte: Höhe max. 145 cm / Flexwelle 45 cm / Kopf Ø 6,5 cm
Tisch: L38 x B38 x H40 cm

Lieferung

inkl. USB Steckernetzteil

type

RINGELNATZ couch table with ATHENE floor light /// lamp head made of aluminium with 25–100° infinitely focusable angle beam /// strong flexible shaft in brushed aluminium or colored textile coating /// tabletop made of satin white MDF wood /// table legs in massive oak wood

dimming

tube dimmer switch

dimension

light: height max. 145 cm / flex 45 cm / head Ø 6,5 cm
table: L38 x W38 x H40 cm

delivery

incl. USB plug transformer

| | | EUR | +19% |
|--------|---|--------|--------|
| RI-A | | 630,25 | 750,00 |
| -KA | Kopf und Rohr in Alu head and tube in alu | | |
| -KS | Kopf und Rohr in schwarz head and tube in black | +42,02 | +50,00 |
| -FA | Flexwelle mit gebürsteter Aluminiumoberfläche flexible shaft in alu brush-finished | | |
| -FT... | Flexwelle Textil S = schwarz R = rot A = anthrazit W = weiß G = grün U = braun B = blau flexible shaft textile S = black R = red A = anthracite W = white G = green U = brown B = blue | | |
| -FSO | Flexwelle in Sonderfarbe / Welle kürzen / Welle verlängern (auf max. 100 cm), Aufpreis flexible shaft in special color / to cut short / to extend (max. 100 cm), extra charge | +42,02 | +50,00 |

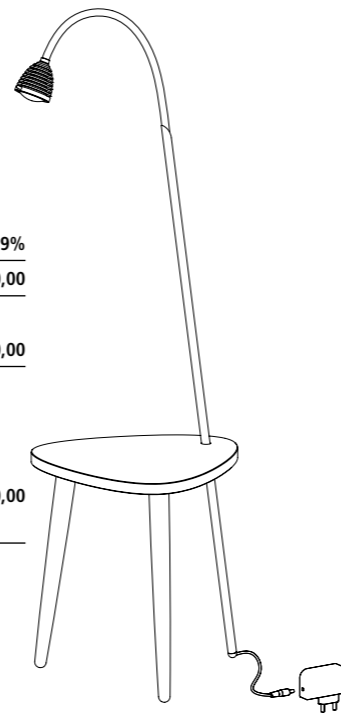

RI-Y



Typ

RINGELNATZ Couchtisch mit YLUX Standleuchte /// Leuchtkopf aus massivem Aluminium mit 50–100° stufenlos einstellbarem Abstrahlwinkel /// Standrohr mit Gelenkarm und Lederschlaufe /// Tischplatte aus seidenmatt weiß lackiertem MDF Holz /// Standbeine aus massivem Eichenholz

Dimmung

Drehdimmer am Leuchtkopf

Abmessung

Leuchte: Höhe max. 140 cm / Teleskop 75–140 cm / Kopf Ø 9 cm / Standfuß Ø 23 cm
Tisch: L38 x B38 x H40 cm

Lieferung

inkl. Schnurnetzteil

type

RINGELNATZ couch table with YLUX floor light /// lamp head made of solid aluminium with 50–100° infinitely focusable angle beam /// standing with hinged bracket and leather loop /// tabletop made of satin white MDF wood /// table legs in massive oak wood

dimming

rotary dimmer switch at lamp head

dimension

light: height max. 140 cm / telescope 75–140 cm / head Ø 9 cm / stand Ø 23 cm
table: L38 x W38 x H40 cm

delivery

incl. lead transformer

| | | EUR | +19% |
|-------|---|----------|----------|
| RI-Y | | 1.007,56 | 1.199,00 |
| -K... | Kopf in P = poliert SM = schwarz matt SG = schwarz glanz WM = weiß matt WG = weiß glanz head in P = polished SM = black SG = black glossy WM = white WG = white glossy | | |

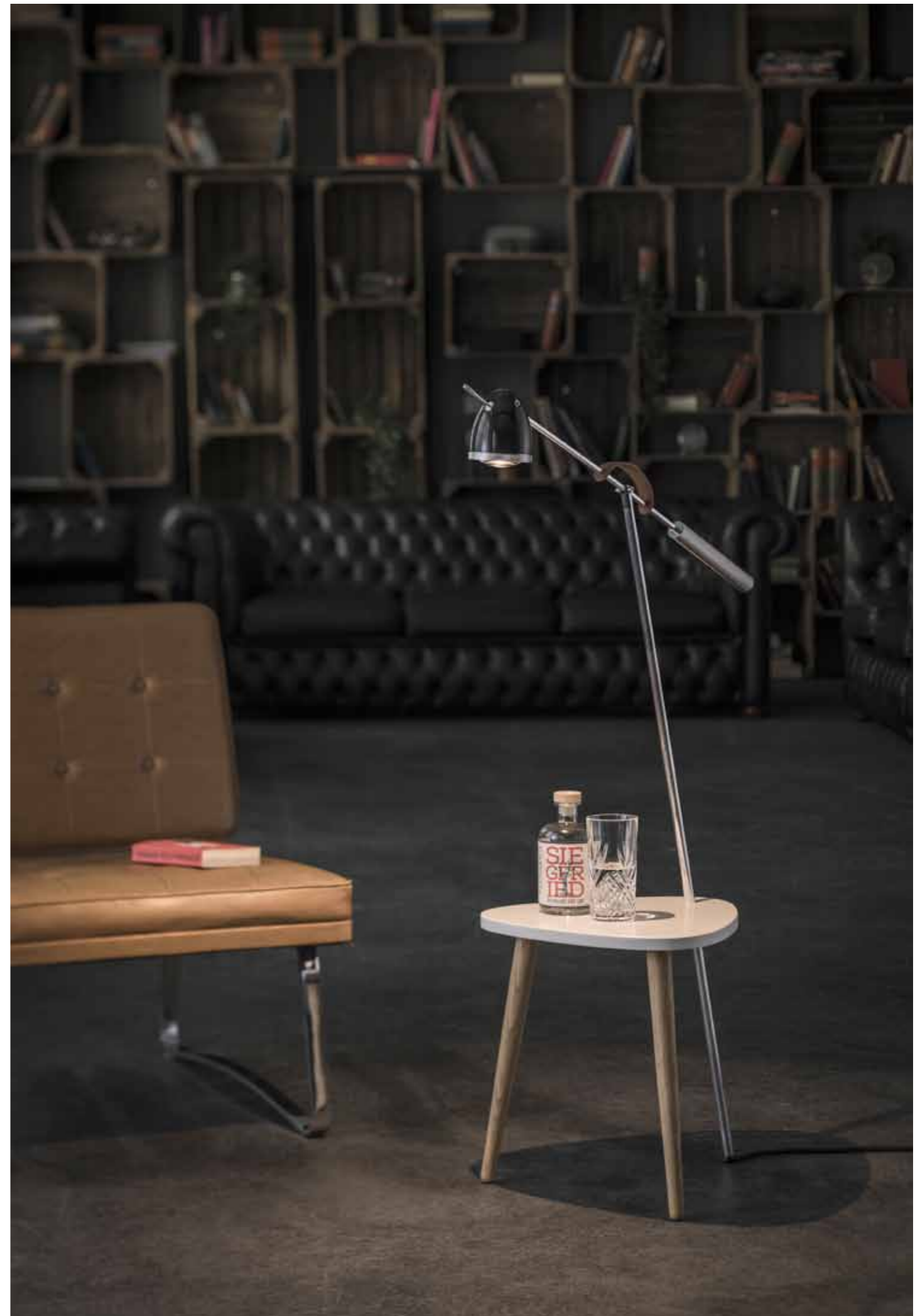

ERSATZTEILE SPARE PARTS

| ATHENE | | EUR | +19% |
|-------------------------------|--|-------|---------------|
| 590. LED-12V | LED Chip 12 V LED chip 12 V | 21,01 | 25,00 |
| 590. A-LED-12V | Leuchtkopf Einschub inkl. LED Chip 12 V lamp head insertion incl. LED chip 12 V | 42,02 | 50,00 |
| 590. TCI MICRO JOLLY | Netzteil, dimmbar über 1–10 V / PUSH transformer, dimmable by 1–10 V / PUSH | 42,02 | 50,00 |
| 590. TCI MICRO MD | Netzteil, phasendimmbar transformer, phase-cut dimmable | 42,02 | 50,00 |
| 590. TCI MINI JOLLY | Netzteil, dimmbar über 1–10 V / PUSH transformer, dimmable by 1–10 V / PUSH | 58,82 | 70,00 |
| 590. TCI MINI MD | Netzteil, phasendimmbar transformer, phase-cut dimmable | 42,02 | 50,00 |
| 590. TCI MINI DALI | Netzteil, dimmbar über DALI transformer, dimmable by DALI | 67,23 | 80,00 |
| 590. FW-020 | Flexwelle 20 cm (für AL1 / BDL1 / EL1 / MDL1) flexible shaft 20 cm (for AL1 / BDL1 / EL1 / MDL1) | 16,80 | 20,00 |
| 590. FW-050 | Flexwelle 50 cm (für AL2 / BDL2 / BWL2 / EL2 / MDL2) flexible shaft 50 cm (for AL2 / BDL2 / BWL2 / EL2 / MDL2) | 33,61 | 40,00 |
| 590. FW-050-GW | Flexwelle 50 cm (für ATL / KL / ML / WL / TL) flexible shaft 50 cm (for ATL / KL / ML / WL / TL) | 42,02 | 50,00 |
| 590. FW-100 | Flexwelle 100 cm (für 6DL) flexible shaft 100 cm (for 6DL) | 63,02 | 75,00 |
| 590. FW-150 | Flexwelle 150 cm (für 6SL) flexible shaft 150 cm (for 6SL) | 84,03 | 100,00 |
| 590. LIN-Ø50 | Glaslinse Ø 5 cm glass lense Ø 5 cm | 21,01 | 25,00 |
| 590. STN-24V | Steckernetzteil (für ATL / KL / ML / SL / TL / WL) plug transformer (for ATL / KL / ML / SL / TL / WL) | 42,02 | 50,00 |
| 590. STN-17W / 500MA | Steckernetzteil (für HWL / HSL) plug transformer (for HWL / HSL) | 50,42 | 60,00 |
| 590. STN-LI-ION-16.8V | Steckerladegerät Li-Ion (für alle Akkuleuchten) plug charger Li-ion (for all rechargeable lights) | 42,02 | 50,00 |
| 590. AKKU-LI-ION-14.8V | Li-Ion Akkupack (für alle Akkuleuchten) Li-ion battery rechargeable pack (for all rechargeable lights) | 63,02 | 75,00 |
| 590. TAST-M10 | Taster (für AL-S / BSL-S / BWL-S / EL-S / MDL-S) push button (for AL-S / BSL-S / BWL-S / EL-S / MDL-S) | 12,61 | 15,00 |

| ZEUS | | EUR | +19% |
|-----------------------------|--|-------|--------------|
| 590. LED-3V | LED Chip 3 V LED chip 3 V | 21,01 | 25,00 |
| 590. TCI MICRO JOLLY | Netzteil, dimmbar über 1–10 V / PUSH transformer, dimmable by 1–10 V / PUSH | 42,02 | 50,00 |
| 590. TCI MICRO MD | Netzteil, phasendimmbar transformer, phase-cut dimmable | 42,02 | 50,00 |
| 590. STN-24V | Steckernetzteil (für ATL / KL / ML / TL / WL) plug transformer (for ATL / KL / ML / TL / WL) | 42,02 | 50,00 |
| 590. FW-020 | Flexwelle 20 cm (für AL1 / BDL1 / EL1 / MDL1) flexible shaft 20 cm (for AL1 / BDL1 / EL1 / MDL1) | 16,80 | 20,00 |
| 590. FW-050 | Flexwelle 50 cm (für AL2 / BDL2 / BWL2 / EL2 / MDL2) flexible shaft 50 cm (for AL2 / BDL2 / BWL2 / EL2 / MDL2) | 33,61 | 40,00 |
| 590. FW-050-GW | Flexwelle 50 cm (für ATL / KL / ML / WL / TL) flexible shaft 50 cm (for ATL / KL / ML / WL / TL) | 42,02 | 50,00 |
| 590. LIN-Ø30 | Linse Ø 3 cm lense Ø 3 cm | 12,61 | 15,00 |
| 590. TAST-M10 | Taster (für AL-S / BSL-S / BWL-S / EL-S / MDL-S) push button (for AL-S / BSL-S / BWL-S / EL-S / MDL-S) | 12,61 | 15,00 |

| YLUX | | EUR | +19% |
|-------------------------------|--|-------|--------------|
| 590. LED-36V | LED Chip 36 V LED chip 36 V | 21,01 | 25,00 |
| 590. TCI MINI JOLLY | Netzteil, dimmbar über 1–10 V / PUSH transformer, dimmable by 1–10 V / PUSH | 58,82 | 70,00 |
| 590. TCI MINI MD | Netzteil, phasendimmbar transformer, phase-cut dimmable | 42,02 | 50,00 |
| 590. TCI MINI JOLLY HC | Netzteil, dimmbar über 1–10 V / PUSH (für 3SL) transformer, dimmable by 1–10 V / PUSH (for 3SL) | 67,23 | 80,00 |
| 590. LIN-Ø70 | Glaslinse Ø 7 cm glass lense Ø 7 cm | 21,01 | 25,00 |
| 590. STN-LI-ION-16.8V | Steckerladegerät Li-Ion (für alle Akkuleuchten) plug charger Li-ion (for all rechargeable lights) | 42,02 | 50,00 |
| 590. AKKU-LI-ION-14.8V | Li-Ion Akkupack (für alle Akkuleuchten) Li-ion battery rechargeable pack (for all rechargeable lights) | 63,02 | 75,00 |

| MIMIX | | EUR | +19% |
|---------------------------|---|-------|--------------|
| 590. LED-230V-4.5W | LED Chip 230 V LED chip 230 V | 12,61 | 15,00 |
| 590. SAVE-230V | Überspannungsschutzmodul (für alle 230 V Leuchten) power protection module (for all 230 V lights) | 8,40 | 10,00 |
| 590. LIN-Ø50 | Glaslinse Ø 5 cm glass lense Ø 5 cm | 21,01 | 25,00 |

VERSAND DELIVERY

| Inland inland (DE) | NETTO |
|--|-----------|
| Paketversand bis 300 Euro netto package delivery up to 300 Euro net | 9,50 |
| Paketversand über 300 Euro netto above 300 Euro net | frei free |
|  Speditionsversand forwarding agency | 35,00 |

| Ausland foreign (DK, SVN, IT, NL, AT, FR, LU, BE, PL, CZ) | NETTO |
|--|-----------|
| Paketversand bis 750 Euro netto package delivery up to 750 Euro net | 15,00 |
| Paketversand über 750 Euro netto above 750 Euro net | frei free |
|  Speditionsversand forwarding agency | 50,00 |

| Schweiz Switzerland (CH) | NETTO |
|--|-----------|
| Paketversand bis 1.500 Euro netto package delivery up to 1.500 Euro net | 35,00 |
| Paketversand über 1.500 Euro netto above 1.500 Euro net | frei free |
|  Speditionsversand forwarding agency | 50,00 |



* BESTSELLER

Im Rahmen des Schnelllieferprogramms bieten wir unsere Bestseller mit besonders kurzen Lieferzeiten an: die entsprechend markierten Artikel sind ohne Zusatzkosten innerhalb von 3 Werktagen versandfertig. Bitte beachten: Artikel aus dem Schnelllieferprogramm müssen immer SEPARAT bestellt werden! Vereinbarte Frachtfreigrenzen bzw. Versandkosten gelten auch im Schnelllieferprogramm.

As part of the fast delivery program, we offer our bestsellers with particularly short delivery times: the correspondingly marked items are ready to ship within 3 working days without additional costs. Please note: Articles from the fast delivery program must always be ordered SEPARATELY! Agreed freight rates and shipping costs are also valid in the quick delivery program.

IMPRESSUM IMPRINT

less'n'more® gmbh
Scheidweilerstr. 79
D-50933 Köln

T: +49 (0) 221 – 99 98 44 80
F: +49 (0) 221 – 99 98 44 88

info@less-n-more.com
www.less-n-more.com
www.next.design

Produktdesign product design
Dipl. Designer Kai Steffens

Fotografie photo
Nicole Hoppe
www.nicolehoppe.de

Preise gültig ab prices valid from
01.10.2019

Alle Rechte vorbehalten. Diese Preisliste oder Teile dieser dürfen nicht vervielfältigt, in Datenbanken gespeichert oder in irgendeiner Form übertragen werden ohne die schriftliche Genehmigung der less'n'more gmbh. Diese Preisliste wurde sorgfältig geprüft. Fehler können dennoch nicht ausgeschlossen werden. Für den Inhalt übernehmen wir keine Gewähr. Originalfarben können von den abgedruckten Farbmustern abweichen. Wir behalten uns vor, im Interesse der Produktverbesserung, Änderungen in Konstruktionsdetails, Oberflächen und Farben durchzuführen. Wir liefern ausschließlich auf Basis unserer allgemeinen Geschäftsbedingungen. Diese finden Sie auf unserer Internetseite unter www.less-n-more.com. Auf Wunsch senden wir Ihnen diese auch gerne zu. Alle Preise sind unverbindliche Preisempfehlungen.

All rights reserved. This pricelist or any excerpts thereof may not be duplicated, saved in databases or transmitted in any form whatsoever without explicit written authorisation from less'n'more gmbh. This pricelist has been checked with due care. Nevertheless it is possible for errors to occur. We shall not be held liable for the contents. Original colours may differ from the sample colours printed. We reserve the right to carry out modifications to design details, finishes and colours in the interests of product improvement. All of our deliveries to you are exclusively performed on the basis of our general terms and conditions. You can find them under www.less-n-more.com. All prices are not binding retail prices.



10 / 2019

www.less-n-more.com