

**AR
TECCHI
TU
RAL**

lighting systems
indoor | outdoor





martinelli luce



ARCHITECTURAL

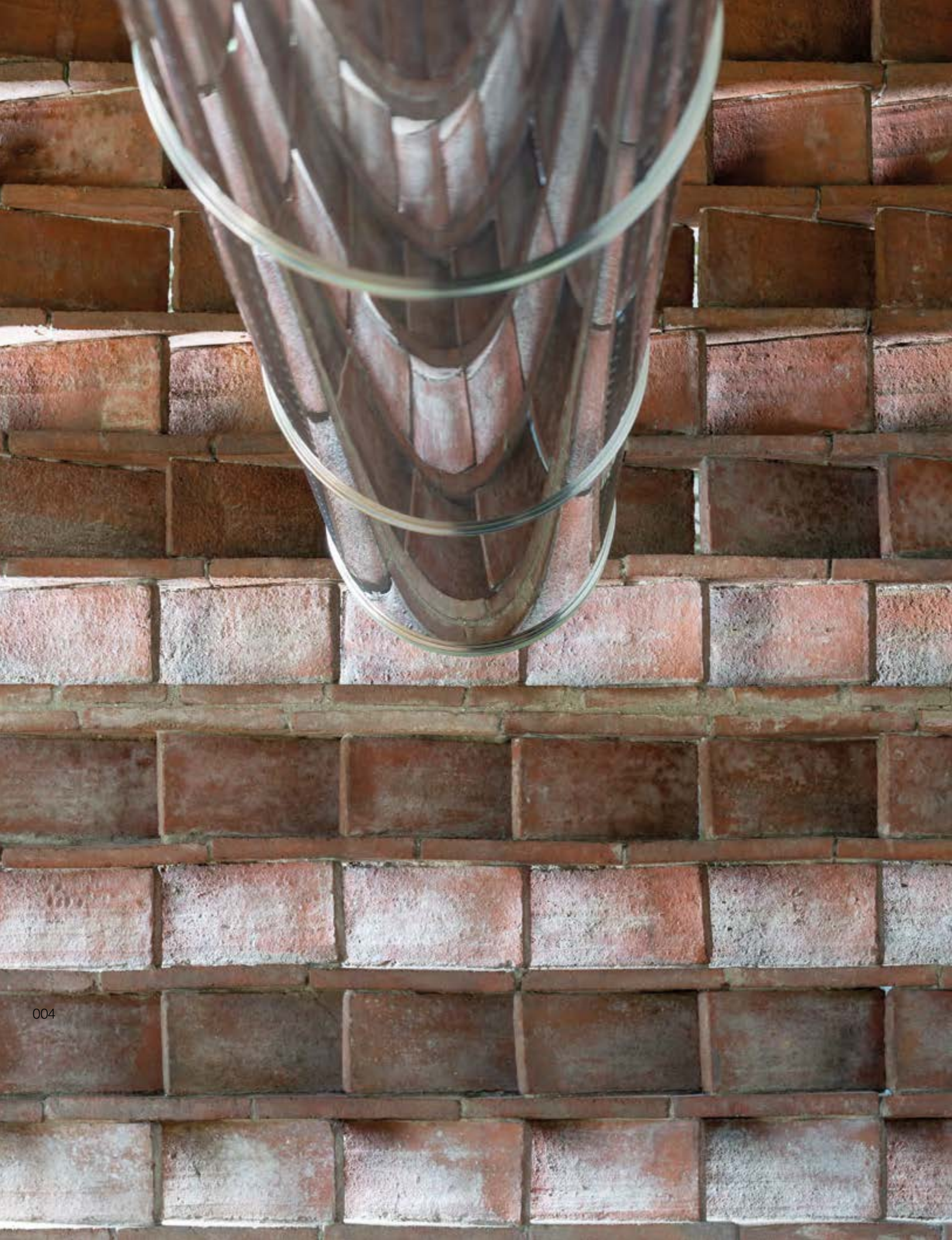

ARCHITECTURAL

Martinelli Luce è un'azienda conosciuta nel campo del design per la sua produzione di lampade, alcune diventate delle icone del design non solo italiano come Cobra, Pipistrello e Profiterolle, firmate rispettivamente da Elio Martinelli, Gae Aulenti, Sergio Asti. Molte altre lampade sono state disegnate dagli anni '60 ad oggi sia da altri noti architetti sia, le più recenti, da giovani designer che sono andate ad ampliare la collezione raccolta nel catalogo "Lampade" raccogliendo molte segnalazioni e premi, come il Compasso d'Oro con la lampada Elica di Brian Sironi.

In tutti questi anni hanno preso forma moltissime idee che hanno portato alla produzione non solo di lampade per interni, ma anche lampade per l'outdoor e ad una linea di prodotti a carattere tecnico, dedicati ad illuminare ampi spazi architettonici, ma anche oggetti o particolari da valorizzare con una luce d'accento. Lampade progettate appositamente per le nuove sorgenti a Led e studiate per soddisfare le esigenze di illuminazione professionali, tipiche dei luoghi di lavoro come uffici, show-room, centri commerciali, musei, apparecchi spesso nati per un determinato progetto, ma poi inseriti nel presente catalogo "Architectural" che raccoglie i prodotti più tecnici.

Con la nostra esperienza, la ricerca, lo studio e oggi con i mezzi digitali disponibili in Azienda, cerchiamo di dare risposte personalizzate alle esigenze dei progettisti. Lo staff tecnico risponderà alle varie richieste anche attraverso la customizzazione dei nostri prodotti di serie o, se necessario, fornirà il supporto per la progettazione e la realizzazione di rendering, prototipi, prodotti o pezzi speciali, costruiti con cura artigianale, ma sempre con qualità industriale.

Ogni problematica illuminotecnica rappresenta per noi uno stimolo ed una sfida da vincere.

Martinelli Luce is a company known in the design field for its production of lamps, some of which have become icons of not only Italian design such as Cobra, Pipistrello and Profiterolle, signed respectively by Elio Martinelli, Gae Aulenti, Sergio Asti. Many other lamps have been designed from the '60s to the present both by other well-known architects and, the most recent, by young designers who have expanded the assortment collected in the "Lamps" catalogue, collecting many honours and awards, such as the Compasso d'Oro with the Brian Sironi Elica lamp.

In all these years many ideas have taken shape that have led to the production not only of indoor lamps, but also outdoor lamps and a line of products with a more technical character, dedicated to illuminate large architectural spaces, but also objects or details to be enhanced with an accent light.

Lamps designed specifically for the new LED sources and designed to meet the needs of professional lighting, typical of workplaces such as offices, showrooms, shopping malls, museums, devices often created for a specific project, but then included in this "Architectural" catalogue that collects the most technical products.

With our experience, research, study and today with the digital means available in the Company, we try to give personalized answers to the needs of designers. Our technical staff will respond to the various requests also through the customization of our series products or, if necessary, will provide support for the design and implementation of renderings, prototypes, products or special pieces, built with craftsmanship, but always with industrial quality.

Every lighting problem represents a stimulus and a challenge for us to overcome.







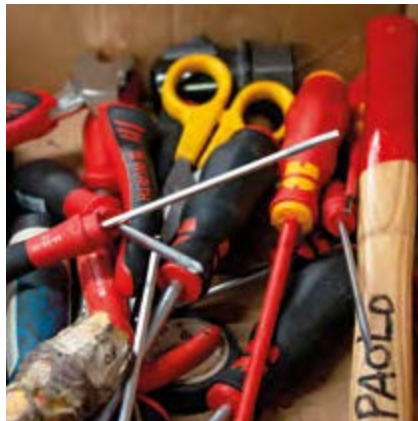





DATE	TIME	PERSON	TIME	PERSON	TIME
2024-07-26	14:00		14:00		14:00
2024-07-27	14:00		14:00		14:00
2024-07-28	14:00		14:00		14:00
2024-07-29	14:00		14:00		14:00
2024-07-30	14:00		14:00		14:00
2024-07-31	14:00		14:00		14:00

Scanned with CamScanner









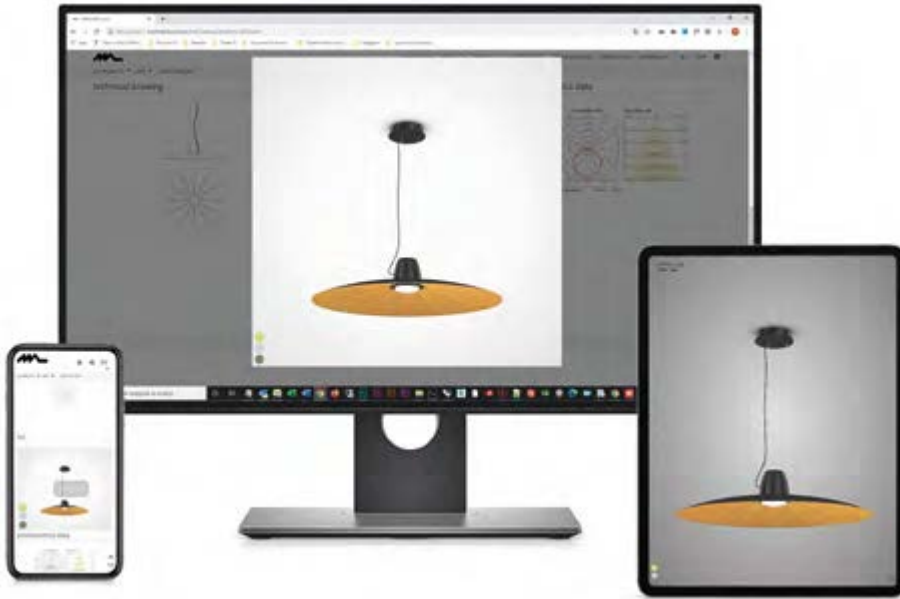

Servizi a supporto della progettazione illuminotecnica.
Digital services to support lighting design.

SayDuck

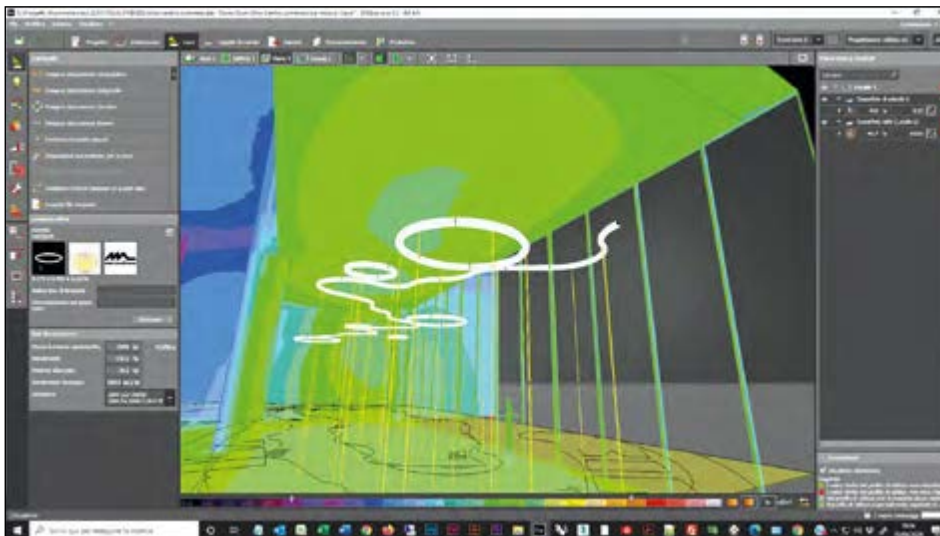

Dialux

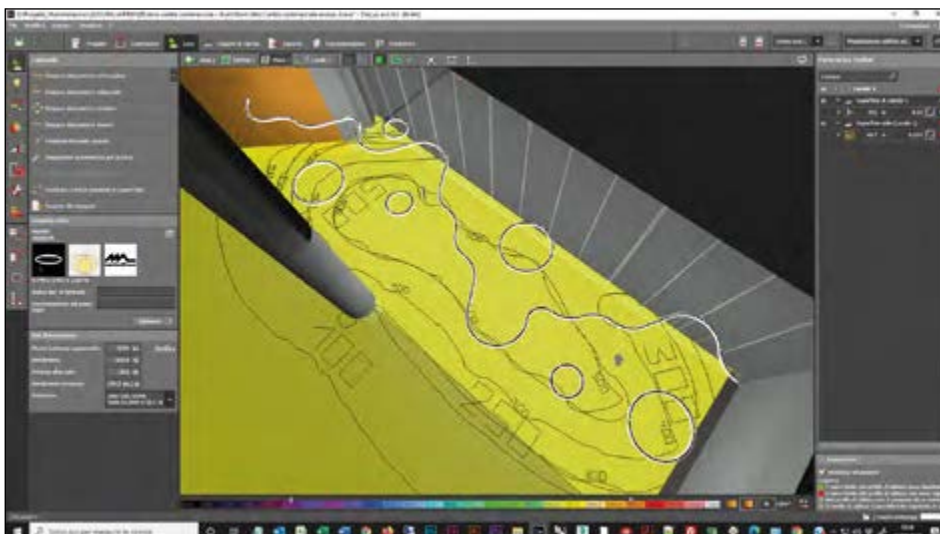

Martinelli Luce investe da anni nella tecnologia e in strumenti che possano rendere più facile la conoscenza dei propri prodotti e migliorare la risposta alle vostre necessità di illuminazione e di progettazione illuminotecnica, oggi anche attraverso le applicazioni di “realtà aumentata” e il 3D. Sul nostro sito www.martinelliluce.it, all'interno della scheda-prodotto, è possibile ruotare e zoomare l'apparecchio in modo da osservarlo da ogni angolazione, visualizzarlo in tutte le diverse possibili finiture e disporre delle relative dimensioni. Inoltre, potete scaricare i modelli 3D dei prodotti e utilizzarli nei vostri progetti di rendering o di progettazione. Attraverso la collaborazione con SayDuck, grazie alla realtà aumentata, è possibile contestualizzare, tramite la app scaricabile gratuitamente da Apple Store o Google Play, alcune delle nostre lampade all'interno degli spazi abitativi da voi progettati. Martinelli Luce inoltre, da diversi anni, è partner di Dial, un'azienda leader nella realizzazione di strumenti e software professionali (linea Dialux) utilizzati da architetti e progettisti di tutto il mondo per il calcolo, la progettazione e la visualizzazione illuminotecnica. Tramite il plug-in Dial scaricabile dal nostro sito è possibile, all'interno del programma Dialux, utilizzare i modelli 3D delle lampade presenti nel nostro catalogo, corredati da curva fotometrica, per realizzare calcoli illuminotecnici e rendering. I risultati possono essere trasferiti in programmi CAD tipo Revit, AutoCad, ArchiCAD, etc. Martinelli Luce metterà inoltre a disposizione degli utenti, un configuratore di prodotto che, in base allo specifico progetto, permetterà di creare una serie di famiglie di prodotto componibili in maniera semplice e grafica. La facilità d'uso del sistema renderà divertente crearsi il proprio prodotto in base alle personali esigenze di colore, dimensioni, forma, temperatura di colore e caratteristiche del fascio della sorgente luminosa, dimmerazione, così da ottenere alla fine della configurazione un documento pdf con tutti i dettagli del proprio progetto realizzato. Per gli utenti registrati il documento verrà corredato anche dei prezzi di listino e di ulteriori caratteristiche di dettaglio dei prodotti utilizzati.

Martinelli Luce has been investing for years in technology and tools that allow to better understand its products and improve the response to your lighting and design needs, today also through “augmented reality” and 3D images. On our website www.martinelliluce.it, inside the product technical datasheet, it is possible to rotate and zoom the device in order to observe it from every angle, visualize it in all the different possible finishes and extract its dimensions. In addition, you can download 3D models of the products and use them in your rendering or design projects. Thanks to augmented reality and our collaboration with SayDuck, it is possible to contextualize some of our lamps inside the living spaces you designed, through the free app available on the Apple Store or Google Play. Since many years Martinelli Luce is also a partner of Dial, a leading company in the creation of professional tools and software (Dialux line) used by architects and designers all over the world for lighting computations, designing and visualization. The Dial plug-in, available on our website let you use, within the Dialux program, the 3D models of all lamps in our catalogue, together with photometric curve, to perform lighting calculations and renderings. The results can be transferred into CAD programs such as Revit, AutoCad, ArchiCAD, etc. Martinelli Luce will also provide users with a configurator that, according to the specific project, will allow to create various families of modular products in a simple and graphical way. With this user-friendly system you will enjoy creating your own product according to your personal needs such as color, size, shape, dimming, color temperature and beam characteristics of the light source, in order to obtain at the end of the configuration a PDF document with all the details of your project. For registered users, the document will also include the price-list and additional details of the products used.

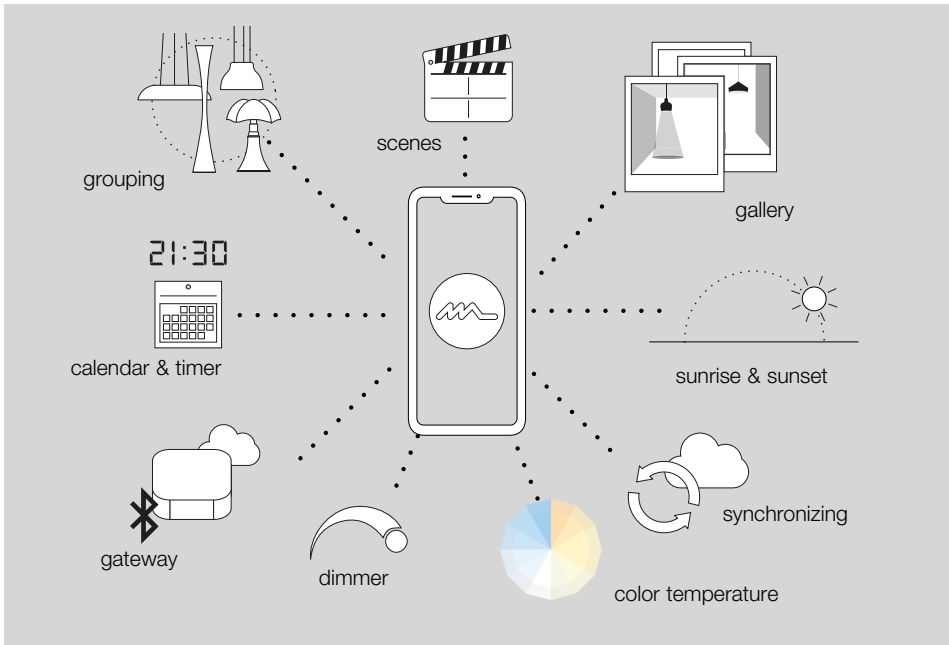

LIGHT YOU LIKE

“Light you like” è un progetto di Martinelli Luce che attraverso la tecnologia “Bluetooth” ti rende protagonista nello spazio del vivere quotidiano per dare vita a una nuova esperienza sensoriale e migliorare il tuo benessere.

Con questa innovazione tecnologica Martinelli Luce offre una luce modulabile grazie al sistema di controllo dell'intensità e per alcuni prodotti della temperatura del colore che ti permette di personalizzare lo spazio abitativo in base alle tue emozioni e sensazioni. Intervenire sull'illuminazione della tua abitazione diventa facile ed intuitivo, grazie all'utilizzo di app compatibili con i sistemi Apple e Android, le quali attraverso semplici controlli touch su smartphone e tablet permettono di regolare più dispositivi illuminanti e di adattare la luce alle tue esigenze.

Le lampade che utilizzano tale tecnologia sono evidenziati con il logo

LIGHT YOU LIKE

Con le app è possibile:



- Dimmerare le lampade tramite dispositivo bluetooth, iOS e Android Apps
- Regolare la temperatura della luce in maniera dinamica da 2500 a 6700K (per alcuni prodotti compatibili)
- Creare gruppi di lampade per la sincronizzazione (max 127)
- Creare scene: per accensioni temporali; per accensione/spegnimento gruppi di lampade
- Scattare una foto alla lampada e vederla nell'app per semplificare la selezione del prodotto.

“Light you like” is Martinelli Luce’s project which, through “Bluetooth” technology, makes you the protagonist in the space of your daily life to give life to a new sensorial experience and improve your well-being.

With this technological innovation, Martinelli Luce offers a modular light thanks to the system of control of the intensity and color temperature allowing you to customize your living space according to your emotions and sensations.

Working on the lighting of your home becomes easy and intuitive, thanks to the use of apps compatible with Apple and Android systems, which through simple touch controls on smartphones and tablets allow you to adjust multiple lighting devices and adapt the light to your needs .

The lamps that use this technology are highlighted with the logo

LIGHT YOU LIKE

With the apps you can:

- Dim the lamps via bluetooth device, iOS and Android Apps
- Adjust the light temperature dynamically from 2500 to 6700K (for some compatible products)
- Create groups of lamps for synchronization (max 127)
- Create scenes: for temporal lighting; for switching groups of lamps on/off
- Take a photo of the lamp and view it in the app to simplify product selection.

DESIGNERS

Elio Martinelli
Massimo Farinatti
Studio Lucchi & Biserni

Emiliana Martinelli
PLS design - Lorenzo Perini
Angelo Micheli

Yonoh Creative Studio
Andrea Menchini
Studio Foa



Paola Navone
Karim Rashid
Atelier(s) Alfonso Femia

Marc Sadler
Serge & Robert Cornelissen
Marco Pisati

Peluffo&Partners
Studio Natural



PREMI E RICONOSCIMENTI / AWARDS AND ACKNOLEGMENTS



2009
2011
2013



2003
2010
2011
2015
2020
2021
2022
2023



2011
2013
2014
2015
2016
2017
2018
2019
2020
2021
2022
2023



2010



2011

reddot design award



2011



1979
2015



2016
2020
2021



2012
2014

NOMINEE



INDICE / INDEX

INDOOR 31

OUTDOOR 389



INDICE ALFABETICO PER FAMIGLIE / ALPHABETICAL INDEX BY PRODUCT FAMILY

INDOOR

BINARI / TRACK

P. 322

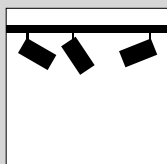

BRICK

P. 370

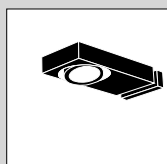

CALABRONE

P. 210

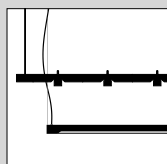

CALABRONET

P. 228

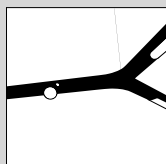

CIP

P. 284

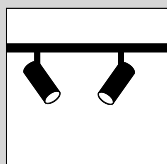

CIRCULAR POL

P. 108

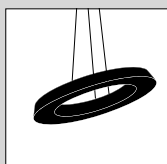

CIRCULAR POL XXL

P. 118



CIRCULAR SLIM

P. 084

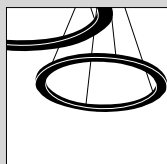

COLIBRÌ

P. 166

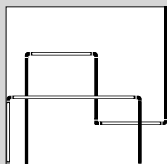

CONDOR

P. 342

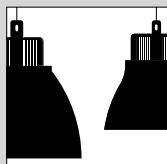

CORONA

P. 360

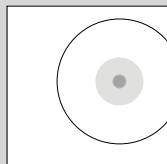

2003

P. 336

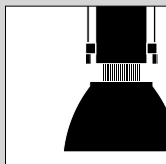

EYE

P. 378

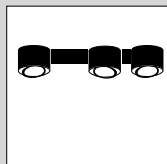

GRILLO

P. 298

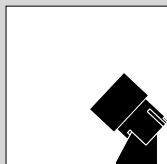

HUSH

P. 146

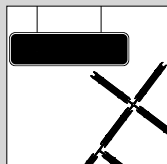

KOKO UNO

P. 260

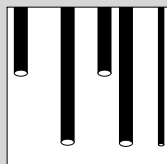

LENT

P. 138

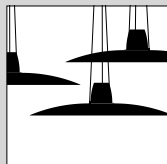

LOOP

P. 032

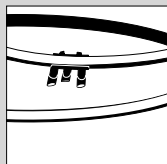

LUNA

P. 088

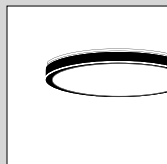

LUNAOP

P. 050

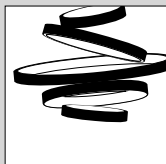

MAMBA

P. 092

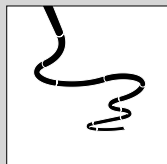

NUVOLE Vagabonde

P. 348

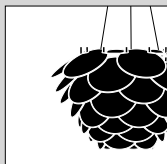

OLYMPIC

P. 364

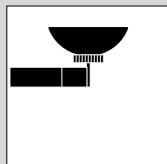

PISTILLO

P. 132

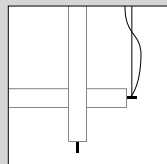

R11

P. 306

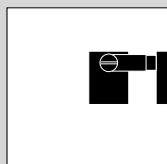

R19

P. 316

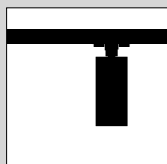

R23

P. 294

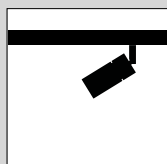

S23

P. 290

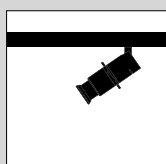

SHANGHAI

P. 246

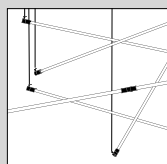

SISTEMA U

P. 268

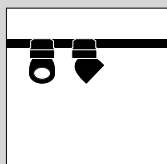

SOUND

P. 354

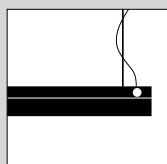





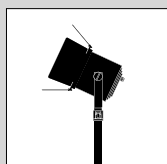







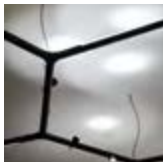



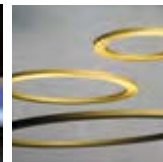
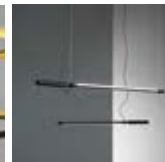





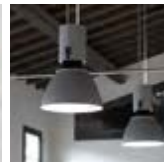

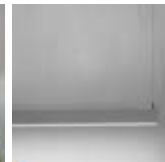

SPOTTÒ

P. 332

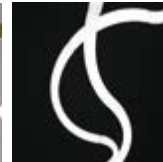
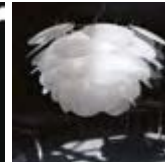

INDOOR

















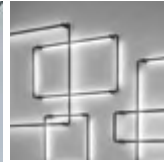

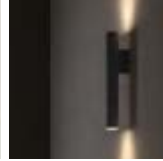

SOSPENSIONI / SUSPENSIONS

<p>CALABRONE A P. 218</p> 	<p>CALABRONE S P. 214</p> 	<p>CALABRONET P. 236</p> 	<p>CALABRONET TRIS P. 244</p> 	<p>CIRCULAR POL P. 114</p> 	<p>CIRCULAR POL XXL P. 128</p> 	<p>CIRCULAR SLIM P. 086</p> 	<p>COLIBRÌ AT P. 184</p> 
<p>COLIBRÌ C P. 198</p> 	<p>COLIBRÌ M P. 180</p> 	<p>COLIBRÌ Q P. 170</p> 	<p>COLIBRÌ S P. 190</p> 	<p>CONDOR P. 342</p> 	<p>2003 P. 340</p> 	<p>HUSH P. 154</p> 	<p>HUSH P. 162</p> 
<p>KOKO UNO P. 262</p> 	<p>LENT P. 144</p> 	<p>LOOP circular P. 040</p> 	<p>LOOP square P. 044</p> 	<p>LUNAOP P. 058</p> 	<p>LUNAOP SLIM P. 072</p> 	<p>MAMBA P. 102</p> 	<p>NUVOLE Vagabonde P. 352</p> 
<p>PISTILLO P. 136</p> 	<p>SHANGHAI P. 252</p> 	<p>SHANGHAI P. 258</p> 	<p>SISTEMA U P. 282</p> 	<p>SOUND P. 358</p> 			

INDICE ALFABETICO PER TIPOLOGIA / ALPHABETICAL INDEX BY PRODUCT TYPE

INDOOR

PARETE-SOFFITTO / WALL-CEILING

BRICK P. 374	CALABRONE S P. 226	CIRCULAR POL P. 116	COLIBRÌ AT P. 186	COLIBRÌ D P. 194	COLIBRÌ M P. 180	COLIBRÌ Q P. 174	COLIBRÌ S P. 196
							
CORONA P. 360	EYE P. 384	GRILLO P. 304	HUSH P. 158	HUSH P. 164	KOKO UNO P. 264	LUNA P. 090	LUNAOP P. 066
							
MAMBA P. 102	OLYMPIC P. 368	R11 P. 312	SHANGHAI P. 254	SISTEMA U P. 276			
							

INDICE ALFABETICO PER TIPOLOGIA / ALPHABETICAL INDEX BY PRODUCT TYPE

INDOOR

TERRA / FLOOR

BRICK

P. 376



CALABRONE S

P. 222

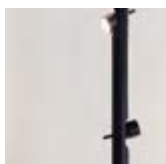

COLIBRÌ AT

P. 204

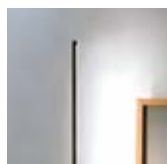

COLIBRÌ C

P. 200



COLIBRÌ S

P. 202



COLIBRÌ TRIPODE

P. 206

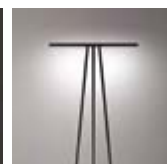

SPOTTÒ

P. 334

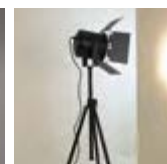

FARETTI PER BINARIO ELETTRIFICATO / SPOTLIGHTS FOR ELECTRIFIED TRACK

CIP

P. 288



GRILLO

P. 304



MODULI

P. 330



R19

P. 320

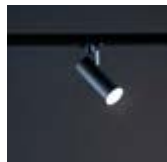

R23

P. 296

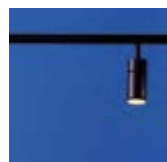

S23

P. 292

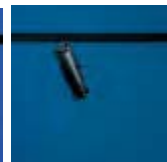

SISTEMA U

P. 272

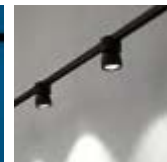

028

INCASSI / RECESSED

EYE

P. 386



TAVOLO / TABLE

COLIBRÌ TAVOLO

P. 208



OUTDOOR

AMANITA
P. 398

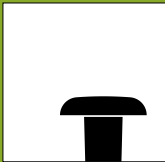

BICONICA POL
P. 504



BOLETO
P. 432

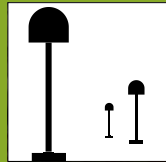

BOWL
P. 518

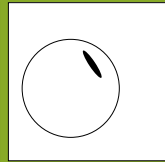

BRUCO
P. 420

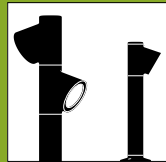

CIULIFRULI
P. 478

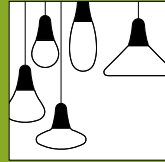

CYBORG
P. 438



CYBORG BIG
P. 444



FROG
P. 404

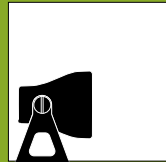

GLOUGLOU POL
P. 512

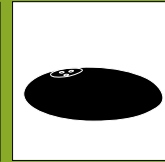

KIKI
P. 466

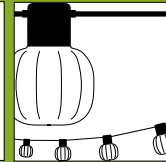

KOALA
P. 462

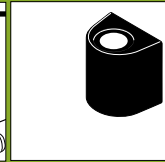

LADY GALALA
P. 390

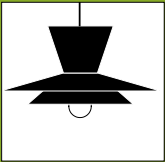

PISTILLO
P. 494

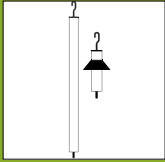

POLO
P. 456

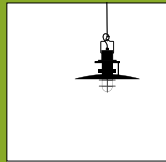

PONT
P. 496



TRILLY
P. 486

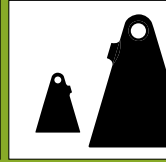



indoor

LOOP
LUNAOP
LUNAOP SLIM
CIRCULAR SLIM
LUNA
MAMBA
CIRCULAR POL
CIRCULAR POL XXL
PISTILLO
LENT
HUSH
COLIBRÌ
CALABRONE
CALABRONET
CALABRONET TRIS
SHANGHAI
KOKO UNO
SISTEMA U
CIP
S23
R23
GRILLO
R11
R19
BINARI
SPOTTÒ
2003
CONDOR
NUVOLE VAGABONDE
SOUND
CORONA
OLYMPIC
BRICK
EYE

LOOP

Un sottile profilo in estruso di alluminio calandrato definisce anelli di grandi e vari diametri e forme quadrangolari. Un sistema a luce diffusa e tecnologica per illuminare grandi ambienti che richiedono un'alta efficienza luminosa con una presenza leggera.

A slim structure in extruded calendered aluminium to define big rings having different diameters and quadrangular shapes. A system with diffused and technological light for large environments that require high luminous efficiency through a lightweight object.

Emiliana Martinelli



LOOP



034







LOOP



Villa privata, Vienna, Austria - architetto Ralf Bovelet





Hotel TRS, Yucatán, Messico

LOOP

circolare / circular



Apparecchio a sospensione a emissione di luce interna diffusa. Composto da settori curvi in profilato di alluminio estruso verniciato, che uniti tra loro con giunti formano anelli di diverso diametro, sospesi con cavi in acciaio. Diffusore in policarbonato opal bianco.

Sorgente di luce LED integrata.

Alimentatori elettronici dimmerabili inseriti all'interno del rosone da fissare al soffitto o nel controsoffitto.

Disponibile a richiesta 2700K e 4000K.

Suspension lamp, with diffused inner light emission, composed with curved modules in painted extruded aluminium sectors.

The union of these sectors with joints, offers different diameters rings, hanged by stainless steel cables.

White opal polycarbonate diffuser.

Integrated LED light source.

Electronic dimmable driver inside the ceiling rose or inside the false ceiling.

Available on request 2700K and 4000K.



watt	flusso/flux	CCT	Kg	colore/colour	codice/code
------	-------------	-----	----	---------------	-------------

LOOP Ø160

173W 230V	17000lm	3000K	16	<input type="radio"/> bianco/white <input type="radio"/> nero/black <input type="radio"/> oro p./p. gold <input type="radio"/> rame/copper	21003/160/DIM/BI 21003/160/DIM/NE 21003/160/DIM/AU 21003/160/DIM/CU
-----------	---------	-------	----	---	--

rosone al soffitto / ceiling rose Ø28 H6
 alimentatori elettronici dimmerabili / electronic dimmable drivers

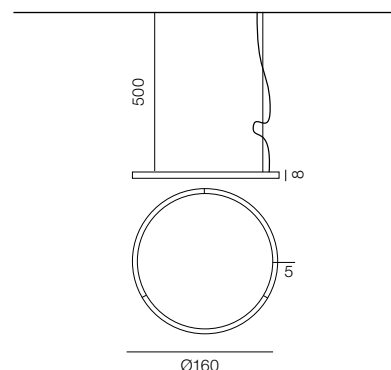
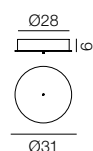
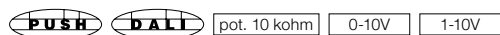

LOOP Ø200

216W 230V	21000lm	3000K	20	<input type="radio"/> bianco/white <input type="radio"/> nero/black <input type="radio"/> oro p./p. gold <input type="radio"/> rame/copper	21003/200/DIM/BI 21003/200/DIM/NE 21003/200/DIM/AU 21003/200/DIM/CU
-----------	---------	-------	----	---	--

rosone al soffitto / ceiling rose Ø28 H6
 alimentatori elettronici dimmerabili / electronic dimmable drivers

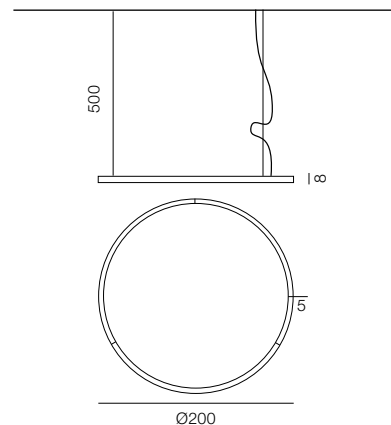
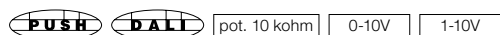

LOOP Ø300

325W 230V	31600lm	3000K	32	<input type="radio"/> bianco/white <input type="radio"/> nero/black <input type="radio"/> oro p./p. gold <input type="radio"/> rame/copper	21003/300/DIM/BI 21003/300/DIM/NE 21003/300/DIM/AU 21003/300/DIM/CU
-----------	---------	-------	----	---	--

rosone al soffitto / ceiling rose 2xØ28 H6
 alimentatori elettronici dimmerabili / electronic dimmable drivers

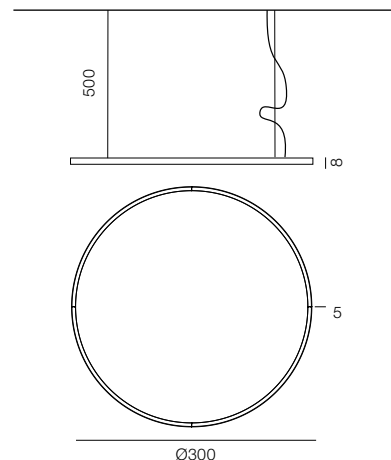
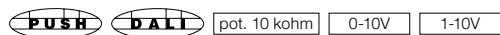



Ø160

21003/160/DIM/BI LOOP

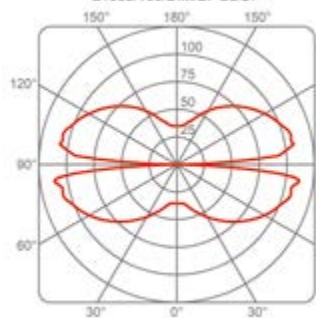

I_{max} 108 cd/klm

α 56°

β 127°

LOOP

circolare / circular



Apparecchio a sospensione a emissione di luce interna diffusa. Composto da settori curvi in profilato di alluminio estruso verniciato, che uniti tra loro con giunti formano anelli di diverso diametro, sospesi con cavi in acciaio. Diffusore in policarbonato opal bianco.

Sorgente di luce LED integrata.

Alimentatori elettronici dimmerabili inseriti all'interno del rosone da fissare al soffitto o nel controsoffitto.

Disponibile a richiesta 2700K e 4000K.

Suspension lamp, with diffused inner light emission, composed with curved modules in painted extruded aluminium sectors.

The union of these sectors with joints, offers different diameters rings, hanged by stainless steel cables.

White opal polycarbonate diffuser.

Integrated LED light source.

Electronic dimmable driver inside the ceiling rose or inside the false ceiling.

Available on request 2700K and 4000K.



watt	flusso/flux	CCT	Kg	colore/colour	codice/code
------	-------------	-----	----	---------------	-------------

LOOP Ø400

433W 230V	42100lm	3000K	40	○ bianco/white	21003/400/DIM/BI
				● nero/black	21003/400/DIM/NE
				● oro p./p. gold	21003/400/DIM/AU
				● rame/copper	21003/400/DIM/CU

rosone al soffitto / ceiling rose Ø28 H6

alimentatori elettronici dimmerabili / electronic dimmable drivers

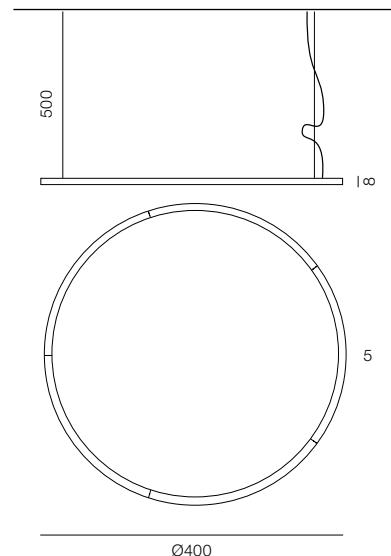
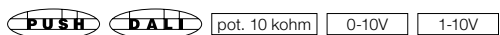

LOOP Ø500

540W 230V	52504lm	3000K	45	○ bianco/white	21003/500/DIM/BI
				● nero/black	21003/500/DIM/NE
				● oro p./p. gold	21003/500/DIM/AU
				● rame/copper	21003/500/DIM/CU

rosone al soffitto / ceiling rose 2xØ28 H6

alimentatori elettronici dimmerabili / electronic dimmable drivers

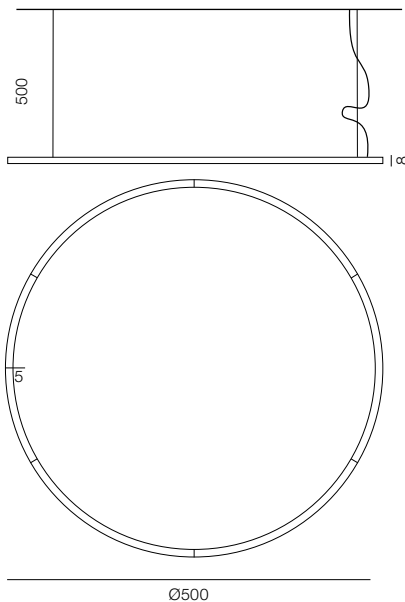
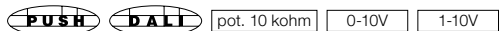



LOOP

quadrata / square

Apparecchio a sospensione a emissione di luce interna diffusa. Formato da profili lineari e curvi uniti con giunti, in alluminio verniciato. Sorgente di luce LED integrata. Alimentatori elettronici dimmerabili inseriti all'interno del rosone da fissare al soffitto o nel controsoffitto. Disponibile a richiesta a 2700K e 4000K.

Suspension lamp, with diffused inner light emission. Composed by linear and curved profiles connected with joints, in painted aluminium. Integrated LED light source. Electronic dimmable drivers inside the false ceiling or inside the ceiling rose. Available on request 2700K and 4000K.



watt	flusso/flux	CCT	Kg	colore/colour	codice/code
------	-------------	-----	----	---------------	-------------

LOOP 170x170

207W 230V	20100lm	3000K	18,5	<input type="radio"/> bianco/white <input type="radio"/> nero/black <input type="radio"/> oro p./p. gold <input type="radio"/> rame/copper	21006/170/DIM/BI 21006/170/DIM/NE 21006/170/DIM/AU 21006/170/DIM/CU
-----------	---------	-------	------	---	--

rosone al soffitto / ceiling rose Ø28 H 6
 alimentatori elettronici dimmerabili / electronic dimmable drivers

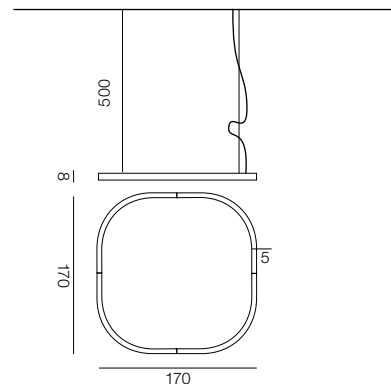
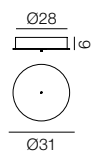
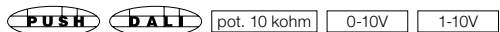

LOOP 250x250

329W 230V	32000lm	3000K	28	<input type="radio"/> bianco/white <input type="radio"/> nero/black <input type="radio"/> oro p./p. gold <input type="radio"/> rame/copper	21006/250/DIM/BI 21006/250/DIM/NE 21006/250/DIM/AU 21006/250/DIM/CU
-----------	---------	-------	----	---	--

rosone al soffitto / ceiling rose 2xØ28 H 6
 alimentatori elettronici dimmerabili / electronic dimmable drivers

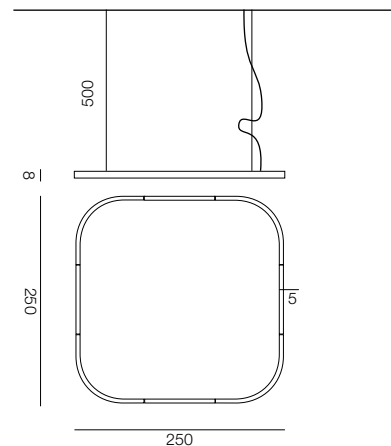
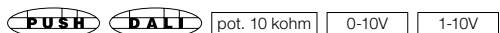

LOOP RETTANGOLARE / RECTANGULAR 170x370

374W 230V	36600lm	3000K	32	<input type="radio"/> bianco/white <input type="radio"/> nero/black <input type="radio"/> oro p./p. gold <input type="radio"/> rame/copper	21010/DIM/BI 21010/DIM/NE 21010/DIM/AU 21010/DIM/CU
-----------	---------	-------	----	---	--

rosone al soffitto / ceiling rose 2xØ28 H 6
 alimentatori elettronici dimmerabili / electronic dimmable drivers

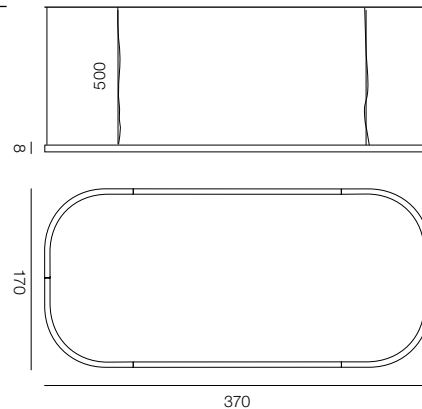
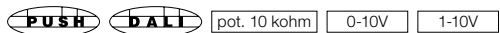

044

a richiesta è possibile realizzare altre configurazioni / other configurations can be made on request



170x170

21006/170/DIM/BI LOOP

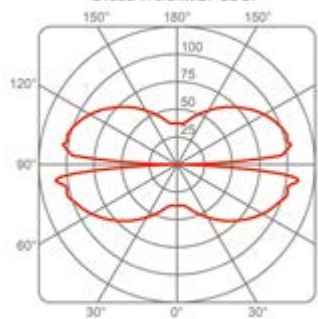

I_{max} 109 cd/klm

α 57°

β 128°

LOOP

MATI Art Gallery – Santorini, Grecia – MB studio luce Mariangela Brignani



LOOP

faretti / spot



Il sistema si è ampliato di un faretto singolo e di un kit con tre faretti orientabili da posizionare tramite un supporto con pomello di fissaggio alla lampada Loop nelle sue versioni. Sorgente di luce a LED integrata. Alimentatore da inserire all'interno del rosone al soffitto o remoto.

This system has been improved by adding a single spotlight or a kit of three adjustable spots to be fixed through a mounting knob support, to the inner light version of the Loop system. Integrated LED light source. With driver to be placed inside the ceiling rose or remotely.



watt	beam	flusso/flux	CCT	Kg	colore/colour	codice/code
------	------	-------------	-----	----	---------------	-------------

KIT 1 FARETTO / KIT 1 SPOTLIGHTS

12,2W 48V	narrow	1170lm	3000K	0,5	○ bianco/white	40088/BI
					● nero/black	40088/NE
					● oro perlato/golden	40088/AU
					● rame/copper	40088/CU

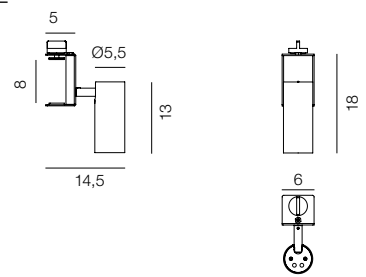

KIT 3 FARETTI / KIT 3 SPOTLIGHTS per Loop / for Loop Ø160 - Ø200

3x12,2W 48V narrow	3x1170lm	3000K	1,8	○ bianco/white	40091/BI
				● nero/black	40091/NE
				● oro p./p. gold	40091/AU
				● rame/copper	40091/CU

su richiesta fascio medium o wide / medium or wide beam on request

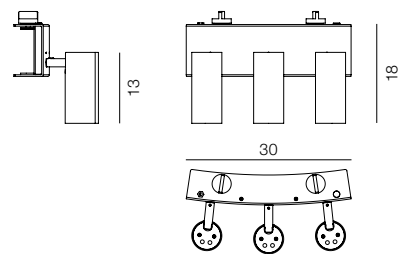

KIT 3 FARETTI / KIT 3 SPOTLIGHTS per Loop / for Loop Ø300

3x12,2W 48V narrow	3x1170lm	3000K	1,8	○ bianco/white	40093/BI
				● nero/black	40093/NE
				● oro p./p. gold	40093/AU
				● rame/copper	40093/CU

su richiesta fascio medium o wide / medium or wide beam on request

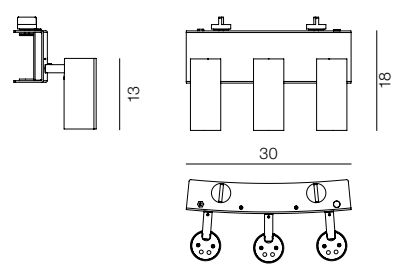



watt	Kg	colore/colour	codice/code
------	----	---------------	-------------

ALIMENTATORE REMOTO max 5 faretti / REMOTE DRIVER up to 5 spots

60W - 230V	0,4		40096
------------	-----	--	-------

ROSONE A SOFFITTO / CEILING ROSE

con alimentatore per 2 linee di max 2x4 faretti / with driver for 2 lines up to 2x4 spots (max 16 spots)

2x100W - 230V/48V	1,4	○ bianco/white	40097/BI
2x100W - 230V/48V	1,4	● nero/black	40097/NE
2x100W - 230V/48V	1,4	● oro p./p. gold	40097/AU
2x100W - 230V/48V	1,4	● rame/copper	40097/CU

ACCESSORIO ANTIABBAGLIAMENTO / ANTI-GLARE ACCESSORY



○ bianco/white	40128/BI
● nero/black	40128/NE
● oro p./p. gold	40128/AU
● rame/copper	40128/CU

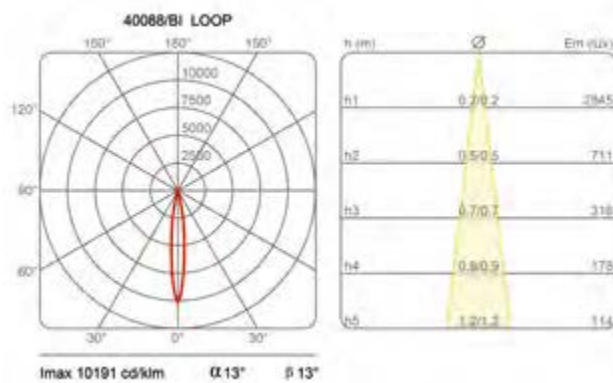
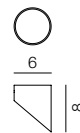

LUNAOP

LIGHTYOU LIKE

Un segno grafico illumina lo spazio.
Una sospensione con sorgente
luminosa a Led, caratterizzata da un
minimo impatto visivo.
Progettato per garantire un alto
rendimento luminoso, in tre diversi
diametri, componibili, adatto per
illuminare sia ambienti pubblici che
ambienti domestici.

A graphic sign illuminates the space. A
suspension lamp with LED light source,
characterized by a minimal visual
impact.

Designed to guarantee high luminous
efficiency, it comes in three different
modular diameters, and is ideal to
illuminate both public and domestic
environments.

Emiliana Martinelli







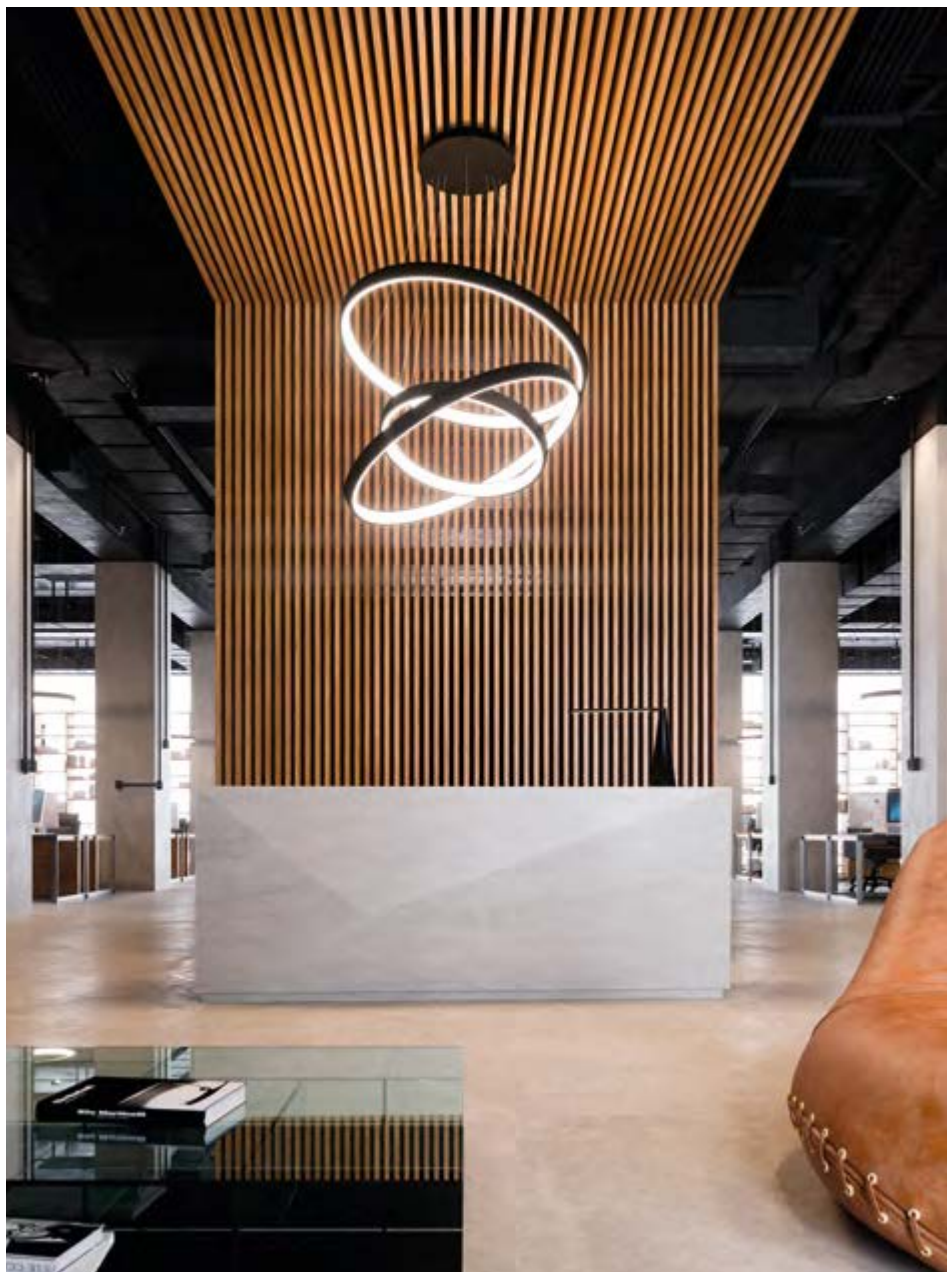







Farmacia comunale 3, Camaiore, Lucca – arch. Simone Bruni

LUNAOP

sospensione / suspension

Lampada a sospensione a luce diffusa.
 Struttura in alluminio verniciato nei colori bianco, nero, oro perlato o rame.
 Diffusore in metacrilato opal bianco.
 Disponibile in tre diametri (120, 80, 50) sospesa con i cavi di alimentazione da collegare ad un rosone da fissare al soffitto sia per la versione singola, sia per la versione composta (da 2 fino a 6 Lunaop).
 Sorgente di luce a LED integrata a 2700K, 3000K o 4000K.
 Alimentatore elettronico integrato nel rosone.

Suspension lamp with diffused light.
 White, black, pearly gold or copper aluminium structure.
 White opal methacrylate diffuser.
 Three diameters (120, 80, 50), suspended with power cables to be connected to a ceiling rose and mounted on the ceiling for both single and multiple versions (consisting of 2 to 6 Lunaop rings).
 Integrated LED light source (2700K, 3000K or 4000K).
 Electronic driver integrated in the ceiling rose.



watt	flusso/flux	CCT	Kg	colore/colour	codice/code
LUNAOP Ø50					
48W 24V	3700lm	2700K	2	○ bianco/white	40001/2700/BI
				● nero/black	40001/2700/NE
				● oro perlato/pearl gold	40001/2700/AU
				● rame/copper	40001/2700/CU
				● bronzo materico/rough bronze	40001/2700/BM
				● ottone vintage/vintage brass	40001/2700/OV
		3000K	○ bianco/white	40001/3000/BI	
				● nero/black	40001/3000/NE
				● oro perlato/pearl gold	40001/3000/AU
				● rame/copper	40001/3000/CU
				● bronzo materico/rough bronze	40001/3000/BM
				● ottone vintage/vintage brass	40001/3000/OV
		4000K	○ bianco/white	40001/4000/BI	
				● nero/black	40001/4000/NE
				● oro perlato/pearl gold	40001/4000/AU
				● rame/copper	40001/4000/CU
				● bronzo materico/rough bronze	40001/4000/BM
				● ottone vintage/vintage brass	40001/3000/OV

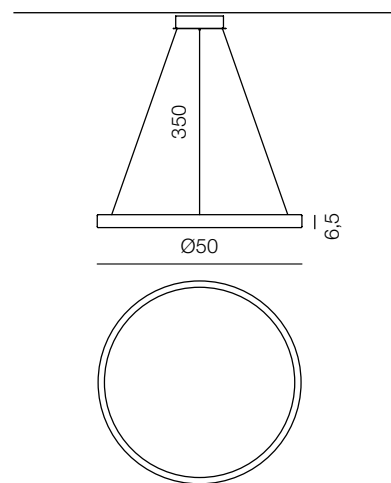

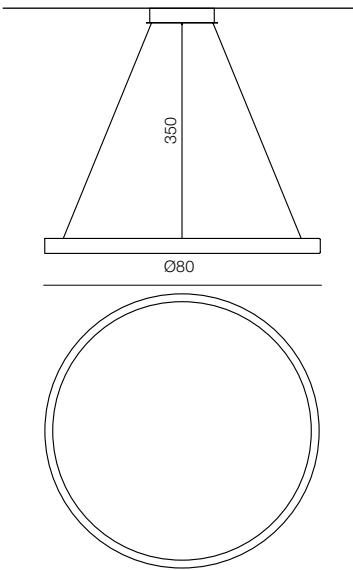

watt	flusso/flux	CCT	Kg	colore/colour	codice/code
LUNAOP Ø80					
72W 24V	5600lm	2700K	3	○ bianco/white	40002/2700/BI
				● nero/black	40002/2700/NE
				● oro perlato/pearl gold	40002/2700/AU
				● rame/copper	40002/2700/CU
				● bronzo materico/rough bronze	40002/2700/BM
				● ottone vintage/vintage brass	40002/2700/OV
		3000K		○ bianco/white	40002/3000/BI
				● nero/black	40002/3000/NE
				● oro perlato/pearl gold	40002/3000/AU
				● rame/copper	40002/3000/CU
				● bronzo materico/rough bronze	40002/3000/BM
				● ottone vintage/vintage brass	40002/3000/OV
		4000K		○ bianco/white	40002/4000/BI
				● nero/black	40002/4000/NE
				● oro perlato/pearl gold	40002/4000/AU
				● rame/copper	40002/4000/CU
				● bronzo materico/rough bronze	40002/4000/BM
				● ottone vintage/vintage brass	40002/3000/OV

LUNAOP

sospensione / suspension



watt	flusso/flux	CCT	Kg	colore/colour	codice/code
------	-------------	-----	----	---------------	-------------

LUNAOP Ø120

108W 24V	8400lm	2700K	5	bianco/white	40003/2700/BI	
				nero/black	40003/2700/NE	
				oro perlato/pearl gold	40003/2700/AU	
				rame/copper	40003/2700/CU	
				bronzo materico/rough bronze	40003/2700/BM	
				ottone vintage/vintage brass	40003/2700/OV	
	3000K				bianco/white	40003/3000/BI
					nero/black	40003/3000/NE
					oro perlato/pearl gold	40003/3000/AU
					rame/copper	40003/3000/CU
					bronzo materico/rough bronze	40003/3000/BM
					ottone vintage/vintage brass	40003/3000/OV
	4000K				bianco/white	40003/4000/BI
					nero/black	40003/4000/NE
					oro perlato/pearl gold	40003/4000/AU
					rame/copper	40003/4000/CU
					bronzo materico/rough bronze	40003/4000/BM
					ottone vintage/vintage brass	40003/3000/OV

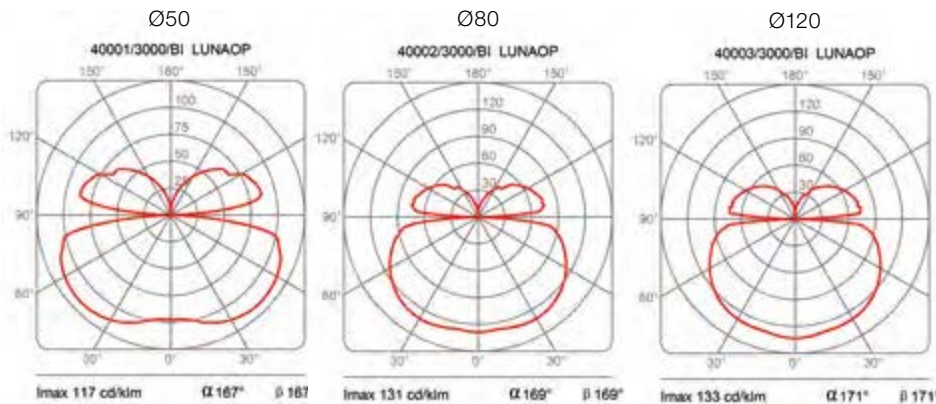
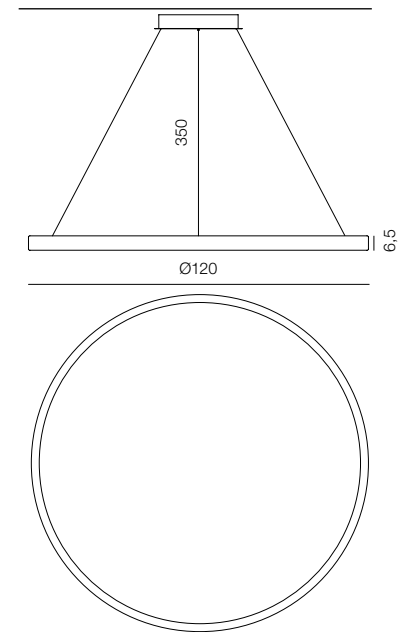



LUNAOP

rosone con alimentatore / ceiling rose with driver

Rosone per Lunaop da ordinare insieme all'anello con il wattaggio corrispondente alle lampade utilizzate.

È disponibile il dispositivo WiFi da inserire nel rosone per dimmerazione (codice 40204.1).

La scelta del codice del rosone nelle diverse composizioni è legato alla somma dei Watt dei singoli anelli ed al tipo di dimmerazione.

Ceiling rose support for Lunaop to be ordered together with the ring, and the corresponding wattage accordingly to the chosen lamps.

The WiFi device is available to be inserted in the ceiling rose (code 40204.1).

The choice of the ceiling rose in the different compositions code is related to the watts sum of the different rings and the type of dimmeration.



ROSONE 75W / CEILING ROSE 75W

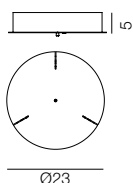

NON DIMMERABILE / NON DIMMABLE

	bianco/white	40004/BI
	nero/black	40004/NE
	oro perlato/pearl gold	40004/AU
	rame/copper	40004/CU
	bronzo mat./r. bronze	40004/BM
	ottone vint./vint. brass	40004/OV

DIMMERABILE / DIMMABLE push-dali

	bianco/white	40005/BI
	nero/black	40005/NE
	oro perlato/pearl gold	40005/AU
	rame/copper	40005/CU
	bronzo mat./r. bronze	40005/BM
	ottone vint./vint. brass	40005/OV

DIMMERABILE / DIMMABLE triac 3

	bianco/white	40013/BI
	nero/black	40013/NE
	oro perlato/pearl gold	40013/AU
	rame/copper	40013/CU
	bronzo mat./r. bronze	40013/BM
	ottone vint./vint. brass	40013/OV

Dispositivi remoti vedi pagina 527
Remote devices see page 527

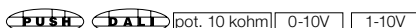

ALIMENTATORE REMOTO 75W / REMOTE DRIVER 75W

NON DIMMERABILE / NON DIMMABLE

	bianco/white	40004.1/BI
--	--------------	------------

DIMMERABILE / DIMMABLE push-dali

	bianco/white	40005.1/BI
--	--------------	------------

ESEMPI DI COMPOSIZIONE / EXAMPLES OF COMPOSITION

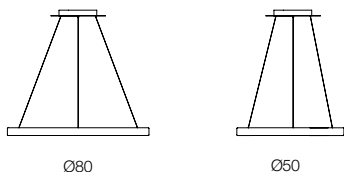

ROSONE 150W / CEILING ROSE 150W

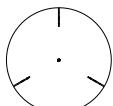
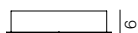

Ø31

NON DIMMERABILE / NON DIMMABLE

	bianco/white	40007/BI
	nero/black	40007/NE
	oro perlato/pearl gold	40007/AU
	rame/copper	40007/CU
	bronzo mat./r. bronze	40007/BM
	ottone vint./vint. brass	40007/OV

DIMMERABILE / DIMMABLE push-dali

	bianco/white	40008/BI
	nero/black	40008/NE
	oro perlato/pearl gold	40008/AU
	rame/copper	40008/CU
	bronzo mat./r. bronze	40008/BM
	ottone vint./vint. brass	40008/OV

DIMMERABILE / DIMMABLE triac 3

	bianco/white	40182/BI
	nero/black	40182/NE
	oro perlato/pearl gold	40182/AU
	rame/copper	40182/CU
	bronzo mat./r. bronze	40182/BM
	ottone vint./vint. brass	40182/OV

Dispositivi remoti vedi pagina 527
Remote devices see page 527

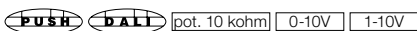

ALIMENTATORE REMOTO 150W / REMOTE DRIVER 150W

NON DIMMERABILE / NON DIMMABLE

	bianco/white	40007.1/BI
---	--------------	------------

DIMMERABILE / DIMMABLE push-dali

	bianco/white	40008.1/BI
---	--------------	------------

ESEMPI DI COMPOSIZIONE / EXAMPLES OF COMPOSITION

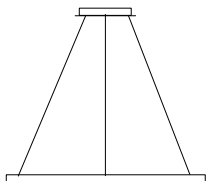

Ø120

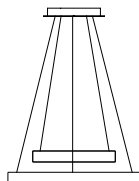

Ø50 - Ø80



ROSONE 2x150W / CEILING ROSE 2x150W

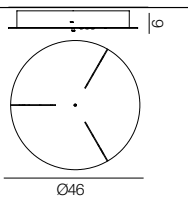

NON DIMMERABILE / NON DIMMABLE

- bianco/white 40010/BI
- nero/black 40010/NE
- oro perlato/pearl gold 40010/AU
- rame/copper 40010/CU
- bronzo mat./r. bronze 40010/BM
- ottone vint./vint. brass 40010/OV

DIMMERABILE / DIMMABLE push-dali

- bianco/white 40011/BI
- nero/black 40011/NE
- oro perlato/pearl gold 40011/AU
- rame/copper 40011/CU
- bronzo mat./r. bronze 40011/BM
- ottone vint./vint. brass 40011/OV

Dispositivi remoti vedi pagina 527
Remote devices see page 527

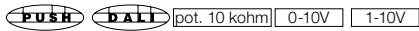

ESEMPI DI COMPOSIZIONE / EXAMPLES OF COMPOSITION

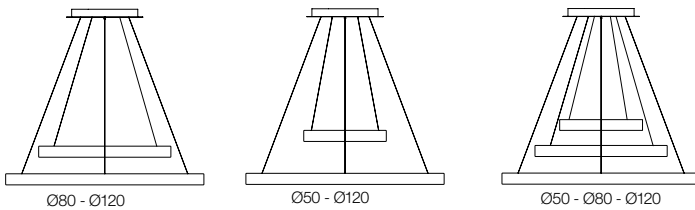



ROSONE 3x150W / CEILING ROSE 3x150W

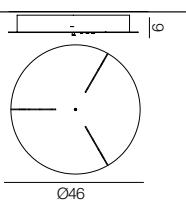

NON DIMMERABILE / NON DIMMABLE

- bianco/white 40014/BI
- nero/black 40014/NE
- oro perlato/pearl gold 40014/AU
- rame/copper 40014/CU
- bronzo mat./r. bronze 40014/BM
- ottone vint./vint. brass 40014/OV

DIMMERABILE / DIMMABLE push-dali

- bianco/white 40015/BI
- nero/black 40015/NE
- oro perlato/pearl gold 40015/AU
- rame/copper 40015/CU
- bronzo mat./r. bronze 40015/BM
- ottone vint./vint. brass 40015/OV

Dispositivi remoti vedi pagina 527
Remote devices see page 527

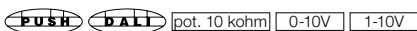

ESEMPI DI COMPOSIZIONE / EXAMPLES OF COMPOSITION

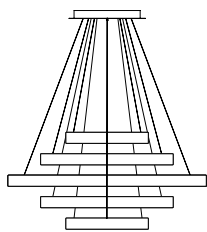

Ø50 - Ø80 - Ø120 - Ø80 - Ø50

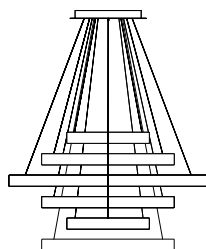

Ø50 - Ø80 - Ø120 - Ø80 - Ø50 - Ø80

LUNAOP

parete-soffitto / wall-ceiling

Lampada da soffitto o da parete a luce diffusa.
 Struttura in alluminio verniciato nel colore bianco.
 Diffusore in metacrilato opal bianco.
 Sorgente di luce a LED integrata, alimentatore elettronico dimmerabile nel rosone fissato al corpo lampada.
 Su richiesta senza rosone con alimentatore remoto.

Ceiling or wall lamp with diffused light.
 White lacquered aluminium structure.
 White opal methacrylate diffuser.
 Integrated LED light source and dimmable electronic driver inside the ceiling rose fixed to the body lamp.
 On request with remote driver and without ceiling rose.

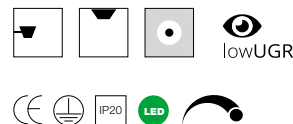

watt	flusso/flux	CCT	Kg	colore/colour	codice/code
------	-------------	-----	----	---------------	-------------

LUNAOP Ø50					
48W 230V	3700lm	3000K	2	○ bianco/white	2886/J/DIM/BI

alimentatore elettronico dimmerabile integrato / integrated electronic dimmable driver

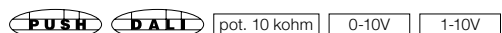

LUNAOP Ø80					
72W 230V	5600lm	3000K	3	○ bianco/white	2886/DIM/BI

alimentatore elettronico dimmerabile integrato / integrated electronic dimmable driver

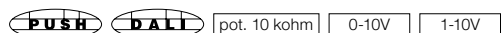

LUNAOP Ø120					
108W 230V	3700lm	8400K	5	○ bianco/white	2886/G/DIM/BI

alimentatore elettronico dimmerabile integrato / integrated electronic dimmable driver

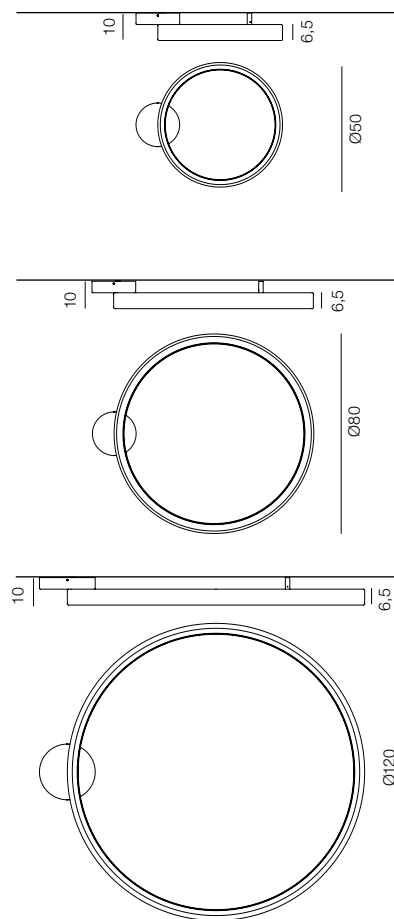
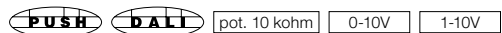

Ø50

Ø80

Ø120

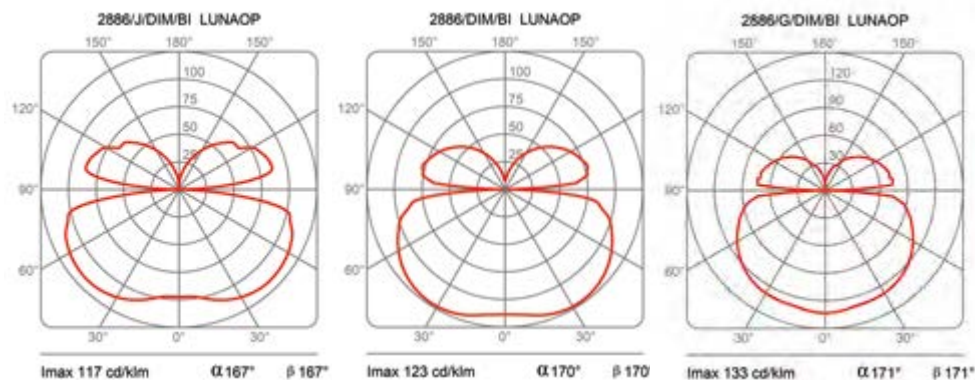



LUNAOP SLIM

LIGHTYOU LIKE

Versione slim della Lunaop a luce diffusa. Una sospensione con sorgente di luce a LED, minimale, con un alto rendimento luminoso, in tre diversi diametri, componibili in diverse combinazioni.

Slim version of the Lunaop with diffused light. A suspension lamp with LED light source, minimalist, with a high light efficiency, in three different diameters, which can be combined in different combinations.

Emiliana Martinelli

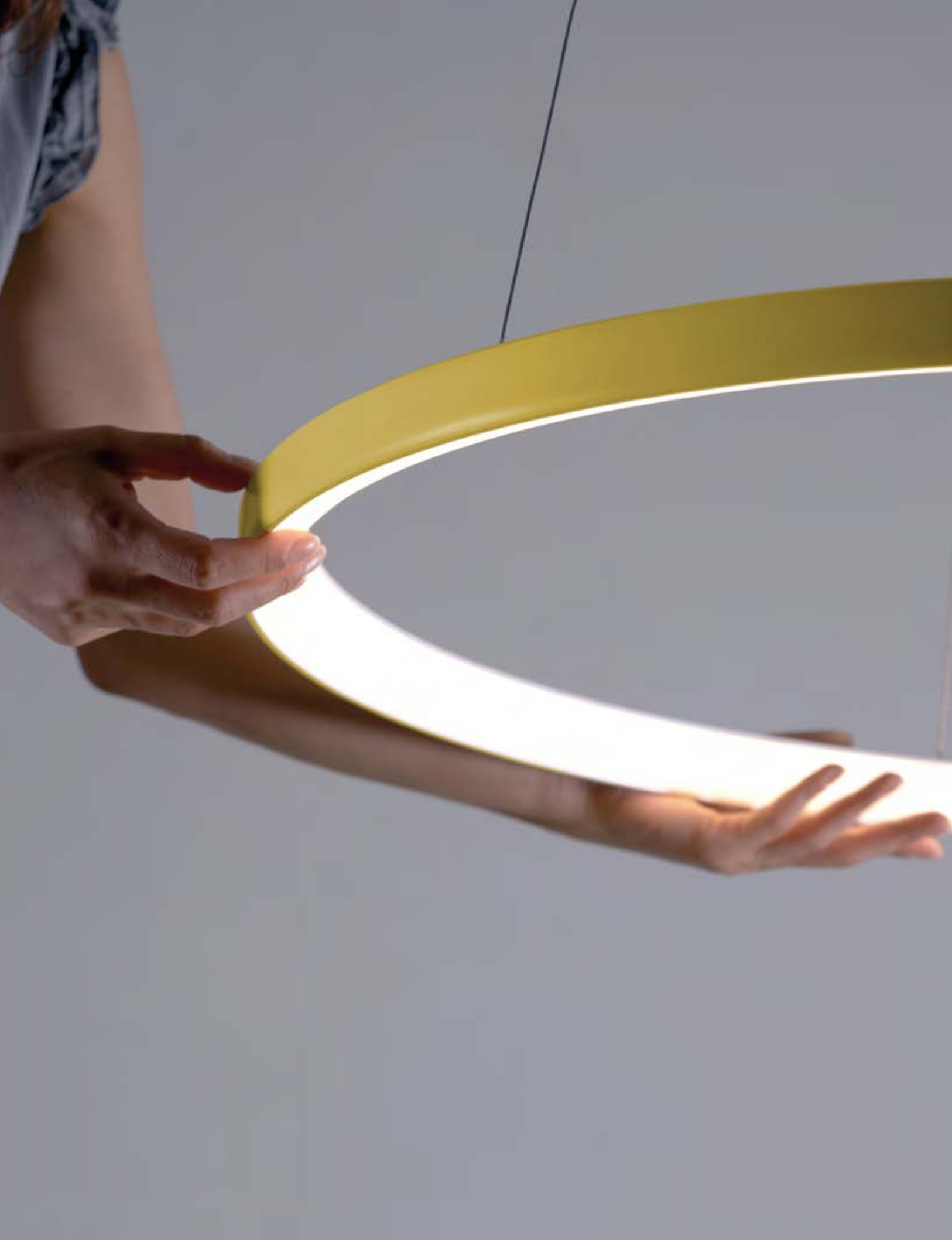





LUNAOP slim

sospensione / suspension

Lampada a sospensione di minime dimensioni a luce diffusa.

Struttura in alluminio verniciato nei colori bianco, nero, oro perlato o rame. Diffusore in metacrilato opal bianco. Disponibile in tre diametri (50, 80, 120) sospesa con i cavi di alimentazione da collegare ad un rosone da fissare al soffitto sia per la versione singola, sia per la versione composta (da 2 fino a 6 Lunaop).

Sorgente di luce a LED integrata a 2700K, 3000K o 4000K.

Alimentatore elettronico integrato nel rosone.

Suspension lamp of minimal dimensions with diffused light.

White, black, pearly gold or copper aluminium structure. White opal methacrylate diffuser.

Three diameters (50, 80, 120), suspended with power cables to be connected to a ceiling rose and mounted on the ceiling for both single and multiple versions (consisting of 2 to 6 Lunaop rings).

Integrated LED light source (2700K, 3000K or 4000K).

Electronic driver integrated in the ceiling rose.



watt	flusso/flux	CCT	Kg	colore/colour	codice/code
LUNAOP slim Ø50					
20,5W 24V	3515lm	2700K		bianco/white	40001/SL/2700/BI
				nero/black	40001/SL/2700/NE
				oro perlato/pearl gold	40001/SL/2700/AU
				rame/copper	40001/SL/2700/CU
				bronzo materico/rough bronze	40001/SL/2700/BM
				ottone vintage/vintage brass	40001/SL/2700/OV
		3000K		bianco/white	40001/SL/3000/BI
				nero/black	40001/SL/3000/NE
				oro perlato/pearl gold	40001/SL/3000/AU
				rame/copper	40001/SL/3000/CU
				bronzo materico/rough bronze	40001/SL/3000/BM
				ottone vintage/vintage brass	40001/SL/3000/OV
		4000K		bianco/white	40001/SL/4000/BI
				nero/black	40001/SL/4000/NE
				oro perlato/pearl gold	40001/SL/4000/AU
				rame/copper	40001/SL/4000/CU
				bronzo materico/rough bronze	40001/SL/4000/BM
				ottone vintage/vintage brass	40001/SL/4000/OV

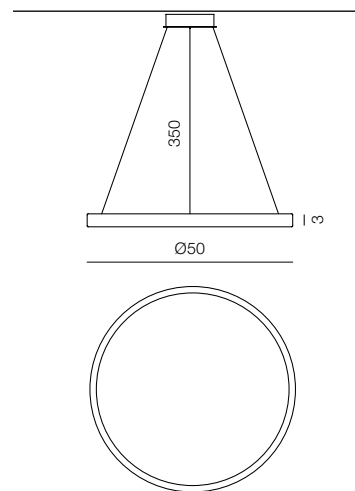

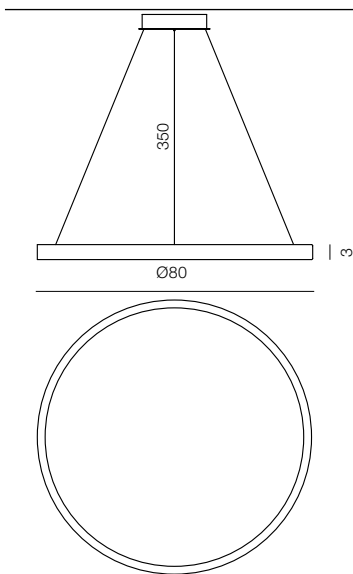

watt	flusso/flux	CCT	Kg	colore/colour	codice/code
LUNAOP slim Ø80					
33W 24V	5620lm	2700K		○ bianco/white	40002/SL/2700/BI
				● nero/black	40002/SL/2700/NE
				● oro perlato/pearl gold	40002/SL/2700/AU
				● rame/copper	40002/SL/2700/CU
				● bronzo materico/rough bronze	40002/SL/2700/BM
				● ottone vintage/vintage brass	40002/SL/2700/OV
		3000K		○ bianco/white	40002/SL/3000/BI
				● nero/black	40002/SL/3000/NE
				● oro perlato/pearl gold	40002/SL/3000/AU
				● rame/copper	40002/SL/3000/CU
				● bronzo materico/rough bronze	40002/SL/3000/BM
				● ottone vintage/vintage brass	40002/SL/3000/OV
		4000K		○ bianco/white	40002/SL/4000/BI
				● nero/black	40002/SL/4000/NE
				● oro perlato/pearl gold	40002/SL/4000/AU
				● rame/copper	40002/SL/4000/CU
				● bronzo materico/rough bronze	40002/SL/4000/BM
				● ottone vintage/vintage brass	40002/SL/4000/OV

LUNAOP slim
sospensione / suspension



watt	flusso/flux	CCT	Kg	colore/colour	codice/code
LUNAOP slim Ø120					
49W 24V	8400lm	2700K	○	bianco/white	40003/SL/2700/BI
			●	nero/black	40003/SL/2700/NE
			●	oro perlato/pearl gold	40003/SL/2700/AU
			●	rame/copper	40003/SL/2700/CU
			●	bronzo materico/rough bronze	40003/SL/2700/BM
			●	ottone vintage/vintage brass	40003/SL/2700/OV
		3000K	○	bianco/white	40003/SL/3000/BI
			●	nero/black	40003/SL/3000/NE
			●	oro perlato/pearl gold	40003/SL/3000/AU
			●	rame/copper	40003/SL/3000/CU
			●	bronzo materico/rough bronze	40003/SL/3000/BM
			●	ottone vintage/vintage brass	40003/SL/3000/OV
		4000K	○	bianco/white	40003/SL/4000/BI
			●	nero/black	40003/SL/4000/NE
			●	oro perlato/pearl gold	40003/SL/4000/AU
			●	rame/copper	40003/SL/4000/CU
			●	bronzo materico/rough bronze	40003/SL/4000/BM
			●	ottone vintage/vintage brass	40003/SL/4000/OV

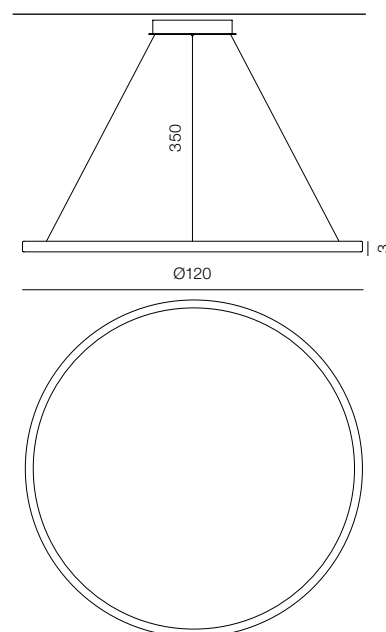



LUNAOP slim

rosone con alimentatore / ceiling rose with driver

Rosone per Lunaop da ordinare insieme all'anello con il wattaggio corrispondente alle lampade utilizzate.

È disponibile il dispositivo WiFi da inserire nel rosone per dimmerarla (codice 40204.1).

La scelta del codice del rosone nelle diverse composizioni è legato alla somma dei Watt dei singoli anelli ed al tipo di dimmerazione.

Ceiling rose support for Lunaop to be ordered together with the ring, and the corresponding wattage accordingly to the chosen lamps.

The WiFi device is available to be inserted in the ceiling rose (code 40204.1).

The choice of the ceiling rose in the different compositions code is related to the watts sum of the different rings and the type of dimmeration.



ROSONE 75W / CEILING ROSE 75W

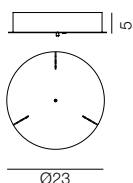

NON DIMMERABILE / NON DIMMABLE

	bianco/white	40004/BI
	nero/black	40004/NE
	oro perlato/pearl gold	40004/AU
	rame/copper	40004/CU
	bronzo mat./r. bronze	40004/BM
	ottone vint./vint. brass	40004/OV

DIMMERABILE / DIMMABLE push-dali

	bianco/white	40005/BI
	nero/black	40005/NE
	oro perlato/pearl gold	40005/AU
	rame/copper	40005/CU
	bronzo mat./r. bronze	40005/BM
	ottone vint./vint. brass	40005/OV

DIMMERABILE / DIMMABLE triac 3

	bianco/white	40013/BI
	nero/black	40013/NE
	oro perlato/pearl gold	40013/AU
	rame/copper	40013/CU
	bronzo mat./r. bronze	40013/BM
	ottone vint./vint. brass	40013/OV

Dispositivi remoti vedi pagina 527
Remote devices see page 527

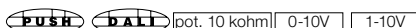

ALIMENTATORE REMOTO 75W / REMOTE DRIVER 75W

NON DIMMERABILE / NON DIMMABLE

	bianco/white	40004.1/BI
--	--------------	------------

DIMMERABILE / DIMMABLE push-dali

	bianco/white	40005.1/BI
--	--------------	------------

ESEMPI DI COMPOSIZIONE / EXAMPLES OF COMPOSITION

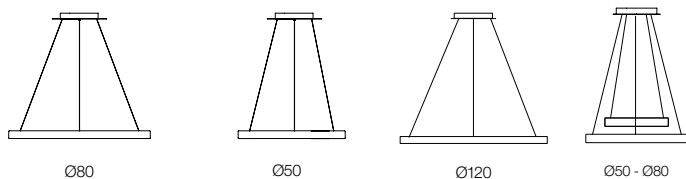



ROSONE 150W / CEILING ROSE 150W

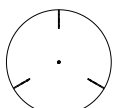

Ø31

NON DIMMERABILE / NON DIMMABLE

- bianco/white 40007/BI
- nero/black 40007/NE
- oro perlato/pearl gold 40007/AU
- rame/copper 40007/CU
- bronzo mat./r. bronze 40007/BM
- ottone vint./vint. brass 40007/OV

DIMMERABILE / DIMMABLE push-dali

- bianco/white 40008/BI
- nero/black 40008/NE
- oro perlato/pearl gold 40008/AU
- rame/copper 40008/CU
- bronzo mat./r. bronze 40008/BM
- ottone vint./vint. brass 40008/OV

DIMMERABILE / DIMMABLE triac 3

- bianco/white 40182/BI
- nero/black 40182/NE
- oro perlato/pearl gold 40182/AU
- rame/copper 40182/CU
- bronzo mat./r. bronze 40182/BM
- ottone vint./vint. brass 40182/OV

Dispositivi remoti vedi pagina 527
Remote devices see page 527

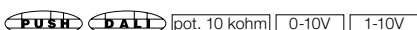

ALIMENTATORE REMOTO 150W / REMOTE DRIVER 150W

NON DIMMERABILE / NON DIMMABLE

- bianco/white 40007.1/BI

DIMMERABILE / DIMMABLE push-dali

- bianco/white 40008.1/BI

ESEMPI DI COMPOSIZIONE / EXAMPLES OF COMPOSITION

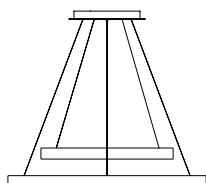

Ø80 - Ø120

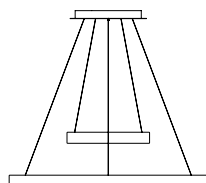

Ø50 - Ø120

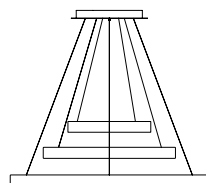

Ø50 - Ø80 - Ø120

LUNAOP slim

rosoni con alimentatore / ceiling rose with driver



ROSONE 2x150W / CEILING ROSE 2x150W

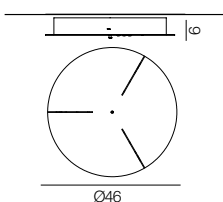

NON DIMMERABILE / NON DIMMABLE

- bianco/white 40010/BI
- nero/black 40010/NE
- oro perlato/pearl gold 40010/AU
- rame/copper 40010/CU
- bronzo mat./r. bronze 40010/BM
- ottone vint./vint. brass 40010/OV

DIMMERABILE / DIMMABLE push-dali

- bianco/white 40011/BI
- nero/black 40011/NE
- oro perlato/pearl gold 40011/AU
- rame/copper 40011/CU
- bronzo mat./r. bronze 40011/BM
- ottone vint./vint. brass 40011/OV

Dispositivi remoti vedi pagina 527
Remote devices see page 527

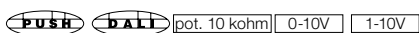

ESEMPI DI COMPOSIZIONE / EXAMPLES OF COMPOSITION

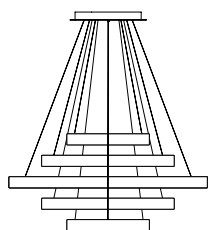

Ø50 - Ø80 - Ø120 - Ø80 - Ø50

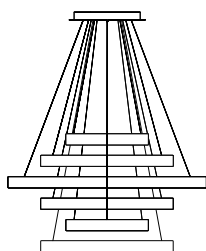

Ø50 - Ø80 - Ø120 - Ø80 - Ø50 - Ø80







LUNAOP slim verticale

sospensione / suspension

Lampada a sospensione a luce diffusa. Struttura in alluminio verniciato nei colori bianco, nero, oro perlato, rame, bronzo materico o ottone vintage. Con particolari tagli nell'anello. Diffusore in metacrilato opal bianco. Sospesa con i cavi di alimentazione da collegare ad un rosone da fissare al soffitto. Sorgente di luce a LED integrata a 2700K, 3000K. Alimentatore elettronico integrato nel rosone.

Suspension lamp with diffused light. White, black, pearly gold, copper, rough bronze or vintage brass aluminium structure. With special cuts in the ring. White opal methacrylate diffuser. Suspended with power cables to be connected to a ceiling rose and mounted on the ceiling. Integrated LED light source (2700K or 3000K). Electronic driver integrated in the ceiling rose.

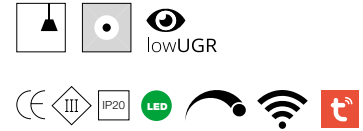

watt	flusso/flux	CCT	Kg	colore/colour	codice/code
33W 24V	5620lm	2700K	5	bianco/white	40193/SL/BI
				nero/black	40193/SL/NE
				oro p./p. gold	40193/SL/AU
				rame/copper	40193/SL/CU
				bronzo materico/rough bronze	40193/SL/BM
				ottone vintage/vintage brass	40193/SL/OV
				3000K	bianco/white
		nero/black	40193/SL/3000/NE		
		oro p./p. gold	40193/SL/3000/AU		
		rame/copper	40193/SL/3000/CU		
		bronzo materico/rough bronze	40193/SL/3000/BM		
		ottone vintage/vintage brass	40193/SL/3000/OV		

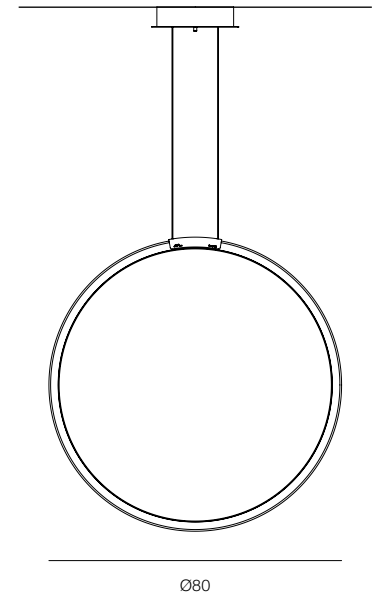

ROSONI / CEILING ROSES



Rosone non dimmerabile / Non dimmable ceiling rose

75W 230/24V	bianco/white	40194/BI
	nero/black	40194/NE
	oro p./p. gold	40194/AU
	rame/copper	40194/CU
	bronzo materico/rough bronze	40194/BM
	ottone vintage/vintage brass	40194/OV

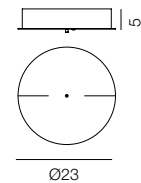

Dispositivi remoti vedi pagina 527 / Remote devices see page 527

Rosone dimmerabile / Dimmable ceiling rose

75W 230/24V	bianco/white	40195/BI
	nero/black	40195/NE
	oro p./p. gold	40195/AU
	rame/copper	40195/CU
	bronzo materico/rough bronze	40195/BM
	ottone vintage/vintage brass	40195/OV



CIRCULAR SLIM

Un anello sottile e leggero che emette una luce diffusa indiretta. Disponibile in diversi diametri, lo puoi utilizzare sia da solo, sia in composizioni personalizzate, oppure secondo le geometrie tridimensionali che la fantasia e le necessità illuminotecniche ti suggeriscono.

A thin and light ring that emits a indirect diffused light. Available with different diameters, you can use it either alone, or in customised compositions, or according to the three-dimensional geometries/layouts that your imagination and lighting needs suggest.

Emiliana Martinelli



CIRCULAR SLIM

sospensione / suspension

Lampada a sospensione a luce indiretta, in alluminio verniciato nel colore bianco, oro perlato e rame. Sospeso con i cavi di alimentazione da collegare al rosone. Alimentatori elettronici dimmerabili inseriti all'interno del rosone a soffitto. A richiesta con LED bianco dinamico. Disponibile in tre dimensioni.

Suspension lamp, indirect light, painted aluminium in white, pearly gold and copper colours. Suspended with power cables to be connected to a ceiling rose. Electronic dimmable drivers inside the ceiling rose. On request with dynamic white LED. Available in three sizes.



watt	flusso/flux	CCT	Kg	colore/colour	codice/code
CIRCULAR SLIM Ø65					
50W 230V	6000lm	3000K	4	○ bianco/white	2004/SL/65/DIM/L/1/BI
				● oro p.p. gold	2004/SL/65/DIM/L/1/AU
				● rame/copper	2004/SL/65/DIM/L/1/CU

rosone / ceiling rose Ø23 H 5
alimentatori elettronici dimmerabili / electronic dimmable drivers

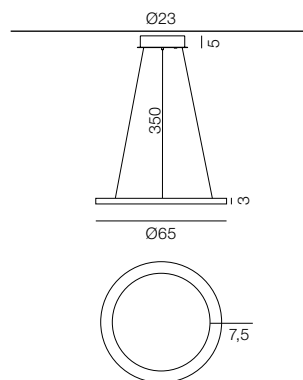
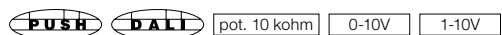

CIRCULAR SLIM Ø95					
75W 230V	9000lm	3000K	5	○ bianco/white	2004/SL/95/DIM/L/1/BI
				● oro p.p. gold	2004/SL/95/DIM/L/1/AU
				● rame/copper	2004/SL/95/DIM/L/1/CU

rosone / ceiling rose Ø23 H 5
alimentatori elettronici dimmerabili / electronic dimmable drivers

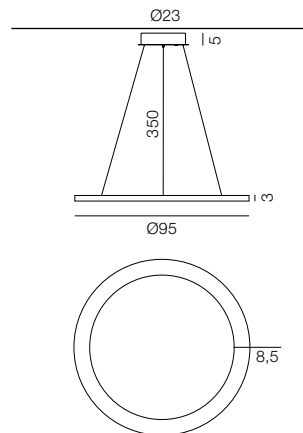
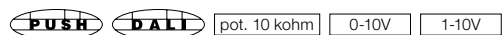

CIRCULAR SLIM Ø125					
112W 230V	13500lm	3000K	6	○ bianco/white	2004/SL/125/DIM/L/1/BI
				● oro p.p. gold	2004/SL/125/DIM/L/1/AU
				● rame/copper	2004/SL/125/DIM/L/1/CU

rosone / ceiling rose Ø23 H 5
alimentatori elettronici dimmerabili / electronic dimmable drivers

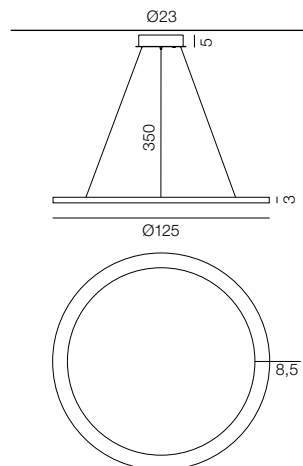
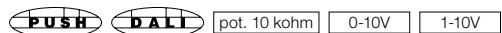



Ø65

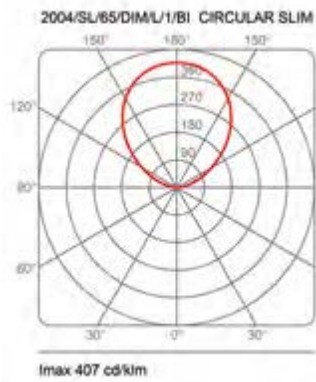

Ø95

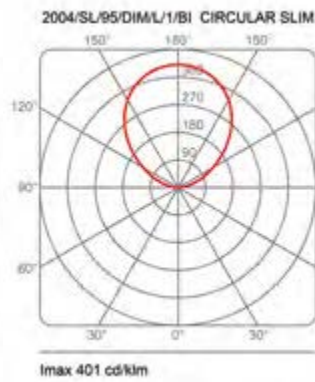

Ø125

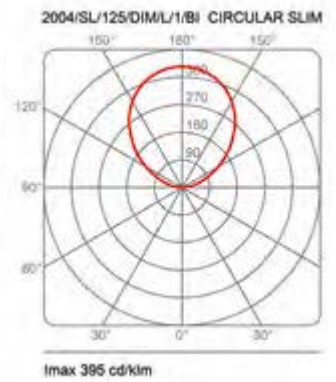

LUNA

Un disco luminoso in due diversi diametri scandisce lo spazio. La lampada è definita da una cornice in alluminio verniciato, da un grande diffusore e caratterizzata da un anello in metacrilato nel colore bianco o arancio.

A bright disc available in two different diameters articulates the space. The lamp is defined by a frame in lacquered aluminium, a large diffuser and it is characterized by a methacrylate ring available in white or orange.

Emiliana Martinelli



LUNA

soffitto / ceiling



Lampada da soffitto a luce diffusa. Struttura in alluminio, anello superiore in metacrilato nei colori bianco o arancio, diffusore in metacrilato opal bianco.
Sorgente di luce a LED integrata.
Completo di alimentatori elettronici dimmerabili.

Ceiling lamp diffused light. Aluminium structure, methacrylate superior ring in white or orange colour, white opal methacrylate diffuser, ring diffuser.
Integrated LED light source.
Complete of dimmable electronic drivers.



watt	flusso/flux	CCT	Kg	colore/colour	codice/code
LUNA Ø50	con anello superiore in metacrilato / methacrylate upper ring version				
21W 230V	2650lm	3000K	6	○ bianco-bianco/white-white	2862/J/DIM/L/1/BI/BI
				● bianco-arancio/white-orange	2862/J/DIM/L/1/BI/AR

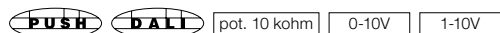
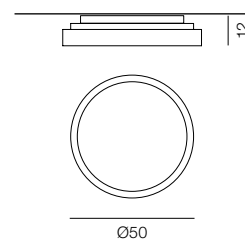

LUNA Ø80	con anello superiore in metacrilato / methacrylate upper ring version				
79W 230V	9100lm	3000K	9	○ bianco-bianco/white-white	2862/M/DIM/L/1/BI/BI
				● bianco-arancio/white-orange	2862/M/DIM/L/1/BI/AR

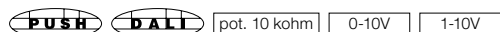
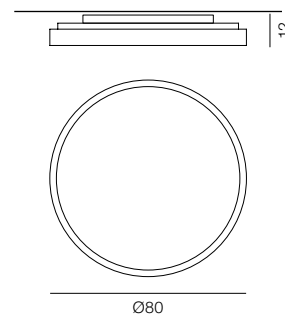

a richiesta con emergenza / emergency lighting on request.

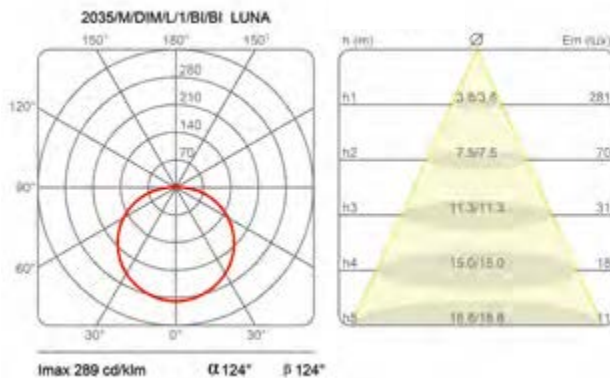
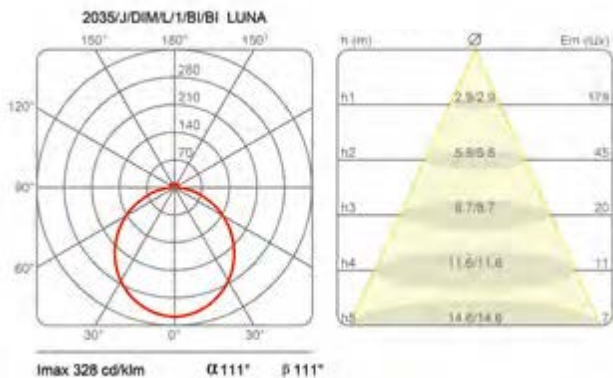



MAMBA

Una presenza discreta e leggera che con moduli componibili stampati con la tecnologia rotazionale, in polietilene, curvi, ad angolo e lineari delimita, caratterizza e illumina, un percorso, un'architettura, spazi commerciali e privati.

A discrete, lightweight presence that, with its rotational-molding technology of modular components in polyethylene, curved, angular and linear, defines, characterizes and illuminates an architectural space, commercial and private settings.

Emiliana Martinelli







Tribes Store, Castellana Grotte, Bari – architetto Alessandra Notarangelo













MAMBA

moduli / modules

Sistema componibile a luce diffusa, formato da moduli e giunti per il collegamento.
Struttura in polietilene, stampata con la tecnologia rotazionale.
Sorgente di luce a LED integrata.
Da collegare all'alimentatore elettronico dimmerabile inserito nel controsoffitto, remoto o all'interno del rosone al soffitto.

Modular system with diffused light, composed of modules and joints. Polyethylene structure, printed with rotational molding technology.
Integrated Led light source.
The modules must be connected to the dimmable electronic driver, which can be placed inside the ceiling rose, the false ceiling or remotely.

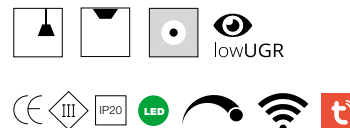

watt	flusso/flux	CCT	Kg	colore/colour	codice/code
MODULO CURVO / CURVED MODULE 30°					
25W 24V	3000lm	2700K	1,5	○ bianco/white	40135/2700/BI
		3000K		○ bianco/white	40135/BI
		4000K		○ bianco/white	40135/4000/BI
MODULO CURVO / CURVED MODULE 60°					
25W 24V	3000lm	2700K	1,5	○ bianco/white	40020/2700/BI
		3000K		○ bianco/white	40020/BI
		4000K		○ bianco/white	40020/4000/BI
MODULO CURVO / CURVED MODULE 90°					
12,5W 24V	1500lm	2700K	1	○ bianco/white	40053/2700/BI
		3000K		○ bianco/white	40053/BI
		4000K		○ bianco/white	40053/4000/BI
MODULO CURVO / CURVED MODULE 120°					
25W 24V	3000lm	2700K	1,5	○ bianco/white	40021/2700/BI
		3000K		○ bianco/white	40021/BI
		4000K		○ bianco/white	40021/4000/BI
MODULO LINEARE / LINEAR MODULE					
25W 24V	3000lm	2700K	1,5	○ bianco/white	40022/2700/BI
		3000K		○ bianco/white	40022/BI
		4000K		○ bianco/white	40022/4000/BI

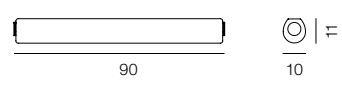
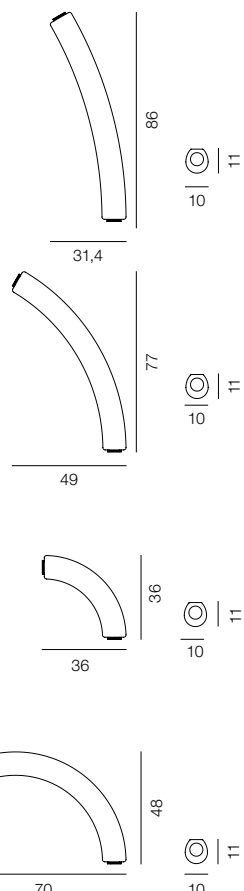



GIUNTI DI COLLEGAMENTO TRA MODULI / CONNECTION JOINTS BETWEEN MODULES

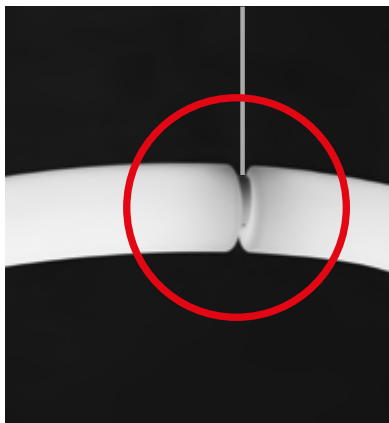

KIT DI SOSPENSIONE / SUSPENSION KIT

- A) giunto intermedio con cavo di sospensione / intermediate joint with hanging cable 40026/BI
- B) testata terminale con cavo di sospensione / terminal head with hanging cable 40027/BI
- connettore elettrico tra moduli / electronic connection for modules 40028/BI

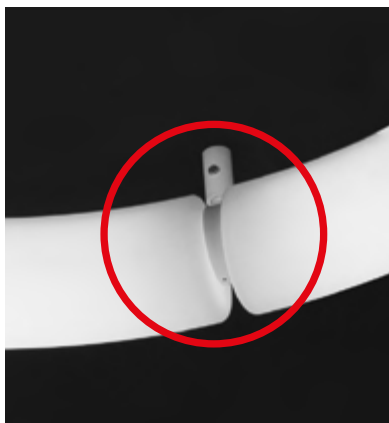
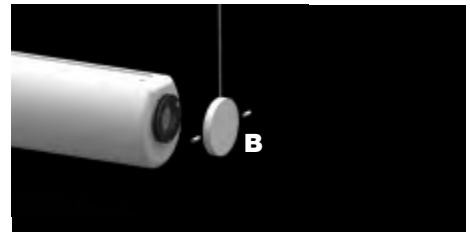
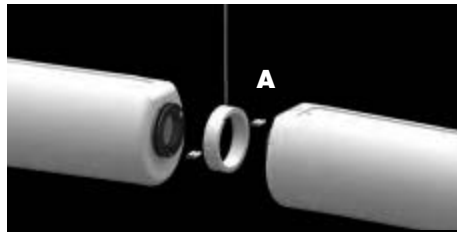

KIT SOFFITTO O PARETE / CEILING OR WALL KIT

- C) giunto intermedio con supporto / intermediate joint with support 40047/BI
- D) testata terminale con supporto / terminal head with support 40048/BI
- connettore elettrico tra moduli / electronic connection for modules 40028/BI

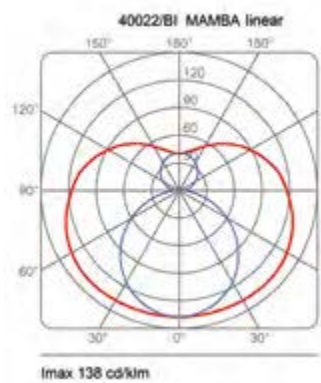
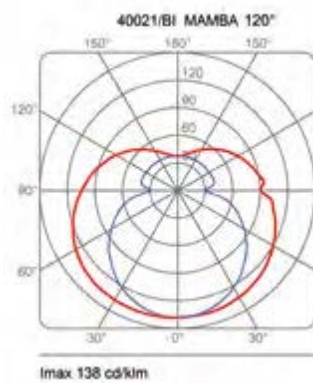
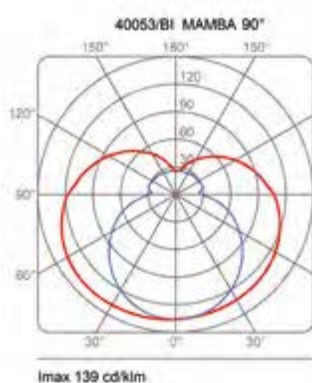
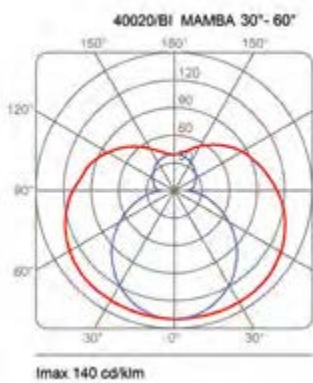
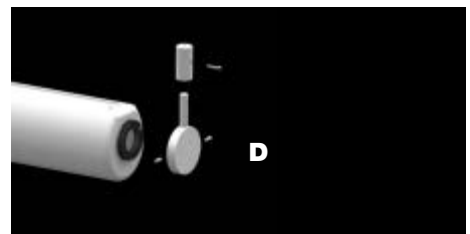
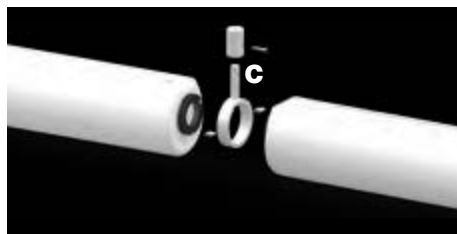

MAMBA

esempi di composizione a sospensione / examples of suspension lamp compositions

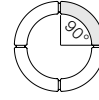

ANELLO / RING Ø70:
4 moduli/modules 90° 40053/BI
1 rosone/ceiling rose 40124/BI-40124/DIM/BI
4 giunti intermedi/intermediate joints 40026/BI
3 connettori elettr./ electr. connectors 40028/BI

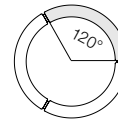

ANELLO / RING Ø95:
3 moduli/modules 120° 40021/BI
1 rosone/ceiling rose 40023/BI-40023/DIM/BI
3 giunti intermedi/intermediate joints 40026/BI
2 connettori elettr./ electr. connectors 40028/BI

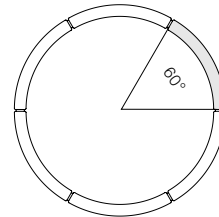
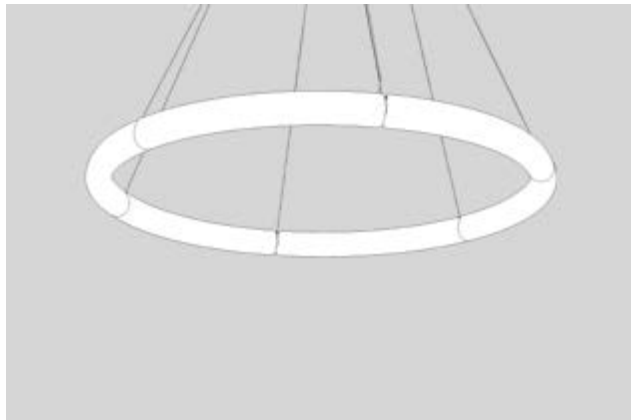

ANELLO / RING Ø180:
6 moduli/modules 60° 40020/BI
1 rosone/ceiling rose 40024/BI-40024/DIM/BI
6 giunti intermedi/intermediate joints 40026/BI
5 connettori elettr./ electr. connectors 40028/BI

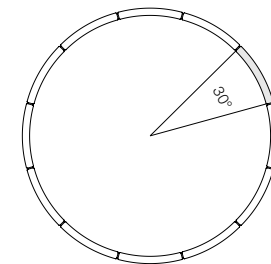
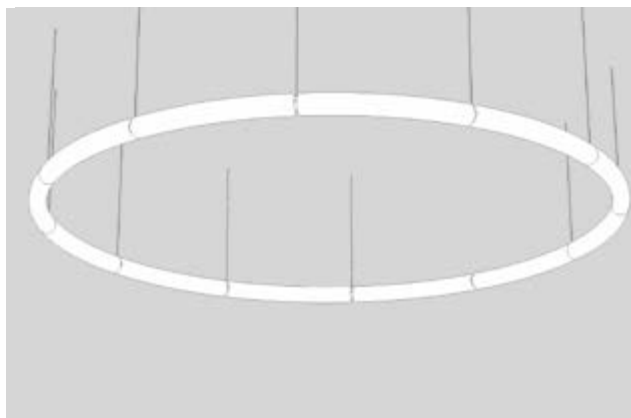

ANELLO / RING Ø352:
12 moduli/modules 30° 40135/BI
1 rosone/ceiling rose 40147/BI - 40147/DIM/BI
12 giunti intermedi/intermediate joints 40026/BI
11 connettori elettr./ electr. connectors 40028/BI

MAMBA

esempi di composizione a sospensione / examples of suspension lamp compositions

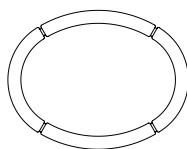

OVALE / OVAL 140x107
2 moduli/modules 60° 40020/BI
2 moduli/modules 120° 40021/BI
1 rosone/ceiling rose 40024.1/BI
4 giunti intermedi/intermediate joints 40026/BI
3 connettori elettr./ electr. connectors 40028/BI

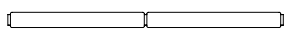
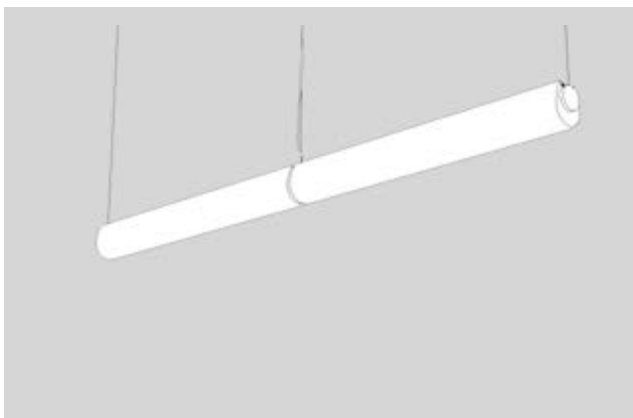

LINEARE / LINEAR
2 moduli/modules 40022/BI
1 rosone/ceiling rose 40124.1/BI
1 giunto intermedio/intermediate joint 40026/BI
2 giunti terminali/ terminal joints
1 connettori elettr./ electr. connectors 40028/BI

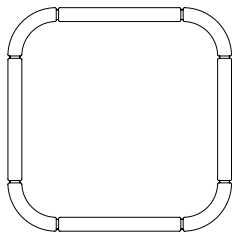
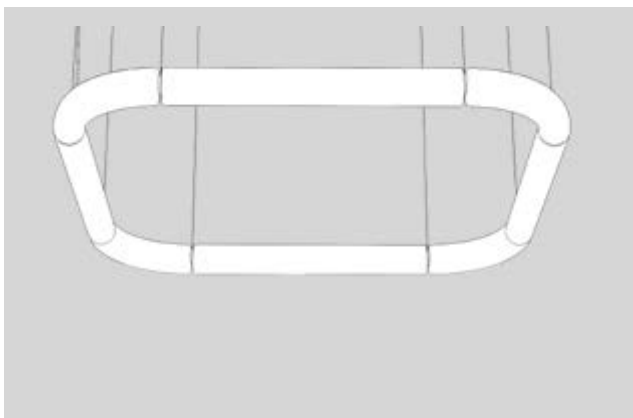

QUADRATO / SQUARE 161x161
4 moduli/modules 90° 40053/BI
4 moduli/modules 40022/BI
1 rosone/ceiling rose 40024.1/BI-40025
8 giunti intermedi/intermediate joints 40026/BI
7 connettori elettr./ electr. connectors 40028/BI

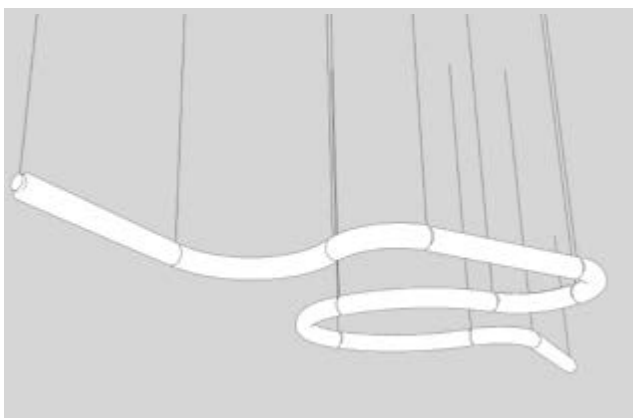

SINUOSO / SINUOUS
composizione libera/free composition



CIRCULAR POL

Una serie di anelli di luce di diverso diametro sospesi per illuminare ampi spazi architettonici. Con un grande foro centrale, in gruppo o solitari, definiscono un luogo senza interrompere la visuale.

A series of pendant multi-diameter rings of light to illuminate large architectural spaces. With a large central hole, whether in a group or alone, they define an environment without interrupting the view.

Emiliana Martinelli



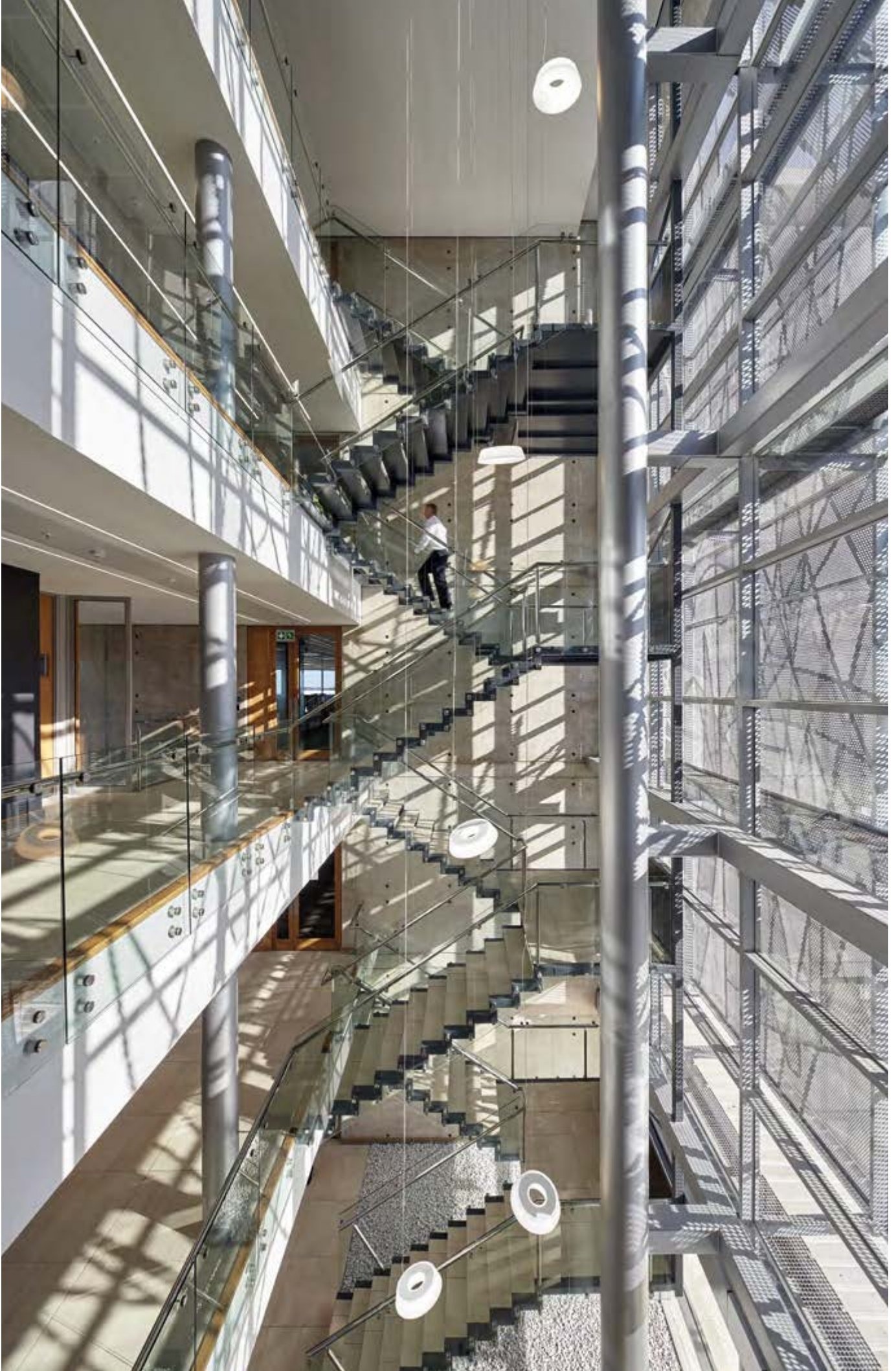



Centro Commerciale Jubilee Mall, Sud Africa

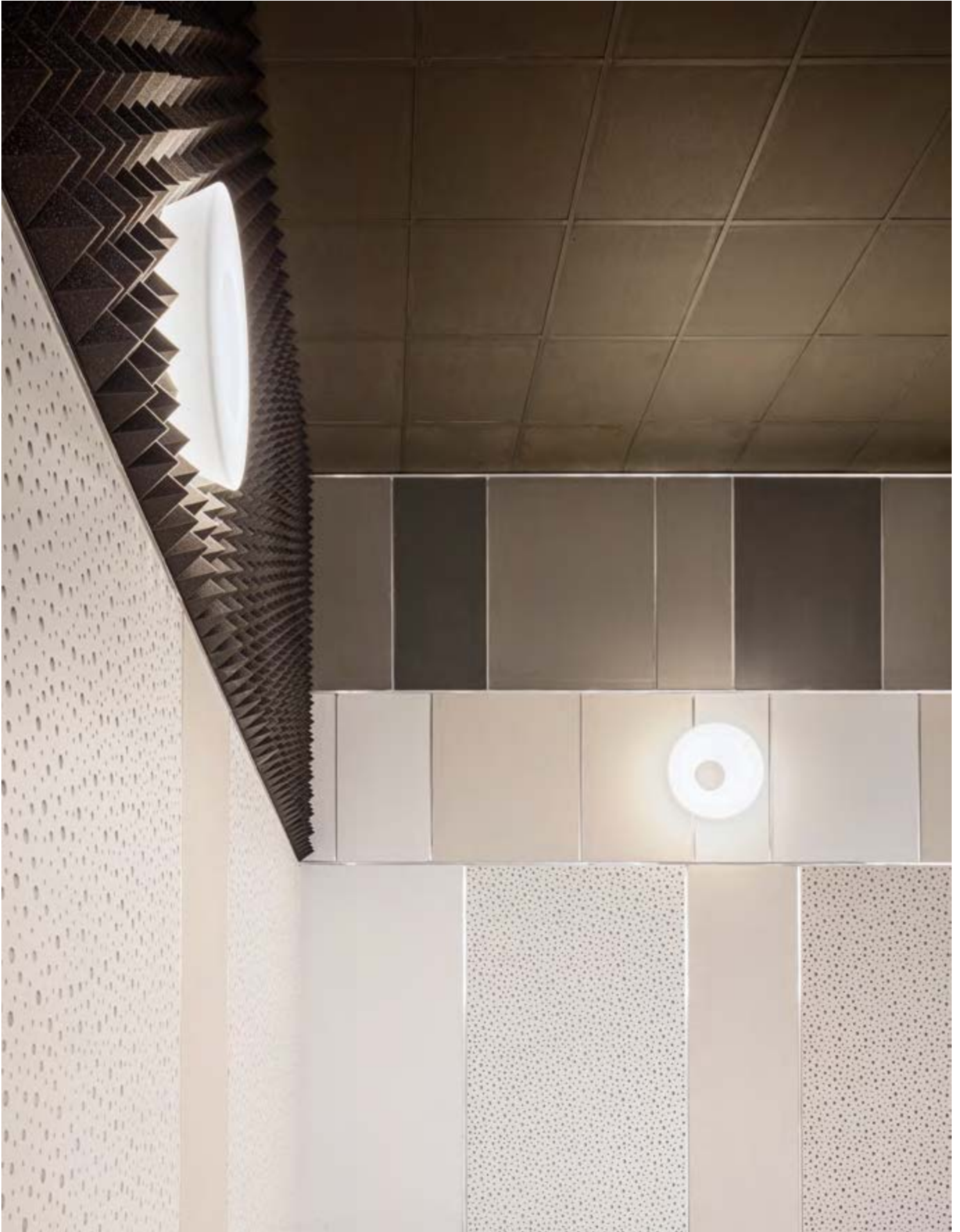



CIRCULAR POL

sospensione / suspension lamp



Lampada a sospensione a luce diffusa.
Struttura in polietilene bianco stampato con la tecnologia rotazionale.
Sorgente di luce a LED integrata.
Completa di alimentatori elettronici dimmerabili fissati all'interno del rosone a soffitto.
Disponibile in tre diversi diametri.

Suspension lamp, diffused light.
White polyethylene structure printed with rotational molding technology.
Integrated LED light source.
Complete with electronic dimmable drivers placed inside the ceiling rose.
Available in three different diameters.



watt	flusso/flux	CCT	Kg	colore/colour	codice/code
------	-------------	-----	----	---------------	-------------

CIRCULAR POL Ø52

26W 230V	3200lm	3000K	3,5	○ bianco/white	2057/XS/DIM/L/1/BI
----------	--------	-------	-----	----------------	--------------------

rosone / ceiling rose Ø22 H 5

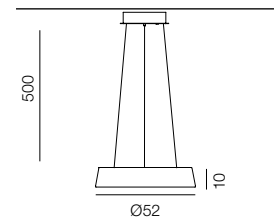

CIRCULAR POL Ø90

60W 230V	6750lm	3000K	8	○ bianco/white	2057/J/DIM/L/1/BI
----------	--------	-------	---	----------------	-------------------

rosone / ceiling rose Ø22 H 5

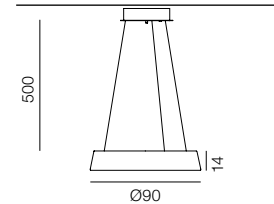

CIRCULAR POL Ø150

105W 230V	10000lm	3000K	20	○ bianco/white	2057/DIM/L/1/BI
-----------	---------	-------	----	----------------	-----------------

rosone / ceiling rose Ø26 H 5

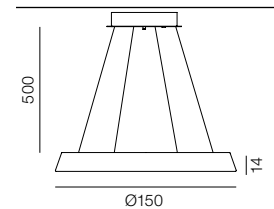

alimentatori elettronici dimmerabili integrati / integrated electronic dimmable drivers



Ø52

Ø90

Ø150

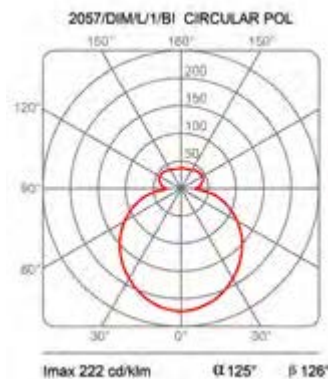
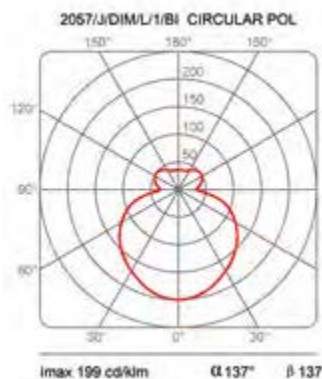
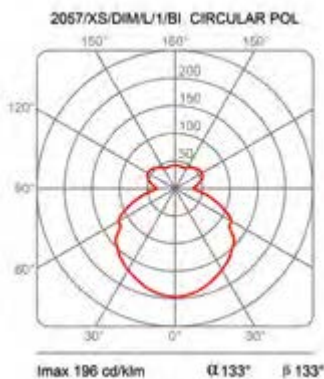



CIRCULAR POL

parete-soffitto / wall-ceiling

Lampada da soffitto/parete a luce diffusa.
Struttura in polietilene bianco stampato con
la tecnologia rotazionale. Base in alluminio
verniciato.

Sorgente di luce a LED integrata.

Completa di alimentatore elettronico
dimmerabile all'interno del corpo lampada.

Ceiling/wall lamp, diffused light.

White polyethylene structure printed with
rotational molding technology. Painted
aluminium base.

Integrated Led light source.

Complete with electronic dimmable driver inside
the body lamp.



watt	flusso/flux	CCT	Kg	colore/colour	codice/code
CIRCULAR POL					
26W 230V	3200lm	3000K	3,5	○ bianco/white	2878/DIM/L/1/BI

alimentatori elettronici dimmerabili integrati / integrated electronic dimmable drivers

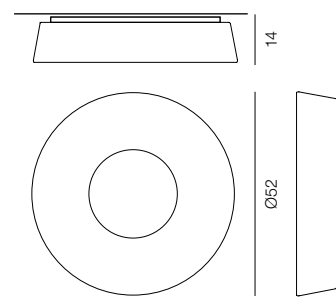

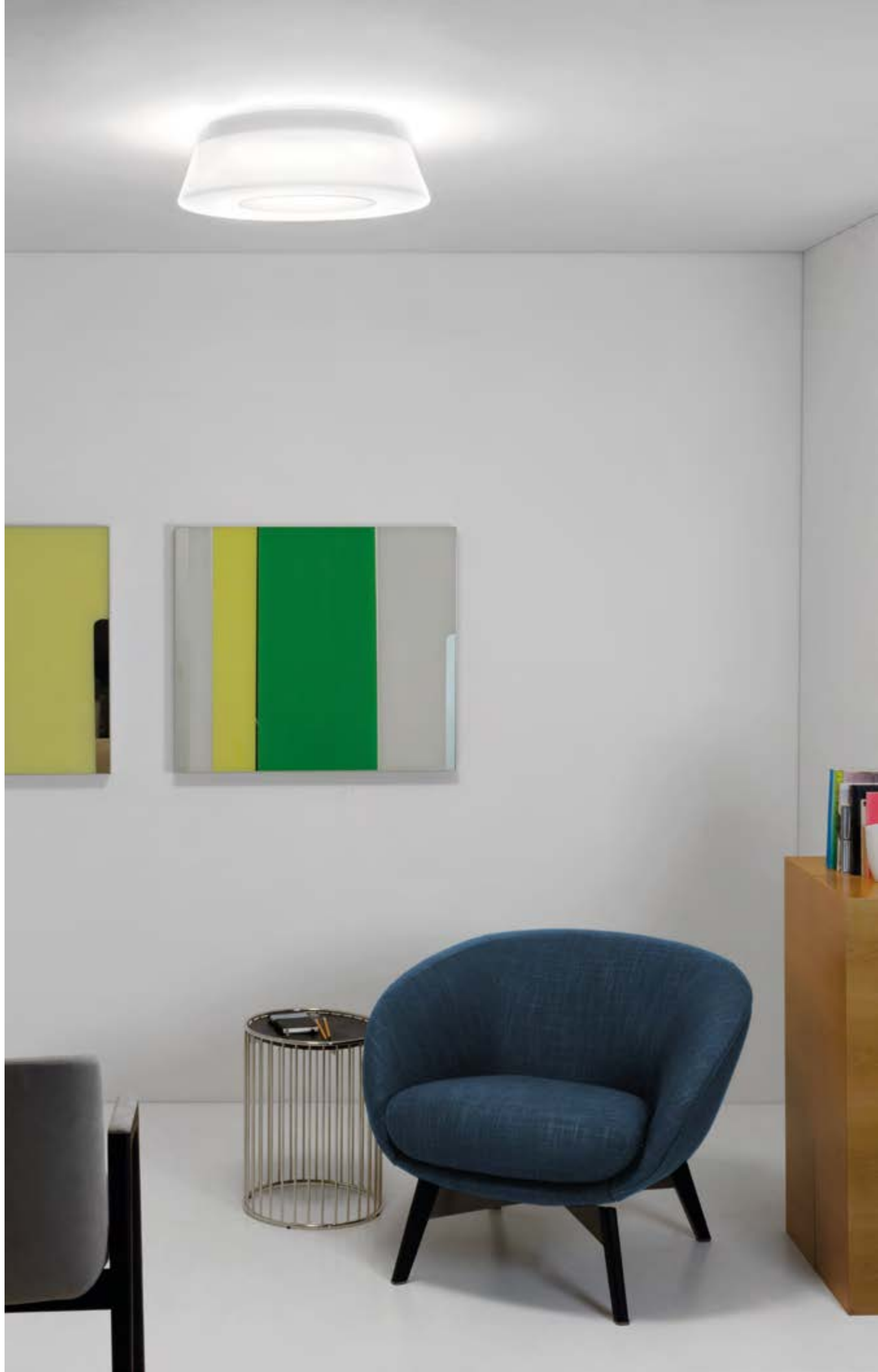

CIRCULAR POL XXL

Sistema di lampade a sospensione componibili a luce diffusa che comprende moduli lineari, curvi ed angolari. La combinazione dei moduli consente di creare percorsi sinuosi e lineari di varia lunghezza in modo da seguire l'andamento dell'architettura, o formare anelli di diverso diametro, descrivere quadrati o dare vita a configurazioni più complesse.

I moduli, collegati e distanziati tra di loro da un particolare giunto in metallo completo di cavo in acciaio per la sospensione, evidenziano e caratterizzano la composizione che si viene a creare, in base ad ogni singolo progetto.

A system with fitted suspension lamps and diffused light which includes linear, curved and regular modules.

By combining the modules it is possible to create sinuous and linear paths with different lengths in order to follow the architecture trend or to set up rings with different diameters, to describe squares or to create more complex configurations.

The modules, connected and spaced out by a special metal joint equipped with steel cables for the suspension, emphasize and distinguish the composition that is created, depending on each project.

Emiliana Martinelli



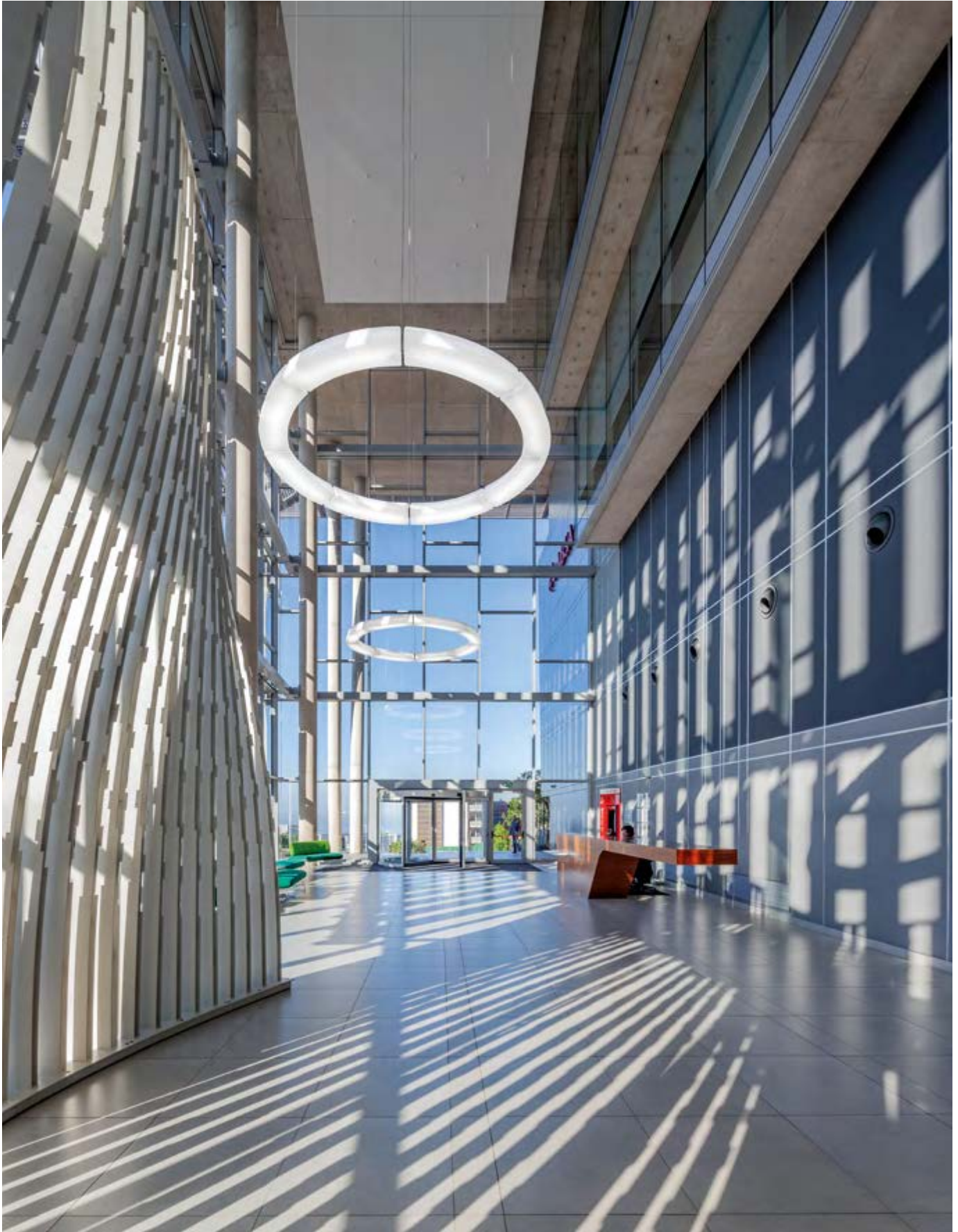



Aeroporto, Marrakech Menara, Marocco – arch. Abdou Lahlou & Associates

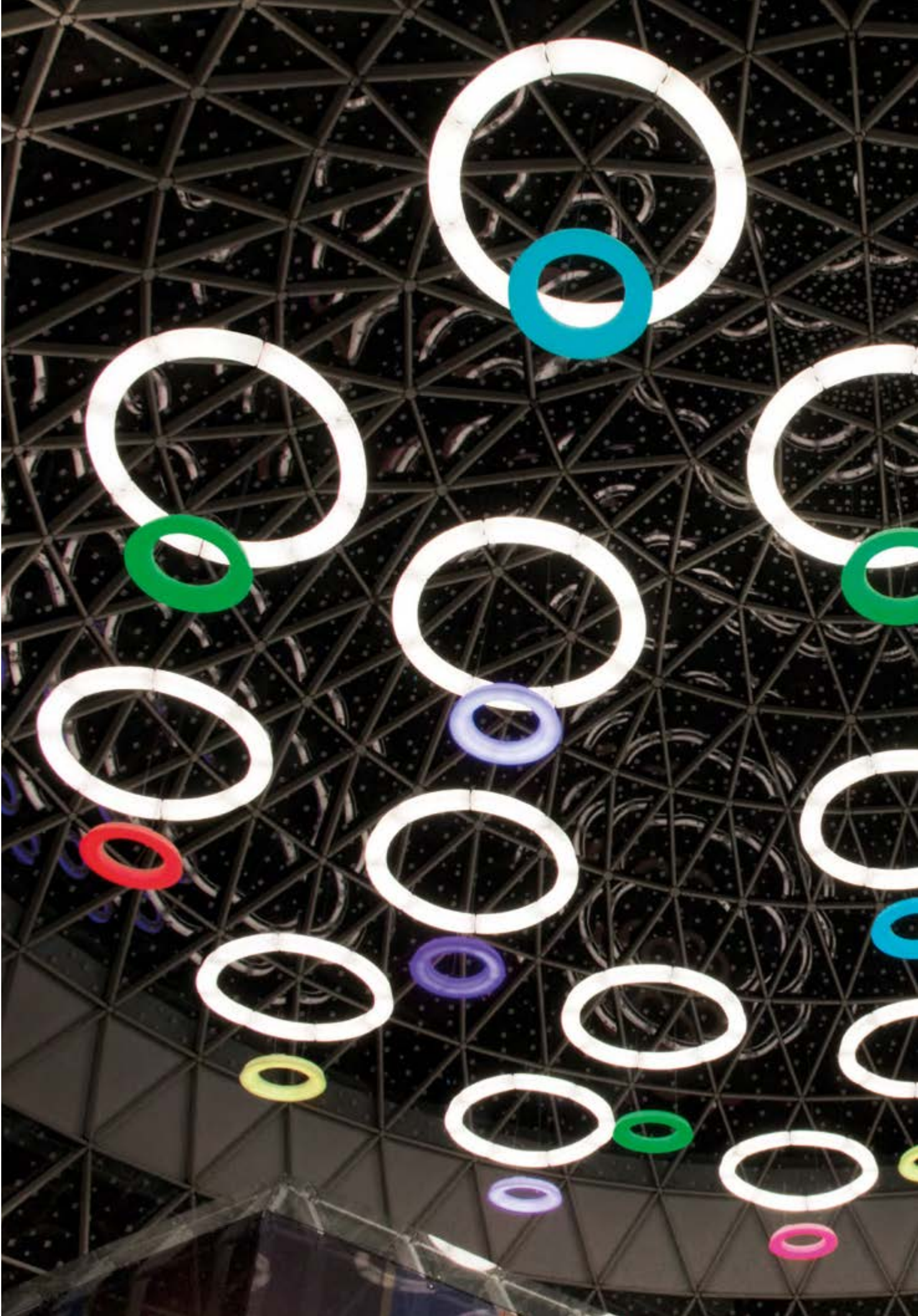



CIRCULAR POL XXL

Sala polivalente, Luzzara - architetto Alessio Bernardelli

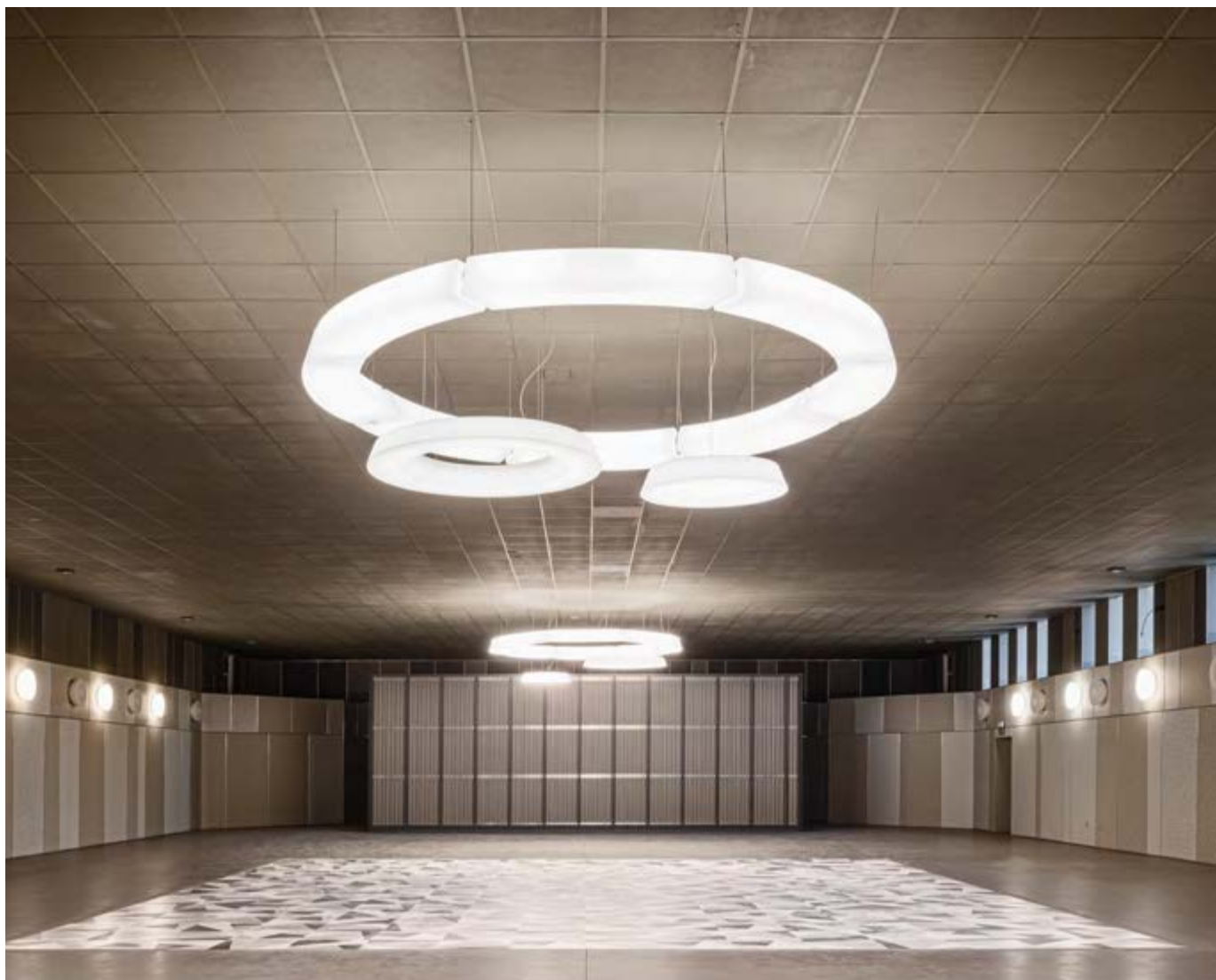







CIRCULAR POL XXL

moduli / modules

Sistema componibile a luce diffusa con moduli lineari, angolari e curvi da combinare per comporre varie configurazioni. Sospesi con cavi in acciaio, stampati in rotazionale, materiale polietilene e con giunti in alluminio per il collegamento dei moduli. Sorgente di luce a LED integrata. Alimentatori elettronici dimmerabili all'interno dei moduli.

Modular system, diffused light: angular, linear, curved modular lighting device for different configurations. Suspended with steel cables, printed with rotational molding technology with polyethylene material, aluminium joints for connecting the modules. Integrated LED light source. Dimmable electronic drivers inside the modules.



watt	flusso/flux	CCT	Kg	colore/colour	codice/code
------	-------------	-----	----	---------------	-------------

MODULO LINEARE / LINEAR MODULE

60W 230V	6750lm	3000K	8	○ bianco/white	40828/L/1/BI
----------	--------	-------	---	----------------	--------------

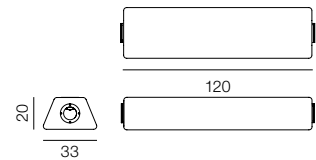

MODULO CURVO 45° / CURVED MODULE 45°

60W 230V	6750lm	3000K	8	○ bianco/white	40829/L/1/BI
----------	--------	-------	---	----------------	--------------

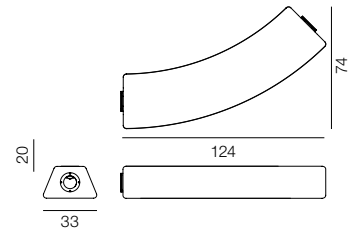

MODULO ANGOLARE 90° / ANGULAR MODULE 90°

20W 230V	2250lm	3000K	4	○ bianco/white	40854/L/1/BI
----------	--------	-------	---	----------------	--------------

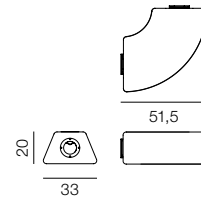

alimentatori elettronici dimmerabili integrati / integrated electronic dimmable drivers

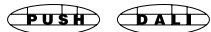

LINEARE / LINEAR

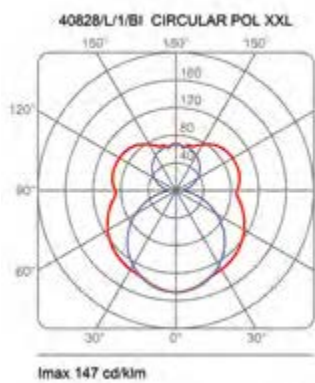

45°

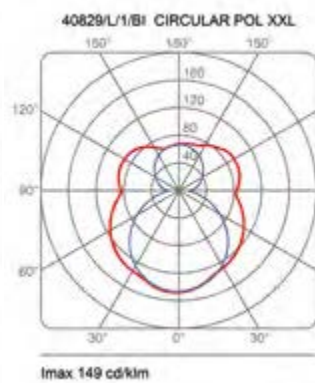

90°

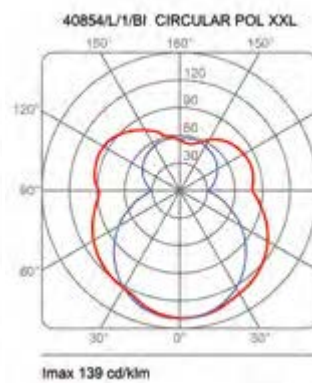



GIUNTI DI COLLEGAMENTO TRA MODULI / CONNECTION JOINTS BETWEEN MODULES

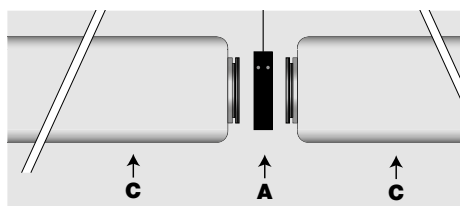

A) giunto intermedio con cavo di sospensione in acciaio.
intermediate joint with suspension cable in steel.

40831/GR

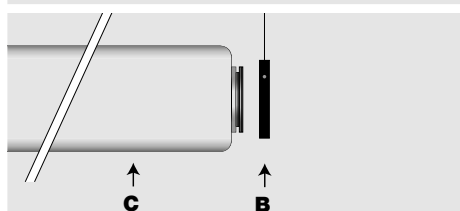

B) testata terminale con cavo di sospensione in acciaio.
closing head cover with steel suspension cable.

40830/GR

C) modulo diffusore lineare, curvo o angolare.
curved, linear or angular module diffuser.

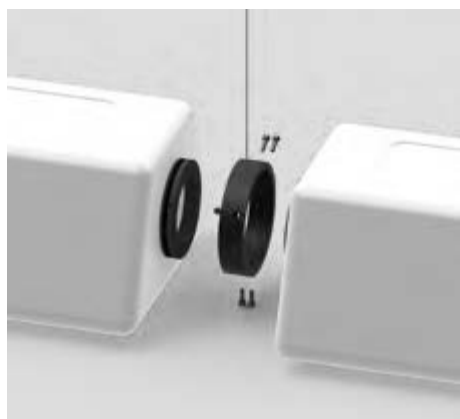

giunto elettrico 5 conduttori
all'interno dei moduli.
electrical joint with 5 conductors inside
the modules.

40834

rosone da fissare al soffitto Ø10 H 3
ceiling rose to be fixed to the ceiling.

40835/BI

cavi di sospensione 500cm
suspension cables



CIRCULAR POL XXL

esempi di composizione / examples of compositions

Esempi di composizione quadrata e circolare formati con l'impiego dei tre moduli base e dei giunti intermedi del sistema. Alimentatori elettronici dimmerabili all'interno dei moduli.

Examples of a square and circular compositions created using the three basic modules and the system intermediate joints. Dimmable electronic drivers inside the modules.



watt	flusso/flux	CCT	Kg	colore/colour	codice/code
CIRCULAR POL XXL 226x226					
4x60W+4x20W 230V	36000lm	3000K	53	○ bianco/white	2057/XXL/Q/DIM/L/1/BI
4 moduli lineari e 4 moduli angolari 90° / 4 linear modules and 4 90° corner modules					

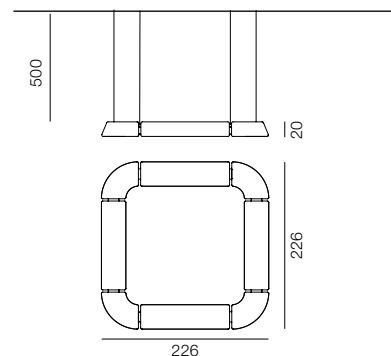

CIRCULAR POL XXL Ø350					
8x60W 230V	54000lm	3000K	69	○ bianco/white	2057/XXL/DIM/L/1/BI
8 moduli curvi 120° / 8 curve modules 120°					

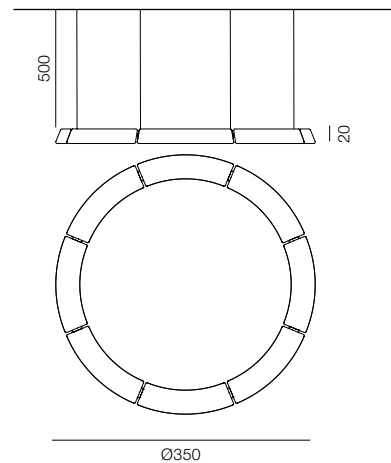

alimentatori elettronici dimmerabili integrati / integrated electronic dimmable drivers





PISTILLO

Un cilindro in metacrilato sospeso con cavi in acciaio emana una luce morbida e diffusa. Posizionato in orizzontale per illuminare un tavolo o verticale per sottolineare un'architettura od un percorso. Da solo o insieme ad altri Pistillo con inclinazioni diverse rende vivo e movimentata lo spazio con dei flash di luce.
Sorgente di luce a LED.

A methacrylate cylinder suspended with steel cables that spreads a soft and diffused light. Placed horizontally in order to light up a table or vertically to emphasize an architecture or a pathway. Alone or together with other Pistillo with several inclines, it brings the space to life and livens it up with light flashes.
LED light source.

Emiliana Martinelli



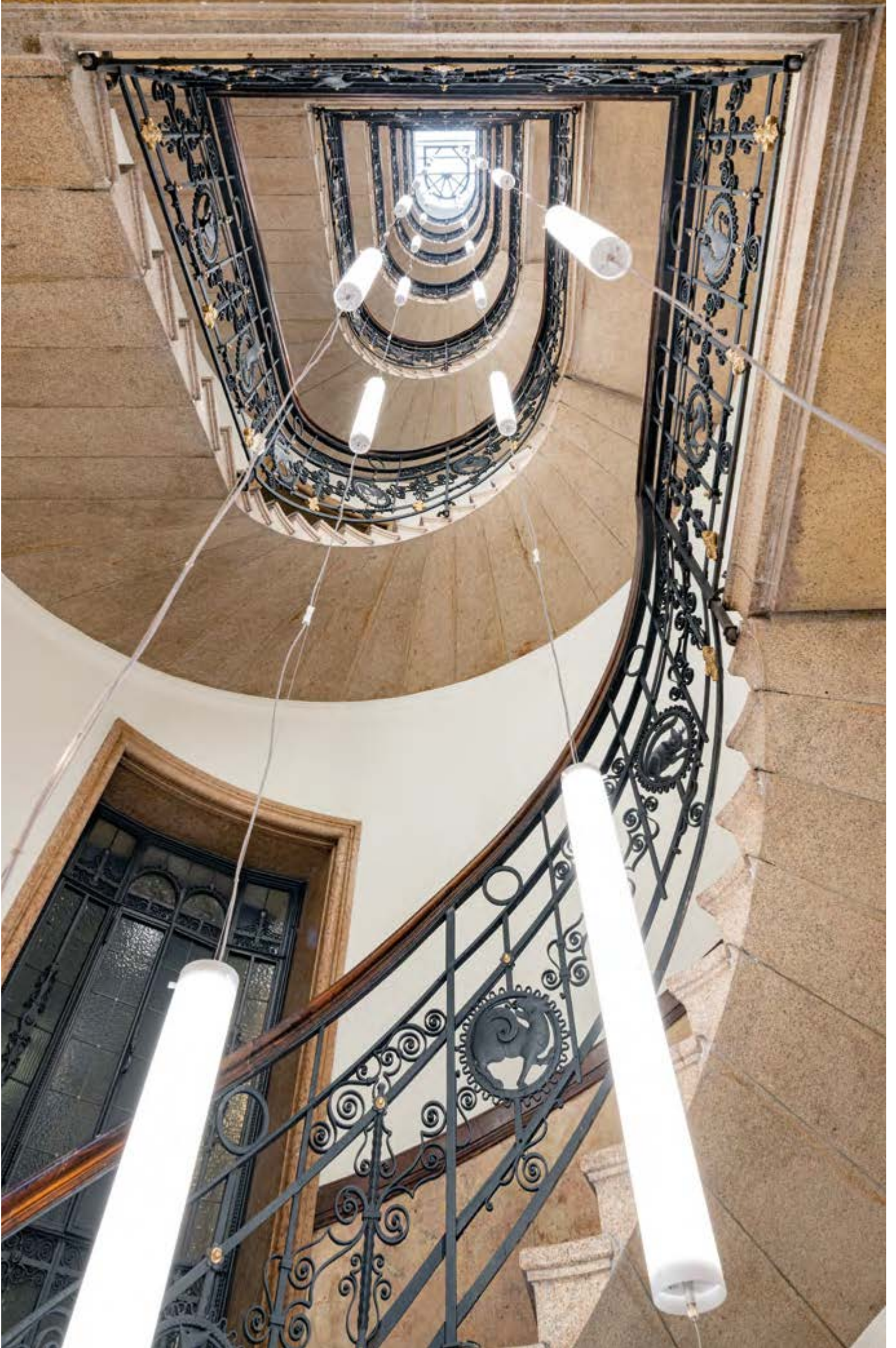



PISTILLO

Lampada a sospensione a luce diffusa, tubo in metacrilato opal bianco, sospeso con 2 cavi o 1 cavo in acciaio (posizione verticale). Completo di alimentatore dimmerabile elettronico integrato nel corpo lampada.

Suspension lamp, diffused light, opal white methacrylate tube, hanged with 2 steel cables or 1 steel cable (vertical position). Dimmable electronic driver included in the body lamp.



watt	flusso/flux	CCT	Kg	colore/colour	codice/code
------	-------------	-----	----	---------------	-------------

PISTILLO LED					
60W 230V	4700lm	3000K	5	○ bianco/white	2063/L/1
non dimmerabile / non dimmable					

60W 230V	4700lm	3000K	5	○ bianco/white	2063/DIM/L/1
dimmerabile / dimmable					

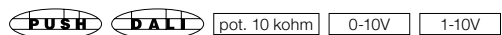

 PISTILLO LED RGB
100W 230V
dimmerabile / dimmable

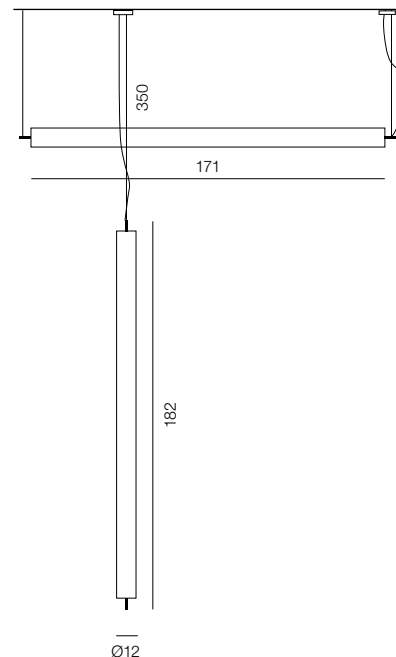

Dispositivi remoti per mod. 2063/L/1 vedi pagina 527
Remote devices for mod. 2063/L/1 see page 527

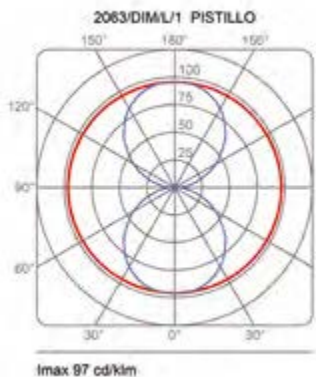



LENT

Una grande lampada sospesa sobria e importante, ma allo stesso tempo sottile ed elegante con i suoi tre colori. Grazie alla sua struttura in materiale fonoassorbente, Lent ti permette di sentire il suono più che il rumore e con la luce centrale di illuminare anche uno spazio.

A large suspended lamp, sober and important but at the same time thin and elegant with its three colours. Thanks to the insulating material it is made with, Lent allows you to hear sounds rather than noise and to illuminate a space with its central light.

Yonoh Creative Studio







LENT

LAMPADA CON SCHERMO DARK-LIGHT / LAMP WITH DARK-LIGHT SCREEN

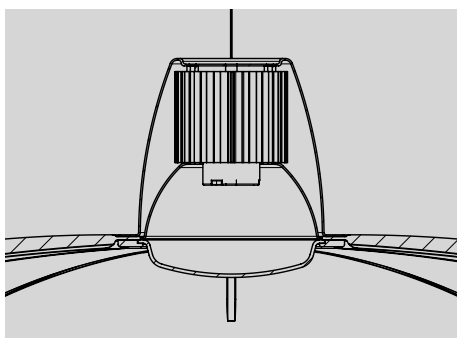

LAMPADA CON DIFFUSORE (A)
LAMP WITH DIFFUSER

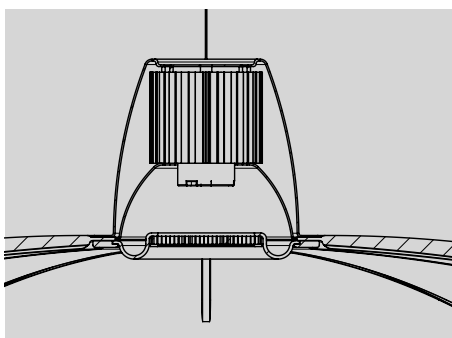

LAMPADA CON SCHERMO DARK-LIGHT (B)
LAMP WITH DARK-LIGHT SCREEN

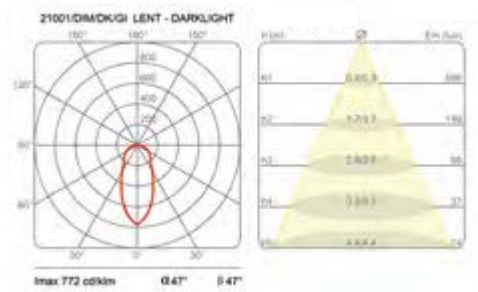
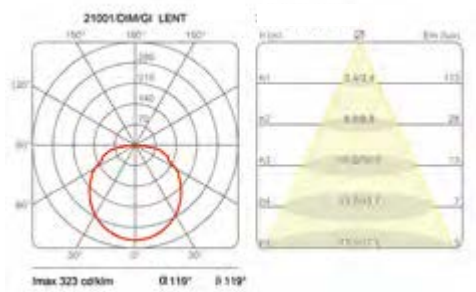



LENT

Lampada a sospensione a luce diretta che sviluppa il tema del comfort acustico tramite un riflettore speciale stampato con materiale fonoassorbente e tessuto, in grado di assorbire le onde acustiche rallentandone il riverbero. Spot centrale con sorgente di luce a LED integrata con dissipatore, nella versione con diffusore in policarbonato o con schermo dark-light. Disponibile in tre colori: grigio, giallo senape e verde muschio. Alimentatore elettronico dimmerabile inserito all'interno del rosone al soffitto.

Hanging lamp, direct light, that develops the theme of acoustic comfort thanks to a special reflector molded with soundproof material and fabric, capable of absorbing sound waves, slowing their reflection. Central spotlight with integrated LED light source and heatsink, in the version with diffuser in polycarbonate or dark-light screen. Available in three colours: grey, mustard yellow and moss green. Dimmable electronic driver integrated inside the ceiling rose.

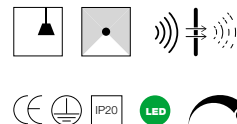

watt	flusso/flux	CCT	Kg	colore/colour	codice/code
------	-------------	-----	----	---------------	-------------

RIFLETTORE FONOASSORBENTE / SOUND-ABSORBING REFLECTOR
con diffusore in policarbonato / with polycarbonate diffuser (A)

17,5W 230V	2200lm	3000K	9	giallo/yellow	21001/DIM/GI
				grigio/grey	21001/DIM/GR
				verde/green	21001/DIM/VE

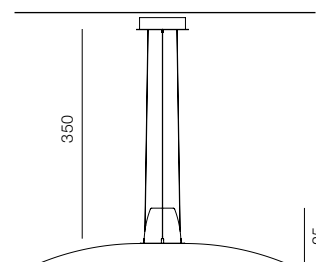

RIFLETTORE FONOASSORBENTE / SOUND-ABSORBING REFLECTOR
con schermo dark-light / with dark-light screen (B) UGR<19



17,5W 230V	2200lm	3000K	9	giallo/yellow	21001/DIM/DK/GI
				grigio/grey	21001/DIM/DK/GR
				verde/green	21001/DIM/DK/VE

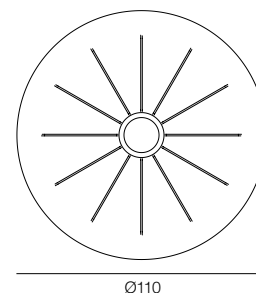

rosone / ceiling rose Ø23 H 5,5
alimentatore elettronico dimmerabile / electronic dimmable driver



RIFLETTORE FONOASSORBENTE SOSPESO / SUSPENDED SOUND-ABSORBING REFLECTOR

3	giallo/yellow	40133/GI
3	grigio/grey	40133/GR
3	verde/green	40133/VE

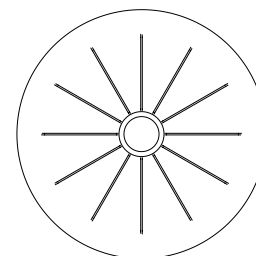
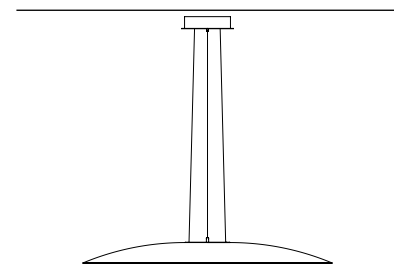



Calcolo dell'assorbimento acustico in camera riverberante secondo la UNI EN ISO 354.
 Volume della camera riverberante: 161,3 m³

Sound absorption calculation in a reverberation room based on the UNI EN ISO 354 norm.
 Reverberation chamber volume: 161,3 m³

f [Hz]	Aobj [m ²]
100	0,12
125	0,26
160	0,19
200	0,56
250	0,65
315	0,81
400	0,98
500	1,03
630	0,98
800	1,12
1000	1,19
1250	1,36
1600	1,43
2000	1,56
2500	1,64
3150	1,71
4000	1,79
5000	1,79

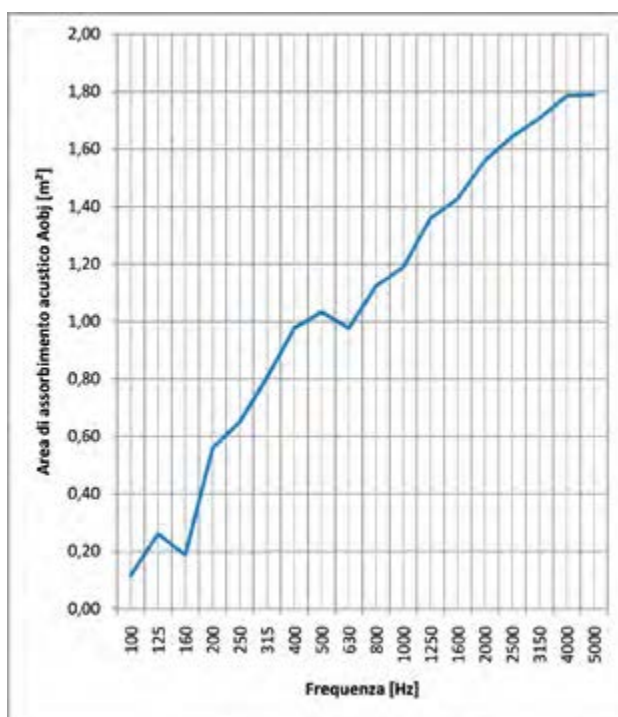

HUSH

Hush è il nuovo sistema light&sound progettato per la qualità della vita negli ambienti di lavoro e negli spazi condivisi. Hush unisce funzionalità e design in un sistema componibile di moduli a sospensione integrati con pannelli fonoassorbenti realizzati con tecnologia SNOWSOUND® (Caimi Brevetti) in vari colori, che rendono Hush perfetto per arredare ogni ambiente.

I pannelli fonoassorbenti permettono di ottenere un assorbimento selettivo alle diverse frequenze (alte, medie, basse) e quindi di ottimizzare l'acustica dell'ambiente.

Hush is the new light&sound system designed to improve the quality of life in working environments and shared spaces in general. Hush combines functionality and design in a suspended modular system integrated with sound-absorbing panels featuring SNOWSOUND® technology (Caimi Brevetti) and available in various colours, making it a perfect decorating choice for any space.

The sound-absorbing panels allow to obtain a selective absorption at different frequencies (high, middle and low) and thus to optimize the acoustics of the space.

Massimo Farinatti













HUSH

pannelli fonoassorbenti / sound-absorbing panels

I suoni sono formati da onde che tendono ad essere riflesse dalle superfici rigide con limitato potere assorbente, quali per esempio il cemento, il marmo o il vetro. In ambienti realizzati con queste tipologie di materiali si possono generare echi e riverberi, spesso molto fastidiosi, che non consentono di ascoltare e dialogare in maniera confortevole. I materiali fonoassorbenti nascono dall'esigenza di migliorare l'acustica in questi ambienti. Le caratteristiche dei prodotti fonoassorbenti tradizionali tendono a manifestare la capacità di assorbire meno le basse frequenze (sotto i 500 Hz), progressivamente di più le medie frequenze (tra i 500 e i 2000 Hz) ed in misura maggiore le alte (sopra i 2000 Hz).

Le tecnologie SNOWSOUND® consentono di ottenere una correzione acustica in modo semplice e rapido, sia in nuovi ambienti che in quelli esistenti. L'esigenza di vivere e lavorare in ambienti meno rumorosi, riducendo il fastidioso riverbero acustico, trova finalmente una risposta in prodotti innovativi adatti a risolvere svariate esigenze.

I pannelli fonoassorbenti realizzati con la pluripremiata tecnologia SNOWSOUND® sono composti da materiale a densità variabile, che permette di ottenere un assorbimento selettivo alle diverse frequenze (alte, medie e basse) e quindi di ottimizzare l'acustica dell'ambiente nonostante lo spessore molto contenuto dei pannelli. I pannelli Snowsound® sono realizzati interamente in poliestere, quindi monomaterici e riciclabili al 100% senza necessità di dover separare il tessuto esterno dal materiale fonoassorbente interno. L'utilizzo di materiali e lavorazioni di alta qualità permettono inoltre di allungare la vita del prodotto con conseguente minor consumo di materiali ed energia. I pannelli non contengono feltri o altri materiali di origine organica difficilmente riciclabili. L'assenza di intercapedini tra tessuto e materiale fonoassorbente e l'assenza di cavità riducono notevolmente la possibilità di accumulare polveri, pollini o di ospitare insetti. Il pannello monomaterico Snowsound nel suo insieme tessuto esterno e materiale fonoassorbente interno, ha Classe 1 Italia di reazione al fuoco ed Euroclass B-s2, d0. I pannelli Snowsound hanno contenuto di formaldeide non rilevabile, test eseguito secondo la norma UNI EN 717-2.

Sounds are formed by waves that tend to be reflected from solid surfaces having limited absorption capacity such as, for example, concrete, marble or glass. In locations made with these types of materials, often very annoying echoes can be created, making it difficult to listen and converse in comfort. Sound absorbing materials are created from the need to improve acoustics in these environments. The sound absorbing characteristics of traditional products tend to demonstrate less capacity to absorb low frequencies (below 500 Hz), progressively more with regard to the midrange (between 500 and 2,000 Hz) and to a greater extent with regard to the high frequencies (above 2,000 Hz).

SNOWSOUND® technologies attain acoustic correction easily and quickly, in new areas as well as in existing spaces. The need to live and work in quiet spaces, reducing the annoying acoustic reverberation, is finally met with these innovative products ideal for resolving a variety of needs.

The sound-absorbing panels created using the multi-award-winning SNOWSOUND® technology are comprised of variable-density material that affords selective absorption of the different frequencies (high, medium, low) and hence allows optimizing the acoustics of the environment despite the panels being very thin. The Snowsound® panels are made in polyester – hence mono-component – and are 100% recyclable without the need to separate the external fabric from the internal sound-absorbing material.

The use of high quality elements also allows extending the life of the product with a consequent lower consumption of materials and energy. The panels do not contain felt or other components of organic origin that are difficult to recycle. The absence of space between the fabric and the sound-absorbing material and the absence of cavities substantially reduce the possibility of the accumulation of dust, pollens or insects. Overall, considering its external fabric and internal sound-absorbing element, the mono-material Snowsound panel is Italian Class 1 as far as reaction to fire, and Euroclass B-s2, d0. Snowsound panels have a negligible formaldehyde content (test carried out pursuant to UNI EN 717-2 standard).



A) 2 Pannelli fonoassorbenti fissati al profilo interno con luce diretta e indiretta.
 A) 2 Sound-absorbing panels fixed to the inner structure with direct and indirect light.

B) Pannello fonoassorbente singolo con attacchi di sospensione.
 B) Single sound-absorbing panel with attachments for hanging cables.

SOUND QUALITY

Il grafico mostra come i pannelli Snowsound incidono sull'acustica di un ambiente:
 The graphic shows how the Snowsound panels affect the acoustics of a room:

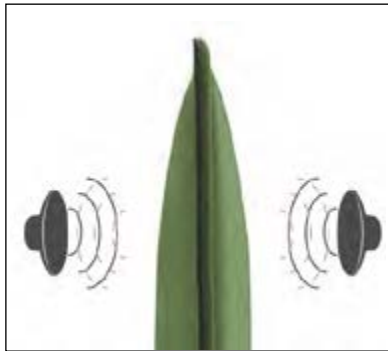

L'assenza di cornici rende le superfici dei pannelli Snowsound completamente fonoassorbenti.

The absence of frames makes the surfaces of the Snowsound panels completely soundproof.

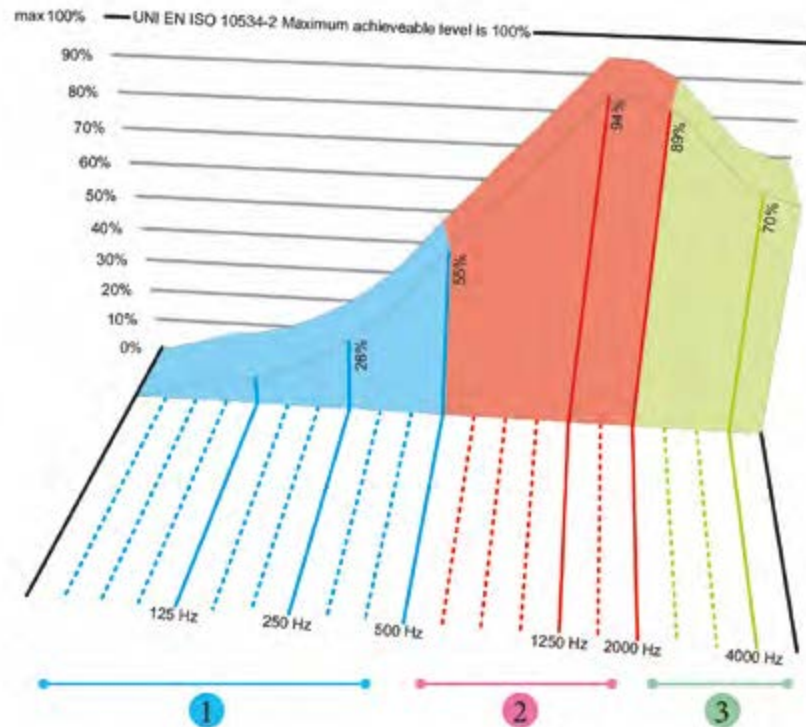

HUSH

sospensione luce diretta-indiretta / suspension direct-indirect light

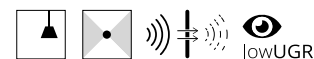

Un sistema formato da moduli componibili fonoassorbenti.

Hush è composto da: un profilo interno in alluminio con sorgente di luce Led diretta e indiretta a cui vengono fissati lateralmente i 2 pannelli fonoassorbenti rivestiti in tessuto di vari colori.

Alimentatore dimmerabile remoto o da inserire all'interno del rosone al soffitto.

Disponibile come modulo singolo a sospensione o unito ad altri moduli tramite giunti e con particolari attacchi nella versione a parete.

UGR<19

A system made up of sound-absorbing modular components.

Hush is composed of: an inner aluminium element for direct and indirect light with LED light source, to which two sound-absorbing side panels covered in different colour fabric are fixed.

Remote dimmable driver or to be placed inside the ceiling rose.

Available as a single hanging module or joined together with other modules through joints and with particular brackets in the wall version.



watt	flusso/flux	CCT	Kg	colore/colour	codice/code
------	-------------	-----	----	---------------	-------------

PROFILO INTERNO / INNER PROFILE (A)

profilo interno (A) a luce diretta e indiretta predisposto per fissare i pannelli fonoassorbenti (B)
inner profile (A) with direct and indirect light arranged to fix sound-absorbing panels (B)

luce diretta / direct light

47W 24V	4620lm	3000K	2,5	● grigio/grey	40074/GR
---------	--------	-------	-----	---------------	----------

+

luce indiretta / indirect light

28W 24V	1944lm	3000K			
---------	--------	-------	--	--	--

testata terminale / terminal head (C)

● grigio/grey	40076
---------------	-------

testata intermedia / intermediate head (E)

● grigio/grey	40075
---------------	-------

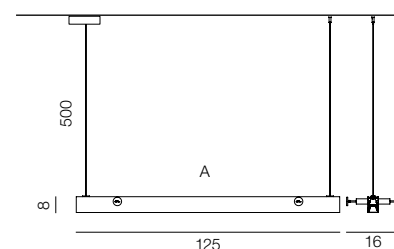

GIUNTI / JOINTS (D)

giunto lineare / linear joint

1	● grigio/grey	40078
---	---------------	-------

giunto 90° / joint 90°

1	● grigio/grey	40077
---	---------------	-------

giunto a T / T-joint

1,5	● grigio/grey	40079
-----	---------------	-------

giunto a croce / cross joint

2	● grigio/grey	40080
---	---------------	-------

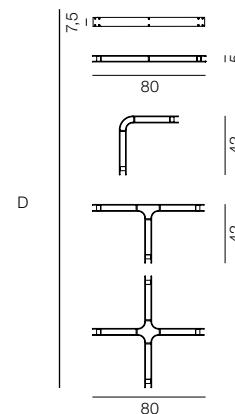

PANNELLO FONOASSORBENTE / SOUND-ABSORBING PANEL (B)

pannello da fissare al profilo interno / panel to be fixed to the inner profile (B)

2,3	○ bianco/white	40112/BI
-----	----------------	----------

	● verde/green	40112/VE
--	---------------	----------



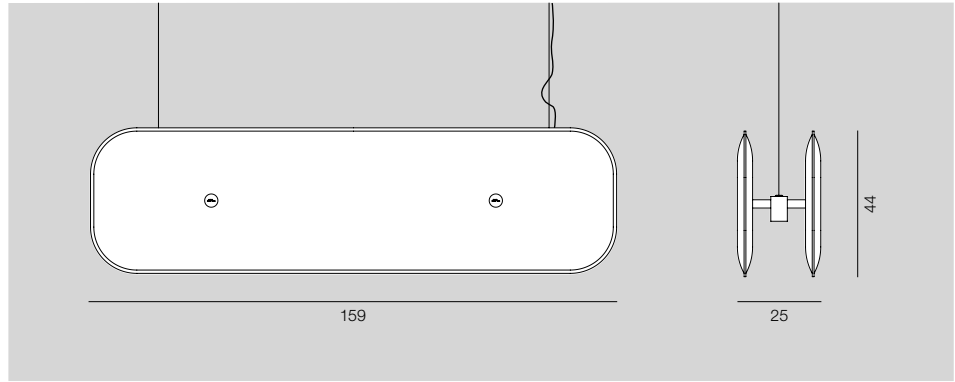

ESEMPI DI COMPOSIZIONE / EXAMPLES OF COMPOSITION

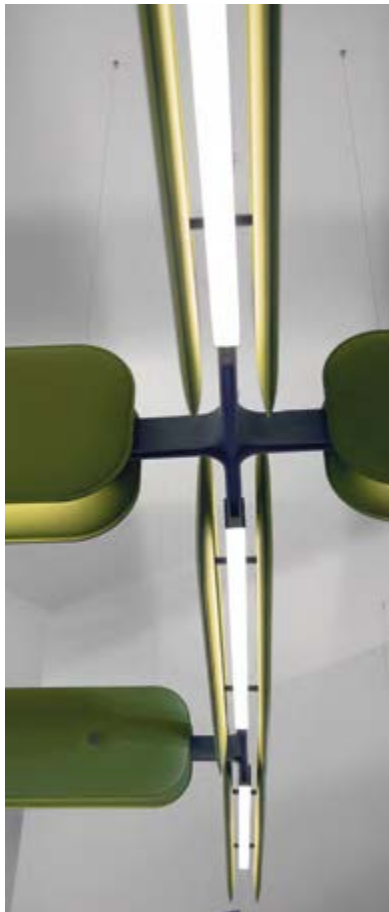

MODULO SINGOLO / SINGLE MODULE:

- (A) 1 profilo interno
1 inner profile
- (B) 2 pannelli fonoassorbenti
2 sound-absorbing panels
- (C) 2 testate terminali
2 terminal heads

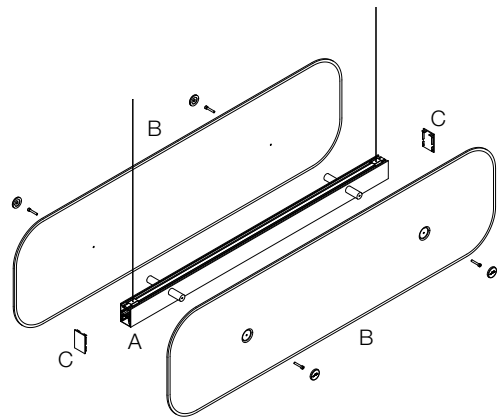

DUE MODULI / TWO MODULES:

- (A) 2 profil interni
2 inner profiles
- (C) 2 testate terminali
2 terminal heads
- (E) 2 testate intermedie
2 intermediate heads
- (D) 1 giunto lineare
1 linear joint
- (B) 4 pannelli fonoassorbenti
4 sound-absorbing panels

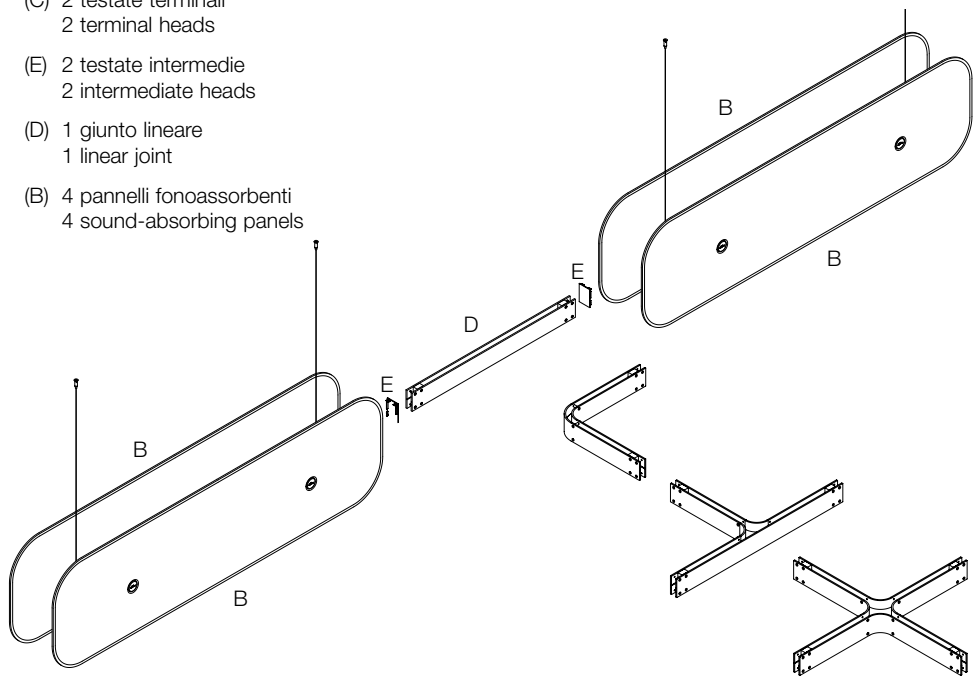

HUSH

rosone /ceiling rose

Rosone completo di alimentatore elettronico dimmerabile e non dimmerabile per la versione a sospensione per singolo modulo o per massimo quattro moduli uniti con i diversi giunti. Sono disponibili dispositivi di controllo da inserire remoto nel rosone per dimmerazione (pag.527).

Complete ceiling rose with dimmable and non-dimmable electronic driver for the suspension for the single module or for up to four modules connected together through joints. Remote control devices are available to insert in the ceiling rose for dimming (page 527).



watt	Kg	codice/code
rosone con alimentatore per 1 modulo singolo non dimmerabile - 35x8 H 5 cm ceiling rose with driver for 1 single non-dimmable module		
75W 230/24V	1,5	40119
rosone con alimentatore per 1 modulo dimmerabile - 35x8 H 5 cm ceiling rose with driver for 1 single dimmable module		
75W 230/24V	1,5	40120
pot. 10 kohm 0-10V 1-10V		

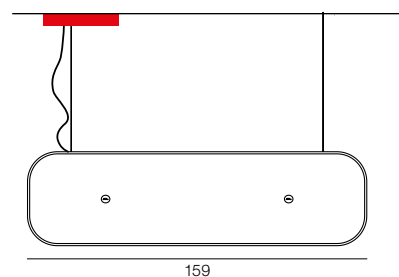

rosone con alimentatore per max 4 moduli non dimmerabili - 60x8 H 5 cm ceiling rose with driver for up to 4 non-dimmable modules		
300W 230/24V	2	40121
rosone con alimentatore per max 4 moduli dimmerabili - 60x8 H 5 cm ceiling rose with driver for up to 4 dimmable modules		
300W 230/24V	2	40122
pot. 10 kohm 0-10V 1-10V		

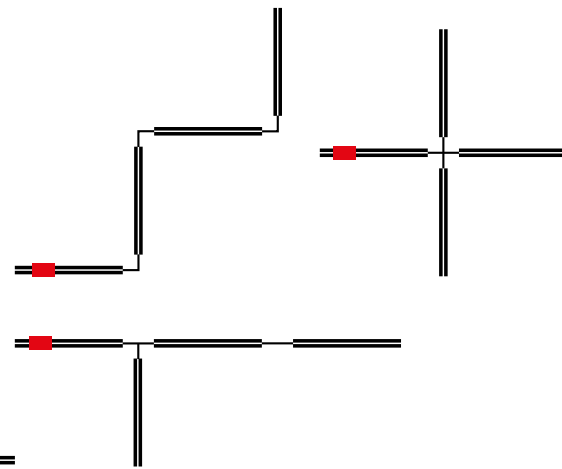

156

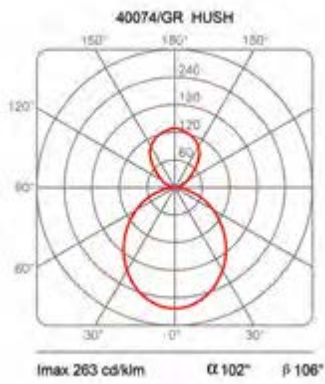



HUSH

parete luce diretta-indiretta / wall direct-indirect light

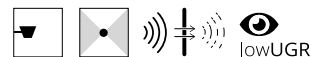

I moduli oltre che a sospensione possono essere fissati con particolari supporti a parete. Il sistema a parete è formato da: un profilo interno in alluminio a luce diretta e indiretta con sorgente di luce LED a cui viene fissato lateralmente 1 pannello fonoassorbente e supporti per attacco a parete. Alimentatore integrato.

In addition to the suspension version, the modules can be fixed to the wall using special supports. The wall system is made of: an inner aluminium structure with direct and indirect light with LED light source to which 1 sound-absorbing panel is fixed laterally, and supports for wall mounting. Integrated driver.

UGR compatibile

compatible UGR



watt	flusso/flux	CCT	Kg	colore/colour	codice/code
------	-------------	-----	----	---------------	-------------

PROFILO INTERNO / INNER PROFILE (A)

profilo interno a luce diretta e indiretta con supporto per fissare il pannello fonoassorbente
inner profile with direct and indirect light arranged to fix sound-absorbing panels

luce diretta / direct light

47W 230V 4620lm 3000K

+

luce indiretta / indirect light

28W 230V 1944lm 3000K 2,5 ● grigio/grey 40074.2/GR

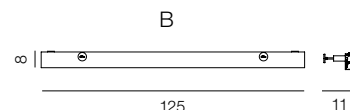

alimentatore elettronico integrato / integrated driver

ATTACCO A PARETE / WALL MOUNTING

testata per supporto parete / head for wall support (E)

0,2 ● grigio/grey 40075



E

kit 2 supporti a parete / 2 wall supports kit (F)

0,2 ● grigio/grey 40132/GR



F

PANNELLO FONOASSORBENTE / SOUND ABSORBING PANEL (B)

pannello da fissare al profilo interno / panel to be fixed to the inner profile

2,3 ○ bianco/white 40112/BI

● verde/green 40112/VE

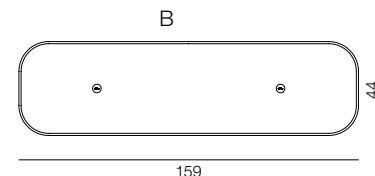

SNOWSOUND© (Caimi Brevetti)

Lampada da parete composta da:

1 profilo interno (A), 1 pannello fonoassorbente (B),
2 attacchi a parete (F) e due testate (E).

Wall lamp composed of:

1 inner profile (A), 1 sound-absorbing panel (B),
2 wall connections (F) and 2 head (E).

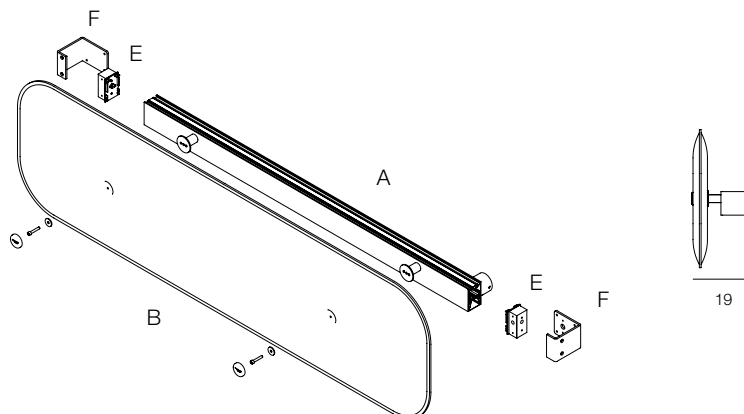



HUSH

pannelli singoli fonoassorbenti / individual sound-absorbing panels

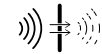

I pannelli fonoassorbenti possono essere sospesi con cavi in acciaio o fissati a parete come moduli singoli tramite supporti.

The sound-absorbing panels can be either suspended with steel cables or fixed to the wall as individual modules with supports.

Kg colore/colour codice/code

PANNELLO A SOSPENSIONE / SUSPENSION PANEL

pannello singolo con attacchi di sospensione / single panel with suspension supports

2,5 ○ bianco/white 40112.1/BI
 ● verde/green 40112.1/VE

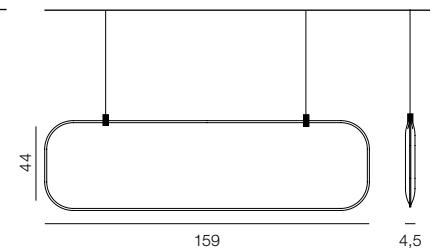

PANNELLO DA PARETE / WALL PANEL

pannello singolo con attacchi per parete / single panel with wall supports

2,5 ○ bianco/white 40112/BI
 ● verde/green 40112/VE

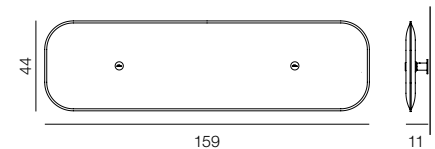

kit attacco a parete / wall support kit Ø5 H 5 ● grigio/grey 40134/GR

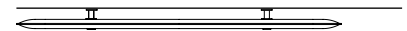



HUSH

profilo sospeso a luce diretta-indiretta / direct-indirect light suspension profile



Solo profilo interno a luce diretta e indiretta a sospensione (senza pannelli fonoassorbenti) da usare dove è necessaria più luce nell'ambiente. Struttura in alluminio estruso verniciato nel colore grigio. Sorgente di luce a LED. Alimentatore dimmerabile remoto o da inserire all'interno del rosone al soffitto. Per il rosone da utilizzare vedi pagina dedicata

Hanging inner profile with direct and indirect light (without sound-absorbing panels) convenient where more light is needed in the room. Extruded aluminium structure painted in grey colour. LED light source. Remote dimmable driver or to be placed inside the ceiling rose. For the ceiling rose to be used, see the dedicated page



Per collegare in linea profilo con profilo o profilo con modulo di collegamento, occorre utilizzare il giunto meccanico 40159.

To connect profile to profile or profile to connection module, both in line, the mechanical joint 40159 must always be used.

watt	flusso/flux	CCT	Kg	colore/colour	codice/code
------	-------------	-----	----	---------------	-------------

PROFILO INTERNO CON LUCE / INNER PROFILE WITH LIGHT

solo profilo da sospendere, senza pannelli fonoassorbenti
hanging profile without sound-absorbing panels

luce diretta / direct light 47W 24V	4620lm	3000K	2,5	● grigio/grey	40074.1/GR
+ luce indiretta / indirect light 28W 24V	1944lm	3000K			

UGR compatibile / UGR compatible

testata terminale / terminal head	● grigio/grey	40076
giunto meccanico / mechanical joint		40159

GIUNTI CON LUCE DIRETTA-INDIRETTA / JOINTS WITH DIRECT-INDIRECT LIGHT

giunto lineare / linear joint

12+7,2W	1170+500lm	3000K	● grigio/grey	40078.1
---------	------------	-------	---------------	---------

giunto 90° / 90° joint

13+8W	1270+560lm	3000K	● grigio/grey	40077.1
-------	------------	-------	---------------	---------

giunto a T / T-joint

17,5+10,8W	1710+750lm	3000K	● grigio/grey	40079.1
------------	------------	-------	---------------	---------

giunto a croce / cross joint

23,5+14,5W	2300+1010lm	3000K	● grigio/grey	40080.1
------------	-------------	-------	---------------	---------

rosoni vedi pagina dedicata / ceiling roses see dedicated page 156

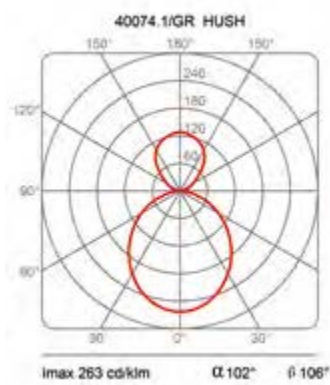
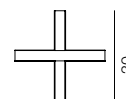
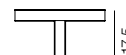
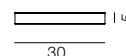
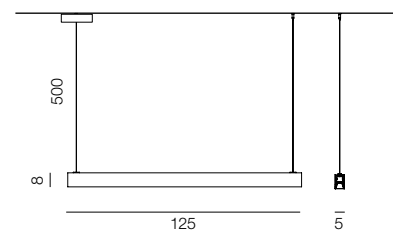

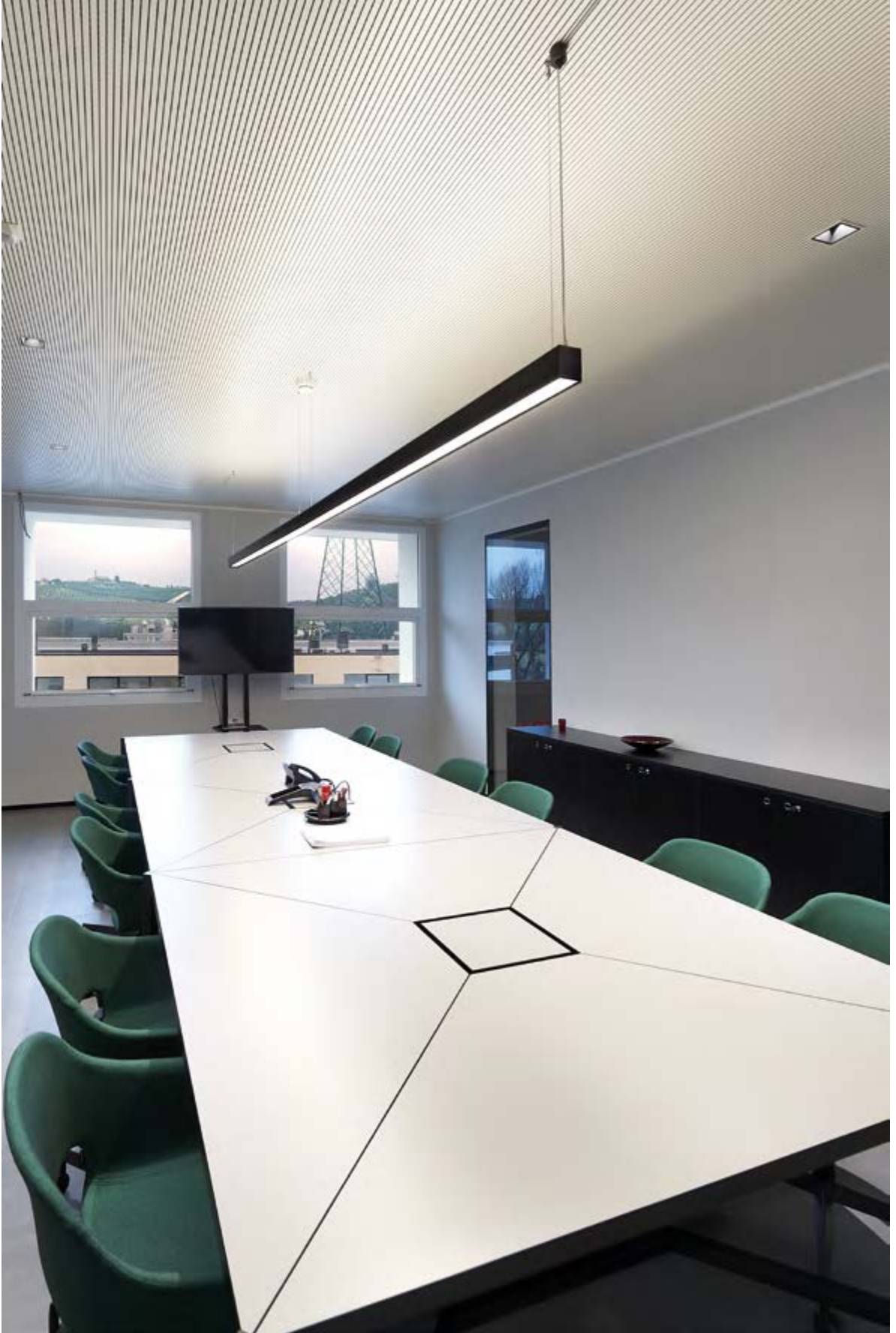

HUSH

profilo interno a parete a luce diretta-indiretta / direct-indirect wall inner profile



Solo profilo interno a luce diretta e indiretta con attacchi per parete (senza pannelli fonoassorbenti) da usare dove è necessaria più luce nell'ambiente. Struttura in alluminio estruso verniciato nel colore grigio. Sorgente di luce a LED. Alimentatore integrato.

Wall inner profile with direct and indirect light (without sound-absorbing panels) convenient where more light is needed in the room. Extruded aluminium structure painted in grey colour. LED light source. Integrated driver.



watt	flusso/flux	CCT	Kg	colore/colour	codice/code
------	-------------	-----	----	---------------	-------------

PROFILO INTERNO CON LUCE / INNER PROFILE WITH LIGHT (H)

solo profilo da parete, senza pannelli fonoassorbenti
wall profile without sound-absorbing panels

luce diretta / direct light 47W 230V	4620lm	3000K	2,5	● grigio/grey	40074.3/GR
+ luce indiretta / indirect light 28W 230V	1944lm	3000K			

alimentatore elettronico integrato / integrated driver

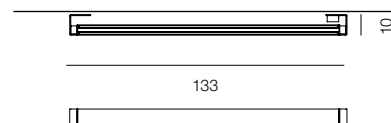

ATTACCO A PARETE / WALL MOUNTING

testata per supporto parete / head for wall support (E)	0,2	● grigio/grey	40075
---	-----	---------------	-------

kit 2 supporti a parete / 2 wall supports kit (F)	0,2	● grigio/grey	40132/GR
---	-----	---------------	----------

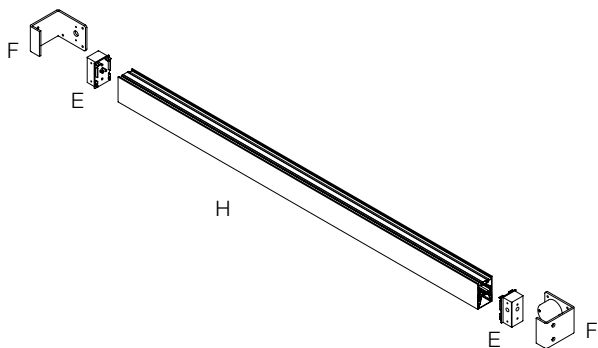



COLIBRÌ

Una famiglia di apparecchi con struttura tubolare di piccole dimensioni che comprende lampade a sospensione, parete, da terra e da tavolo orientabili, a luce diffusa o con spot direzionabili per una luce d'accento.

I diversi giunti di connessione, a magneti, lineare e ad angolo retto, permettono una versatilità a Colibrì, così da poter rispondere alle varie esigenze di illuminazione di ambienti, sia residenziali che professionali.

Le versioni da terra e da tavolo sono presenti nel catalogo lampade.

A family of devices with a small tubular structure that includes pendant, wall, floor and table lamps that can be directed, with diffused light or with directional spots for accent lighting.

The different connection joints, with magnet, linear and at right angles, afford Colibrì versatility, allowing it to respond to the lighting demands for different environments, both residential and professional.

Floor and table versions can be found in the lamp catalogue.

Emiliana Martinelli









COLIBRÌ Q

sospensione 90° / 90° suspension

Sistema componibile a sospensione, composto da moduli lineari, orientabili, di diverse lunghezze. Luce diretta, indiretta e orientabile. Moduli in tubolare di alluminio verniciato, sorgente di luce a LED. Diffusore in policarbonato opal bianco. Il giunto angolare a 90° permette di creare configurazioni di forma quadrata e rettangolare, oltre a poter creare soluzioni libere bidimensionali e tridimensionali. Alimentatore dimmerabile inserito nel rosone da fissare al soffitto o remoto.

Modular suspension light system composed of linear adjustable modules having different lengths. Direct, indirect and adjustable light. Modules in tubular painted aluminium. LED light source, white opal polycarbonate diffuser. The 90° corner joint allows to create square or rectangular configurations, as well as creative two-dimensional and three-dimensional solutions. Dimmable driver placed in the ceiling rose or remotely.

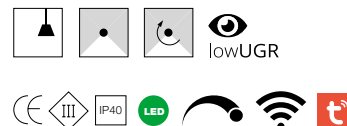

watt	flusso/flux	CCT	Kg	colore/colour	codice/code
------	-------------	-----	----	---------------	-------------

MODULI / MODULES

modulo / module 30

3,5W 24V	580lm	3000K	0,3	● nero/black	40083/NE
----------	-------	-------	-----	--------------	----------

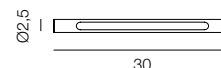

modulo / module 65

7W 24V	1150lm	3000K	0,5	● nero/black	40082/NE
--------	--------	-------	-----	--------------	----------



modulo / module 130

14W 24V	2300lm	3000K	1	● nero/black	40081/NE
---------	--------	-------	---	--------------	----------



MODULI CIECHI DI COLLEGAMENTO / BLIND CONNECTION MODULES

modulo / module 15

modulo senza luce / module without light			0,08	● nero/black	40115/NE
--	--	--	------	--------------	----------

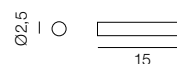

modulo / module 30

modulo senza luce / module without light			0,15	● nero/black	40116/NE
--	--	--	------	--------------	----------

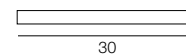

ROSONI / CEILING ROSES

75W 230/24V			1,5	● nero/black	40163/NE
-------------	--	--	-----	--------------	----------

120W 230/24V			1,5	● nero/black	40085/NE
--------------	--	--	-----	--------------	----------

240W 230/24V			2,5	● nero/black	40102/NE
--------------	--	--	-----	--------------	----------

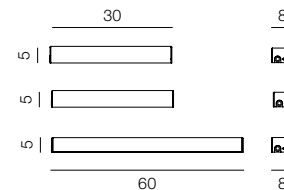

passacavo a membrana per il passaggio di più cavi di alimentazione.
membrane cable gland for multiple power cables.

Dispositivi remoti per la dimmerazione vedi pagina 527
Remote dimming devices see page 527

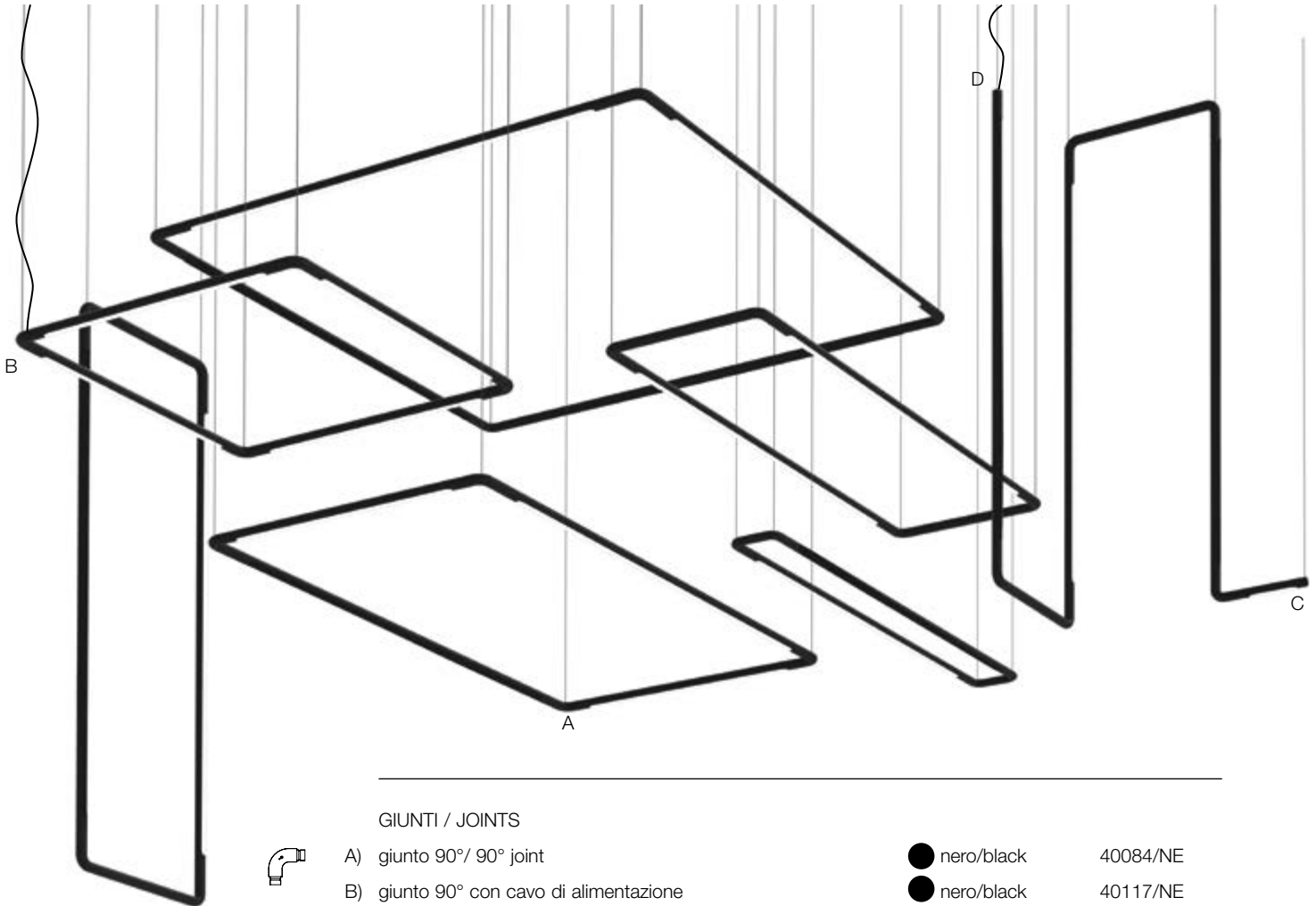

GIUNTI / JOINTS



A) giunto 90° / 90° joint



B) giunto 90° con cavo di alimentazione
90° joint with electrical cable



C) testata terminale / terminal joint

D) testata terminale con cavo di alimentazione
terminal joint with electrical cable

● nero/black

40084/NE

● nero/black

40117/NE

● nero/black

40130/NE

● nero/black

40129/NE

● nero/black

40101/NE

● nero/black

40118/NE

cavo di alimentazione / power cable H 350

MODULO / MODULE 130

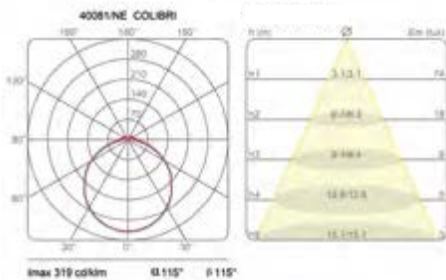

MODULO / MODULE 65

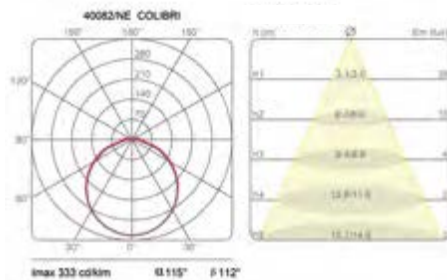

MODULO / MODULE 30



COLIBRÌ Q composizione singola e doppia

sospensione / suspension



Modulo lineare a sospensione. Luce diretta, indiretta e orientabile. Modulo in tubolare di alluminio verniciato, sorgente di luce a LED. Diffusore in policarbonato opal bianco. Giunti e testate per composizione singola o doppia. Alimentatore dimmerabile inserito nel rosone da fissare al soffitto per modulo singolo e doppio.

Suspended linear module. Direct, indirect and adjustable light. Painted tubular aluminium module, LED light source. White opal polycarbonate diffuser. Joints and heads for single and double composition. Dimmable driver placed in the ceiling rose for single and double module.



watt	flusso/flux	CCT	Kg	colore/colour	codice/code
------	-------------	-----	----	---------------	-------------

modulo / module 130 (T)

14W 24V	2300lm	3000K	1	● nero/black	40081/NE
---------	--------	-------	---	--------------	----------

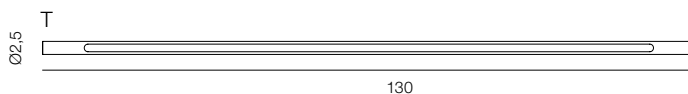

ROSONE / CEILING ROSE

75W 230/24V

1

● nero/black

40114/NE

Dispositivi remoti per la dimmerazione vedi pagina 527
Remote dimming devices see page 527

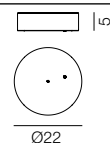

GIUNTI / JOINTS

testata terminale con cavo di alimentazione
terminal joint with electrical cable

● nero/black

40118/NE

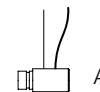

testata terminale / terminal joint

● nero/black

40101/NE

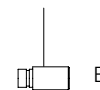

giunto lineare intermedio con cavo di alimentazione
linear intermediate joint with electrical cable

● nero/black

40129/NE

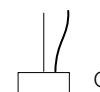

giunto lineare intermedio senza cavo
linear intermediate joint without cable

● nero/black

40130/NE

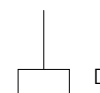

cavo di alimentazione / power cable H 350

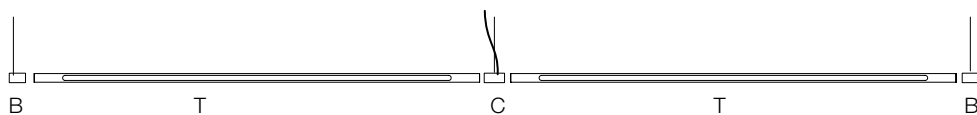
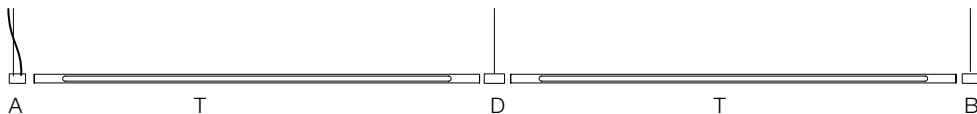
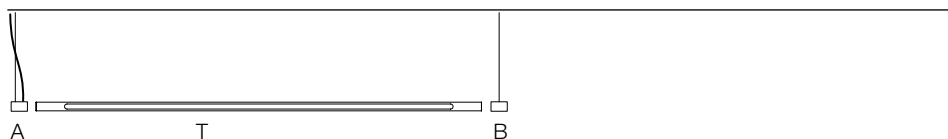



COLIBRÌ Q

parete-soffitto 90° / 90° wall-ceiling



Sistema componibile a parete, composto da moduli lineari, orientabili, di diverse lunghezze. Luce diretta, indiretta e orientabile. Moduli in tubolare di alluminio verniciato, sorgente di luce a LED. Diffusore in policarbonato opal bianco. Il giunto angolare a 90° permette di creare configurazioni di forma quadrata e rettangolare. Giunti per il fissaggio a parete. Alimentatore dimmerabile remoto.

Modular suspension light system composed of linear adjustable modules having different lengths. Direct, indirect and adjustable light. Modules in tubular painted aluminium. LED light source, white opal polycarbonate diffuser. The 90° corner joint allows to create square or rectangular configurations. Joints for wall mounting. Remote dimmable driver.



watt	flusso/flux	CCT	Kg	colore/colour	codice/code
------	-------------	-----	----	---------------	-------------

MODULI / MODULES

modulo / module 30

3,5W 24V	580lm	3000K	0,3	● nero/black	40083/NE
----------	-------	-------	-----	--------------	----------

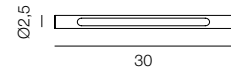

modulo / module 65

7W 24V	1150lm	3000K	0,5	● nero/black	40082/NE
--------	--------	-------	-----	--------------	----------

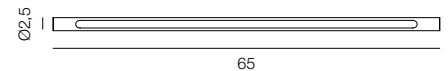

modulo / module 130

14W 24V	2300lm	3000K	1	● nero/black	40081/NE
---------	--------	-------	---	--------------	----------



GIUNTI / JOINTS

giunto 90° / 90° joint	● nero/black	40084/NE
------------------------	--------------	----------



giunto 90° con cavo di alimentazione 90° joint with electrical cable	● nero/black	40117/NE
---	--------------	----------

attacco a parete / wall support Ø3,5 L7	● nero/black	40161/NE
---	--------------	----------



attacco a parete / wall support Ø3,5 L11	● nero/black	40162/NE
--	--------------	----------



ALIMENTATORE REMOTO / REMOTE DRIVER

75W 230/24V	1,5	● nero/black	40163/NE
-------------	-----	--------------	----------

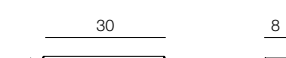

120W 230/24V	1,5	● nero/black	40085/NE
--------------	-----	--------------	----------



240W 230/24V	2,5	● nero/black	40102/NE
--------------	-----	--------------	----------

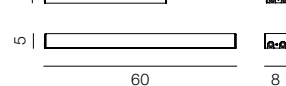

passacavo a membrana per il passaggio di più cavi di alimentazione.
membrane cable gland for multiple power cables.











Showroom Nike – Dubai

COLIBRÌ M

magnetico a sospensione e parete / magnetic suspension-wall

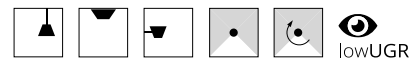

Sistema a moduli tubolari componibili e orientabili per sorgente di luce a LED 24V. In alluminio verniciato nero o anodizzato nel colore bronzo.

Un giunto sferico a magnete permette al Colibrì di assumere diverse angolazioni, in modo da creare varie configurazioni nello spazio e sulla parete. I colibrì sono sospesi o fissati a parete/soffitto come modulo singolo o uniti tra loro con il cavo di alimentazione (foto1) a 1/2/3 moduli continui, da collegare poi all'alimentatore inserito all'interno del rosone o remoto con cavo e spina (foto2).

Modular system with adjustable tubular modules, for 24V LED light source. In black painted aluminium or anodised in the bronze colour. A spherical magnetic joint allows Colibrì to be tilted at different angles, creating various configurations in the space it is placed in and on the wall.

Colibrì can be suspended or fixed to the wall/ceiling as single module or joined through a power cable (picture1) having 1/2/3 continuous modules. These can then be connected to the driver placed inside the ceiling rose or remote or with cable and plug (picture2).



watt	flusso/flux	CCT	Kg	colore/colour	codice/code
1 MODULO / MODULE					
1x14W 24V	1x2300lm	3000K	1,5	● nero/black ● bronzo/bronze	2080/1/NE 2080/1/BZ
2 MODULI / MODULES					
2x14W 24V	2x2300lm	3000K	3,1	● nero/black ● bronzo/bronze	2080/2/NE 2080/2/BZ
3 MODULI / MODULES					
3x14W 24V	3x2300lm	3000K	4,6	● nero/black ● bronzo/bronze	2080/3/NE 2080/3/BZ



magnete sferico / spherical magnet Ø2,6	0,07				30836
pellicola radiant / radiant film	0,1			● multicolor	40072

attacco a parete / wall support Ø2,5 H4				● nero/black ● bronzo/bronze	40123/NE 40123/BZ
attacco a parete / wall support Ø2,5 H8				● nero/black ● bronzo/bronze	40123.1/NE 40123.1//BZ



ROSONE con alimentatore max 3 moduli / CEILING ROSE with driver up to 3 modules					CE, IP40
75W 230/24V	1			● nero/black ● bronzo/bronze	40114/NE 40114/BZ

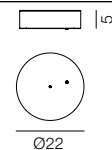

Dispositivi remoti per la dimmerazione vedi pagina 526 / Remote dimming devices see page 527

kit alimentatore a spina / driver and plug kit					40167/NE
--	--	--	--	--	----------

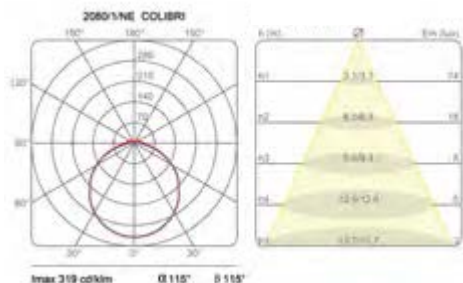

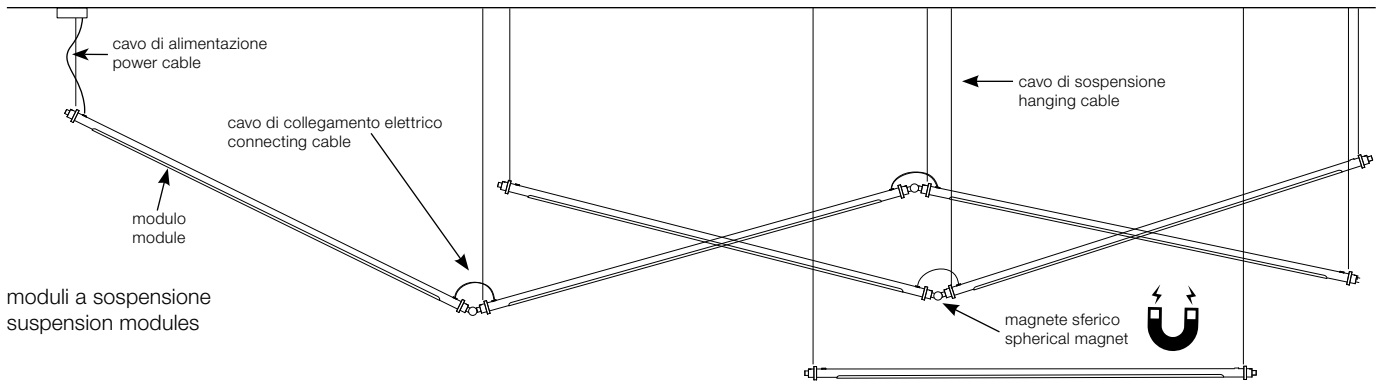
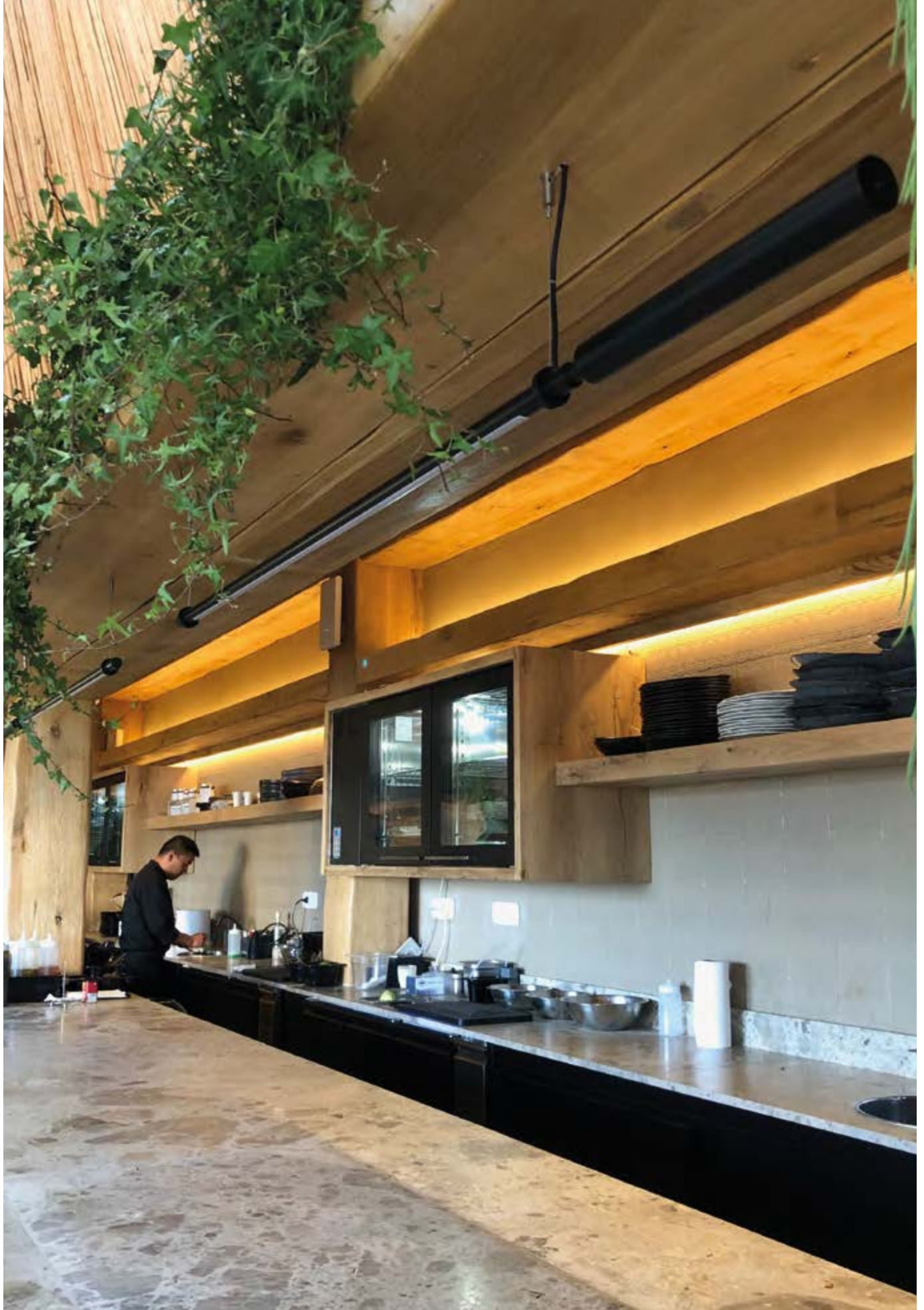

photo 2

Esempio di composizione mista con rosone e cavo di sospensione o con terminale con cavo e spina. Attacchi a parete di due altezze e magnete a sfera.

Example of mixed composition with ceiling rose and suspension cable or with terminal with cable and plug. Wall connections of two heights and ball magnet.





COLIBRÌ AT

sospensione con alimentatore integrato / suspension with integrated driver



Lampada a sospensione a luce diretta/indiretta orientabile. Struttura in alluminio verniciato nel colore nero.

Sorgente di luce a LED integrata. Alimentatore elettronico integrato nel corpo cilindrico fissato alla estremità della lampada.

Adjustable hanging lamp, direct/indirect light. Black painted aluminium structure.

Integrated LED light source. Electronic driver integrated in the cylindrical body fixed to the end of the lamp.



watt	flusso/flux	CCT	Kg	colore/colour	codice/code
14W 230V	2300lm	3000K	1,8	● nero/black	2087/NE

alimentatore elettronico integrato / integrated electronic driver integrated

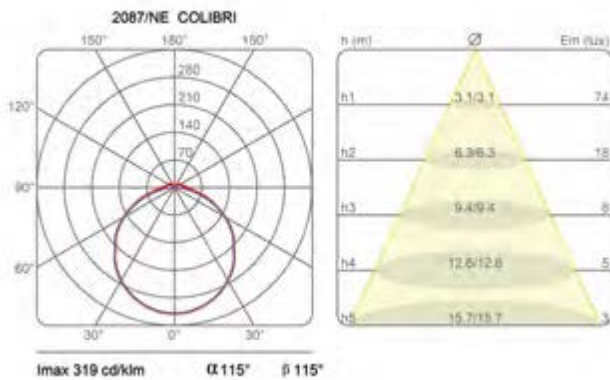
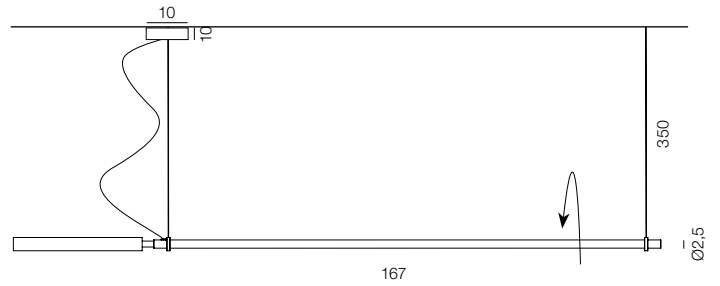



COLIBRÌ AT

parete con alimentatore integrato / wall with integrated driver

Lampada da parete a luce diretta/indiretta orientabile. Struttura in alluminio verniciato nel colore nero.
Sorgente di luce a LED integrata. Alimentatore elettronico integrato nel corpo cilindrico alla estremità della lampada.
Attacco diretto alla rete elettrica.

Wall lamp, adjustable direct/indirect light. Black painted aluminium structure. Integrated LED light source. Electronic driver integrated in the cylindrical body fixed to the end of the lamp. Direct connection to the power grid.



watt	flusso/flux	CCT	Kg	colore/colour	codice/code
14W 230V	2300lm	3000K	1,2	● nero/black	1421/NE

alimentatore elettronico integrato / integrated electronic driver integrated

disponibile su richiesta anche con cavo e spina / also available on request with cable and plug.

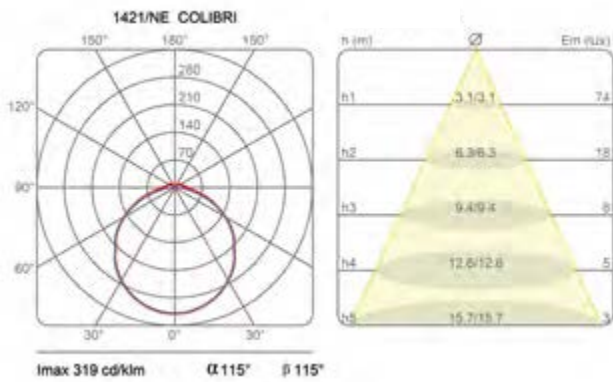
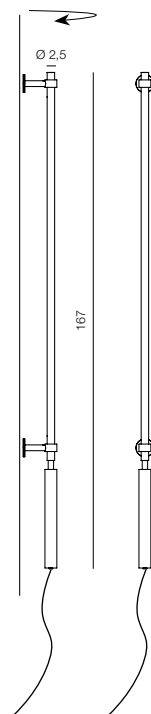
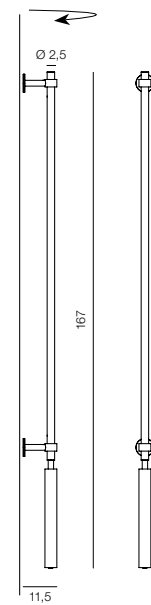







COLIBRÌ S

spot sospensione / suspension spot

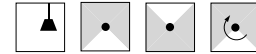

Apparecchio a sospensione a luce diretta/indiretta. Struttura in tubolare in alluminio verniciato, composto da 6 moduli girevoli con spots orientabili e direzionabili indipendentemente. Sorgente di luce a LED integrata, alimentatore incluso nel rosone a soffitto.

Hanging device with direct/indirect light, painted aluminium tubular structure, composed of 6 rotating modules, with small independently adjustable and directable spots. Integrated LED light source, driver included in the ceiling rose.

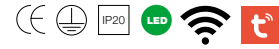

watt	fascio/beam	flusso/flux	CCT	Kg	colore/colour	codice/code
6x3W 230V	narrow	1500lm	3000K	1,2	● nero/black	2070/NE

Dispositivi remoti per la dimmerazione vedi pagina 527 / Remote dimming devices see page 527

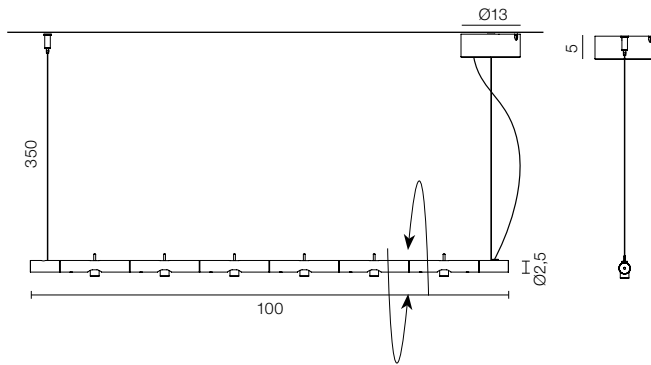

curva relativa a un singolo spot / single spot lighting curve

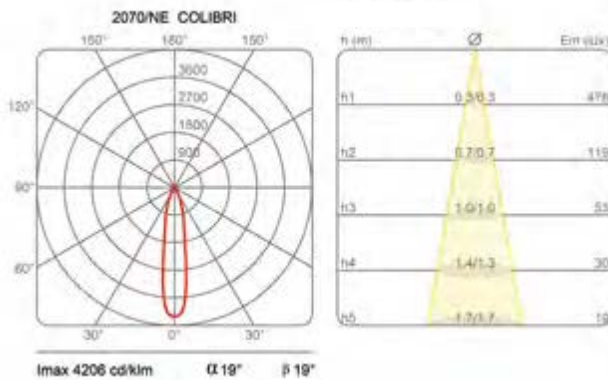



COLIBRÌ S

spot a parete-soffitto / wall-ceiling spot

Apparecchio di piccole dimensioni adatto per un'illuminazione museale, da fissare a parete o all'interno di una bacheca, girevole, a luce diretta/indiretta, con testa orientabile. Struttura in tubolare di alluminio verniciato. Sorgente di luce a LED integrata. Alimentatore elettronico remoto escluso.

Small device suitable for museum lighting, to be fixed to the wall or inside a showcase, swivelling, direct/indirect light, with adjustable head. Tubular painted aluminium structure. Integrated LED light source. Remote electronic driver not included.



watt	fascio/beam	flusso/flux	CCT	Kg	colore/colour	codice/code
3W 500mA	narrow	250lm	3000K	0,2	● nero/black	1406/NE
alimentatore elettronico remoto / remote electronic driver						
25W 230V/500mA						30811.1

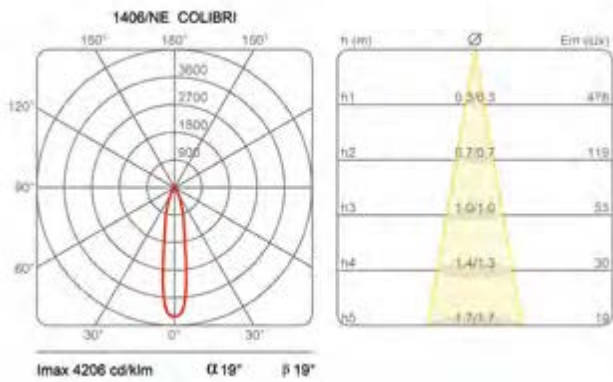
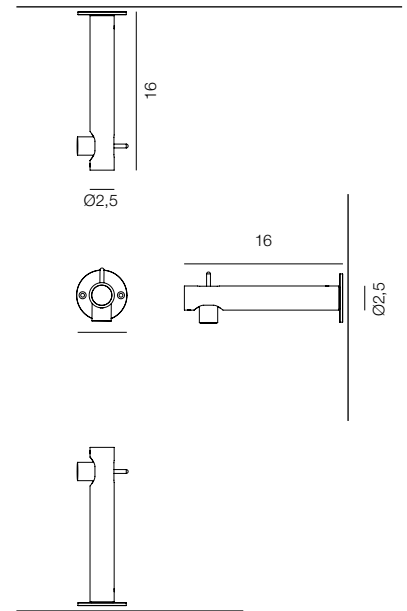



Mostra Hermès, Mito e Bellezza, Palazzo Ducale, Lucca – Napoleone ed Emile Maurice Hermès





COLIBRÌ D

parete a doppia luce / double light wall

Apparecchio da parete a luce diretta/ indiretta, orientabile e girevole, con rotazione indipendente dei due bracci laterali. Con base completa di alimentatore elettronico. Struttura in tubolare di alluminio verniciato. Sorgenti di luce a LED integrate. Colibrì senza base e con alimentatore remoto, su richiesta (vedi foto precedente).

Wall device, direct/indirect adjustable and adjustable light, with independent rotation of the two side arms. Base complete of electronic driver. Tubular painted aluminium structure. Integrated LED light sources. Colibrì without base and with remote driver, on request (see photo previous page).



watt	flusso/flux	CCT	Kg	colore/colour	codice/code
2x10W 230V	2x1032lm	3000K	1,2	● nero/black	1410/B/NE
				● oro p./p. gold	1410/B/AU

alimentatore elettronico 25W integrato nella base / 25W electronic driver integrated in the base

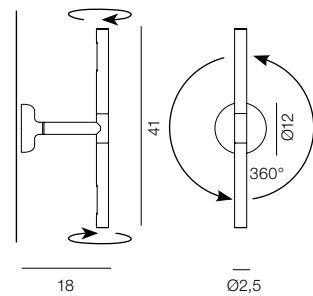

curva relativa a un singolo spot / single spot lighting curve

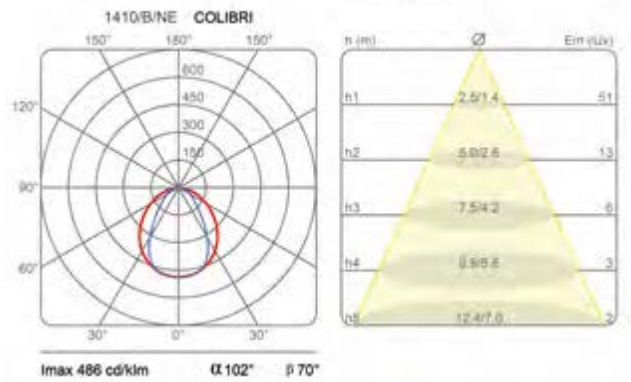



COLIBRÌ Cono

sospensione / suspension

Lampada a sospensione a luce diretta.
 Struttura in alluminio verniciato nei colori
 nero, bianco o giallo.
 Sorgente di luce a LED integrata.
 Alimentatore nel rosone al soffitto.

Suspension lamp with direct light .
 Structure in aluminium painted in black, white
 or yellow colours.
 Integrated LED light source.
 Driver in the ceiling rose.

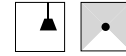

watt	fascio/beam	flusso/flux	CCT	Kg	colore/colour	codice/code
6,5W 230V	medium	630lm	3000K	0,5	● nero/black	21015/NE
					○ bianco/white	21015/BI
					● giallo/yellow	21015/GI

su richiesta fascio narrow o wide / narrow or wide beam on request

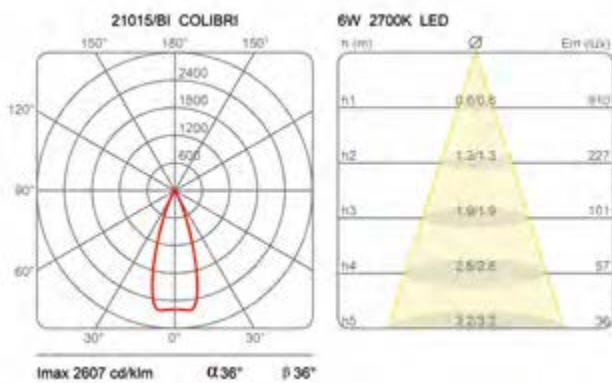
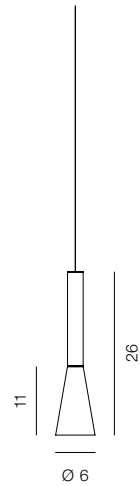



COLIBRÌ Cono

terra / floor

Una lampada da terra da lettura a luce diretta orientabile. Un semplice faretto conico, orientabile, fissato sull'asta verticale tramite un giunto, che permette la rotazione e l'orientabilità, per dirigere la luce verso il basso per una buona lettura o per illuminare verso l'alto il soffitto o un particolare di un quadro. Struttura tubolare in alluminio verniciato nel colore bianco, nero o giallo. Sorgente di luce a LED. Con dimmerazione touch sull'asta. Alimentatore elettronico a spina.

A reading floor lamp with direct adjustable light. A simple conical, adjustable spotlight, fixed to the vertical rod by means of a joint, which allows rotation and swivelling, to direct the light downwards for good reading or to illuminate upwards the ceiling or a detail of a painting. Tubular aluminium structure painted in white, black or yellow. LED light source. With touch dimming on the rod. Electronic plug-in driver.

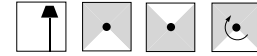

watt	fascio/beam	flusso/flux	CCT	Kg	colore/colour	codice/code
6,5W 230V	medium	630lm	3000K	4,6	○ bianco/white	2312/BI
					● nero/black	2312/NE
					● giallo/yellow	2312/GI

su richiesta fascio narrow o wide / narrow or wide beam on request

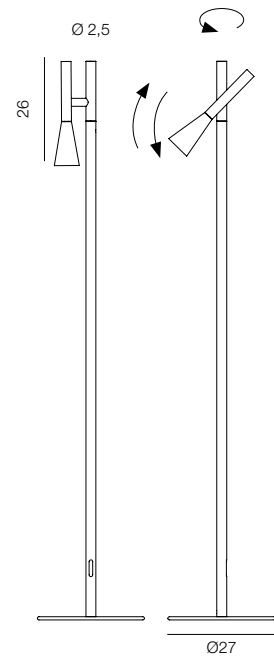

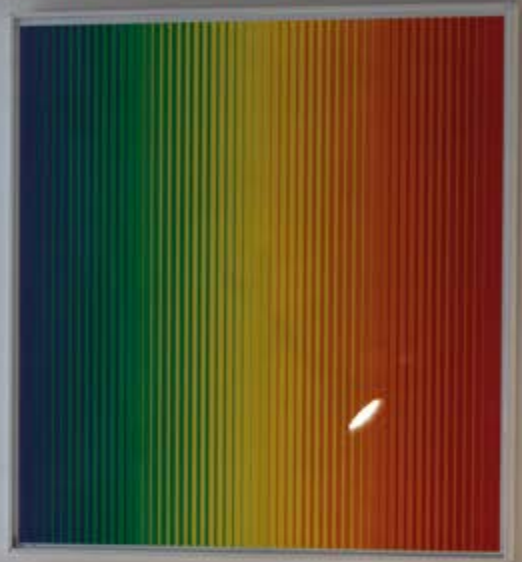

COLIBRÌ S

terra / floor

Lampada da terra con spots a luce diretta orientabili. Struttura tubolare in alluminio verniciato nel colore nero, con quattro teste snodate, girevoli e indipendenti, così da illuminare soggetti da diverse angolazioni. Sorgente di luce a LED. Alimentatore elettronico a spina.

Floor lamp with adjustable direct-light spots. Tubular structure in black painted aluminium with four jointed heads swivelling and independent, to light object at different angles. LED light source. Electronic driver on the plug.

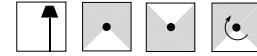

watt	fascio/beam	flusso/flux	CCT	Kg	colore/colour	codice/code
4x3W	medium	4x300lm	3000K	5	● nero/black	2278/NE

su richiesta fascio narrow o wide / narrow or wide beam on request

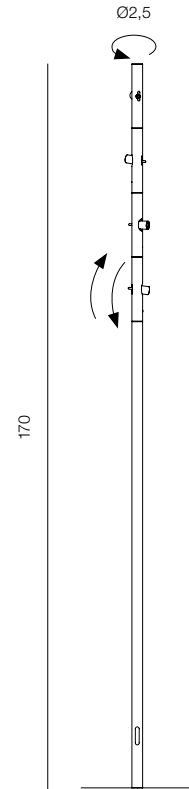

202

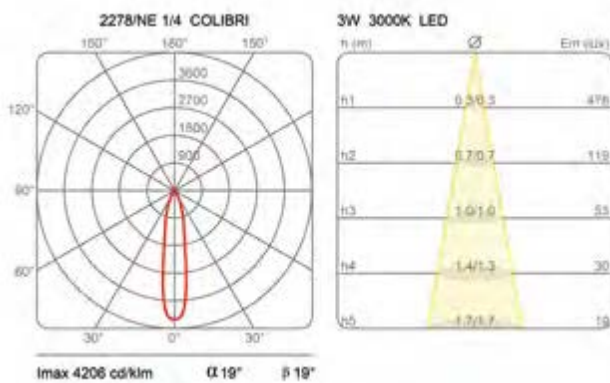



COLIBRÌ AT

terra / floor

Lampada da terra a luce indiretta.
Struttura in tubolare di alluminio, finiture oro o nero.
Diffusore in policarbonato.
Sorgente di luce a LED. Alimentatore elettronico integrato nel corpo cilindrico fissato sulla struttura della lampada.

Floor lamp indirect light.
Tubular aluminium structure, gold or black finishes.
Polycarbonate diffuser.
LED light source. Electronic driver integrated in the cylindrical body fixed on the structure of the lamp.



watt	fascio/beam	flusso/flux	CCT	Kg	colore/colour	codice/code
14W		2300lm	3000K	5	● nero/black ● dorato/golden	2290/NE 2290/AU

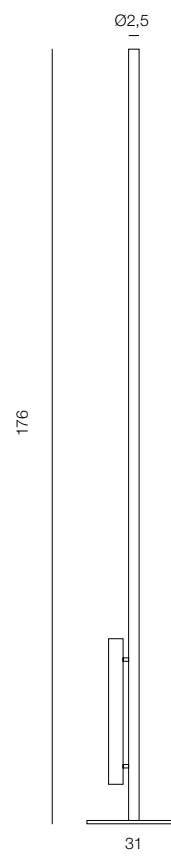



COLIBRÌ tripode | Emiliana martinelli, Marco Pisati

terra / floor

Lampada da terra treppiedi a luce orientabile diretta/indiretta, con rotazione indipendente dei due bracci laterali.

Struttura in tubolare di alluminio verniciato.

Sorgenti di luce a LED integrate.

Alimentatore elettronico a spina.

Tripod floor lamp providing direct/indirect light, adjustable, with independent rotation of the two side arms.

Tubular painted aluminium structure.

Integrated LED light sources.

Electronic driver on plug.

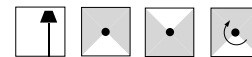

watt	flusso/flux	CCT	Kg	colore/colour	codice/code
2x10W	2x1115lm	2700K		● nero/black	2320/NE
				● giallo/yellow	2320/GI

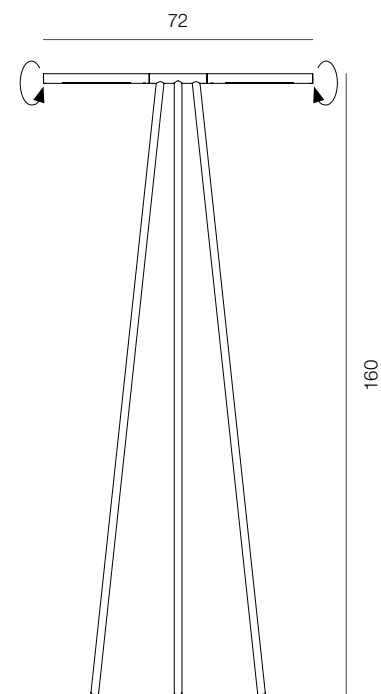



COLIBRÌ T

tavolo / table

Lampada da tavolo a luce diretta orientabile.
Struttura in alluminio verniciato nel colore nero.
Testa girevole per sorgente di luce a LED,
accensione e spegnimento con sensore touch.
Base in metallo verniciato nello stesso colore
del braccio.
Alimentatore elettronico a spina.

Adjustable table lamp direct light.
Black painted aluminium structure.
Swivel head whit LED light source, switching on
and off with touch sensor.
Base painted in the same colour of the arm.
Electronic driver on the plug.



watt	flusso/flux	CCT	Kg	colore/colour	codice/code
10W	800lm	3000K	2,5	● nero/black	811/T/H/NE

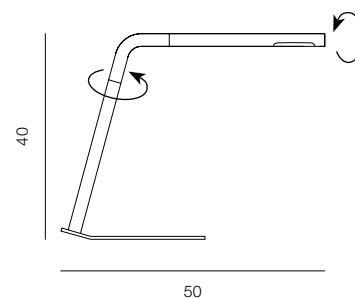



CALABRONE

Una serie di apparecchi disponibili nelle versioni a sospensione, da parete, soffitto e da terra.

Un profilo in tubolare di alluminio con spots direzionabili per una luce d'accento o per una luce orientabile diffusa.

Lenti intercambiabili, per ottenere diverse angolazioni del fascio di luce.

A series of light fixtures available in the suspension, wall, ceiling and floor versions.

An aluminium tubular structure with adjustable spotlights, for an accentuated light or for diffused light.

Interchangeable lenses, in order to obtain different angles of the light beam.

Emiliana Martinelli

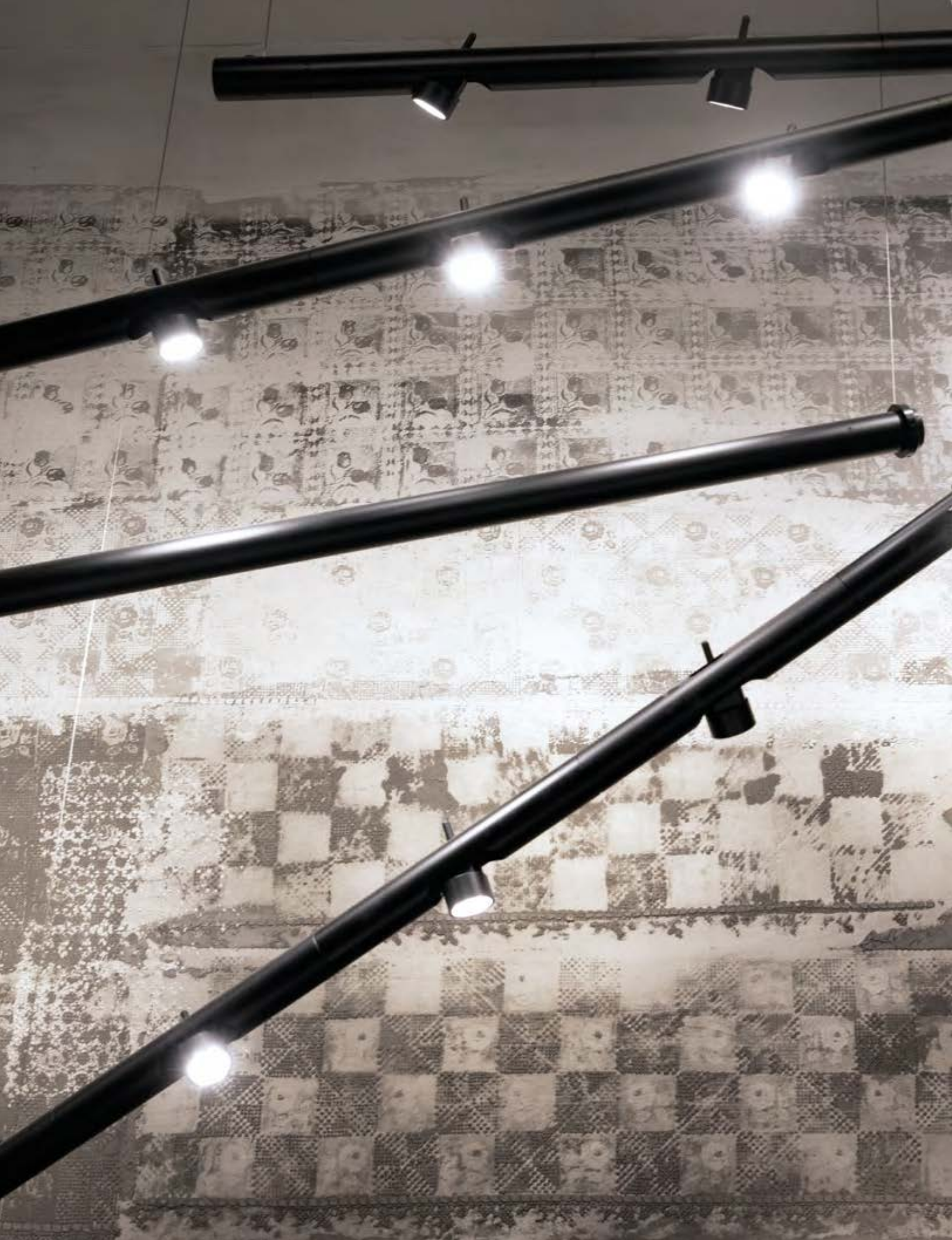





CALABRONE S

spot sospensione / suspension spot

Lampada a sospensione a luce diretta, indiretta e orientabile, formata da moduli in tubolare di alluminio girevoli, con 4/8 spots direzionabili e indipendenti, per sorgente di luce a LED. Disponibili lenti con diverse angolazioni del fascio di luce. Struttura in alluminio verniciato nero. Disponibile un giunto lineare che consente di unire insieme due Calabrone. Alimentatori elettronici dimmerabili inseriti nel rosone al soffitto.

Suspension lamp, direct, indirect and adjustable light, comprised of rotating tubular aluminium modules, with 4/8 adjustable and independent spotlights for LED light source. Available lenses with different angles of the light beam. Black painted aluminium structure. A linear joint is available to join two Calabrone lamps together. Electronic dimmable drivers placed inside the ceiling rose.



watt	fascio/beam	flusso/flux	CCT	Kg	colore/colour	codice/code
------	-------------	-------------	-----	----	---------------	-------------

CALABRONE 4 spot						
4x9W 230V	narrow	4x1334lm	3000K	3,5	● nero/black	2090/DIM/NE
a richiesta fascio medio e largo / medium and wide beam on request						

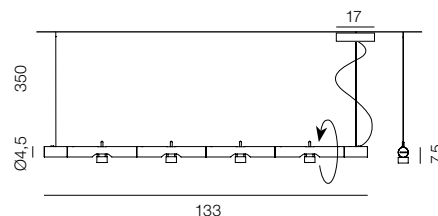

CALABRONE 8 spot						
8x9W 230V	narrow	8x1334lm	3000K	7	● nero/black	2090/G/DIM/NE
a richiesta fascio medio e largo / medium and wide beam on request						

a richiesta con un solo rosone centrale Ø31
on request with a single central ceiling rose Ø31

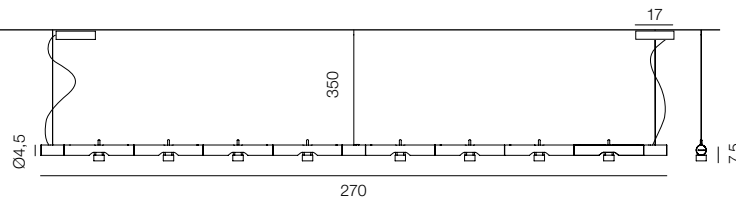

alimentatori elettronici dimmerabili nel rosone / electronic dimmable drivers



giunto meccanico / mechanical joint	● nero/black	30869/NE
-------------------------------------	--------------	----------

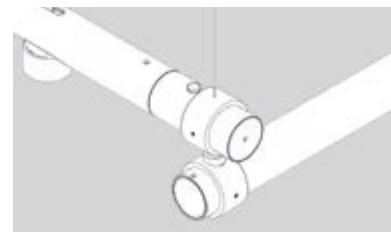

curva relativa a un singolo spot / single spot lighting curve

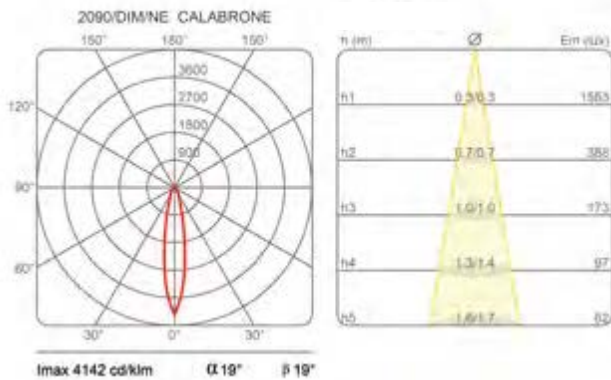







CALABRONE A

sospensione / suspension

Lampada a sospensione orientabile a luce diffusa. Struttura in tubolare di alluminio verniciato nel colore nero, con asola per diffusore in policarbonato opal bianco. Giunto intermedio per unire i moduli. Sorgente di luce LED integrata.

Suspension lamp with adjustable diffused light. Black painted aluminium tubular structure. With the opal methacrylate diffuser. Intermediate joints to connect modules. Integrated LED light source .



watt	flusso/flux	CCT	Kg	colore/colour	codice/code
20W 230V	3810 lm	3000K	3	● nero/black	2097/NE

Rosone / Ceiling rose Ø23 H 3

Dispositivi remoti per la dimmerazione vedi pagina 527 / Remote dimming devices see page 527

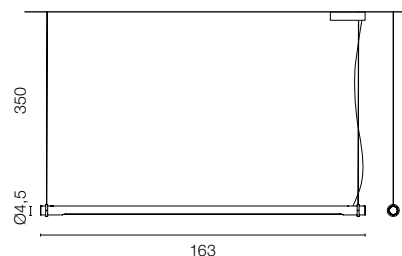

giunto meccanico / mechanical joint ● nero/black 30869/NE

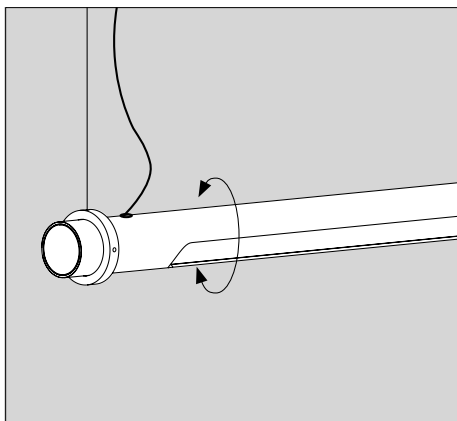
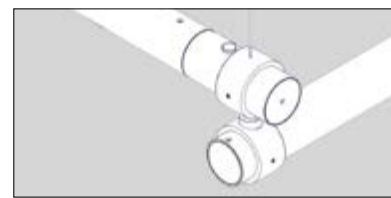
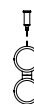

218

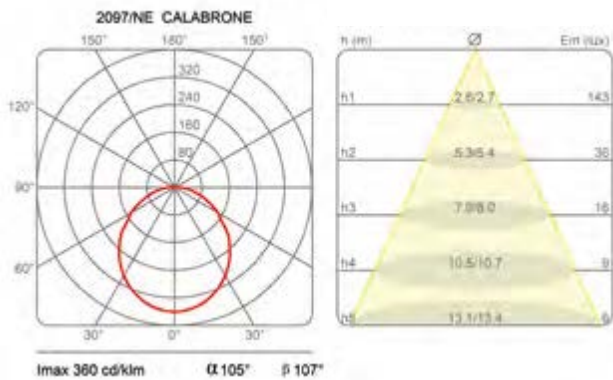







CALABRONE S

terra / floor



Lampada da terra a luce diretta orientabile.
 Struttura in alluminio verniciato nel colore nero, composta da moduli girevoli, con 3 spots direzionabili e indipendenti.
 Sorgente di luce a LED integrata.
 Disponibili lenti con diverse angolazioni del fascio di luce.
 Alimentatore elettronico integrato.

Standing lamp with swivel direct light.
 Black aluminium structure, composed of rotating modules with 3 adjustable and independent spots.
 Integrated LED light source.
 Available lenses with different angles of the light beam.
 Integrated electronic driver.



watt	fascio/beam	flusso/flux	CCT	Kg	colore/colour	codice/code
3x9W 230V	medium	3x1334lm	3000K	10	● nero/black	2293/3/NE
a richiesta fascio stretto e largo / narrow and wide beam on request						

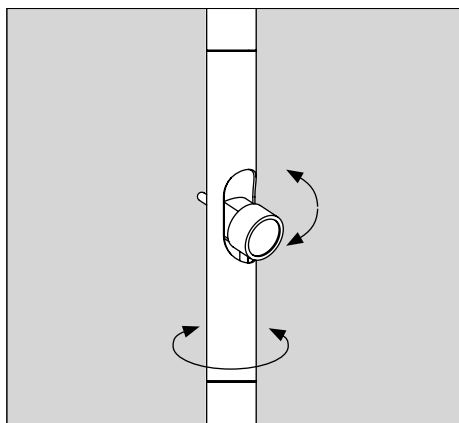

curva relativa a un singolo spot / single spot lighting curve

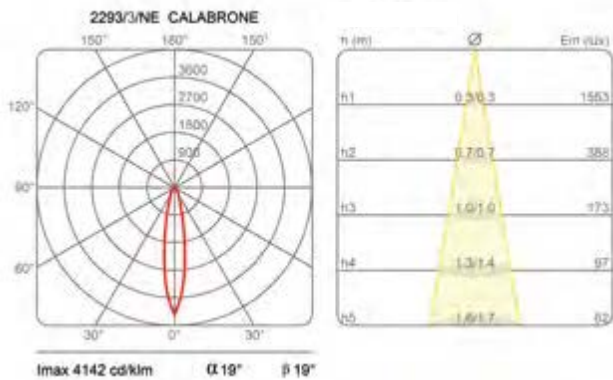







CALABRONE S

spot parete-soffitto / wall-ceiling spot

Lampada da soffitto e parete a luce diretta orientabile. Struttura in tubolare di alluminio nel colore nero con spot direzionabile. Sorgente di luce a LED integrata. Disponibili lenti con diverse angolazioni del fascio di luce. Disponibile in due versioni: con alimentatore integrato o remoto.

Wall or ceiling lamp with swivel direct light. Black tubular aluminium structure with adjustable spots. Integrated LED light source. Available lenses with different angles of the light beam. Available in two versions: with integrated or remote electronic driver.



watt	fascio/beam	flusso/flux	CCT	Kg	colore/colour	codice/code
------	-------------	-------------	-----	----	---------------	-------------

1x9W 230V	medium	1334lm	3000K	2,5	● nero/black	1433/NE
-----------	--------	--------	-------	-----	--------------	---------

a richiesta fascio stretto e largo / narrow and wide beam on request

alimentatore elettronico integrato / integrated electronic driver

1x9W 230V	medium	1334lm	3000K	2,5	● nero/black	1433/J/NE
-----------	--------	--------	-------	-----	--------------	-----------

a richiesta fascio stretto e largo / narrow and wide beam on request

alimentatore elettronico remoto / remote electronic driver

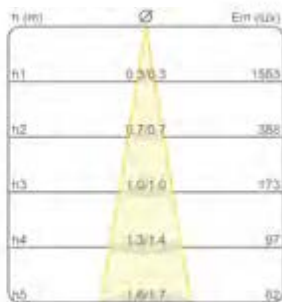
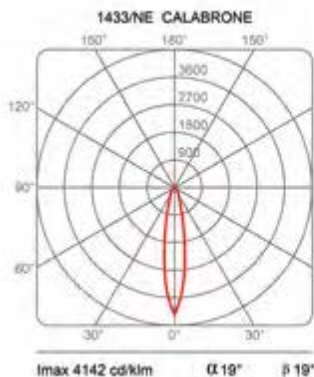
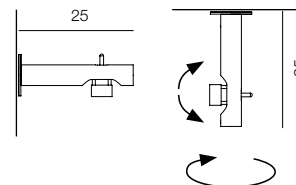
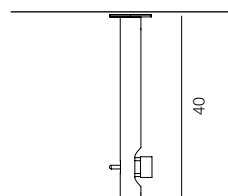



CALABRONET

Un sistema che fa della componibilità la sua specificità. Calabronet è composto da profili tubolari con spots orientabili per una luce d'accento e da profili con asola e diffusore in metacrilato per una luce diffusa. Dei giunti permettono il loro collegamento e la possibilità di ottenere varie composizioni, figure esagonali e percorsi lineari e reticolari.

A lighting system that makes modularity its characteristic trait. Calabronet consist of tubular profiles with swivel spotlights for an accent light, and elements featuring a slit and a methacrylate diffuser for a diffused light. Joints allow to connect them together, giving rise to several different compositions, hexagonal shapes and linear and lattices patterns.

Emiliana Martinelli e Andrea Menchini















CALABRONET

Sistema componibile a luce diretta/indiretta, diffusa e orientabile. Composto da moduli tubolari in alluminio in due lunghezze, uniti tra loro con particolari giunti.

Disponibile in due versioni: per LED 8W/20W (40030/NE – 40031/NE) per una luce diffusa, o nella variante (40033/NE) con spots orientabili e indipendenti, per sorgente di luce a LED integrata. Disponibili lenti con diverse angolazioni del fascio di luce. Alimentatore elettronico all'interno del rosone a soffitto, o da inserire nel controsoffitto.

Combinable swivel system with direct/indirect diffused light. Composed of two lengths of aluminium tubular profiles connected together with a particular joints.

Available in two versions: for 8w/20w LED (40030/NE – 40031/NE) for a diffused light, or in the version (40033/NE) with adjustable and independent spots for integrated LED light source. Available lenses with different angles of the light beam and an electronic driver placed inside the ceiling rose, to be fixed to the ceiling or placed inside a false ceiling.



watt	fascio/beam	flusso/flux	CCT	Kg	colore/colour	codice/code
------	-------------	-------------	-----	----	---------------	-------------

MODULO A LUCE DIFFUSA / DIFFUSED LIGHT MODULE 70

8W 24V		1100 lm	3000K	1,3	● nero/black	40030/NE
--------	--	---------	-------	-----	--------------	----------

MODULO A LUCE DIFFUSA / DIFFUSED LIGHT MODULE 160

20W 24V		2900 lm	3000K	1,5	● nero/black	40031/NE
---------	--	---------	-------	-----	--------------	----------

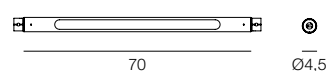
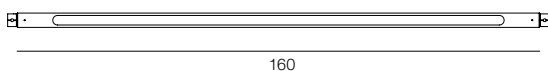

MODULO SPOT / SPOT MODULE 70

2x9W 24V	medium	2x1334lm	3000K	1,3	● nero/black	40033/NE
----------	--------	----------	-------	-----	--------------	----------

MODULO SPOT / SPOT MODULE 160

4x9W 24V	medium	4x1334lm	3000K	2,5	● nero/black	40137/NE
----------	--------	----------	-------	-----	--------------	----------

a richiesta fascio stretto e largo/ narrow and wide beam on request

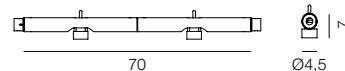

COMPONENTI / COMPONENTS

giunto 120° / 120° joint (A) con cavo di alimentazione / with power cable	0,2	● nero/black	40032/NE
--	-----	--------------	----------



giunto 90° / 90° joint (B)	0,2	● nero/black	40052/NE
----------------------------	-----	--------------	----------



giunto intermedio / intermediate joint (C)	0,2	● nero/black	40049/NE
--	-----	--------------	----------



testata di chiusura / closed head		● nero/black	40034/NE
-----------------------------------	--	--------------	----------



terminale con testata di chiusura e cavo di sospensione terminal with closed head and hanging cable		● nero/black	40037/NE
--	--	--------------	----------



cavo di alimentazione / power cable 350cm

Esempio di composizione libera con l'utilizzo dei moduli LED a luce diffusa orientabile e con spot direzionabili per una luce d'accento, uniti con il particolare giunto a 120° - 40032/NE.

Free composition example with the use of LED modules with swivel diffused light and adjustable spotlights for an accent light, connected with a special 120° joint - 40032/NE.

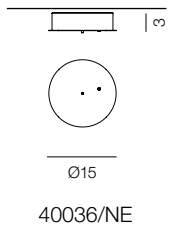
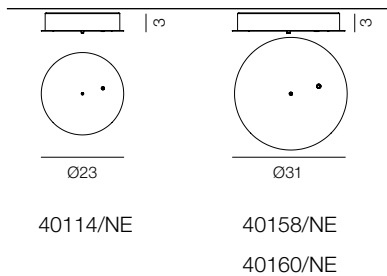
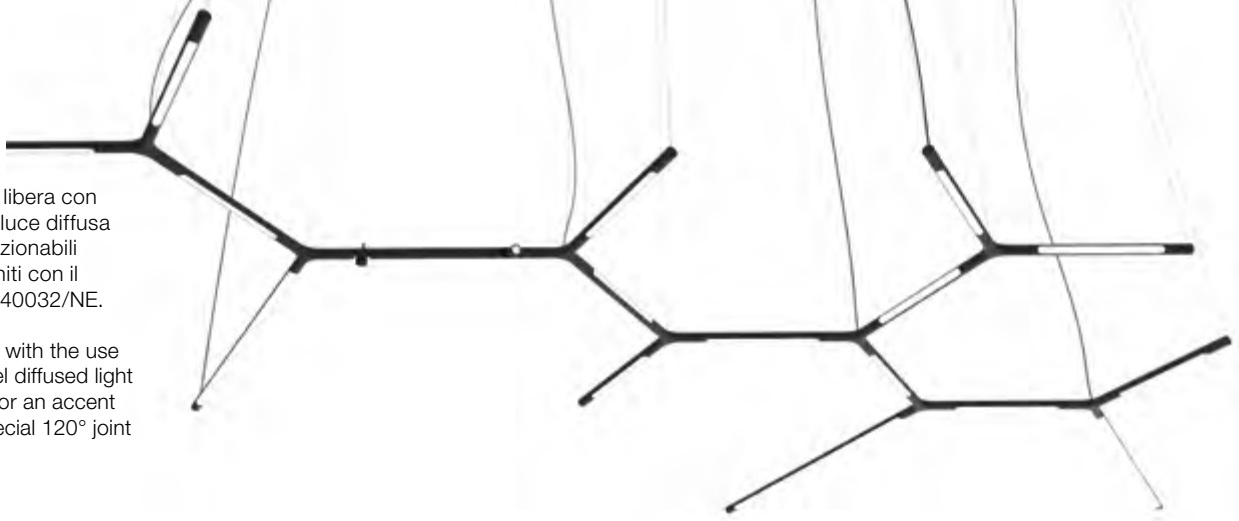

Esempio di composizione libera con l'utilizzo dei moduli LED a luce diffusa orientabile e con spot direzionabili, uniti con i diversi giunti (A,B,C).

Free composition examples with the use of LED modules with swivel diffused light and adjustable spotlights connected with a different joints (A,B,C).



watt	colore/colour	codice/code
ROSONI / CEILING ROSES		
rosone con alimentatore non dimmerabile / ceiling rose with non dimmable driver		
50W 230/24V	● nero/black	40036/NE
75W 230/24V	● nero/black	40114/NE
150W 230/24V	● nero/black	40158/NE
240W 230/24V	● nero/black	40160/NE

Dispositivi remoti per la dimmerazione vedi pagina 527 / Remote dimming devices see page 527

cavo di alimentazione / power cable L 350cm

La scelta del codice del rosone nelle diverse composizioni è legato alla somma dei Watt dei singoli moduli, a luce diffusa e a spot.
The choice of the ceiling rose code in the different compositions is related to the sum of the watts of the different spot modules with diffused light.

alimentatori elettronici dimmerabili a richiesta / electronic dimmable drivers on request

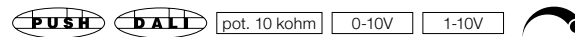

curva relativa a un singolo spot
single spot lighting curve

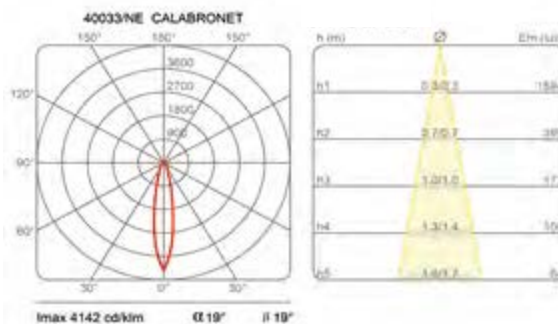

CALABRONET TRIS

La serie Calabronet si amplia con una nuova sospensione. Tre elementi tubolari disposti a intervalli di 120, sono uniti da un giunto centrale da cui parte il cavo di alimentazione.

Una sospensione da comporre, che supporta bracci sia a luce diretta con spot orientabili indipendenti, sia a luce diffusa attraverso un'asola.

Nata per soddisfare le diverse esigenze di illuminazione, unisce design, tecnologia, modularità, dinamicità: il file rouge della produzione Martinelli Luce.

Calabronet series grows with a new pendant lamp. Three tubular elements arranged with 120° intervals, are connected by a central joint from which the power cable starts. A pendant lamp to be composed, which supports arms with both direct light with independently adjustable spots and diffused light through a slot. Created to meet different lighting needs, it combines design, technology, modularity, dynamism: the fil rouge of Martinelli Luce production.

Emiliana Martinelli











CALABRONET TRIS



Sospensione singola, una variante del sistema Calabronet. Formata da tre bracci in tubolare di alluminio verniciato, orientabili, con diffusore in policarbonato opal bianco o con spot orientabili.

I tre bracci, con spot o con asola, sono uniti con il particolare giunto tris. I tre cavi di sospensione fissati alle estremità dei bracci si collegano al cavo centrale tramite un piccolo supporto cilindrico. Questo sistema di cavi permette di variare l'assetto orizzontale. Sorgente di luce a LED e alimentatore dimmerabile integrato nel rosone al soffitto.

Single suspension lamp, a variant of the Calabronet system.

It consists of three adjustable arms in painted tubular aluminium with a white opal polycarbonate diffuser. The arms are joined with the special tris joint, and connected with the steel cable attached at the ends to the central suspension cable by means of the small cylindrical central support that allows the horizontal or inclined position to be varied. LED light source and dimmable driver integrated in the ceiling rose.



watt	fascio/beam	flusso/flux	CCT	Kg	colore/colour	codice/code
------	-------------	-------------	-----	----	---------------	-------------

MODULO A LUCE DIFFUSA / DIFFUSED LIGHT MODULE 70

8W 24V		1100 lm	3000K	1,3	● nero/black	40030/NE
--------	--	---------	-------	-----	--------------	----------

MODULO A LUCE DIFFUSA / DIFFUSED LIGHT MODULE 160

20W 24V		2900 lm	3000K	1,5	● nero/black	40031/NE
---------	--	---------	-------	-----	--------------	----------

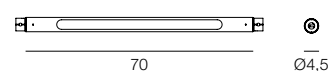
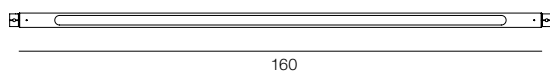

MODULO SPOT / SPOT MODULE 70

2x9W 24V	medium	2668lm	3000K	1,3	● nero/black	40033/NE
----------	--------	--------	-------	-----	--------------	----------

MODULO SPOT / SPOT MODULE 160

4x9W 24V	medium	5336lm	3000K	2,5	● nero/black	40137/NE
----------	--------	--------	-------	-----	--------------	----------

a richiesta fascio stretto e largo/ narrow and wide beam on request

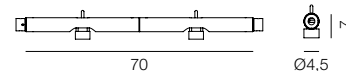

COMPONENTI / COMPONENTS

giunto 120° / 120° joint (A) con cavo di alimentazione / with power cable	0,2	● nero/black	40032/NE
--	-----	--------------	----------



terminale con testata di chiusura e cavo di sospensione terminal with closed head and hanging cable		● nero/black	40037/NE
--	--	--------------	----------

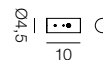

ROSONI / CEILING ROSES

rosone con alimentatore non dimmerabile / ceiling rose with non dimmable driver

75W 230/24V	● nero/black	40114.1/NE
-------------	--------------	------------

150W 230/24V	● nero/black	40158.1/NE
--------------	--------------	------------

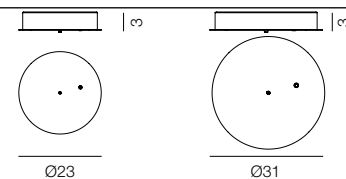

Dispositivi remoti per la dimmerazione vedi pagina 527 / Remote dimming devices see page 527



COMPOSIZIONI

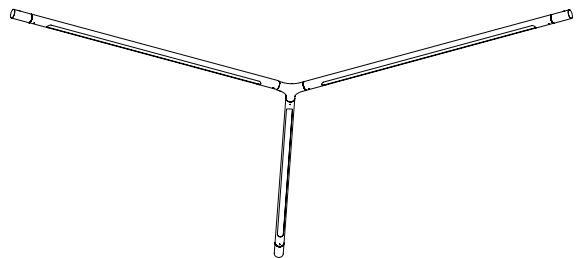
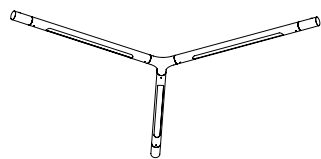
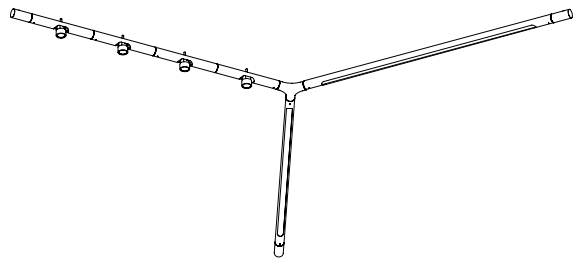
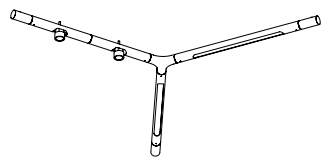
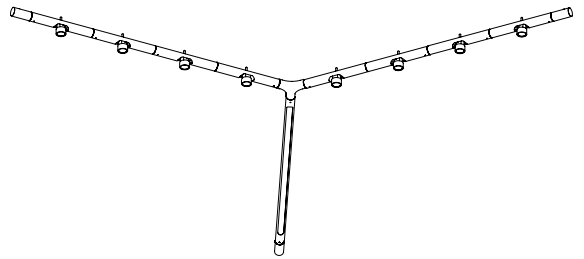
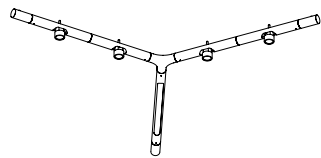
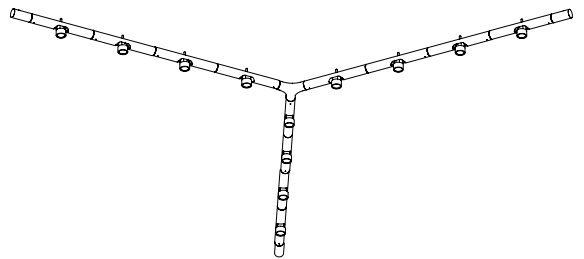
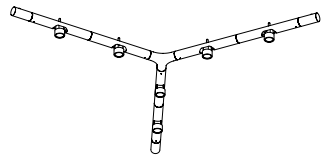

SHANGHAI

Il sistema Shanghai nasce dal desiderio di giocare con la luce nello spazio. Con pochi e semplici elementi realizzati in policarbonato, per la versione a sospensione o a parete, e un tubo fluorescente o a led, è possibile comporre molteplici combinazioni luminose all'interno dei diversi spazi architettonici. La semplicità del sistema e la sua informalità trasmettono freschezza e dinamicità.

The Shanghai lighting system comes from the desire to play with light in space.

With just a few simple elements in polycarbonate for the suspension or wall version, and a fluorescent or LED tube, it is possible to create many light combinations within different architectural environments.

The simplicity of the system and its informality transmit freshness and dynamism.

Studio Lucchi & Biserni, Angelo Micheli











SHANGHAI

sospensione / suspension



Sistema componibile a luce diffusa per tubi LED. Realizzato con elementi tubolari in policarbonato trasparente uniti con giunti terminali e intermedi in policarbonato bianco o trasparente. I giunti sono completi di cavo in acciaio e di cavo di alimentazione da collegare all'alimentatore cablatto all'interno del rosone in alluminio verniciato da fissare al soffitto.

Modular diffuse lighting system for LED tubes. It is made of tubular transparent polycarbonate elements connected by terminal or intermediate joints, made of white or transparent polycarbonate. Joints complete of stainless cables and power cables to be connected to the driver inside the painted aluminium ceiling rose.



watt	colore/colour	codice/code
------	---------------	-------------

GIUNTO TERMINALE / TERMINAL JOINT (GF)

per tubo LED con cavo di alimentazione / for LED tube with power cable L 250 cm

1x25W LED G5 T5	<input type="radio"/> bianco/white	30642
	<input checked="" type="radio"/> trasparente/transparent	30642/T

per tubo LED senza cavo di alimentazione / for LED tube without power cable

1x25W LED G5 T5	<input type="radio"/> bianco/white	30642.1
	<input checked="" type="radio"/> trasparente/transparent	30642.1/T



GIUNTO INTERMEDIO / INTERMEDIATE JOINT (GI)

per tubo LED con cavo di alimentazione / for LED tube with power cable L 250 cm

2x25W LED G5 T5	<input type="radio"/> bianco/white	30640
	<input checked="" type="radio"/> trasparente/transparent	30640/T

per tubo LED senza cavo di alimentazione / for LED tube without power cable

2x25W LED	<input type="radio"/> bianco/white	30640.1
	<input checked="" type="radio"/> trasparente/transparent	30640.1/T



TUBO LED / LED TUBE

25W LED G5 T5 3630lm 3000K	5289.2
----------------------------	--------

TUBO PER IL COLLEGAMENTO DEI GIUNTI / TUBE FOR THE CONNECTION OF JOINTS (T)

tubo in policarbonato trasparente con attacco per collegare i giunti terminali e intermedi.
transparent polycarbonate tube with support for connection of terminal and intermediate joints.

<input checked="" type="radio"/> trasparente/transparent	30647
--	-------

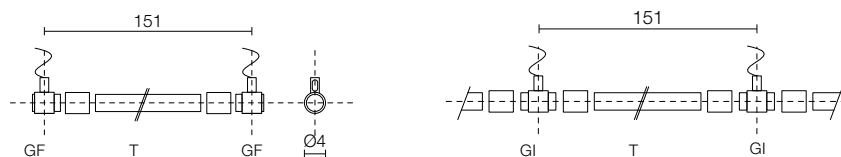

SHANGHAI

sospensione / suspension

ESEMPI / EXAMPLES

CONFIGURAZIONE SINGOLA / SINGLE CONFIGURATION

1 TUBO LED / 1 LED TUBE

- Y 1 rosone / ceiling rose
30721
- GF 2 giunti finali per T5 / joints terminals for T5
30642+30642.1 (30642/T+30642.1/T)
- T 1 tubo in policarbonato / polycarbonate tube
30647
- W2 1 cavi d'alimentazione / electrical wires

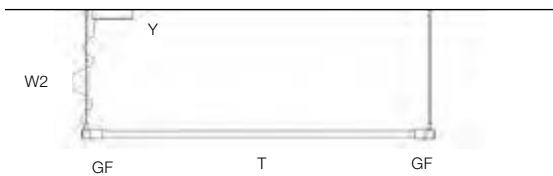

CONFIGURAZIONE DOPPIA / DOUBLE CONFIGURATION

2 TUBI LED / 2 LED TUBES

- Y 1 rosone / ceiling rose
30721
- GF 2 giunti finali per T5 / terminal joints for T5
30642.1 (30642.1/T)
- GI 1 giunto intermedio per T5 / intermediate joint for T5
30640 (30640/T)
- T 2 tubi in policarbonato / polycarbonate tubes
30647
- W2 1 cavi d'alimentazione / electrical wires

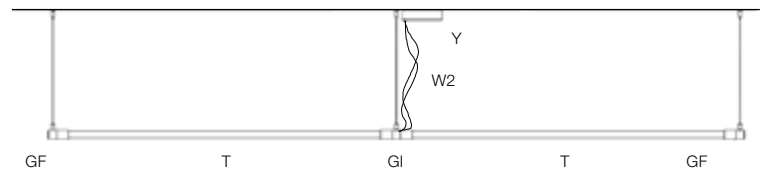

SHANGHAI

parete - soffitto / wall - ceiling



Sistema componibile a luce diffusa per tubi fluorescenti o a LED. Realizzato con elementi tubolari in policarbonato trasparente uniti con giunti terminali e intermedi in policarbonato bianco o trasparente, con supporto e basetta per il fissaggio a parete o soffitto. Alimentatore remoto.

Modular diffuse lighting system for fluorescent or LED tubes. It is made of tubular transparent polycarbonate elements connected by terminal or intermediate joints, made of white or transparent polycarbonate, with support and base for wall or ceiling mounting. Remote driver.



watt	colore/colour	codice/code
------	---------------	-------------

GIUNTO TERMINALE / TERMINAL JOINT (GF)

per tubo LED con cavo di alimentazione / for LED tube with power cable L 150 cm

1x25W LED G5 T5	<input type="radio"/> bianco/white	30728
	<input checked="" type="radio"/> trasparente/transparent	30728/T

per tubo LED senza cavo di alimentazione / for LED tube without power cable

1x25W LED G5 T5	<input type="radio"/> bianco/white	30728.1
	<input checked="" type="radio"/> trasparente/transparent	30728.1/T



GIUNTO INTERMEDIO / INTERMEDIATE JOINT (GI)

per tubo LED con cavo di alimentazione / for LED tube with power cable L 150 cm

2x25W LED G5 T5	<input type="radio"/> bianco/white	30729
	<input checked="" type="radio"/> trasparente/transparent	30729/T

per tubo LED senza cavo di alimentazione / for LED tube without power cable

2x25W LED	<input type="radio"/> bianco/white	30729.1
	<input checked="" type="radio"/> trasparente/transparent	30729.1/T

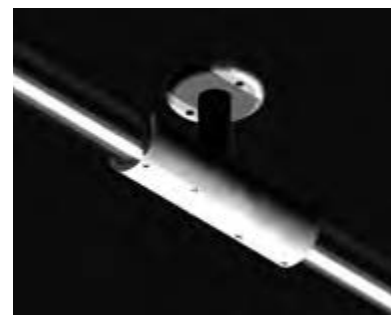

TUBO LED / LED TUBE

25W LED G5 T5 3630lm 3000K	5289.2
----------------------------	--------

TUBO PER IL COLLEGAMENTO DEI GIUNTI / TUBE FOR THE CONNECTION OF JOINTS (T)

tubo in policarbonato trasparente con attacco per collegare i giunti terminali e intermedi.
transparent polycarbonate tube with connection support to connect terminal and intermediate joints.

<input checked="" type="radio"/> trasparente/transparent	30647
--	-------

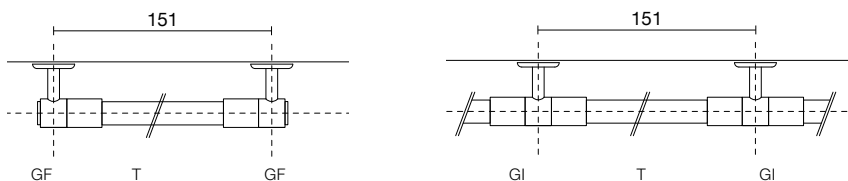

SHANGHAI

parete - soffitto / wall - ceiling

ESEMPI / EXAMPLES

CONFIGURAZIONE SINGOLA / SINGLE CONFIGURATION

1 TUBO LED / 1 LED TUBE

GF 2 giunti finali per T5 / terminal joints for T5
30728 + 30728.1

o

(30728/T + 30728.1/T)

T 1 tubo in policarbonato / polycarbonate tube
30647

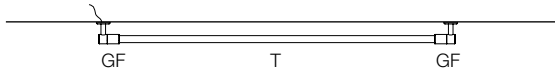

CONFIGURAZIONE DOPPIA / DOUBLE CONFIGURATION

2 TUBI LED / 2 LED TUBES

GF 2 giunti finali per T5 / terminal joints for T5
30728 + 30728.1

o

(30728/T + 30728.1/T)

GI 1 giunto intermedio per T5 / intermediate joint for T5
30729 (30729/T)

T 2 tubi in policarbonato / polycarbonate tubes
30647

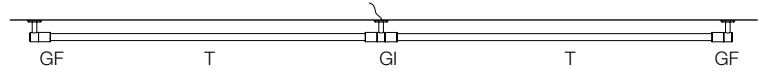

SHANGHAI LED

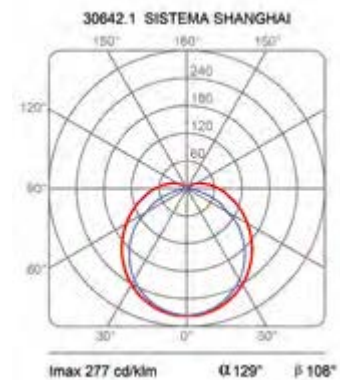

SHANGHAI

rosoni e accessori / ceiling rose and accessories

Rosoni in alluminio verniciato da fissare al soffitto completi di alimentatore per tubi fluorescenti o a LED.

Ceiling rose to fix on the ceiling with driver for fluorescent or LED tube.



watt	CCT	Kg	colore/colour	codice/code
------	-----	----	---------------	-------------

ROSONE / CEILING ROSE Ø12 H3

		0,5	○ bianco/white	30721/BI
--	--	-----	----------------	----------

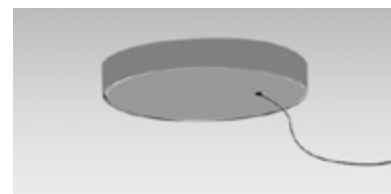

ACCESSORI / ACCESSORIES

schermo antiabbagliamento in alluminio / aluminium anti-glare screen

		0,5	● grigio/grey	30650
--	--	-----	---------------	-------

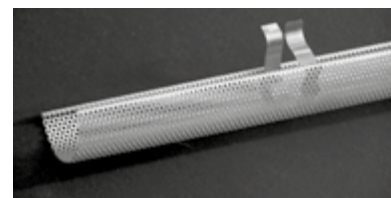

film radiant da inserire all'interno del tubo / radiant film to be placed inside the tube

		0,5	● multicolor	30775
--	--	-----	--------------	-------

film diffondente per tubo LED / diffusing film for LED tube

		0,5	○ bianco/white	30902
--	--	-----	----------------	-------

TUBO LED / LED TUBE

20W G5 T5 230V	3630lm 3000K			5289.2
----------------	--------------	--	--	--------

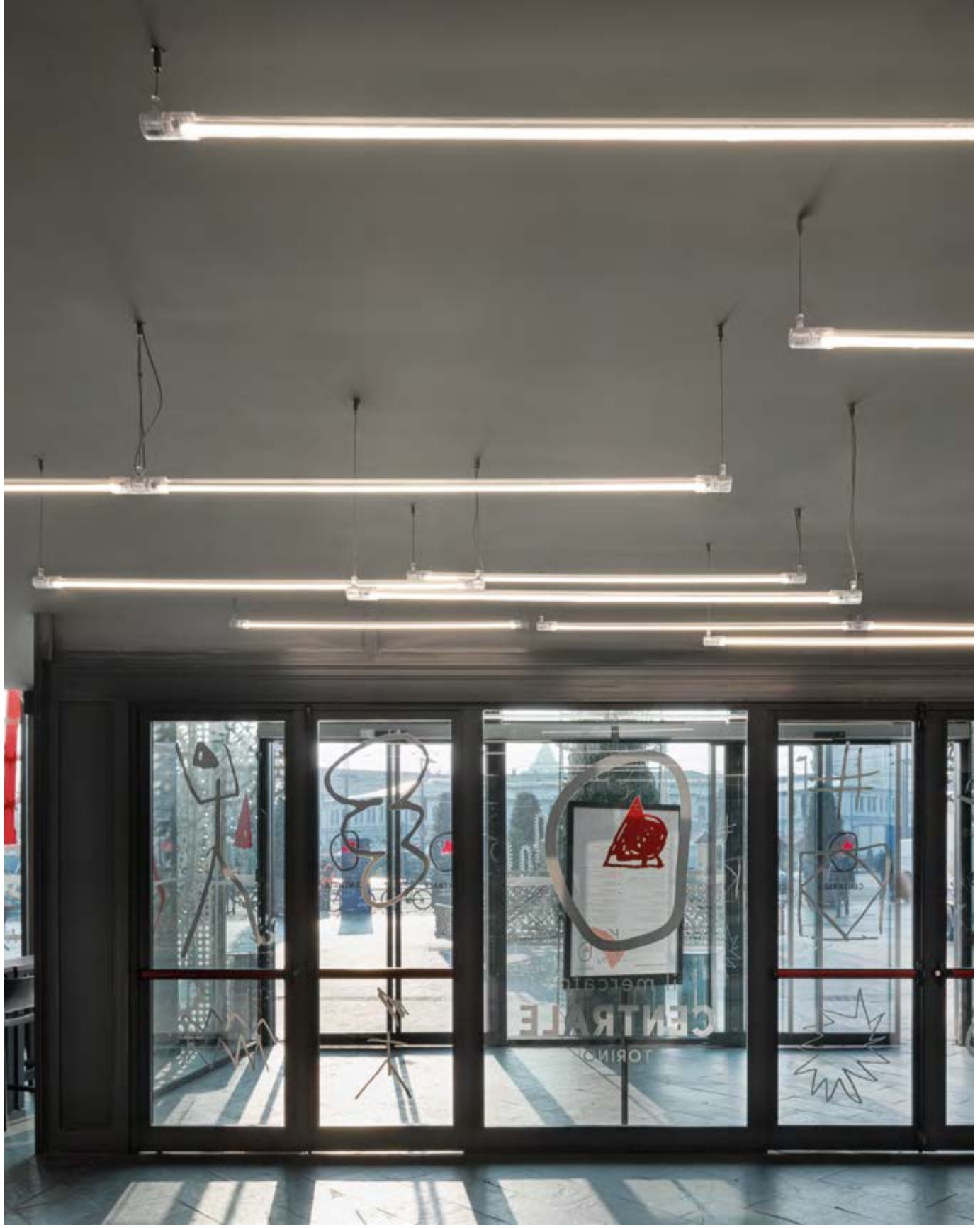

Mercato Centrale, Torino – Dolce e Luce Studio – arch. Barbara Nacarova

SHANGHAI

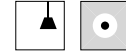

Lampada a sospensione formata da 2, da 3 e da 4 moduli tubolari indipendenti a luce diffusa.

È possibile regolare l'altezza e l'angolo di ogni modulo per creare diverse configurazioni.

Rosone in alluminio verniciato bianco.

Per tubi LED.

Suspension lamp with diffused light, made of 2, 3 and 4 tubular modules.

Possibility to adjust the height and angle of any module to create infinite configurations.

White painted aluminum ceiling rose.

For LED tube.



watt	colore/colour	codice/code
GIUNTO TERMINALE / TERMINAL JOINT (GF)		
con cavo di alimentazione / with power cable L 250 cm		
1x25W LED G5 T5	bianco/white	30642
	trasparente/transparent	30642/T
senza cavo di alimentazione / without power cable		
1x25W LED G5 T5	bianco/white	30642.1
	trasparente/transparent	30642.1/T
TUBO LED / LED TUBE		
25W G5 T5 3630lm 3000K		5289.2
TUBO PER IL COLLEGAMENTO DEI GIUNTI / TUBE FOR THE CONNECTION OF JOINTS (T)		
	trasparente/transparent	30647
ROSONI / CEILING ROSES		
per 2 tubi / for 2 tubes	bianco/white	40196/BI
per 3 tubi / for 3 tubes	bianco/white	40197/BI
per 4 tubi / for 4 tubes	bianco/white	40198/BI
ACCESSORI / ACCESSORIES		
schermo antiabbagliamento in alluminio / aluminium anti-glare screen		
0,5	grigio/grey	30650
film radiant da inserire all'interno del tubo / radiant film to be placed inside the tube		
0,5	multicolor	30775
film diffondente per tubo LED / diffusing film for LED tube		
0,5	bianco/white	30902



ESEMPI / EXAMPLES

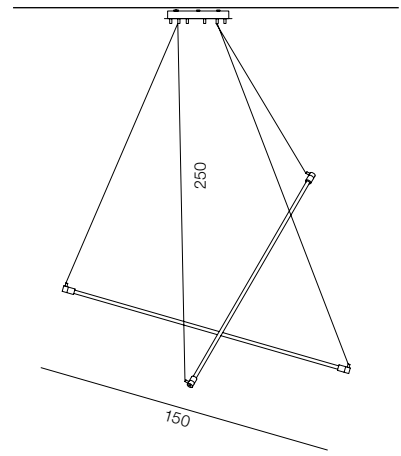
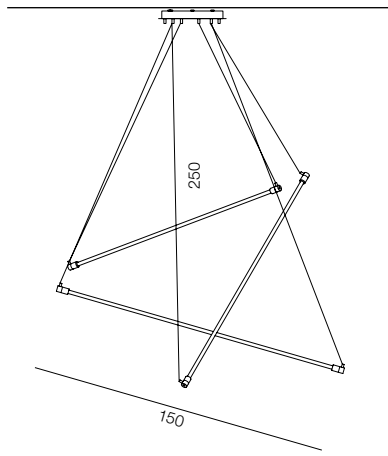
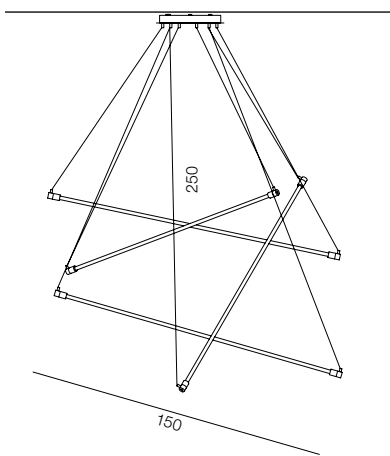

KOKO UNO

Koko è stata disegnata per il ristorante dal quale prende il nome; una luce che fosse al contempo funzionale e decorativa: in grado di esaltare i piatti e al tempo stesso rendere magica l'atmosfera del locale.

Questa doppia anima si è sviluppata attraverso due diversi elementi: un cilindro in metallo lucido, che proietta una luce concentrata, ed uno in metacrilato trasparente, luminescente per tutta la sua lunghezza. Questi possono essere declinati in varie lunghezze, installati ad altezze diverse e combinati in molteplici configurazioni, da un'illuminazione puntuale fino ad una vera e propria pioggia di luce, realizzando effetti scenografici dinamici e contemporanei, per questa versione composta consultare il catalogo architectural.

Nelle pagine successive presentiamo Koko nella versione singola a sospensione. Disponibile anche nella versione a parete e a soffitto nella sezione dedicata del presente catalogo.

Koko was designed for the restaurant from which it takes its name; a light that was both functional and decorative: able to enhance the dishes and at the same time make the atmosphere of the restaurant magical. This double soul was developed through two different elements: a polished metal cylinder, which projects a concentrated light, and one in transparent methacrylate, luminescent along its entire length. These can be declined in various lengths, installed at different heights and combined in multiple configurations, from a specific lighting to a real shower of light, creating dynamic and contemporary scenic effects.

For this combined version see the architectural catalogue.

On the following pages we present Koko in the single metal pendant version.

Also available in wall and ceiling versions in the dedicated section of this catalogue.

PLS DESIGN - LORENZO PERINI
& EMILIANA MARTINELLI



KOKO UNO

sospensione / suspension

Lampada a sospensione singola con rosone a luce diretta. Struttura in tubolare di alluminio in diverse finiture e misure.
Per sorgente di luce a LED.
Con alimentatore incluso nel rosone.

Single direct light suspension lamp with ceiling rose. Tubular aluminium structure in different finishes and sizes.
For LED light source.
With driver in the ceiling rose.



watt	fascio/beam	flusso/flux	CCT	Kg	colore/colour	codice/code
KOKO H80 Ø5,5						
9W LED	medium	1100lm	3000K	1,3	○ bianco/white	2093/BI
					● nero/black	2093/NE
					● oro p./p. gold	2093/AU
					● corten/corten	2093/CO
KOKO H50 Ø5,5						
9W LED	medium	1100lm	3000K	1,3	○ bianco/white	2093/50/BI
					● nero/black	2093/50/NE
					● oro p./p. gold	2093/50/AU
					● corten/corten	2093/50/CO

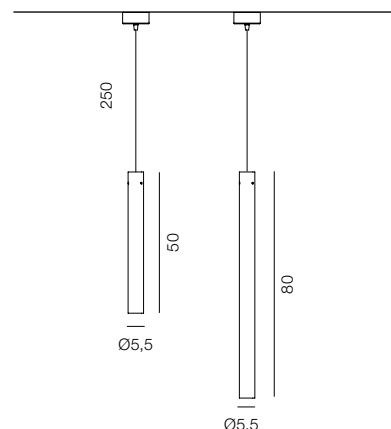

KOKO H80 Ø3						
4W LED	medium	420lm	3000K	1	○ bianco/white	2093/J/BI
					● nero/black	2093/J/NE
					● oro p./p. gold	2093/J/AU
					● corten/corten	2093/J/CO
KOKO H50 Ø3						
4W LED	medium	420lm	3000K	0,8	○ bianco/white	2093/J/50/BI
					● nero/black	2093/J/50/NE
					● oro p./p. gold	2093/J/50/AU
					● corten/corten	2093/J/50/CO

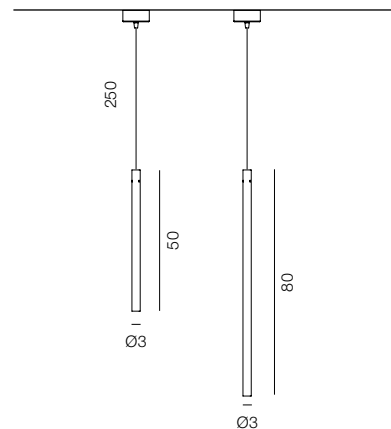



KOKO UNO

soffitto / ceiling

Lampada da soffitto a luce diretta. Struttura in tubolare di alluminio lucido o verniciato in diverse finiture.
Sorgente di luce a LED e alimentatore integrati nel corpo lampada.

Ceiling lamp with direct light. Painted aluminum tubular structure in different finishings. LED light source and electronic driver integrated in the body lamp.



watt	fascio/beam	flusso/flux	CCT	Kg	colore/colour	codice/code
9W LED	medium	1100lm	3000K	0,7	bianco/white	2899/BI
					nero/black	2899NE
					oro p./p. gold	2899/AU
					corten/corten	2899/CO

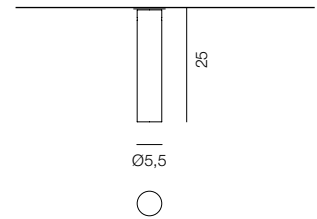

264

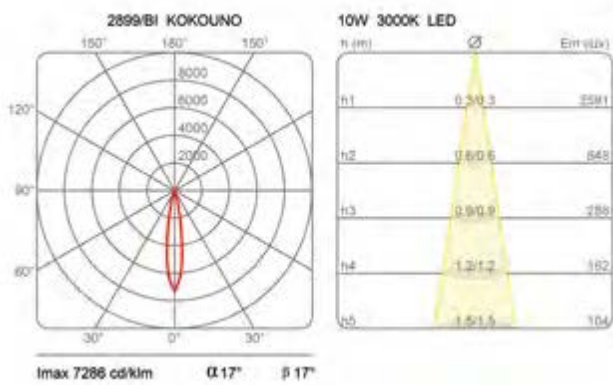



KOKO UNO

parete / wall



Lampada da parete a luce diretta/indiretta (cod. 1454) o a luce diretta (cod. 1454/J). Struttura in tubolare di alluminio lucido o verniciato in diverse finiture.

Sorgente di luce a LED e alimentatore integrati nel corpo lampada.

Disponibile in due lunghezze.

Wall lamp with direct/indirect light (cod. 1454) or direct light (cod. 1454/J). Structure in polished or painted tubular aluminium in different finishes.

LED light source and electronic driver integrated in the body lamp.

Available in two lengths.



watt	fascio/beam	flusso/flux	CCT	Kg	colore/colour	codice/code
------	-------------	-------------	-----	----	---------------	-------------

KOKO H50 luce diretta-indiretta/direct-indirect light

2x9W LED	medium	2x1100lm	3000K	0,5	○ bianco/white	1454/BI
					● nero/black	1454/NE
					● oro p./p. gold	1454/AU
					● corten/corten	1454/CO

KOKO H25 luce diretta/direct light

9W LED	medium	1100lm	3000K	0,5	○ bianco/white	1454/J/BI
					● nero/black	1454/J/NE
					● oro p./p. gold	1454/J/AU
					● corten/corten	1454/J/CO

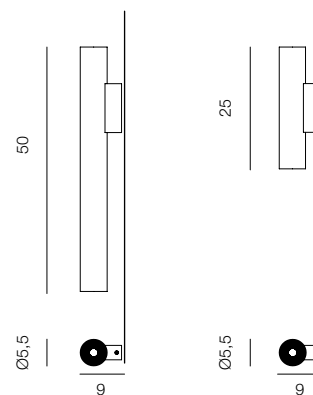

1454

1454/J

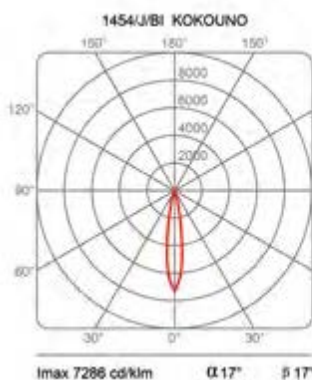



SISTEMA U

LIGHTYOU LIKE

Un semplice binario elettrificato da fissare al soffitto, a parete o sospeso, supporta degli spots orientabili e posizionabili su tutta la lunghezza del modulo.

Disponibile anche nelle versioni a sospensione come faretto singolo e a parete con supporto.

Sorgente di luce a LED con ottiche intercambiabili, dimmerabile con tecnologia bluetooth, per soddisfare le varie esigenze illuminotecniche sia in ambito espositivo che di lavoro.

A simple electrified track to be fixed to the ceiling, to the wall, or hanging, supports a adjustable spotlights that can be positioned along the entire length of the module. Also available as single suspension spotlight and wall support versions.

LED light source with interchangeable optics, dimmable with bluetooth technology, to satisfy various lighting needs both in exhibition and in workplace contexts.

Studio Natural







SISTEMA U

spot per binario / spot for track



Il Sistema U è composto da faretto a luce diretta orientabile con un particolare snodo. Caratterizzati da un attacco che abbraccia e si collega al binario elettrificato 48V da sospendere, da fissare a soffitto o parete. Sorgente di luce a LED con ottiche a diversi fasci di luce.

Alimentatore remoto o nel rosone al soffitto, dimmerabile con dispositivo bluetooth con binario compatibile.

Sistema U is composed of direct-light spotlights that can be oriented thanks to a special adjustable joint. It is characterized by a terminal that embraces and connected to the electrified track 48V to be suspended or fixed to the ceiling or wall.

LED light source with different light beams optics. Remote driver or in the ceiling rose, dimmable with bluetooth device with compatible track.



watt	fascio/beam	flusso/flux	CCT	Kg	colore/colour	codice/code
------	-------------	-------------	-----	----	---------------	-------------

FARETTO non dimmerabile / non dimmable SPOT

13W 48V	narrow	1950lm	3000K	0,5	○ bianco/white	1441/20/BI
	narrow				● nero/black	1441/20/NE
	wide				○ bianco/white	1441/38/BI
	wide				● nero/black	1441/38/NE

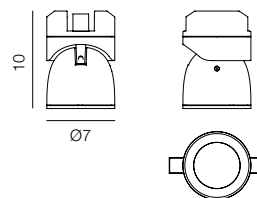

FARETTO dimmerabile / dimmable SPOT

13W 48V	narrow	1950lm	3000K	0,5	○ bianco/white	1441/20/DIM/BI
	narrow				● nero/black	1441/20/DIM/NE
	wide				○ bianco/white	1441/38/DIM/BI
	wide				● nero/black	1441/38/DIM/NE

BLUETOOTH

dispositivo Casambi bluetooth per la dimmerazione indipendente di ogni singolo faretto - in abbinamento ai faretto dimmerabili - (Casambi app. iOS e Android free) 545J 

bluetooth device for an independent dimming of each individual spotlight together with dimmable spotlights (Casambi app. iOS e Android free)

dispositivo per la dimmerazione PUSH del binario elettrificato 48V da ordinare in abbinamento ai faretto dimmerabili 500X

bluetooth device to dimmer the 48V electrified track to be ordered together with the dimmable spotlights

per binario elettrificato a 48V, alimentatore remoto e rosone con alimentatore vedi pagine 326-329 dedicate ai binari.

for 48V electrified track, remote driver and ceiling rose with driver, see the pages 326-329 dedicated to the tracks.

ACCESSORIO ANTIABBAGLIAMENTO / ANTIGLARING ACCESSORY

honey comb ● nero/black 40087/NE

UGR<19

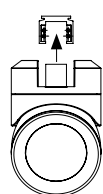

binario elettrificato
electrified track

spot

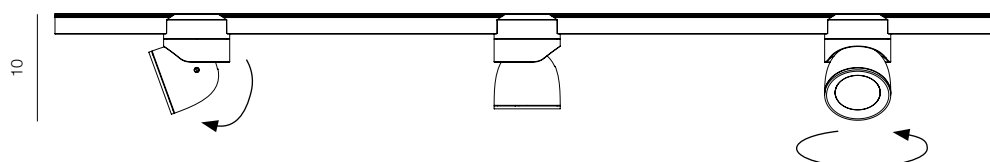

SISTEMA U - NARROW

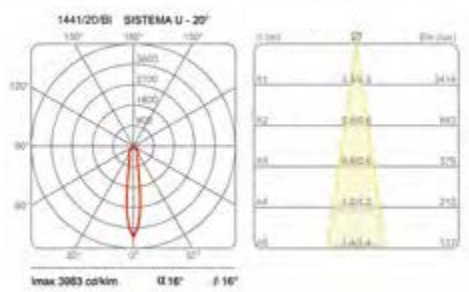

SISTEMA U - NARROW + HONEY COMB

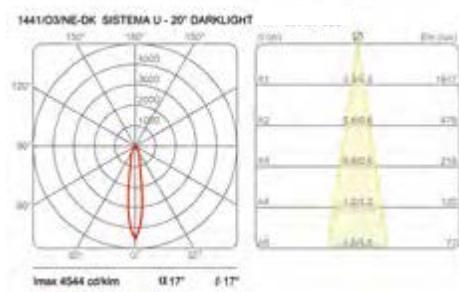

SISTEMA U - WIDE

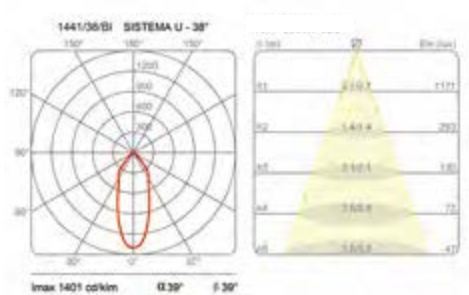

SISTEMA U - WIDE + HONEY COMB

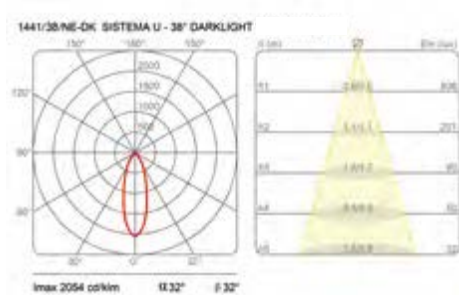





SISTEMA U

soffitto-parete / ceiling-wall



Faretto da parete a luce diretta, orientabile con un particolare snodo. Struttura in alluminio verniciato.

Sorgente di luce a LED con ottiche a diversi fasci di luce.

Alimentatore integrato nel corpo lampada o remoto.

Direct-light spotlight that can be oriented thanks to a special adjustable joint. Painted aluminium structure.

LED light source with different light beams optics.

Integrated driver or remote.



watt	fascio/beam	flusso/flux	CCT	Kg	colore/colour	codice/code
FARETTO SPOT L17						
13W 230V	narrow	1950lm	3000K	0,5	○ bianco/white	1452/20/BI
	narrow				● nero/black	1452/20/NE
	wide				○ bianco/white	1452/38/BI
	wide				● nero/black	1452/38/NE

alimentatore integrato nel corpo lampada / power supply integrated in the body lamp

230/350mA

non dimmerabile / non dimmable

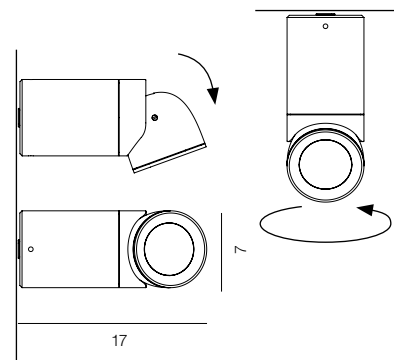

FARETTO SPOT L10						
13W 350mA	narrow	1950lm	3000K	0,5	○ bianco/white	1452/J/20/BI
	narrow				● nero/black	1452/J/20/NE
	wide				○ bianco/white	1452/J/38/BI
	wide				● nero/black	1452/J/38/NE

alimentatore remoto / remote driver

40W 230V/350mA (max 3 spots)

0,6

40164

40W 230V/350mA (max 3 spots)

dimmerabile / dimmable



1

40165

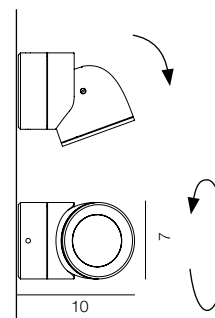

ACCESSORIO ANTIABBAGLIAMENTO / ANTIGLARING ACCESSORY

honey comb

● nero/black

40087/NE

UGR<19







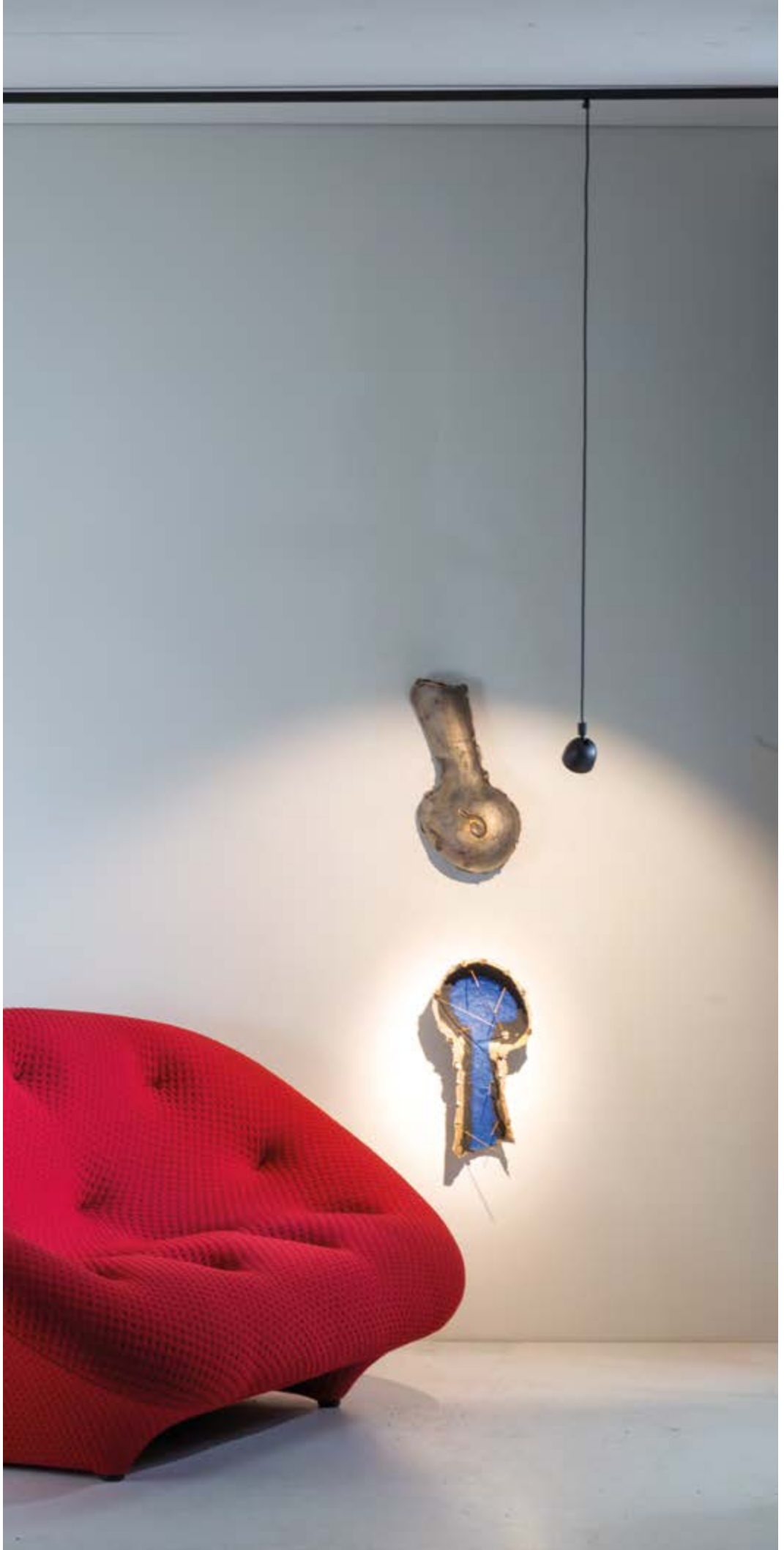

SISTEMA U

sospensione singola con rosone / single suspension with ceiling rose

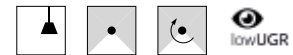

Faretto a sospensione a luce diretta, orientabile. Struttura in alluminio verniciato. Sorgente di luce a LED con ottiche a diversi fasci di luce.

Con cavo di sospensione e rosone per sospensione singola.

Suspension lamp with direct light, adjustable. Painted aluminum structure.

LED light source with optics in different light beams.

With suspension cable and ceiling rose for single suspension.



watt	fascio/beam	flusso/flux	CCT	Kg	colore/colour	codice/code
------	-------------	-------------	-----	----	---------------	-------------

FARETTO con alimentatore remoto / SPOT with remote driver

13W 350mA	narrow	1950lm	3000K	0,5	○ bianco/white	21014/20/BI
	narrow				● nero/black	21014/20/NE
	wide				○ bianco/white	21014/38/BI
	wide				● nero/black	21014/38/NE

alimentatore remoto / remote driver

40W 230V/350mA (max 3 spots)				0,6		40164
40W 230V/350mA (max 3 spots)				1		40165



FARETTO con alimentatore integrato / SPOT with integrated driver

13W 230V	narrow	1950lm	3000K	0,5	○ bianco/white	21013/20/BI
	narrow				● nero/black	21013/20/NE
	wide				○ bianco/white	21013/38/BI
	wide				● nero/black	21013/38/NE

rosone / ceiling rose Ø9 H4

alimentatore integrato nel rosone 230/350mA / integrated driver in the ceiling rose 230/350mA.

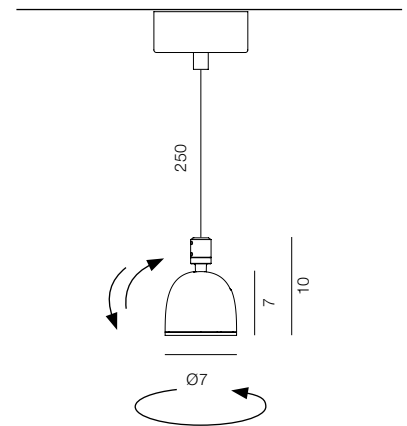

ACCESSORIO ANTIABBAGLIAMENTO / ANTIGLARING ACCESSORY

honey comb	● nero/black	40087/NE
UGR<19		

per diagrammi illuminotecnici vedi pagina precedente 291.
for lighting curve see the previous page 291.



CIP

LIGHTYOU LIKE

Faretti orientabili per una luce d'accento con attacco per binario elettrificato a 48V.

Per sorgente di luce a LED con ottiche diverse. Dimmerabile con tecnologia bluetooth.

Adatti per l'illuminazione in diversi ambiti, residenziale, espositivo e di lavoro.

Adjustable spotlights for an accent light with a 48V electrified track attachment.

For LED light source with different optics.

Dimmable with bluetooth technology.

Suitable for lighting in various areas: work, residential, exhibitions.

Emiliana Martinelli







CIP

Faretti orientabili per sorgente di luce LED con varie aperture del fascio luminoso, con adattatore per binario elettrificato 48V, a sospensione, da fissare al soffitto o da incasso.
Struttura in alluminio verniciato.
Alimentatore remoto o nel rosone al soffitto, dimmerabile con dispositivo bluetooth con binario compatibile.

UGR<19.

Swivel Spot for LED light source with various light beam angles and a 48V electrified track attachment, suspended, to fix on the ceiling or recessed versions.
Painted aluminium structure.
Remote driver or in the ceiling rose, dimmable with bluetooth device with compatible track.

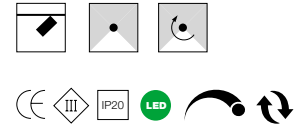

watt	fascio/beam	flusso/flux	CCT	Kg	colore/colour	codice/code
CIP non dimmerabile / non dimmable						
12W 48V	narrow 12°	1170lm	3000K	1	○ bianco/white	1449/14/BI
	narrow 12°				● nero/black	1449/14/NE
	wide 36°				○ bianco/white	1449/32/BI
	wide 36°				● nero/black	1449/32/NE
CIP dimmerabile / dimmable						
12W 48V	narrow 12°	1170lm	3000K	1	○ bianco/white	1449/14/DIM/BI
	narrow 12°				● nero/black	1449/14/DIM/NE
	wide 36°				○ bianco/white	1449/32/DIM/BI
	wide 36°				● nero/black	1449/32/DIM/NE

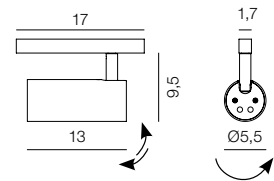



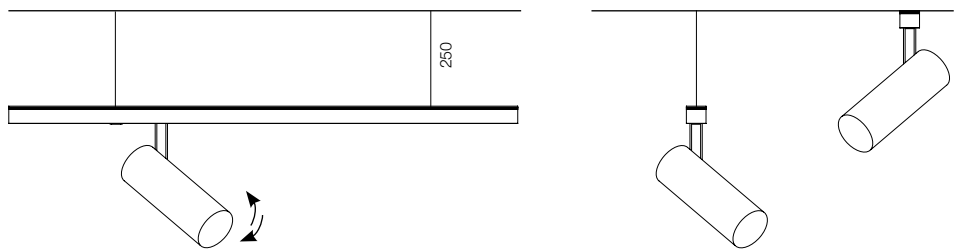

CIP binario / track

BINARIO A SOSPENSIONE / SUSPENSION TRACK



BINARIO DA INCASSO / RECESSED TRACK



BLUETOOTH  

dispositivo Casambi bluetooth per la dimmerazione indipendente di ogni singolo faretto - in abbinamento ai faretto dimmerabili - bluetooth device for an independent dimming of each individual spotlight together with dimmable spotlights

dispositivo per la dimmerazione PUSH del binario elettrificato 48V da ordinare in abbinamento ai faretto dimmerabili device to dimmer the 48V electrified track to be ordered together with the dimmable spotlights

545J  (Casambi app. iOS e Android free)

500X

CIP - NARROW

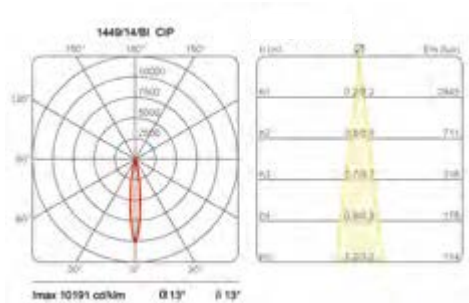

CIP - WIDE

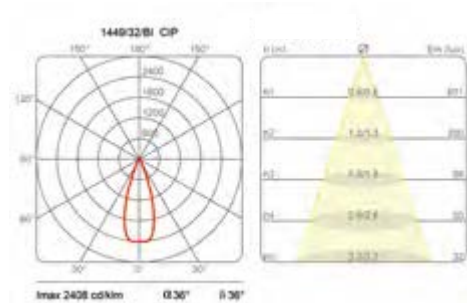

S23 sagomatore / shaper

Faretto sagomatore orientabili da interno per una luce d'accento per binari elettrificati a 230V. Sorgente di luce a LED ad alto rendimento luminoso. Le varie aperture del fascio luminoso permettono di soddisfare le esigenze illuminotecniche di esercizi commerciali, musei ed uffici.

Adjustable shaper spotlight for an accent lighting for 230V electrified track.

Source of LED light with a high lighting performance. The different light beams angles satisfy the lighting needs of shopping centers, museums and offices.

Studio Tecnico



S23 sagomatore / shaper

Faretto sagomatore di luce a luce diretta orientabile con adattatore per binario elettrificato a 48V o 230V. Gruppo lenti in polimetilmetacrilato per offrire un controllo preciso del fascio di luce. Struttura in alluminio verniciato. Ideale per applicazioni museali e retail. Dotato di alette in metallo regolabili dall'esterno che consentono di sagomare e regolare la forma del fascio luminoso, per forme circolari, quadrate e rettangolari. Vedi binari elettrificati nella pagine dedicate 326-329.

Adjustable direct-light shaper spotlight with adapter for 48V or 230V electrified track. The polymethylmethacrylate lens group offer a precise control of the light beam. Painted aluminium structure. Ideal for museums and retail applications. Equipped with externally adjustable metal wings that allow the shape of the light beam to be shaped and adjusted for circular, square and rectangular shapes. See electrified tracks related pages 326-329.



watt	fascio/beam	flusso/flux	CCT	Kg	colore/colour	codice/code
------	-------------	-------------	-----	----	---------------	-------------

S23 per binario 48V / S23 for 48V track

12W 48V	wide	350lm	3000K	0,6	○ bianco/white	2905/BI
					● nero/black	2905/NE

CRI>90

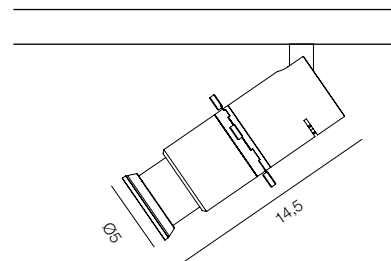

S23 per binario 230V / S23 for 230V track

12W 230V	wide	350lm	3000K	0,6	○ bianco/white	2905/230/BI
					● nero/black	2905/230/NE

CRI>90

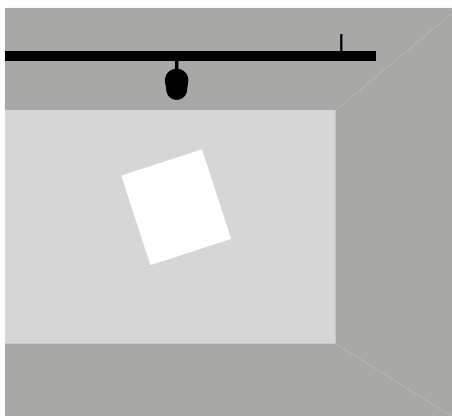
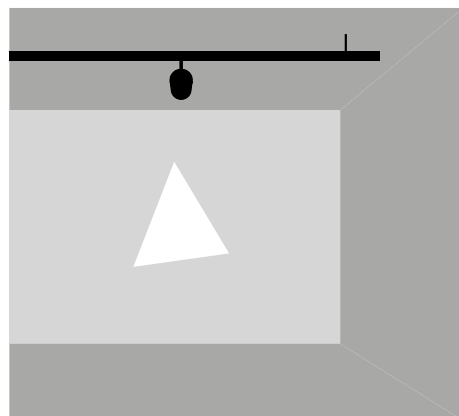
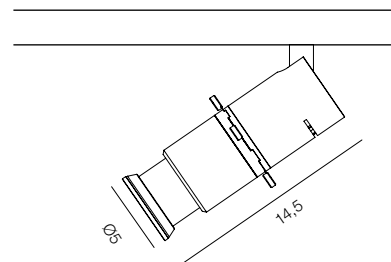



R23 zoom

Faretto orientabile da interno per una luce d'accento per binari elettrificati a 48V. Sorgente di luce a LED ad alto rendimento luminoso. Le varie aperture del fascio luminoso permettono di soddisfare le esigenze illuminotecniche di esercizi commerciali, musei ed uffici.

Adjustable device for an accent lighting for 48V electrified track.

Source of LED light with a high lighting performance. The different light beams angles satisfy the lighting needs of shopping centers, museums and offices.

Studio Tecnico



R23

Faretto a luce diretta orientabile con adattatore per binario elettrificato a 48V.
 Un sistema regolabile con lente bifocale, permette di controllare l'angolo di apertura del fascio di luce da narrow a wide mantenendo un'alta efficienza luminosa.
 Struttura in alluminio verniciato.
 Sorgente di luce a LED.
 Vedi binari elettrificati nella pagina dedicata 326-329.

Direct light adjustable LED projector, with adapter for 48V electrified track.
 Swiveling system with double bifocal lenses, wich allows the light beams angles to be controlled from narrow to wide while maintaining high levels of efficiency.
 Painted aluminium structure.
 For LED light source.
 See electrified tracks related pages 326-329.



watt	fascio/beam	flusso/flux CCT	Kg	colore/colour	codice/code
------	-------------	-----------------	----	---------------	-------------

R23					
18W 48V	narrow / very wide	1700lm 3000K	0,3	<input type="radio"/> bianco/white <input type="radio"/> nero/black	2904/BI 2904/NE

angolo del fascio regolabile da narrow 20° a very wide 50°
 adjustable beam angle from narrow 20° to very wide 50°

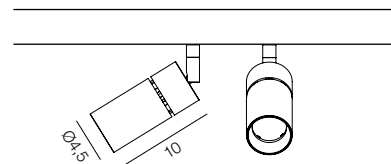

R23 J					
9W 48V	narrow / verywide	700lm 3000K		<input type="radio"/> bianco/white <input type="radio"/> nero/black	2904/J/BI 2904/J/NE

angolo del fascio regolabile da very narrow 20° a wide 50°
 adjustable beam angle from very narrow 20° to wide 50°

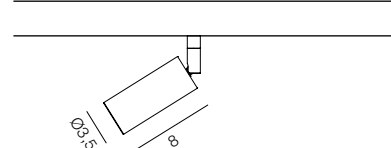

BLUETOOTH  

dispositivo Casambi bluetooth per la dimmerazione indipendente di ogni singolo faretto - in abbinamento ai faretto dimmerabili - (Casambi app. iOS e Android free) 545J 
 bluetooth device for an independent dimming of each individual spotlight together with dimmable spotlights (Casambi app. iOS e Android free)

dispositivo per la dimmerazione PUSH del binario elettrificato 48V da ordinare in abbinamento ai faretto dimmerabili 500X
 bluetooth device to dimmer the 48V electrified track to be ordered together with the dimmable spotlights



GRILLO

Un piccolissimo punto di luce orientabile e direzionabile sul suo supporto di fissaggio o per binario elettrificato, con sorgente di luce a LED, utile per creare effetti di luce e per valorizzare particolari.

An adjustable and directional tiny light point on its fixing support or for electrified track, with LED light source, useful to create lighting effects and to enhance details.

Emiliana Martinelli











GRILLO

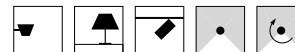

Una piccola luce orientabile e direzionabile adatta per esposizioni museali o commerciali per illuminazione di teche. Struttura in alluminio verniciato nel colore nero.

Sorgente di luce a LED integrata con varie aperture del fascio luminoso. Alimentatore elettronico remoto (escluso).

Disponibile nelle versioni: con supporto per il fissaggio su un piano o una mensola; o con attacco per binario elettrificato a 48V. Per il binario elettrificato a 48V, alimentatore remoto e rosone con alimentatore vedi pagine 326-329 dedicate ai binari.

A small adjustable and directional light suitable for museum or commercial exhibitions and for lighting cases.

Black painted aluminium structure. Integrated LED light source with various light beam angles. Remote electronic driver (excluded).

Available in the following versions: with support to be fixed on a surface or a shelf; or with 48V electrified track connection.

For the 48V electrified track, remote driver and ceiling rose with driver, see the pages 326-329 dedicated to the tracks.



watt	fascio/beam	flusso/flux	CCT	Kg	colore/colour	codice/code
------	-------------	-------------	-----	----	---------------	-------------

GRILLO con supporto / GRILLO with support

5W 24V	medium	360lm	3000K	0,4	● nero/black	1438/NE
--------	--------	-------	-------	-----	--------------	---------

su richiesta con fascio stretto / on request with a narrow beam

alimentatore elettronico remoto / remote electronic driver (max 3 spots)

20W 230/24V						505X
-------------	--	--	--	--	--	------

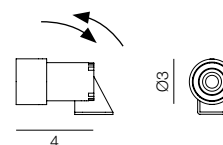

è possibile modificare il supporto di fissaggio del Grillo per adattarsi alle varie esigenze espositive (su richiesta).

it is possible to modify the Grillo fixing support in order to respond to the different exhibition needs (on request).

GRILLO con adattatori per binario 48V / GRILLO with track adapters 48V

adattatore con 1 spot / adapter with 1 spot

5W 24V	medium	360lm	3000K	0,4	● nero/black	1450/24/NE
--------	--------	-------	-------	-----	--------------	------------

adattatore con 2 spot / adapter with 2 spots

2x5W 24V	medium	2x360lm	3000K	0,7	● nero/black	1450/2/24/NE
----------	--------	---------	-------	-----	--------------	--------------

alimentatore elettronico remoto / remote electronic driver (max 4 spots)

25W

30811.1

su richiesta con fascio stretto / on request with a narrow beam

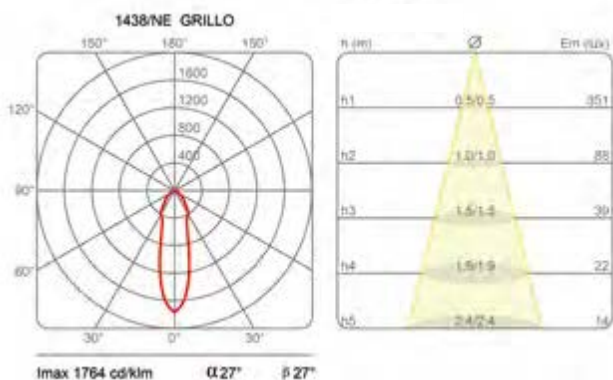
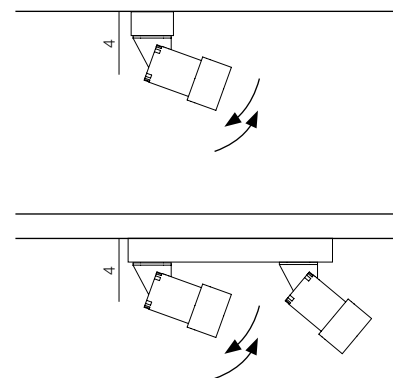



R11

Apparecchi orientabili da interno per una luce d'accento con supporto a parete o per cornicioni. Sorgente di luce a LED ad alto rendimento luminoso. Le varie aperture del fascio luminoso permettono di soddisfare le esigenze illuminotecniche di esercizi commerciali, musei, chiese ed uffici.

Adjustable devices for an accent lighting with wall or cornice mounting. Source of LED light with a high lighting performance. The different light beams angles satisfy the lighting needs of shopping centers, museums, churches and offices.

Emiliana Martinelli











R11

Apparecchio a luce diretta orientabile con supporto da parete.
 Sorgente di luce a LED con diversi fasci luminosi.
 Struttura in alluminio verniciato.
 Alimentatore elettronico integrato nella base.

Direct light adjustable LED projector, with wall mounting support.
 LED light source with different light beams.
 Structure in painted aluminium.
 Integrated electronic driver into the base.



watt	fascio/beam	flusso/flux	CCT	Kg	colore/colour	codice/code
35W 230V	medium 24°	4050lm	3000K	2	○ bianco/white	1407/P/XL/26D/BI
					● antracite/anthracite	1407/P/XL/26D/AN
	wide 36°				○ bianco/white	1407/P/XL/36D/BI
					● antracite/anthracite	1407/P/XL/36D/AN

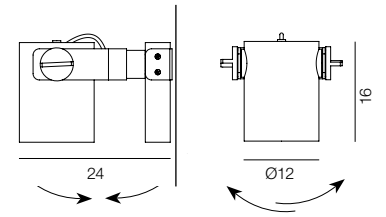



R11

Apparecchio a luce diretta orientabile con supporto e base per il fissaggio sopra a un cornicione o su altre superfici piane. Sorgente di luce a LED con diversi fasci luminosi. Struttura in alluminio verniciato. Alimentatore elettronico integrato nella base.

Direct light adjustable LED projector, with support and base for fixing over a cornice or flat surfaces. LED light source with different light beams. Structure in painted aluminium. Integrated electronic driver into the base.



watt	fascio/beam	flusso/flux	CCT	Kg	colore/colour	codice/code
35W 230V	medium 24°	4050lm	3000K	2	○ bianco/white	1407/C/XL/26D/BI
					● antracite/anthracite	1407/C/XL/26D/AN
	wide 36°				○ bianco/white	1407/C/XL/36D/BI
					● antracite/anthracite	1407/C/XL/36D/AN

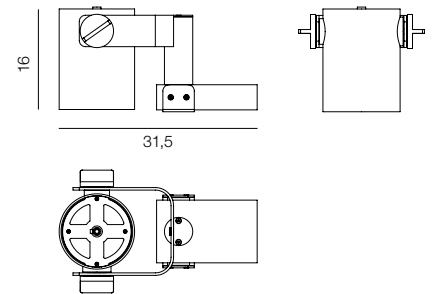



Chiesa di S. Giovanni Battista, Vietri sul mare, Salerno

R19 zoom

Faretti orientabili da interno per una luce d'accento per binari elettrificati a 230V. Sorgente di luce a LED ad alto rendimento luminoso. Le varie aperture del fascio luminoso permettono di soddisfare le esigenze illuminotecniche di esercizi commerciali, musei ed uffici.

Adjustable devices for an accent lighting for 230V electrified track. Source of LED light with a high lighting performance. The different light beams angles satisfy the lighting needs of shopping centers, museums and offices.

Studio Tecnico







R19

Faretto a luce diretta orientabile con attacco per binario elettrificato a 230V.
 Un sistema regolabile con lente bifocale, permette di controllare l'angolo di apertura del fascio di luce da narrow a wide mantenendo un'alta efficienza luminosa.
 Struttura in alluminio verniciato.
 Sorgente di luce a LED.
 Vedi binari elettrificati nella pagina dedicata 326-329.

Direct light adjustable LED projector, for 230V electrified track.
 Swiveling system with double bifocal lenses, wich allows the light beams angles to be controlled from narrow to wide while maintaining high levels of efficiency.
 Painted aluminium structure.
 For LED light source.
 See electrified tracks related pages 326-329.



watt	fascio/beam	flusso/flux	CCT	Kg	colore/colour	codice/code
20W 230V	narrow-wide	2430lm	3000K		○ bianco/white	2887/BI
					● nero/black	2887/NE

angolo del fascio regolabile da narrow a wide / adjustable beam angle from narrow to wide

alimentatore integrato nel corpo lampada / integrated driver included into the body lamp.

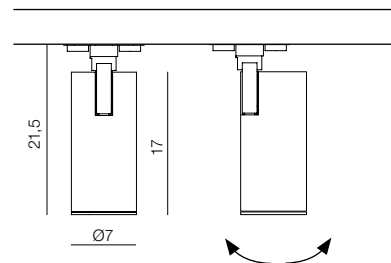

su richiesta sorgente di luce a LED di 10W e 30W / on request LED light source 10W e 30W



BINARI ELETTTRIFICATI ELECTRIFIED TRACKS

Una serie di binari elettrificati a 48V e 230V di varie lunghezze, di dimensioni ridotte. Nelle varianti da fissare al soffitto, a parete e a sospensione, ad incasso, per supportare i vari spot orientabili con i relativi attacchi: Sistema U, Grillo, Cip, R23, S23 per binario 48V. Spot R19, S23 per binario 230V. Particolari giunti di connessione permettono al binario di seguire lo spazio architettonico.

A series of electrified tracks in different lengths and with reduced dimensions, at 48V and 230V.
To be fixed to the ceiling, the wall, suspended, recessed, to support the different adjustable spotlights:
Sistema U, Grillo, Cip, R23, S23 for 48V track. Spots R19, S23 for 230V track.
Special connection joints allow the track to follow the architectural space.

Studio Tecnico







BINARIO ELETTRIFICATO / ELECTRIFIED TRACK 230V

Binario elettrificato a 230V da sospendere con cavo di acciaio o da fissare al soffitto. In alluminio anodizzato nero o bianco, e completo di vari componenti, vedi pagina a destra. Predisposto per i faretti R19, S23

230V electrified track to be suspended with steel cable or to be fixed to the ceiling, in black anodized or white aluminium, and complete with various components, see page on the right. Pre-arranged to fix R19, S23 spotlights.





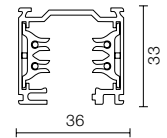

binario/track	Kg	colore/colour	codice/code
BINARIO ELETTRIFICATO A SOSPENSIONE - SOFFITTO / HANGING - CEILING ELECTRIFIED TRACK			
binario / track 100 cm	1,2	○ bianco/white	5955/BI
		● nero/black	5955/NE
binario / track 200 cm	2,4	○ bianco/white	5956/BI
		● nero/black	5956/NE
binario / track 300 cm	3,6	○ bianco/white	5957/BI
		● nero/black	5957/NE

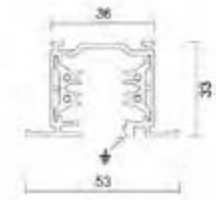

disponibile su richiesta binario ad incasso / the recessed track is available on request

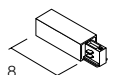
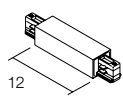
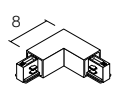
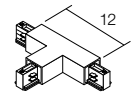
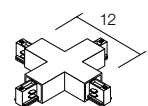

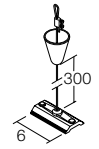

		Kg	colore/colour	codice/code
SINGOLI COMPONENTI / SINGLE COMPONENTS				
	alimentazione destra / right power supply	0,1	○ bianco/white ● nero/black	5958/BI 5958/NE
	alimentazione sinistra / left power supply	0,1	○ bianco/white ● nero/black	5959/BI 5959/NE
	giunto lineare intermedio / intermediate linear joint	0,1	○ bianco/white ● nero/black	5960/BI 5960/NE
	giunto d'angolo a L / L-angle joint	0,1	○ bianco/white ● nero/black	5961/BI 5961/NE
	giunto d'angolo a T / T-angle joint	0,1	○ bianco/white ● nero/black	5962/BI 5962/NE
	giunto a croce / cross joint	0,1	○ bianco/white ● nero/black	5963/BI 5963/NE
	testata di chiusura / terminal head	0,1	○ bianco/white ● nero/black	5964/BI 5964/NE
	cavetto di sospensione con rosone terminale hanging cable with terminal ceiling rose (3 m)	0,1	○ bianco/white ● nero/black	5965/BI 5965/NE
	supporto morsetto per attacco al soffitto ceiling connector	0,1		5967

BINARIO ELETTRIFICATO / ELECTRIFIED TRACK

48V

Un binario di piccole dimensioni, in diverse lunghezze. Sospeso o fissato al soffitto, e unito tramite giunti lineari, e ad angolo retto è possibile seguire ed illuminare percorsi e ambienti professionali con una luce d'accento o diffusa.

Predisposto per i faretti Sistema U, Grillo, S23, R23 e Cip e per i moduli a luce diffusa o UGR.

A small-sized track, in different lengths. Suspended or fixed to the ceiling, joined through linear joints, and at a 90° angle, it is possible to follow and illuminate pathways and professional environments with accent or diffused light.

Pre-arranged to fix Sistema U, Grillo, S23, R23 and Cip spotlights and modules with diffused light or UGR versions.



binario/track	Kg	colore/colour	codice/code
---------------	----	---------------	-------------

BINARIO ELETTRIFICATO A SOSPENSIONE - SOFFITTO / HANGING - CEILING ELECTRIFIED TRACK

binario / track	L100 48V	0,8	○ bianco/white	519.1J
			● nero/black	519J
binario / track	L200 48V	1,6	○ bianco/white	520.1J
			● nero/black	520J
binario / track	L300 48V	2,4	○ bianco/white	521.1J
			● nero/black	521J

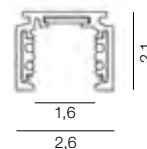

BINARIO ELETTRIFICATO A INCASSO / BUILT-IN ELECTRIFIED TRACK

binario / track	L100 48V	0,8	● nero/black	591J/NE
binario / track	L200 48V	1,6	● nero/black	592J/NE
binario / track	L300 48V	2,4	● nero/black	523J/NE

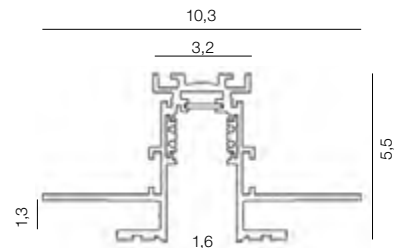

GIUNTI DI CONNESSIONE DEI BINARI / TRACK CONNECTION JOINTS

testata di chiusura / terminal head	0,01	○ bianco/white	523.1J
		● nero/black	523J
giunto lineare / linear joint	0,1	○ bianco/white	524.1J
		● nero/black	524J
giunto 90° / 90° joint	0,1	○ bianco/white	525.1J
		● nero/black	525J
giunto flessibile /flexible joint	0,1	○ bianco/white	544.1J
		● nero/black	544J

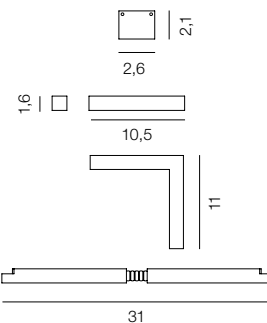

cavo di sospensione / hanging cable 1,5 m			526J
testata di alimentazione / feeding unit	0,1		522J

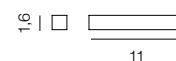

328	giunto intermedio meccanico / mechanical intermediate joint		547X
	giunto terminale meccanico / mechanical terminal joint		548X

su richiesta il binario a sospensione è disponibile con luce indiretta
on request the suspension track is also available with indirect light

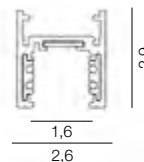



ALIMENTATORE REMOTO / REMOTE DRIVER

60W 230/48	0,5	5142.3
100W 230/48V	0,6	5142.1
200W 230/48V	1	5142.2

ROSONE CON ALIMENTATORE / CEILING ROSE WITH DRIVER

100W 230/48V	35x8 H5 cm	1,5	<input type="radio"/> bianco/white	40086/BI
			<input type="radio"/> nero/black	40086/NE
200W 230/48V	35x8 H5 cm	1,9	<input type="radio"/> bianco/white	40086.1/BI
			<input type="radio"/> nero/black	40086.1/NE

La scelta del codice del rosone è legato alla somma dei Watt dei singoli spot.
The choice of the ceiling rose code is related to the watts sum of the different spots.

BLUETOOTH  

dispositivo Casambi bluetooth per la dimmerazione indipendente di ogni singolo faretto - in abbinamento ai faretto dimmerabili - (Casambi app. iOS e Android free) 545J 
bluetooth device for an independent dimming of each individual spotlight together with dimmable spotlights (Casambi app. iOS e Android free)

dispositivo per la dimmerazione PUSH del binario elettrificato 48V 500X
da ordinare in abbinamento ai faretto dimmerabili
bluetooth device to dimmer the 48V electrified track
to be ordered together with the dimmable spotlights

MODULI per binario elettrificato 48V MODULES for 48V electrified track



Moduli da fissare al binario elettrificato, disponibili in due versioni: a luce diffusa con schermo opalino, o a luce diretta con riflettore microprismatico che aumenta l'efficienza luminosa, con UGR<19.

I moduli sono in due lunghezze e con Led nella temperatura di colore (2700-4000K), con una alta resa cromatica e con CRI>90.

Moduli in altre lunghezze, con temperatura di colore a 3000K, e orientabili su richiesta.

Modules to be fixed to the electrified track, available in two versions: diffused light with opal screen or direct light with microprismatic screen, which increases luminous efficiency, with UGR<19.

The modules are in two lengths and with Led with colour temperature (2700-4000K), with high colour rendering and CRI>90.

Modules in other lengths, with colour temperature at 3000K, and adjustable are available on request.



watt flusso/flux CCT dimension Kg colore/colour codice/code

MODULI DI LUCE LINEARE / LINEAR LIGHT MODULES

moduli con diffusore opalino / opal diffuser module

6W 48V 744lm 3000K L28,6 cm

○ bianco/white 565.1J

● nero/black 565J

29,8W 48V 3720lm 3000K L141 cm

○ bianco/white 567.1J

● nero/black 567J

moduli con diffusore UGR / UGR diffuser module

5,6W 48V 579lm 3000K L28,6 cm

○ bianco/white 566.1J

● nero/black 566J

18,2W 48V 2087lm 3000K L113 cm

○ bianco/white 597.1J

● nero/black 597J

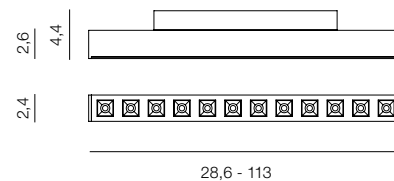
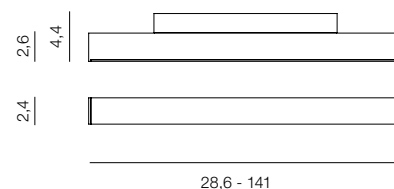

su richiesta disponibile a 2700K e 4000K e con schermo prismatico
on request also available with 2700K and 4000K and with prismatic screen

diffusore opalino / opal diffuser L28,6

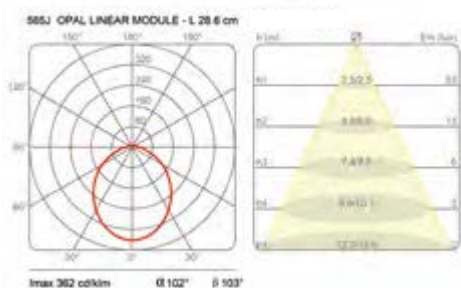

diffusore opalino / opal diffuser L141

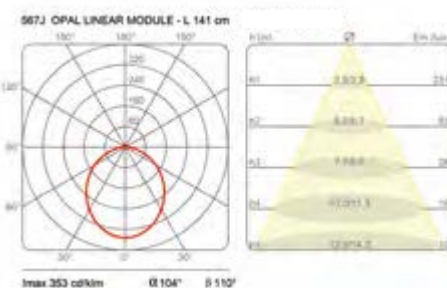

diffusore UGR / UGR diffuser L28,6

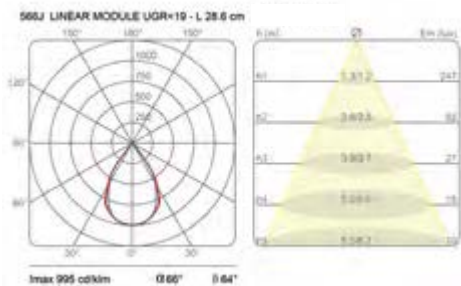

diffusore UGR / UGR diffuser L113

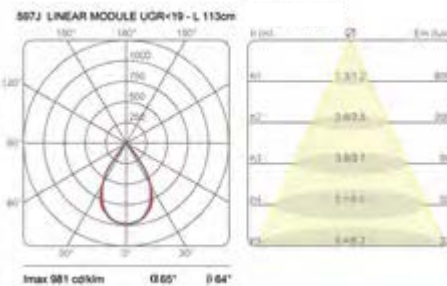



Moduli a luce diffusa o con riflettore UGR da fissare al binario.

Diffused light modules or with UGR diffuser to be fixed to the track.

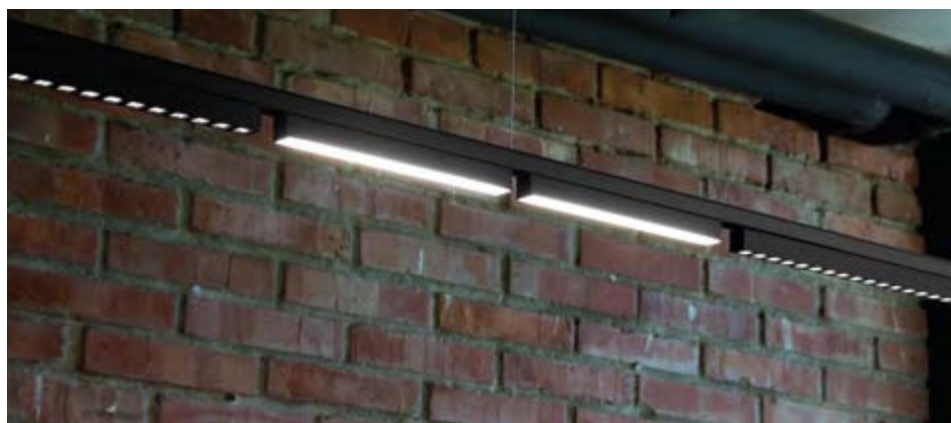

ACCESSORIO / ACCESSORY

accessorio paraluce della lunghezza dei moduli.

modulo 28,6cm	40168/GI
modulo 113cm	40168.1/GI
modulo 141cm	40168.2/GI

lens hood accessory of the modules length.

module 28.6 cm	40168/GI
module 113 cm	40168.1/GI
module 141 cm	40168.2/GI



SPOTTÒ

Un apparecchio come un proiettore teatrale di grandi dimensioni orientabile, con alette frangiluce. Una luce d'accento con una sorgente di luce a LED bianco o RGB. Con base a treppiede in metallo verniciato, nella versione da terra.

An adjustable device that recalls a large sized theater projector with anti-glare louver. An accent light with a white or RGB LED light source. With a tripod base in painted metal, in the floor version.

P. Galuzzi - S. Angiolini
C. Valli - E. Martinelli



SPOTTÒ

terra / standing

Apparecchio a luce diretta orientabile da terra con supporto girevole in metallo, regolabile in altezza e base a treppiede, verniciato nel colore nero.
Sorgente di luce a LED integrata.
Completo di alimentatore elettronico con alette frangiluce e telecomando.

Adjustable direct floor device with height-adjustable metal swivel base and tripod base, painted black.
Integrated LED light source.
Complete of electronic driver with anti-glare louver flaps and remote control.

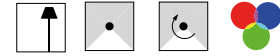

watt	flusso/flux	CCT	Kg	colore/colour	codice/code
------	-------------	-----	----	---------------	-------------

SPOTTÒ

30W 230V	4000lm	3000K	15	● nero/black	2277/L/1/NE
----------	--------	-------	----	--------------	-------------

dimmerabile e con telecomando / dimmable and with remote control

SPOTTÒ RGBW

44W RGB 230V	4.676lm		15	● nero/black	2277/L/NE
--------------	---------	--	----	--------------	-----------

dimmerabile e con telecomando / dimmable and with remote control

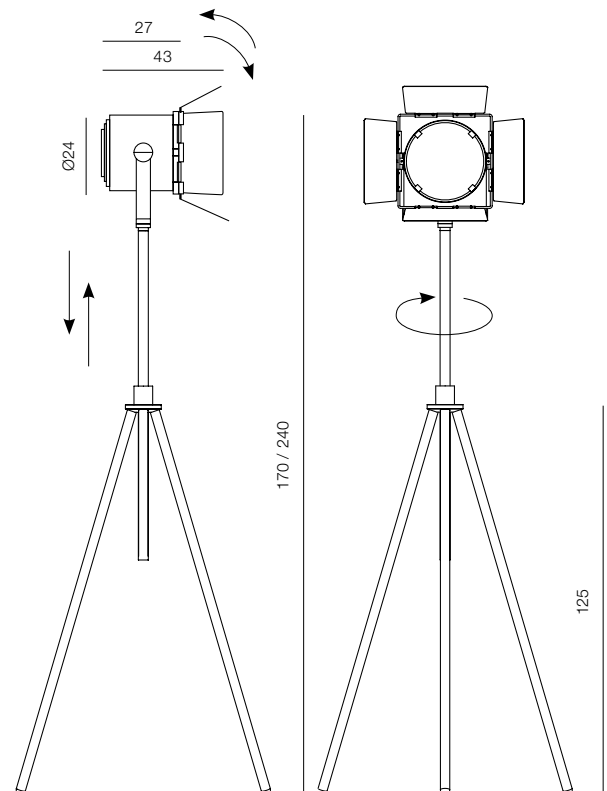



2003

Essenziale nel design che ne esalta la funzionalità.

Due forme geometriche, un cilindro e una parabola collegati al dissipatore formano una grande sospensione a luce diretta e indiretta con sorgente di luce a LED. Un apparecchio a sospensione per un'illuminazione generale da installare in grandi ambienti interni.

Essential design that highlights its functionality. Two geometric shapes, a cylinder and a parabola connected to the heat sink give life to a large direct and indirect light pendant lamp with LED light source.

A suspension light fixture for a general lighting, to be installed in large internal areas.

Elio e Emiliana Martinelli







2003

Apparecchio a sospensione a luce diretta/ indiretta. Struttura in alluminio verniciato, particolari in resina nel colore nero. Sorgente di luce a LED integrata. Alimentatore dimmerabile integrato nel corpo della lampada. Dissipatore a vista. Sospeso con tigi in acciaio.

Suspension device, direct and indirect light, grey aluminium structure, black resin details. Integrated LED light source. Integrated dimmable driver inside the body lamp. Visible heatsink. Suspended with steel rods.

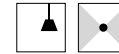

watt	flusso/flux	CCT	Kg	colore/colour	codice/code
luce diretta / direct light 55W 230V	7000lm	3000K	12	● antracite/anthracite	2003/50/DIM/L/1/AN
luce indiretta / indirect light 38W 230V	4000lm	3000K			

alimentatori elettronici dimmerabili / electronic dimmable drivers

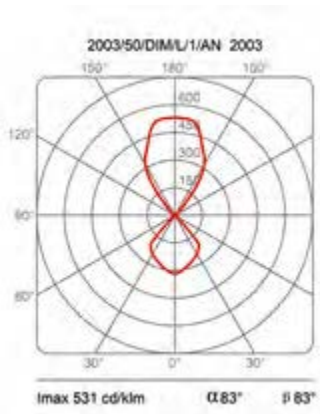
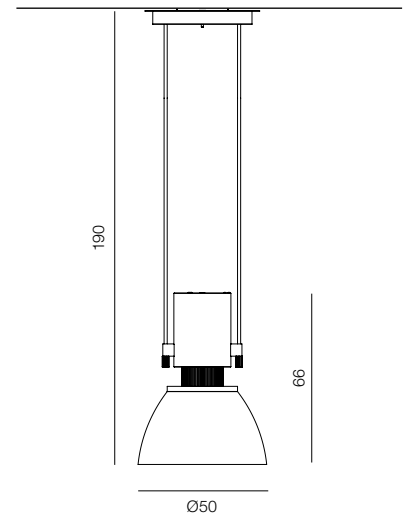
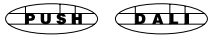



CONDOR

Un supporto in metallo verniciato nel colore rosso fuoco sostiene il dissipatore e una grande parabola. Pensata per grandi spazi espositivi e commerciali. Condor vola alto ed illumina con una elevata efficienza. Disponibile in due diversi diametri.

A metal support painted in flaming red color hold up the heat sink and a large parabola. Designed for large exhibition and commercial environments. Condor flies high and lights up thanks to its high efficiency. Available in two different diameters.

Emiliana Martinelli







STARBUCKS



CONDOR

Apparecchio a sospensione a luce diretta.
 Struttura in alluminio nel colore antracite.
 Particolare supporto in alluminio verniciato nel colore rosso.
 Sorgente di luce a LED ad alta efficienza.
 Alimentatore elettronico integrato nel rosone al soffitto.
 Disponibili in due dimensioni.

Direct light suspension device.
 Anthracite aluminium structure.
 Special red lacquered aluminium support.
 High efficiency LED light source.
 Driver integrated in the ceiling rose.
 Available in two dimension.



watt	flusso/flux	CCT	Kg	colore/colour	codice/code
<hr/>					
CONDOR Ø42					
40W 230V	4600lm	3000K	7	● antracite/anthracite	2085/J/DIM/L/1/AN
<hr/>					
CONDOR Ø50					
60W 230V	7000lm	3000K	7	● antracite/anthracite	2085/DIM/L/1/AN

rosone con alimentatore dimmerabile / ceiling rose with dimmable driver Ø 23 H 5,5

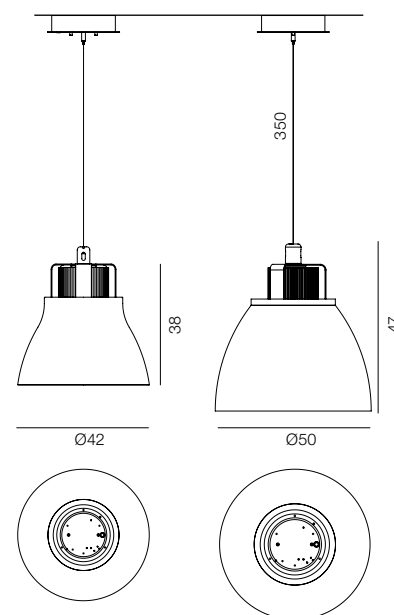

Su richiesta il supporto rosso può essere verniciato in altri colori
 On request the red support can be painted with another colors

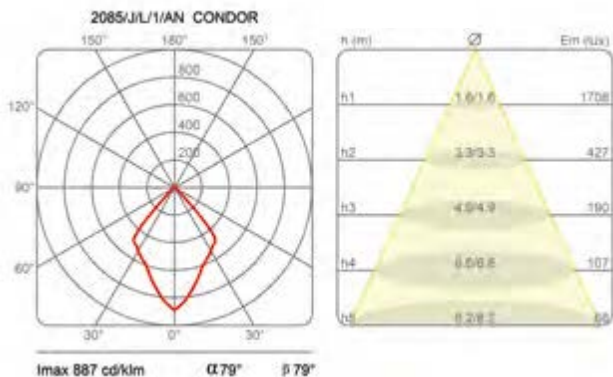



Studio Andreas Oliver Klein, Pietrasanta – LU

NUVOLE VAGABONDE

Una serie di elementi in metacrilato opal bianco, sovrapposti e sfalsati, fissati ad incastro ad una struttura portante in metallo definiscono il volume della lampada e diffondono la luce ridisegnando con le ombre la loro forma. Disponibile in due dimensioni per adattarsi al tuo spazio.

A series of overlapping and staggered elements in white opal methacrylate fixed in interlocked to a supporting metal structure define the lamp volume and diffuse light, redesigning their shape through shadows. Available in two sizes to easily fit your space.

Elio e Emiliana Martinelli







NUVOLE VAGABONDE

Lampada a sospensione a luce diffusa.
 Struttura in metallo, elementi diffusori sovrapposti in metacrilato opal bianco e in policarbonato opal bianco nella versione junior.
 Sospesa con cavi in acciaio fissati al rosone al soffitto. Per lampadine a LED.
 Disponibile in due misure.

Suspension lamp with diffused light. Metal structure, diffusing superimposed elements in white opal methacrylate and white opal polycarbonate in the junior version.
 Fixed with steel cable to the ceiling rose.
 For LED bulbs.
 Available in two sizes.

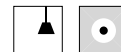

watt	CCT	Kg	colore/colour	codice/code
3x15W E27 230V	3000K	10	○ bianco/white	2011/80/L/1/BI

su richiesta / on request

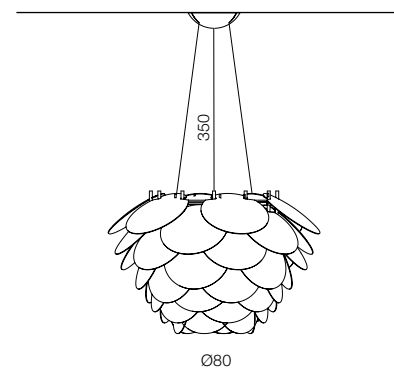

1x15W E27 230V	3000K	3,5	○ bianco/white	2011J
----------------	-------	-----	----------------	-------

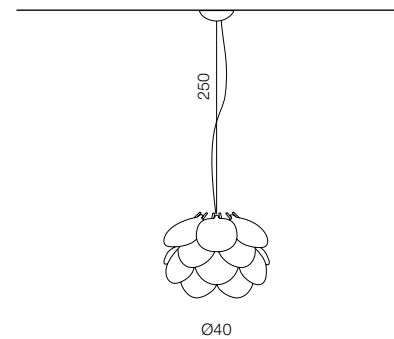



SOUND

Un apparecchio lineare a luce diretta diffusa, per sorgente di luce a LED. Per uffici, scuole e spazi che richiedono efficienza luminosa ed un elevato comfort. Struttura in alluminio, con un particolare schermo prismatico per il controllo dell'abbagliamento.

A linear device with diffused direct light, for LED light source. Ideal for offices, schools and spaces requiring a particular luminous efficiency and a high level of comfort. Aluminium structure with a special prismatic anti-glare screen.

Emiliana Martinelli







SOUND



Lampada a sospensione a luce diretta diffusa. Struttura in alluminio verniciato nel colore grigio con pomelli e particolari nel colore grigio scuro. Diffusore trasparente prismatico antiabbagliamento. Sorgente di luce a LED integrata e alimentatori elettronici dimmerabili inseriti all'interno del corpo lampada.

Suspended lamp with direct and diffused light. Grey lacquered aluminium structure, dark grey lacquered knobs. Anti-glare prismatical and transparent diffuser. Integrated LED light source and dimmable electronic drivers placed inside the body lamp.



UGR<19

watt	flusso/flux	CCT	Kg	colore/colour	codice/code
37W 230V	6000lm	3000K	5,5	● grigio-grigio scuro grey-dark grey	2098/DIM/L/1/GR

rosone / ceiling rose Ø10 H3
alimentatori elettronici dimmerabili / electronic dimmable drivers

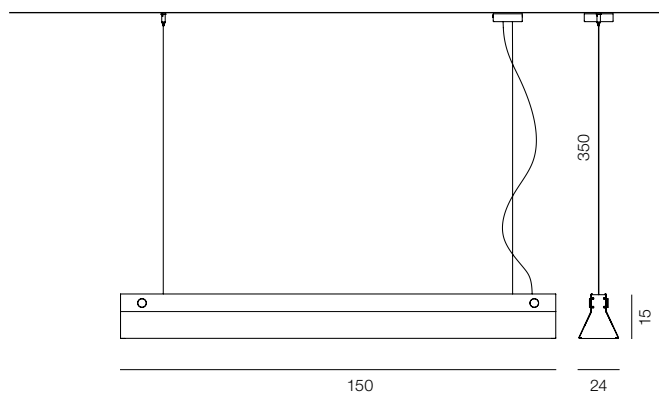
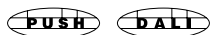

a richiesta è possibile realizzare il corpo lampada e i pomelli in altri colori
on request it is possible to made the body lamp and the knobs in other colors

358

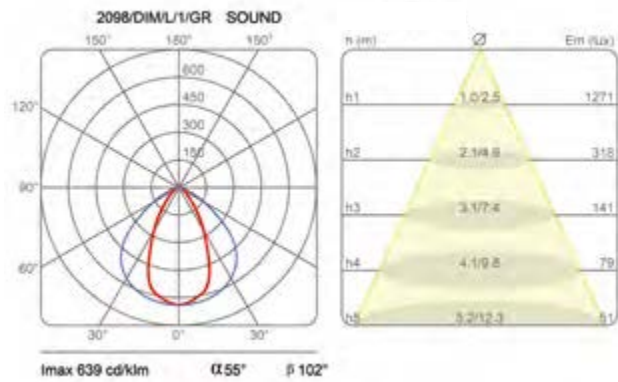



CORONA

Una lampada rotonda, minimalista per sorgente di luce a LED ad alta efficienza luminosa.

Una luce diretta, per l'installazione a soffitto o parete.

Si integra nell'ambiente nelle diverse situazioni, sia in ambito residenziale che professionale.

A round minimalist lamp for LED light source with a high luminous efficiency. A direct LED light to be mounted to the ceiling or wall. The lamp integrates into the environment in various situations both in residential and professional settings.

Emiliana Martinelli



CORONA

Lampada da parete o soffitto a luce diffusa. Diffusore in metacrilato opal bianco, base in alluminio verniciato nel colore bianco, disco centrale in metacrilato iridescente, bottone di bloccaggio in metallo verniciato. Sorgente di luce a LED integrato completo di alimentatore elettronico. Disponibile in due misure.

Wall or ceiling lamp, diffused light. Diffuser in white opal methacrylate. Base in white painted aluminium, central disc made of iridescent methacrylate, central button in painted metal. LED light source integrated, equipped with electronic driver. Available in two sizes.

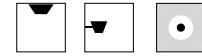

watt	flusso/flux	CCT	Kg	colore/colour	codice/code
------	-------------	-----	----	---------------	-------------

CORONA Ø 42

26W 230V	3200lm	3000K	4,5	○ bianco/white	2834/M/L/1
----------	--------	-------	-----	----------------	------------

alimentatore elettronico dimmerabile / dimmable electronic driver.

CORONA Ø 28

15W 230V	1500lm	3000K	2,5	○ bianco/white	2834/M/J/L/1
----------	--------	-------	-----	----------------	--------------

alimentatore elettronico dimmerabile / dimmable electronic driver.

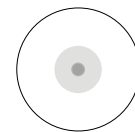
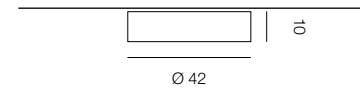

2834/M/L/1

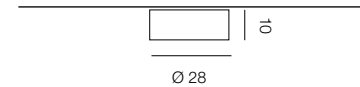

2834/M/J/L/1



*"Di vita, di poesia, di vino, o di virtù,
a piacer vostro. Ma inebriatevi!,,*

Charles Baudelaire



OLYMPIC

Una struttura in metallo verniciato con un forte aggetto, un dissipatore a vista che sorregge il grande diffusore in vetro satinato, formano la lampada. Un'illuminazione diffusa con sorgente di luce a LED per spazi residenziali, commerciali e zone di ricevimento.

The lamp is made up of a fixture in painted metal with a strong overhang, a visible heat sink in full view that supports the large satin glass diffuser. A diffused lighting with LED light source for residential, commercial and reception areas.

Elio e Emiliana Martinelli



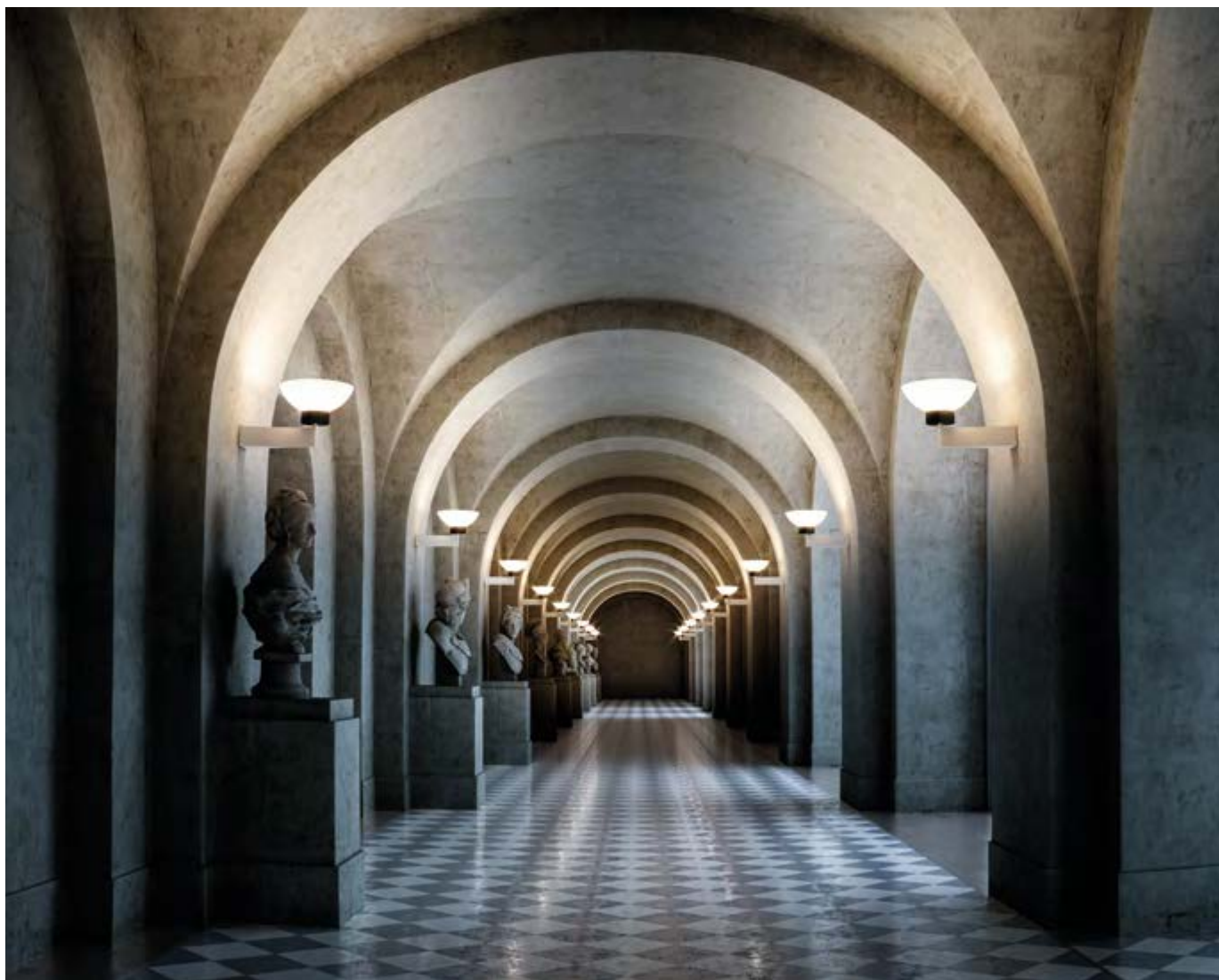



OLYMPIC

Lampada da parete a luce diffusa.
 Struttura in metallo verniciato, dissipatore
 in alluminio a vista che garantisce il
 raffreddamento della sorgente di luce a LED,
 diffusore in vetro satinato.
 Alimentatore elettronico dimmerabile integrato.

Wall lamp with diffused light.
 Metal painted structure, visible aluminium heat
 sink that guarantees led light source cooling,
 satin glass diffuser.
 Dimmable electronic driver.



watt	flusso/flux	CCT	Kg	colore/colour	codice/code
30W 230V	3900lm	3000K	5,6	○ bianco/white	1290/DIM/L/1/BI
				● antracite/anthracite	1290/DIM/L/1/AN

alimentatore elettronico dimmerabile integrato nel corpo lampada
 electronic dimmable driver integrated in the body lamp

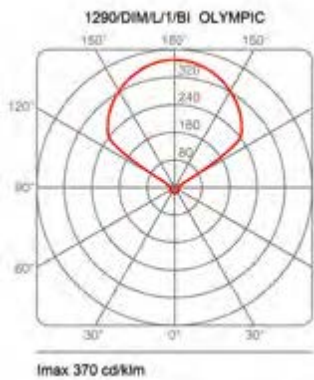
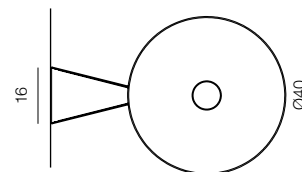
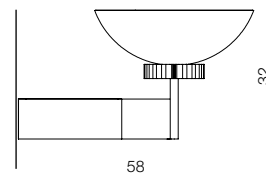



BRICK

Un estruso di alluminio a sezione rettangolare supporta moduli con luce Led orientabili.
Disponibile nelle versioni da parete e da terra. Il sistema può soddisfare svariate esigenze d'illuminazione in contesti residenziali, commerciali e espositivi.

An extruded aluminium element with a rectangular section supports the adjustable LED light modules.
Available for both wall and floor versions. The system easily meets different lighting needs in residential, commercial and exhibition contexts.

Emiliana Martinelli







BRICK

parete / wall

Lampada da parete a luce diretta, orientabile.
Struttura e base girevole in alluminio verniciato.
Completo di alimentatore elettronico.
Sorgente di luce a LED, disponibile con tre diversi fasci di luce.

Wall adjustable lamp with adjustable direct light.
Adjustable painted aluminium structure and base. Driver included in the body lamp.
LED light source, available with three different light beams.



watt	fascio/beam	flusso/flux	CCT	Kg	colore/colour	codice/code
25W 230V	medium 24° wide 36°	3150lm	3000K	1,5	○ bianco/white	1396/S/L/1/Q1/BI
					○ bianco/white	1396/S/L/1/R/BI

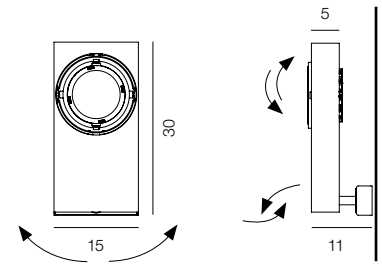

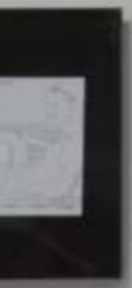

BRICK

terra / standing

Apparecchio da terra girevole a luce diretta orientabile predisposto per 2 moduli LED integrati. Struttura in alluminio verniciato girevole sulla base.
Alimentatore elettronico integrato nel corpo lampada.
Sorgente di luce a LED, disponibile con diversi fasci di luce.

Swivel standing device with direct adjustable lights for two integrated LED light source modules.
Painted aluminium structure, swivel on its base.
Complete of electronic driver.
LED light source, available with different light beams.



watt	fascio/beam	flusso/flux	CCT	Kg	colore/colour	codice/code
2x25W 230V	medium 24°	2x2023lm	3000K	14	○ bianco/white	2275/2/L/1/Q1/BI
					● nero/black	2275/2/L/1/Q1/NE
	wide 36°				○ bianco/white	2275/2/L/1/R/BI
					● nero/black	2275/2/L/1/R/NE

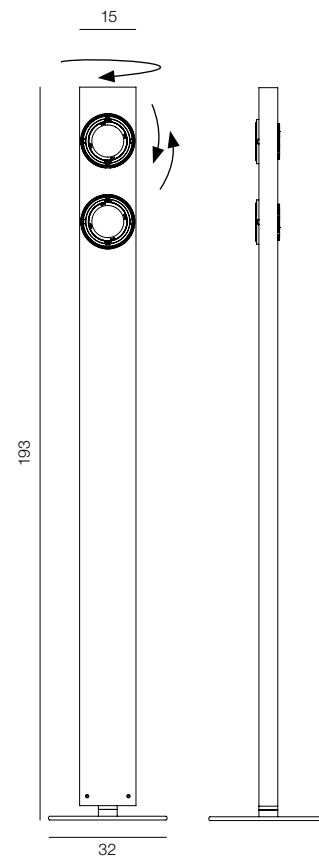



EYE

Una serie di apparecchi componibili per l'installazione a soffitto. Semplici cilindri nella versione singola, o uniti con moduli di collegamento di varie lunghezze per ottenere svariate configurazioni. Per sorgente di luce a LED orientabile per una luce d'accento, con due diversi fasci luminosi, per adattarsi alle diverse situazioni sia in spazi pubblici che residenziali.

A series of modular devices for ceiling installation.

Simple cylinders in the single version, or joined with connection modules of various lengths in order to obtain different configurations. Adjustable LED light source with two light beam angles, adaptable to many different situations both in public and residential environments.

Emiliana Martinelli







EYE

soffitto / ceiling

Apparecchio da soffitto componibile.
Sorgente a LED a luce diretta orientabile
con diverse aperture del fascio luminoso.
Composto da moduli cilindrici in alluminio
verniciato e da giunti di connessione di
varie lunghezze per il passaggio del cavo di
alimentazione.
Alimentatore elettronico integrato.

Modular ceiling lamp.
Adjustable and direct LED light source with
different beam angles. Composed of a painted
aluminium cylinder module and connection
joints of various lengths for the passage of the
power cable.
Integrated electronic driver.



watt	fascio/beam	flusso/flux	CCT	Kg	colore/colour	codice/code
EYE modulo singolo / singular module						
11W 230V	medium	1500lm	3000K	1	○ bianco/white	2876/1/L/1/24/BI
					● nero/black	2876/1/L/1/24/NE
	wide				○ bianco/white	2876/1/L/1/35/BI
					● nero/black	2876/1/L/1/35/NE
EYE predisposto per 1 giunto di collegamento / suitable for 1 connection joint						
11W 230V	medium	1500lm	3000K	1	○ bianco/white	40148/24/BI
					● nero/black	40148/24/NE
	wide				○ bianco/white	40148/35/BI
					● nero/black	40148/35/NE
EYE predisposto per 2 giunti di collegamento / suitable for 2 connection joints (180°)						
11W 230V	medium	1500lm	3000K	1	○ bianco/white	40149/24/BI
					● nero/black	40149/24/NE
	wide				○ bianco/white	40149/35/BI
					● nero/black	40149/35/NE
EYE predisposto per 2 giunti di collegamento / suitable for 2 connection joints (90°)						
11W 230V	narrow	1500lm	3000K	1	○ bianco/white	40152/24/BI
					● nero/black	40152/24/NE
	wide				○ bianco/white	40152/35/BI
					● nero/black	40152/35/NE
EYE predisposto per 3 giunti di collegamento / suitable for 3 connection joints (T)						
11W 230V	medium	1500lm	3000K	1	○ bianco/white	40150/24/BI
					● nero/black	40150/24/NE
	wide				○ bianco/white	40150/35/BI
					● nero/black	40150/35/NE
EYE predisposto per 4 giunti di collegamento / suitable for 4 connection joints (cross)						
11W 230V	medium	1500lm	3000K	1	○ bianco/white	40151/24/BI
					● nero/black	40151/24/NE
	wide				○ bianco/white	40151/35/BI
					● nero/black	40151/35/NE

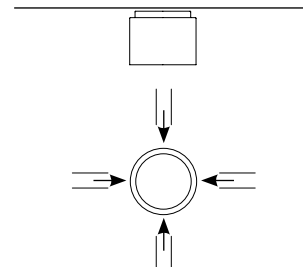
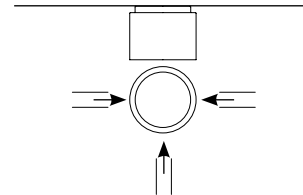
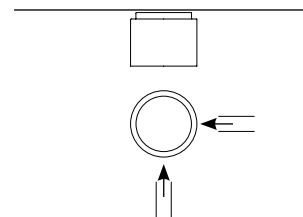
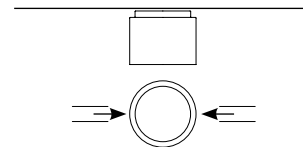
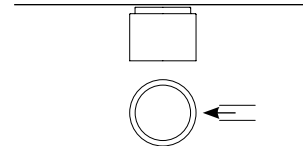
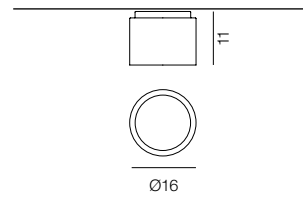

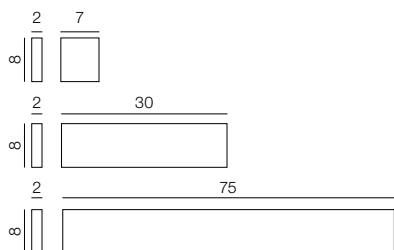
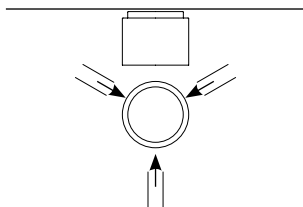
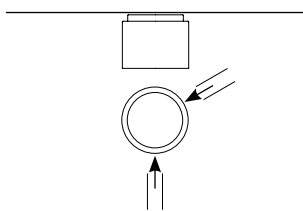

watt	fascio/beam	flusso/flux	CCT	Kg	colore/colour	codice/code
EYE predisposto per 2 giunti di collegamento / suitable for 2 connection joints (120°)						
11W 230V	medium	1500lm	3000K	1	○ bianco/white	40153/24/BI
					● nero/black	40153/24/NE
	wide				○ bianco/white	40153/35/BI
					● nero/black	40153/35/NE
EYE predisposto per 3 giunti di collegamento / suitable for 3 connection joints (120°)						
11W 230V	medium	1500lm	3000K	1	○ bianco/white	40154/24/BI
					● nero/black	40154/24/NE
	wide				○ bianco/white	40154/35/BI
					● nero/black	40154/35/NE

GIUNTI DI COLLEGAMENTO / CONNECTION JOINTS		
giunto / joint 7cm	○ bianco/white	40155/BI
	● nero/black	40155/NE
giunto / joint 30cm	○ bianco/white	40156/BI
	● nero/black	40156/NE
giunto / joint 75cm	○ bianco/white	40157/BI
	● nero/black	40157/NE

EYE

incasso / recessed

Apparecchio da incasso per sorgente di luce a LED orientabile, per una illuminazione d'accento efficace e versatile. Di facile installazione e buona integrazione nel controsoffitto.
Con diverse aperture del fascio luminoso. Alimentatore remoto.

Recessed, adjustable light device. LED light source, for an effective and versatile accentuated lighting.
Easy to fix, with a full integration in a false ceiling.
With different light beam angles. Remote driver.



watt	fascio/beam	flusso/flux	CCT	Kg	colore/colour	codice/code
11W 230V	medium	1500lm	3000K	1	○ bianco/white	2882/L/1/MS/BI
	wide				○ bianco/white	2882/L/1/R/BI

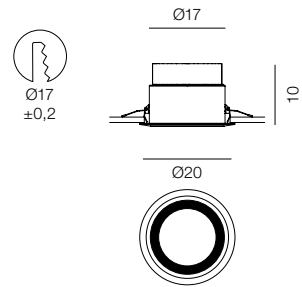

alimentatore elettronico incluso da inserire nel controsoffitto
electronic driver included to be placed inside the false ceiling



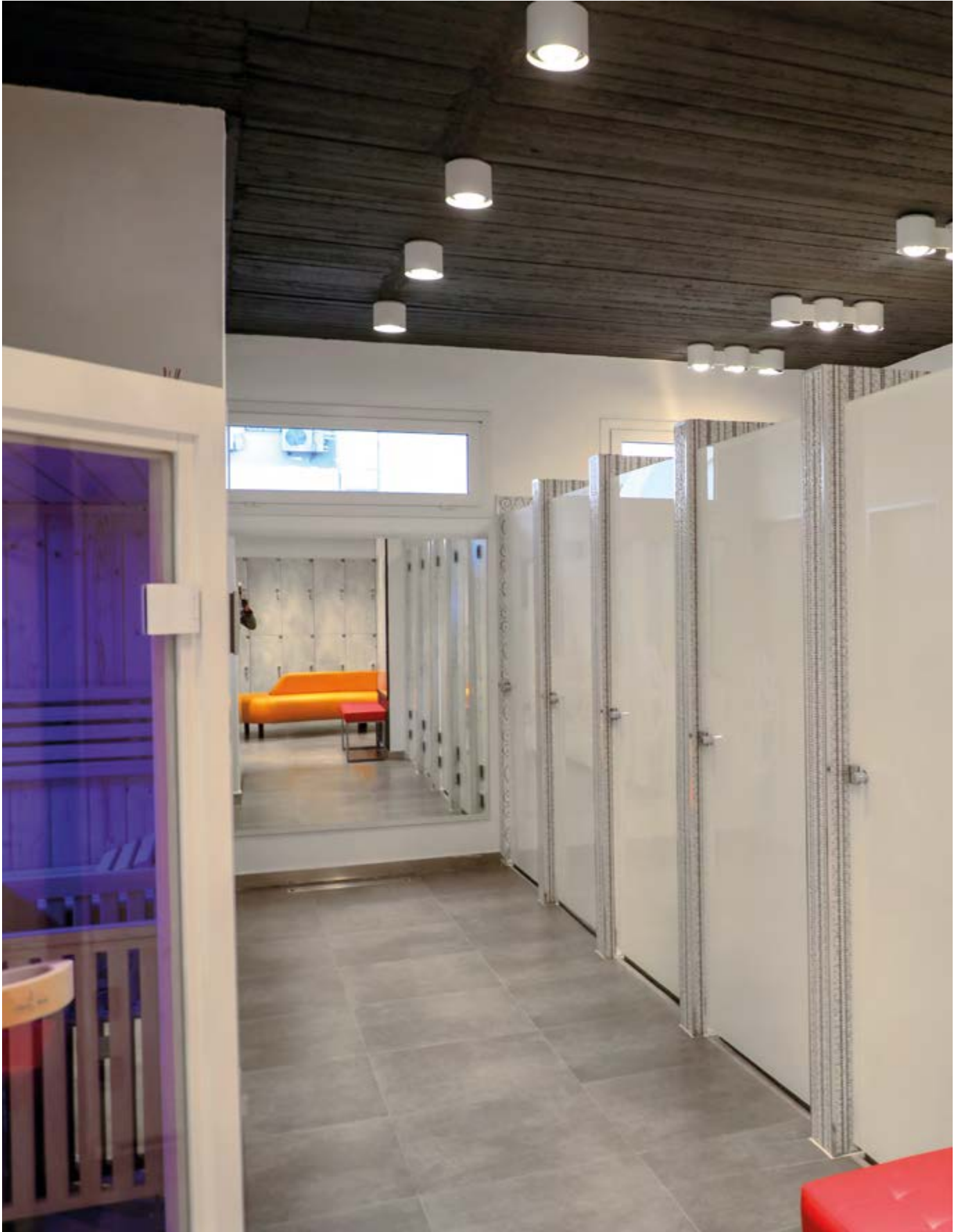



Martinelli Luce presenta una serie di lampade per esterno frutto di una ricerca di diverse soluzioni per illuminare gli spazi aperti.

Lampade pensate per valorizzare con la luce particolari angoli del giardino o del terrazzo, illuminare percorsi, esaltare cespugli o alberi ma anche gli elementi architettonici, in modo discreto ed a volte giocoso.

Lampade nate sia dallo studio di progettazione interno all'azienda, sia dalla collaborazione con designer esterni in base a una ricerca funzionale, tecnologica ed estetica e con un design che identifica il nostro marchio da molto tempo.

Martinelli Luce presents a series of lamps for outdoors, the result of research into different solutions for lighting open spaces.

Lamps designed to enhance with light particular corners of the garden or terrace, illuminate paths, enhance bushes or trees but also architectural elements, in a discreet and sometimes playful way.

Lamps created both by the company's in-house design studio and in collaboration with external designers on the basis of functional, technological and aesthetic research and with a design that has long identified our brand.

LADY GALALA

Lady Galala è una sospensione composta da un corpo interno che unisce tre diversi diffusori di forma conica di diversi diametri e tonalità di colori, che ricordano il sole e il mare, il giallo e l'arancio, come la luce al tramonto che si riflette in mille sfumature sulla sabbia; il blu e il bianco, come la spuma del mare creata dalle onde. Questa lampada può assumere quindi molte configurazioni, colore-forma, cambiando con semplicità il suo aspetto.

Come un gioco per bambini.

Lady Galala is a suspension lamp consisting of an interior body that combines three different conical-shaped diffusers of different diameters and shades of colour, that recall the sun and the sea: yellow and orange, like the light at sunset reflected in a thousand shades on the sand; blue and white, like the foam of the sea created by the waves. This lamp can therefore assume many configurations, colour-shapes, changing easily its appearance. Like a child's game.

Peluffo&Partners











LADY GALALA

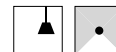

Lampada componibile a sospensione a luce diretta composta da 3 diversi diffusori in metacrilato satinato in 4 colori e da un supporto interno con schermo in vetro satinato predisposto per lampadina a LED. Combinando i diffusori di forma e colori diversi si ottengono varie configurazioni (vedi esempi). Disponibile anche la versione da interno.

Modular direct light suspension lamp consisting of 3 different satin-finish methacrylate diffusers in 4 colours and an internal support with a satin glass inner screen for a LED bulb. By combining diffusers of different shapes and colours, various configurations can be obtained (see examples). Also available in an indoor version.



watt	flusso/flux	CCT	Kg	colore/colour	codice/code
12W E27	1350lm		1,5	○ bianco/white	40171.1/BI
				● nero/black	40171.1/NE

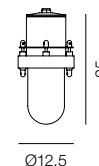

DIFFUSORI / DIFFUSERS

diffusore / diffuser 1	0,3	○ bianco/white	40172.1/BI
		● giallo / yellow	40172.1/GI
		● arancio / orange	40172.1/AR
		● blu / blue	40172.1/BL

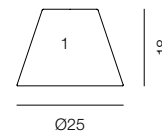

diffusore / diffuser 2	0,4	○ bianco/white	40173.1/BI
		● giallo / yellow	40173.1/GI
		● arancio / orange	40173.1/AR
		● blu / blue	40173.1/BL

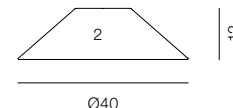

diffusore / diffuser 3	1	○ bianco/white	40174.1/BI
		● giallo / yellow	40174.1/GI
		● arancio / orange	40174.1/AR
		● blu / blue	40174.1/BL

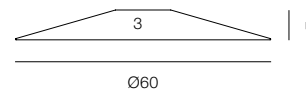

396

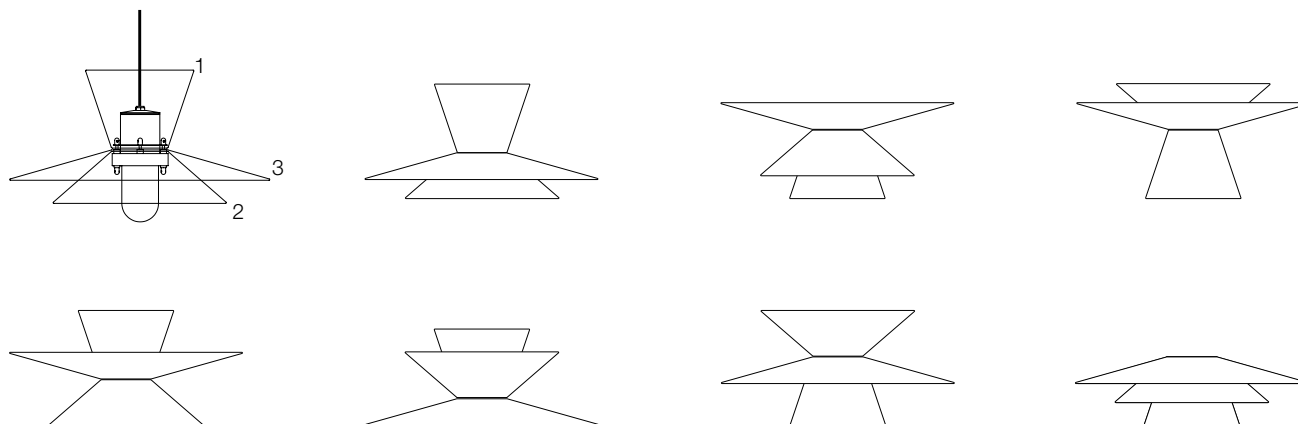



AMANITA

Una lampada per outdoor dal forte carattere, Amanita si ispira alla forma del fungo omonimo. Una solida forma in cemento, da fissare a terra, resa lieve dalla sua luce calda, morbida e soffusa, per illuminare un prato, un viale, un percorso e creare un'atmosfera nel giardino.

An outdoor lamp with a strong character, Amanita is inspired by the shape of the homonymous mushroom. A solid shape in concrete, to be fixed to the ground, softened by its warm, smooth and suffused light, to illuminate a lawn, a path and to create atmosphere in the garden.

Emiliana Martinelli







AMANITA

Lampada da esterno realizzata in cemento ad alta resistenza e idrorepellente nel colore grigio cemento. Il diffusore inferiore del cappello è in policarbonato satinato per diffondere la luce della sorgente di luce a LED.
Alimentatore integrato. Supporto di base interno in metallo per il bloccaggio e fissaggio della lampada sul calcestruzzo.

Outdoor lamp made of highly resistant and water-repellent concrete in cement grey colour. The lower diffuser of the cap is in satin polycarbonate to diffuse the light of the LED light source. Integrated driver.
Internal metal base support for locking and fixing the lamp to the concrete.

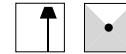

IP65

watt	flusso/flux	CCT	Kg	colore/colour	codice/code
14W 230V	1900lm	2700K	17	● grigio cemento/concrete grey	2311/GR

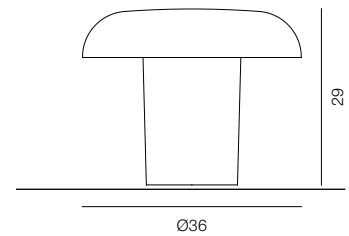



FROG

Una luce d'accento, orientabile, mobile per outdoor. La puoi semplicemente appoggiare a terra e illuminare con i suoi diversi fasci di luce una siepe, un grande albero, un angolo del tuo giardino e anche una scultura. Ma puoi fissarlo anche con un picchetto a terra. Frog è utile, funzionale, divertente.

An adjustable, movable, accent light for outdoor use. You can simply place it on the ground and illuminate with its various beams of light, a hedge, a large tree, a corner of your garden and even a sculpture. But you can also fix it with a peg on the ground. Frog is useful, functional, fun.

Emiliana Martinelli











FROG

terra / ground

Lampada da esterno a luce diretta orientabile. Da spostare liberamente grazie alla base di appoggio in alluminio verniciato nel colore nero. Corpo lampada stampato con tecnologia rotazionale in polietilene nei colori: blu ottanio, giallo, arancio e antracite. Per lampadina a LED. Disponibile picchetto per fissare la lampada nel prato.

Outdoor lamp with adjustable direct light. It can be moved easily thanks to its black painted aluminium base. Body lamp moulded in polyethylene with rotational technology in octane blue, yellow, orange or anthracite colour. For LED bulb. A peg is available to fix the lamp in the lawn.



IP65

watt fascio/beam flusso/flux CCT Kg colore/colour codice/code

FROG con base di appoggio / with base

20W	230V	E27	PAR38	45°	1910lm	3000K	2	● blu/blue	2309/BL
								● giallo/yellow	2309/GI
								● arancio/orange	2309/AR
								● antracite/anthracite	2309/AN

cavo di alimentazione e spina / power cable and plug 5m

picchetto per fissaggio a terra / peg for ground fixing (optional)

40166

LAMPADINE / BULBS

20W	E27	PAR38	45°	1910lm	3000K	510X
14W	E27	PAR38	75°	1400lm	3000K	511X

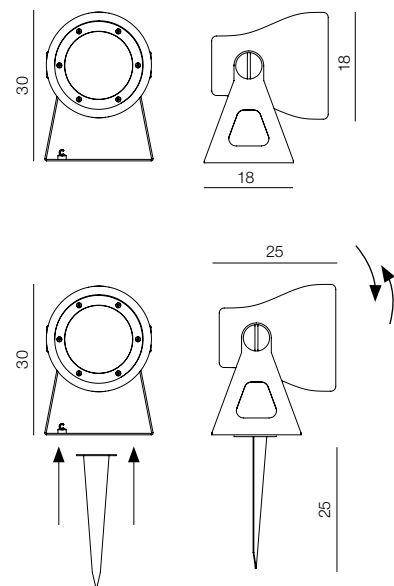

 LAMPADINA RGB-W / RGB-W BULB

20W E27 PAR38 45° RGB-W 513Y

con telecomando / with remote control

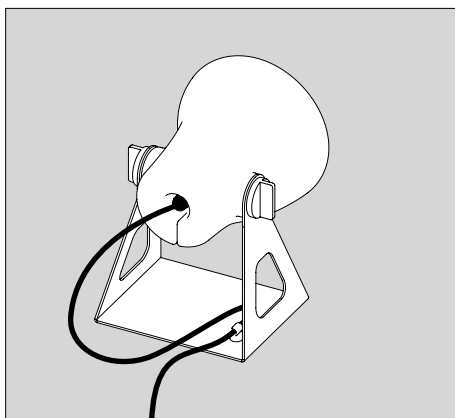



FROG





parete / wall

Lampada da esterno a luce diretta orientabile.
 Con base di appoggio da fissare a parete in alluminio verniciato nel colore nero.
 Corpo lampada stampato con tecnologia rotazionale in polietilene nei colori: blu ottanio, giallo, arancio e nero.
 Per lampadina a LED.

Outdoor lamp with adjustable direct light.
 With black painted aluminium base to be fixed to the wall.
 Body lamp moulded in polyethylene with rotational technology. Available in: octane blue, yellow, orange or anthracite colour.
 For LED bulb.



IP65

watt	fascio/beam	flusso/flux	CCT	Kg	colore/colour	codice/code
20W E27 PAR38 230V	45°	1910lm	3000K	2	 blu/blue	1453/BL
					 giallo/yellow	1453/GI
					 arancio/orange	1453/AR
					 antracite/anthracite	1453/AN

LAMPADINE / BULBS

20W E27 PAR38	45°	1910lm	3000K		510X
14W E27 PAR38	75°	1400lm	3000K		511X



LAMPADINA RGB-W / RGB-W BULB

20W E27 PAR38	45°		RGB-W		513Y
---------------	-----	--	-------	--	------

con telecomando / with remote control

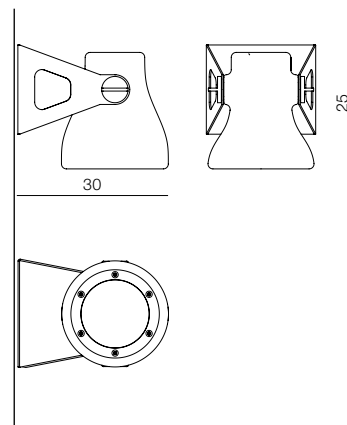



MINIFROG

Minifrog amplia la famiglia della lampada da esterni Frog come variante in scala ridotta.

Questa nuova versione permette di posizionarli nel giardino creando così un'ambientazione più misteriosa.

Spostare Minifrog è ancora più facile perché più leggera ed il minor ingombro permette di utilizzarla anche su un piccolo terrazzo.

Minifrog è stata pensata come un punto luce discreto, ma divertente grazie alla gamma di colori proposti.

Minifrog increases the Frog outdoor lamp family as a scaled-down variant.

This new version allows them to be placed in the garden, creating a more mysterious ambience.

Moving Minifrog is even easier because it is lighter and its smaller size allows it to be used even on a small terrace.

Minifrog is designed as a discreet, yet fun light point thanks to the range of colours on offer.

Emiliana Martinelli







MINIFROG

terra / ground



Un piccolo spot da esterno a luce diretta orientabile. Da spostare liberamente grazie alla base di appoggio in alluminio verniciato nel colore nero. Corpo lampada stampato con tecnologia rotazionale in polietilene nei colori: blu ottanio, giallo, arancio e antracite. Per lampadina a LED. Disponibile picchetto per fissare la lampada nel prato.

Outdoor Little spot with adjustable direct light. It can be moved easily thanks to its black painted aluminium base. Body lamp moulded in polyethylene with rotational technology in octane blue, yellow, orange or anthracite colour. For LED bulb. A peg is available to fix the lamp in the lawn.



IP65

watt	fascio/beam	flusso/flux	CCT	Kg	colore/colour	codice/code
------	-------------	-------------	-----	----	---------------	-------------

MINIFROG con base di appoggio / with base

7W GU10 230V	60°			0,5	blu/blue	2309/J/BL
					giallo/yellow	2309/J/GI
					arancio/orange	2309/J/AR

Ø 11

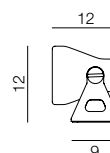

cavo di alimentazione e spina / power cable and plug 5m

picchetto per fissaggio a terra / peg for ground fixing (optional)	40192
--	-------



LAMPADINE / BULBS

7W GU10	60°	610lm	2700K	541Y
4,5W GU10	38°	355lm	2700K	542Y

(misure lampadina/bulb size Ø 50 H56)



BRUCO

Una famiglia di lampade componibili a luce diretta per esterno, da fissare a terra o a parete.

Una testa con sorgente di luce LED sovrapponibile, con diverse posizioni di orientamento, fissata a un palo di varie altezze compongono, secondo le tue necessità, il Bruco.

A family of modular lamps with direct light for outdoor to be fixed to the ground or to the wall.

A pole of different heights of your choice, with a head composed of an overlapping LED light source, that you can fix with a different orientation, according to your needs.

Studio Natural







BRUCO

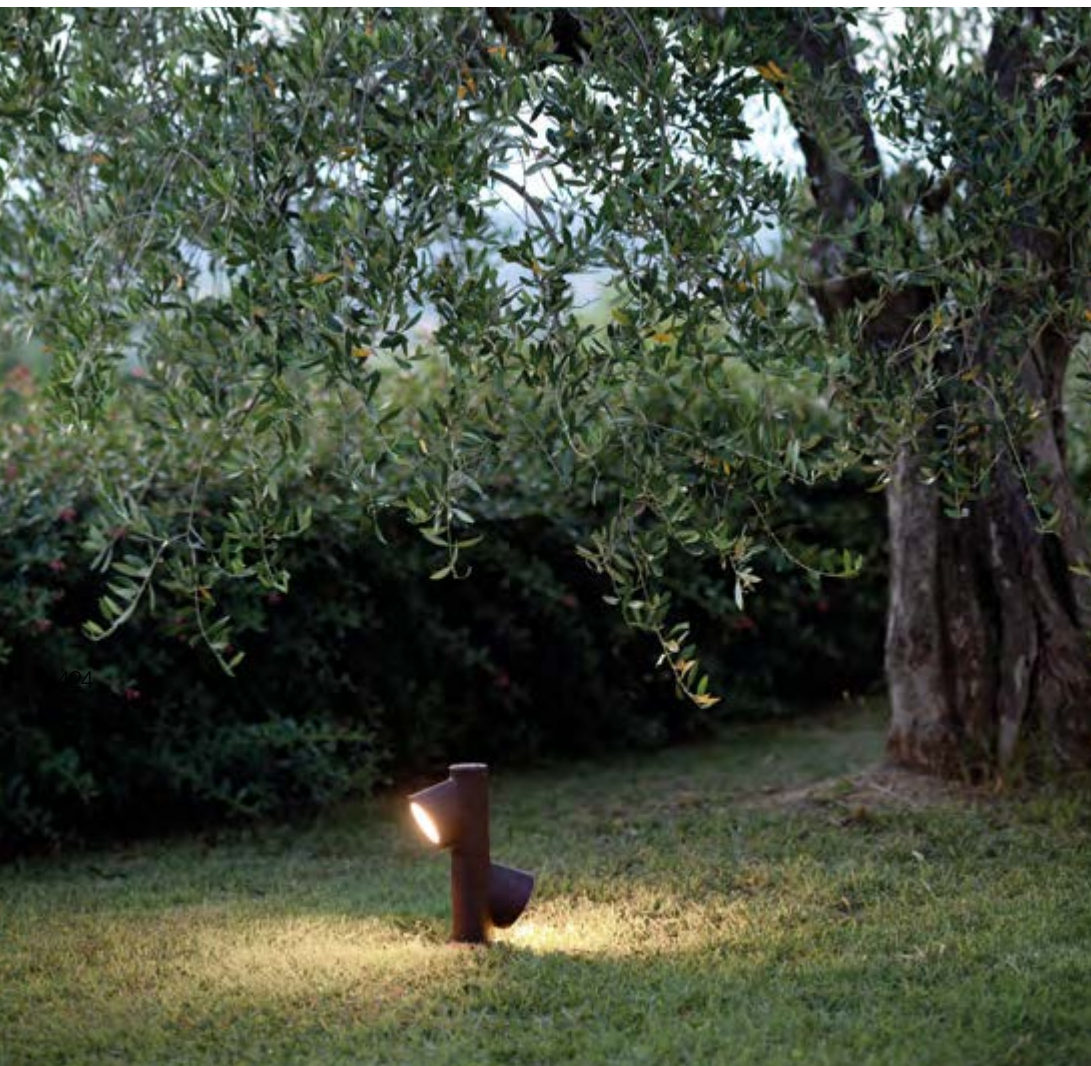







BRUCO

terra / ground

Lampada da esterno componibile a luce diretta. Struttura in pressofusione di alluminio verniciato nel colore antracite o corten, con base o con palo da fissare a terra. La lampada è componibile con gli elementi a lato (A,B,C,D,E), e da 1 a max 4 corpi lampada. Sorgente di luce LED integrata 230V. Ogni corpo lampada (A) può essere fissato al palo (E) con composizione unidirezionale o con 4 possibili posizioni a 90°.

Outdoor modular lamp, with direct light. Anthracite or corten die-cast painted aluminium structure, with base or with a pole to be fixed on the floor. The device can be composed with the elements on the side (A,B,C,D,E), up to 4 lamp bodies. Integrated 230V LED light source. Each element (A) can be fixed to the pole (E) with unidirectional composition or with four possible 90° positions.



IP65

watt	flusso/flux	CCT	dimensioni/size	Kg	colore/colour	codice/code
(A) corpo lampada / body lamp						
8W 230V	820lm	2700K	Ø 6,5 H 13,5 → 14	1	● antracite/anthracite ● corten/corten	40059/AN 40059/CO
(B) tappo / top						
			Ø 6,5 H 1	0,1	● antracite/anthracite ● corten/corten	40060/AN 40060/CO
(C) base / base						
			Ø 13 H 3	0,6	● antracite/anthracite ● corten/corten	40061/AN 40061/CO
(D) giunto / joint						
			Ø 6,5 H 0,5	0,2	● antracite/anthracite ● corten/corten	40062/AN 40062/CO
(E) palo / pole						
			Ø 6,5 H 33	1	● antracite/anthracite ● corten/corten	40063/AN 40063/CO
(E) palo / pole						
			Ø 6,5 H 47	1,3	● antracite/anthracite ● corten/corten	40064/AN 40064/CO
(E) palo / pole						
			Ø 6,5 H 138,5	1,3	● antracite/anthracite ● corten/corten	40181/AN 40181/CO

su richiesta disponibile con LED 12W / on request available with 12W LED

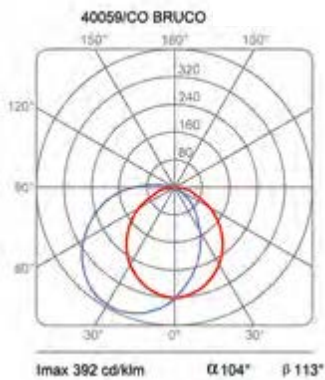
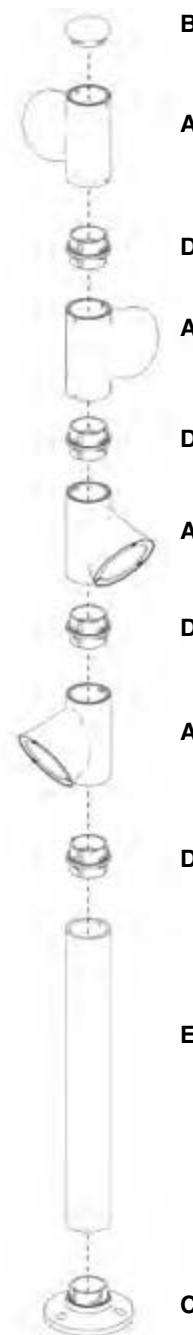



ESEMPI DI COMPOSIZIONE / EXAMPLES OF COMPOSITION

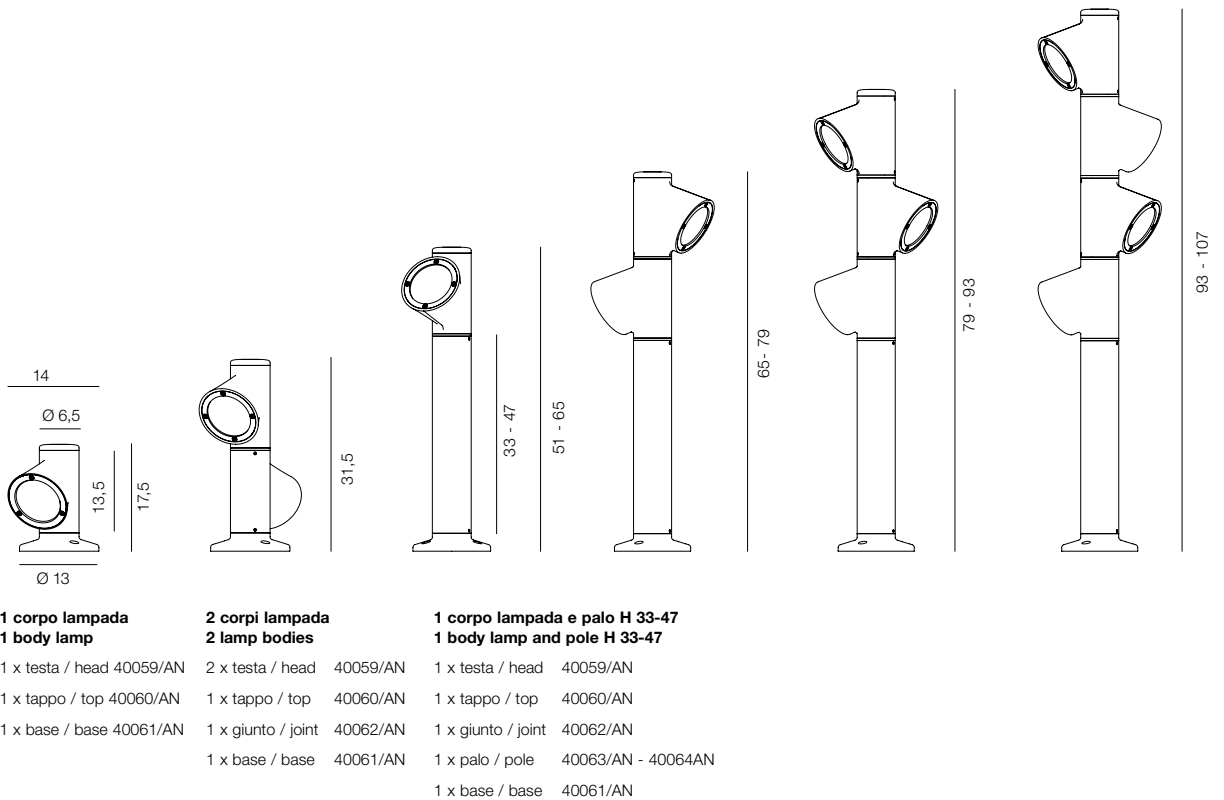

BRUCO

parete / wall

Lampada da parete della famiglia Bruco per esterno, a luce diretta/indiretta. Struttura in pressofusione di alluminio verniciata nei colori antracite o corten. Disponibile a uno o a due corpi lampada da assemblare con diverso orientamento a 90°. Sorgente di luce a LED integrata 230V.

Outdoor Bruco family wall lamp, direct/indirect light. Structure in aluminium die casting painted in anthracite or corten colours. Available with one or two lamp bodies to be assembled with different 90° orientation. Integrated LED light source 230V.



IP65

watt	flusso/flux	CCT	Kg	colore/colour	codice/code
------	-------------	-----	----	---------------	-------------

1 CORPO LAMPADA / BODY LAMP

8W 230V	820lm	2700K	1,5	● antracite/anthracite	1440/AN
				● corten/corten	1440/CO

2 CORPI LAMPADA / BODIES LAMP

2x8W 230V	2x820lm	2700K	2,5	● antracite/anthracite	1440/2/AN
				● corten/corten	1440/2/CO

su richiesta disponibile con LED 12W / on request available with 12W LED

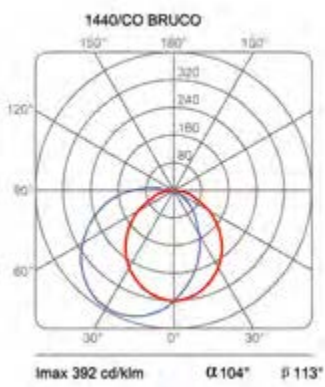
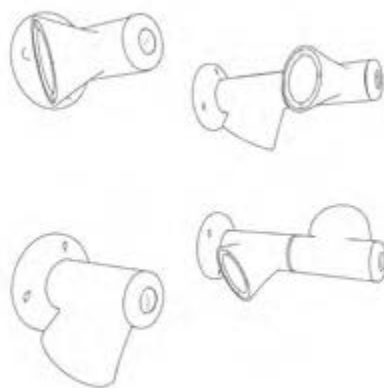
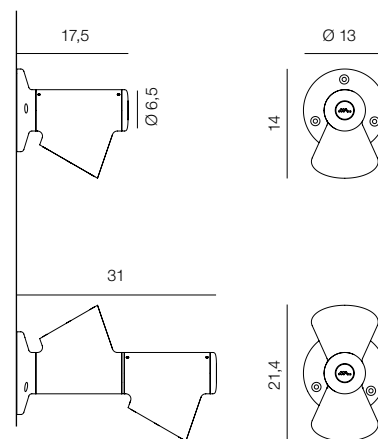



BOLETO

Esili strutture che spuntano dal prato.
Il colore corten come la cappella del
omonimo fungo.
La luce indiretta illumina
in modo non invadente un percorso, gli
angoli e i cespugli
nel giardino.

Slender structures springing up from
your garden. Corten in colour, like the
cap of the homonymous mushroom.
The light with indirect illuminates a
pathway, the corners and bushes of
your garden.

Emiliana Martinelli







BOLETO

terra / ground

Lampada da esterno a luce indiretta per sorgente di luce a LED. Struttura in alluminio verniciato nel colore corten. Stelo in tre altezze con base per il fissaggio a terra. Si consiglia l'installazione con fissaggio su un piccolo plinto di cemento o su una superficie piana. Disponibile anche un fissaggio con picchetto. Su richiesta a 24V con alimentatore remoto.

Outdoor lamp with indirect light for LED light source. Corten painted aluminium structure. Stem in three heights with base to be fixed on the ground.

We recommend to install the lamp fixing on a plint of concrete or on a flat surface. Also available in the version with peg. On request 24V with remote driver.

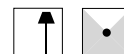

IP65

watt	flusso/flux	CCT	Kg	colore/colour	codice/code
BOLETO H35					
10W 230V	1000lm	2700K	3,4	● corten/corten	2308/230/J/CO
BOLETO H50					
10W 230V	1000lm	2700K	3,5	● corten/corten	2308/230/CO
BOLETO H70					
10W 230V	1000lm	2700K	3,6	● corten/corten	2308/230/70/CO

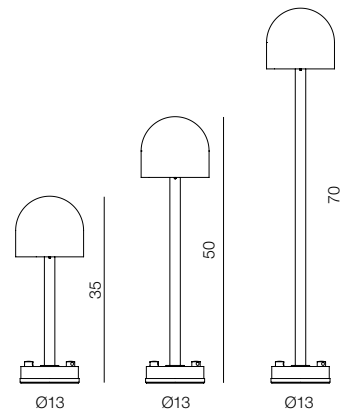

picchetto per fissaggio a terra / peg for ground fixing (optional)

40166

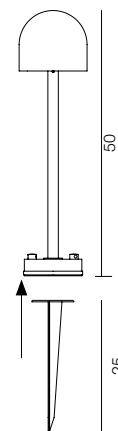

Su richiesta a 24V con alimentatore remoto / On request 24V with remote driver

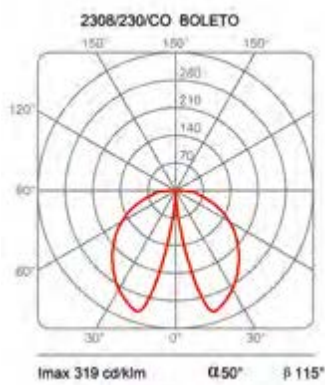



CYBORG outdoor

Una lampada da esterno a luce indiretta per sorgente di luce a LED. Una forma insolita con struttura stampata in cemento ad alta resistenza. Cyborg può essere appoggiato sul pavimento di casa o del terrazzo o fissato a terra con picchetti nel giardino.

An outdoor lamp with indirect light for LED light source.

An unusual shape with a high resistance moulded concrete structure. Cyborg can be placed on the floor of the house or terrace or fixed to the ground with pegs in the garden.

Karim Rashid







Il Diavolelto, S.Gennaro, Lucca - arch. Michel Boucquillon

CYBORG

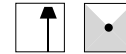

Lampada da esterno a luce indiretta con cavo elettrico e spina, da appoggiare o da fissare a terra con picchetti.
 Struttura stampata in cemento ad alta resistenza con idrorepellente, realizzato individualmente, con un processo artigianale.
 Disponibile nel colore grigio o giallo ocra.
 Per sorgente di luce a LED.

Outdoor lamp with indirect light to be placed on the ground with electric cable and plug or it can be fixed to the ground by using pegs.
 High resistance concrete structure, made waterproof with a handcrafted process.
 Available in grey or yellow-ochre colours.
 For LED light source.

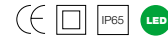

IP65

watt	flusso/flux	CCT	Kg	colore/colour	codice/code
10W 230V	1000lm	2700K	13	● grigio cemento/concrete grey	2306/GR
				● giallo ocra/yellow ochre	2306/GI

cavo di alimentazione nero e spina / black power cable and plug 5m

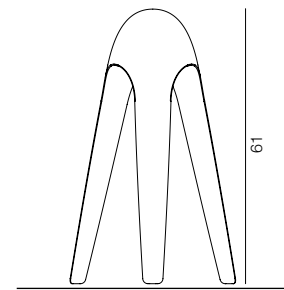

Ø40

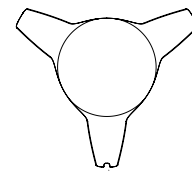

picchetti per il fissaggio a terra
 pegs for ground fixing

0,5

40111

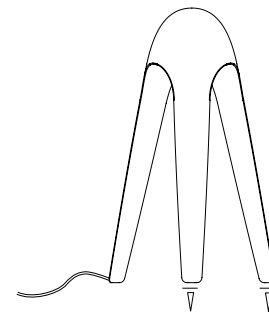

442

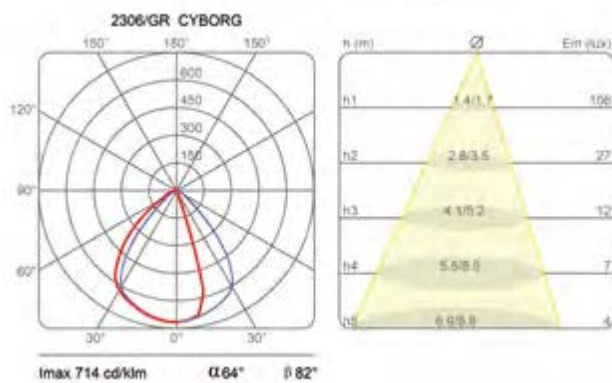



CYBORG big

Lampada da terra da esterno a luce diretta o diffusa.

Corpo lampada stampato con tecnologia rotazionale in polietilene nei colori verde, rosso o bianco.

La versione colorata di Cyborg Big è realizzata con materiale riciclato –Geco 30– la scelta migliore per le prestazioni meccaniche. Geco 30 contiene EcoAllene®, ricavato dal riciclo dei polilaccoppiati.

Sorgente di luce a lampadina LED, con cavo e spina.

Outdoor floor lamp providing direct or diffused light. Rotomoulded polyethylene lamp body in the colours green, red or white.

The coloured version of Cyborg Big is made with recycled material –Geco 30–, the best choice for mechanical performance. Geco 30 contains EcoAllene® that is derived from recycled polylaminate.

LED bulb light source, with cable and plug.

Karim Rashid

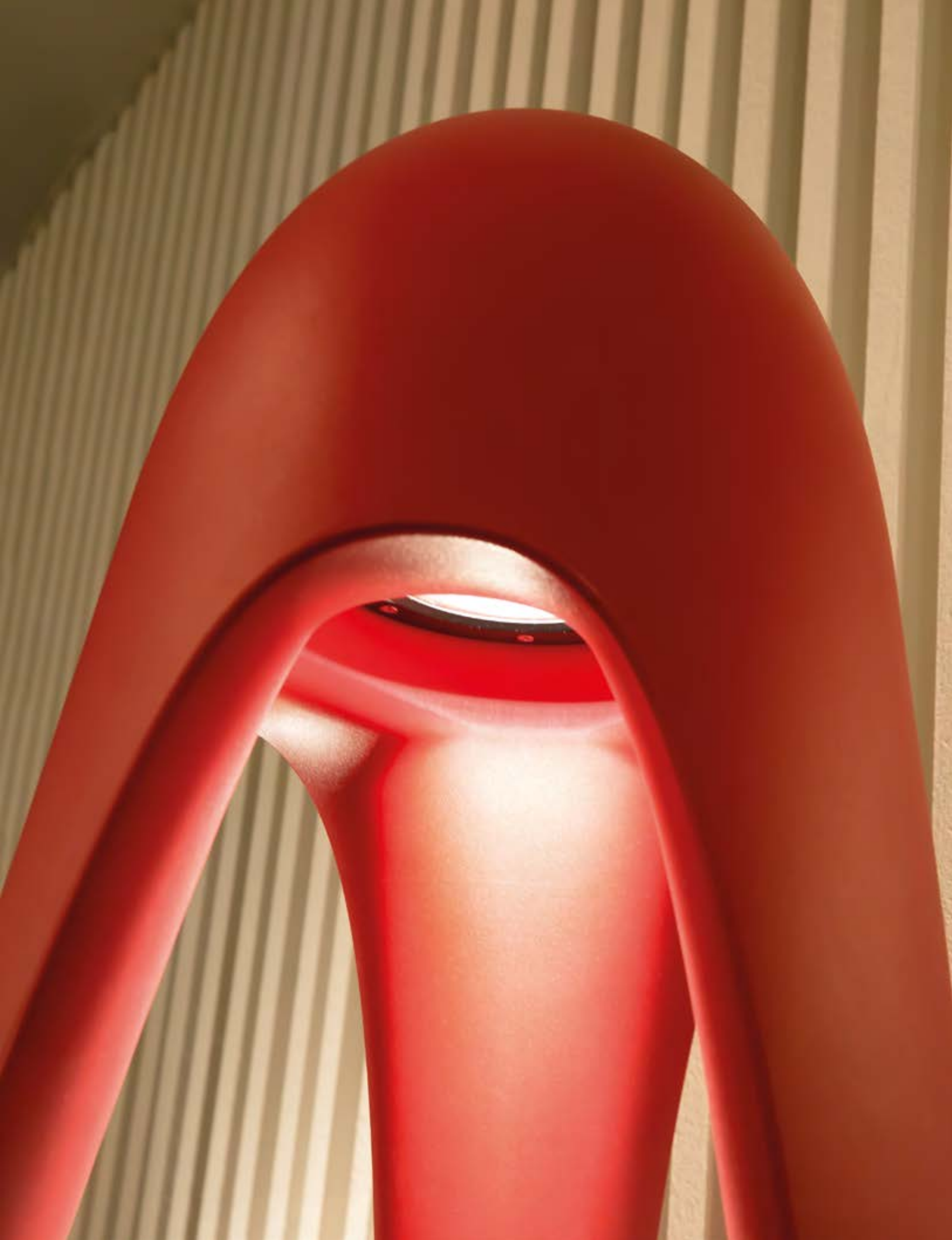





CYBORG BIG



Lampada da esterno da terra in due versioni: a luce diretta in polietilene colorato e a luce diffusa in polietilene opalino. Struttura stampata con tecnologia rotazionale. Disponibile nel colore verde militare o rosso in polietilene riciclato e nella versione opalina. Con cavo elettrico e spina, per lampadina LED.

Outdoor floor lamp in two versions: direct light in coloured polyethylene and diffused light in opaline polyethylene. Structure moulded using rotational technology. Available in military green or red colour in recycled polyethylene and in opal version. With electrical cable and plug, for LED bulb.



IP65

watt	flusso/flux	CCT	Kg	colore/colour	codice/code
------	-------------	-----	----	---------------	-------------

CYBORG BIG luce diffusa

12W E27 G95

○ bianco/white

2315/N/BI

cavo di alimentazione nero e spina / black power cable and plug 5m

LAMPADINE / BULBS

12W E27 G95

1100lm

3000K

540Y

kit picchetti per fissaggio a terra / kit pegs for ground fixing (optional)

40205

CYBORG BIG luce diretta

14W E27 PAR38

● verde militare/army green

2315/VE

● rosso oriente/oriental red

2315/RO

cavo di alimentazione nero e spina / black power cable and plug 5m

LAMPADINE / BULBS

20W E27 PAR38 45°

1910lm

3000K

510X

14W E27 PAR38 75°

1400lm

3000K

511X

kit picchetti per fissaggio a terra / kit pegs for ground fixing (optional)

40205

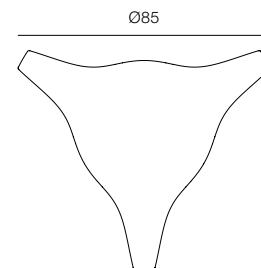
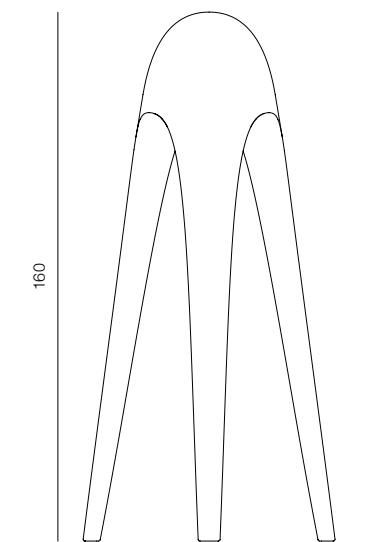

Cyborg Big è stampata con EcoAllene® certificato.

L'EcoAllene® è un nuovo materiale derivante dal riciclo dei polilaminati; per questo è definito eco-friendly. Con l'utilizzo di tecniche brevettate, ECOPLASTEAM ha sviluppato un sistema di produzione che permette di utilizzare gli scarti di polilaminati (PO-AL) per creare EcoAllene®. Questo si ottiene riciclando e riprocessando oggetti altrimenti destinati all'incenerimento o allo smaltimento: cartoni per bevande, imballaggi di prodotti oleosi, involucri di dolci, capsule per bevande calde, ecc.

Cyborg Big contains certified EcoAllene®. EcoAllene® is a new material resulting from the recycling of polyaminates; that's why it is defined eco-friendly. Using patented techniques, ECOPLASTEAM developed a production system that allows the use of poly laminate waste (PO-AL) to create EcoAllene® which is obtained by recycling and reprocessing objects otherwise dedicated to incineration or landfill: cartons for beverages, oily product packaging, confectionery wrappers, hot beverage capsules, ect.



PONT

Una lampada per esterno dalla struttura stampata in cemento per sorgente di luce a LED, da fissare a terra nel prato. Un ponte sottile come una lama, che illumina con luce indiretta il tuo giardino o delimita con la sua presenza un percorso.

An outdoor lamp with a concrete moulded structure for LED light source, to be fixed to the ground in the lawn. A bridge as thin as a blade, which illuminates your garden with indirect light or delimits a path with its presence.

Marc Sadler







PONT



Una lampada da esterno, a luce indiretta, per illuminare il tuo spazio verde.

Da fissare a terra con basette in acciaio inox in dotazione, o da fissare al terreno con picchetti (optional) da bloccare all'estremità della lampada. Struttura in cemento ad alta resistenza con idrorepellente con un processo artigianale, nel colore grigio cemento, altri colori su richiesta.

Per sorgente di luce a LED. Alimentatore remoto (escluso).

An indirect-light outdoor lamp to illuminate your green spaces.

To be fixed to the ground with stainless steel base elements (provided), or with pegs (optional) to be fixed at the extremity of the lamp.

Waterproof high-resistance concrete structure, in grey colour, other colours on request.

For LED light source.
Remote driver (escluded).



IP67

watt	flusso/flux	CCT	Kg	colore/colour	codice/code
24W 24V	1620lm	2700K	6,5	● grigio cemento concrete grey	40105/GR

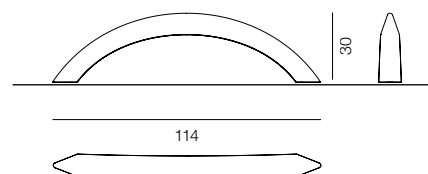

alimentatore remoto / remote driver IP67

30W 230/24V	1	40106
150W 230/24V	2	40107

scatola con alimentatore / box with driver IP67

30W 230/24V 20x20x20cm	2	40108
150W 230/24V 24x24x21cm	3	40109

kit 2 picchetti per il fissaggio a terra kit 2 pegs for ground fixing	0,6	40110
--	-----	-------



454

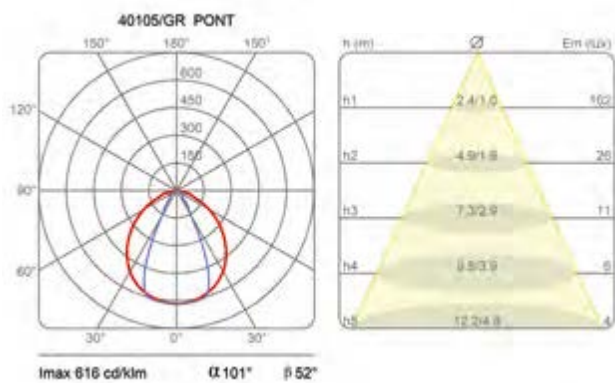



SISTEMA POLO

Una lampada da esterno a luce diffusa, a sospensione, con due diversi schermi, per illuminare il tuo spazio outdoor.

A diffused-light, pendant outdoor lamp with two different shades to enlighten your outdoor space.

Elio Martinelli e Emiliana Martinelli









KOALA

Una lampada da parete per esterno a luce diretta e indiretta. Una forma morbida realizzata in stampo in cemento ad alta resistenza. Per illuminare facciate di edifici pubblici e residenziali, e per segnare percorsi. Sorgente di luce a LED.

An outdoor wall lamp with direct and indirect light.
A soft shape molded in high resistance concrete.
To illuminate facades of public and residential buildings, and to mark paths.
LED light source.

Emiliana Martinelli



KOALA

Una lampada da parete per esterno a luce diretta/indiretta. Struttura stampata in cemento ad alta resistenza con idrorepellente con un processo artigianale, nel colore grigio cemento.
Diffusori in vetro satinato.
Per sorgente di luce a LED.

An outdoor wall lamp with direct/indirect light. Structure molded in high resistance concrete, made water-repellent with a hand-crafted process, in concrete grey colour.
Satin glass diffuser.
For LED light source.



IP65

watt	flusso/flux	CCT	Kg	colore/colour	codice/code
2x10W 230V	2x1000lm	2700K	4,7	● grigio cemento/concrete grey	1444/GR

alimentatore integrato / integrated driver

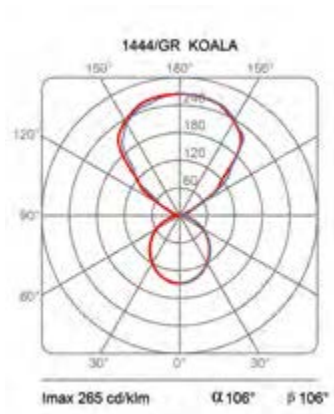
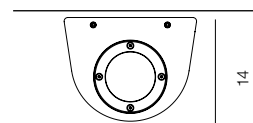
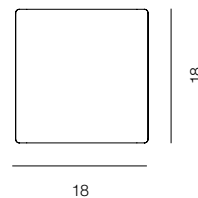



KIKI

Kiki si ispira all'oriente, ricordando con la sua forma morbida e leggera le lanterne di carta cinesi.

Nata nella versione a catenaria, oggi anche cordless per diventare la tua "compagna di luce" sia in casa tutti i giorni che in estate nel tuo giardino, per una festa, sul terrazzo, in barca e per una serata romantica.

Kiki può avere tante vite. Sempre diverse e fantasiose.

Kiki has the liveliness and lightweight beauty of Chinese paper lanterns. With a pinch of irony, traditions belonging to faraway worlds become contaminated and give life to a chain of lights to be used in a thousand different ways.

To decorate a terrace, a garden or an indoor space with lights.

To make a party special.

Kiki can have many lives.

Always different and creative.

Paola Navone







KIKI



Showroom Gervasoni, Milano



KIKI

catenaria / catenary

Una catenaria a luce diffusa per esterno. Lampada a sospensione composta da 3, 5 o 10 punti luce fissati sul cavo di alimentazione alla distanza di 1m uno dall'altro. Supporto stampato in resina e gomma, cablato per lampadina a Led, diffusore in polietilene stampato in rotazionale. Cavo di alimentazione con spina da esterno in tre lunghezze.

Outdoor suspension catenary lighting with diffused light, composed of 3, 5 or 10 light points mounted on the electrical cable at a distance of 1m from each other. Black resin and rubber molded support, wired up for LED bulbs. Polyethylene diffuser molded with rotational system. Power cable equipped with an outdoor plug, three lengths.

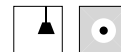

IP65

watt	Kg	colore/colour	codice/code
------	----	---------------	-------------

KIKI 8 m 3x5,3W E27 230V	2	○ bianco/white	21004/3/NE
-----------------------------	---	----------------	------------

cavo / cable 8 m - 3 lampade / lamps

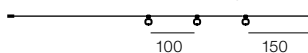

KIKI 10 m 5x5,3W E27 230V	3,2	○ bianco/white	21004/5/NE
------------------------------	-----	----------------	------------

cavo / cable 10 m - 5 lampade / lamps

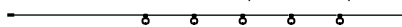

KIKI 15 m 10x5,3W E27 230V	6	○ bianco/white	21004/10/NE
-------------------------------	---	----------------	-------------

cavo / cable 15 m - 10 lampade / lamps

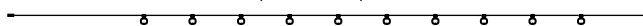

LAMPADINA / BULB

1x5,3W E27	max Ø45mm	5056
------------	-----------	------

GANCIO / HOOK	● nero/black	40054/NE
---------------	--------------	----------

gancio optional da avvitare al corpo lampada per fissare kiki ad un eventuale cavo teso di supporto.
optional hook to be screwed to the lamp body to fix kiki to a possible support cable.

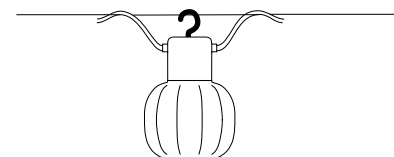
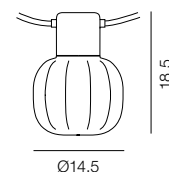

CAVO INOX / STAINLESS STEEL INOX CABLE

kit cavo inox 6m per 21004/3/NE	40169.2/NE
kit cavo inox 8m per 21004/5/NE	40169.1/NE
kit cavo inox 13m per 21004/10/NE	40169/NE



McDonald's, Parigi - arch. Paola Navone





KIKI

cordless

Lampada dimmerabile a luce diffusa per esterno.
Supporto stampato in resina e gomma per LED integrato.
Diffusore in polietilene stampato in rotazionale, maniglia intercambiabile in silicone nei colori: rosso, nero, grigio-verde.
Batteria ricaricabile, con cavo USB, durata batteria 7 ore.
Caricabatteria USB.

Diffused dimmable light lamp for outdoor.
Molded support in resin and rubber for integrated LED.
Diffuser in polyethylene, printed with rotational molding technology. Silicone interchangeable handle, provided in the following colours: red, black and grey-green.
Rechargeable battery, with USB cable, battery life 7 hours.
USB charger.



IP54

watt	flusso/flux	CCT	Kg	colore/colour	codice/code
1W 230V	110lm		0,5	○ bianco/white	21004/DIM/CL/NE
caricabatteria USB (opzionale) / USB charger (optional)					40065

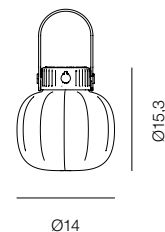

476



La lampada è completa di maniglia intercambiabile in silicone nei colori nero, rosso o grigio-verde (includere)

The lamp is provided with interchangeable silicone handle in black, red, grey-green colour (included)



La Ninfea - Coltivazione fiori di loto, Massarosa, Lucca

CIULIFRULI

Allegra, leggera e funzionale, Ciulifruli è progettata per essere appesa tra i rami degli alberi, a un gazebo o sospesa al soffitto, da sola o in gruppo, con una base da terra e, nella versione da interno, anche a grappolo e a ragno. Un gioco di forme e colori in grado di ravvivare e illuminare vari spazi.

Cheery, light and functional, Ciulifruli is designed to be hung amidst the branches of a tree, in a gazebo or from the ceiling, alone, with base, or in clusters and spider in the indoor version. A game of shapes and colours that enlivens and illuminates various spaces.

Atelier(s) Alfonso Femia
& Emiliana Martinelli











Ristorante Antico Oliveto, Seravezza, Lucca

CIULIFRULI

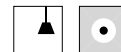

Una serie di lampade a sospensione per esterno a luce diffusa. In diverse forme e dimensioni stampate in rotazionale. Disponibili cinque diffusori nel colore bianco di diverse misure e cinque supporti in diversi colori: bianco, giallo, verde, azzurro e rosso per comporre la lampada. Supporti predisposti per lampadina a LED.

A series of suspension lamps for outdoor use with diffused light available in different shapes and sizes in rotational molding system. Available five white diffusers in different sizes and five supports in different colours: white, yellow, green, blue and red, to compose the lamp. Supports suitable for LED bulb.



IP65

watt	misure/size	Kg	colore/colour	codice/code
------	-------------	----	---------------	-------------

DIFFUSORI / DIFFUSERS

1) Ø16 H16	1,5	○ bianco/white	30859/BI
2) Ø23 H19	1,5	○ bianco/white	30860/BI
3) Ø15 H29	1,5	○ bianco/white	30861/BI
4) Ø29 H12,5	1,5	○ bianco/white	30862/BI
5) Ø50 H40	2,5	○ bianco/white	30903/BI

SUPPORTI / SUPPORTS

con cavo di alimentazione arancio e spina per lampadina E27 (5m)
with orange power cable and plug for E27 bulb

10W-14W-5,3W E27

1	○ bianco/white	30858/BI
1	● azzurro/light blue	30858/AZ
1	● giallo/yellow	30858/GI
1	● rosso/red	30858/RO
1	● verde/green	30858/VE

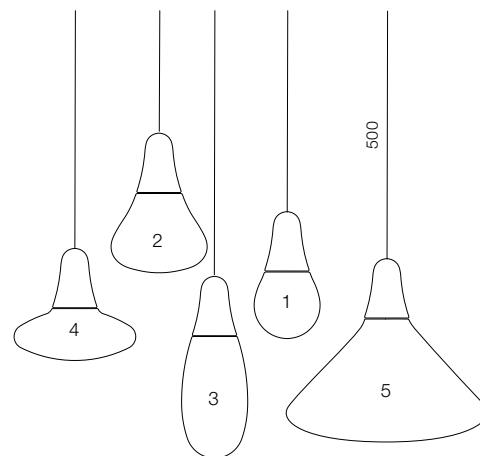

LAMPADINE / BULBS

1x10W E27	max Ø55mm (per diffusori/for diffusers 1-2-3)	5049
1x14W E27	max Ø55mm (per diffusori/for diffusers 5)	5278
1x5,3W E27	max Ø55mm (per diffusore/for diffuser 4)	5056



TRILLY

Una lampada versatile, un cono di luce che ti accompagna nei tuoi spazi outdoor. Puoi usarla in giardino appoggiata a terra nel prato, sul terrazzo, sospesa a un albero o a un gazebo, la puoi spostare da un posto a un altro e anche mettere a parete.

A versatile lamp, a cone of light that accompanies you in your outdoor spaces. You can use it in the garden resting on the lawn, on the terrace, suspended from a tree or a gazebo, you can move it from one place to another and even put it on the wall.

Emiliana Martinelli







TRILLY





TRILLY

Lampada per esterno a sospensione da appoggio e da parete, a luce diffusa.
 Struttura in polietilene stampata con la tecnologia rotazionale.
 Per lampadina LED.
 Disponibile in due dimensioni.
 Gancio per il fissaggio a parete (optional).

Outdoor suspension, floor or wall lamp, with diffused light.
 Rotational moulded technology in white polyethylene material.
 For LED bulb.
 Available in two sizes.
 Wall fixing hook (optional).

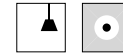

IP65

watt	Kg	colore/colour	codice/code
TRILLY Ø27 1x6W E27 230V	1,5	○ bianco/white	2073/J
TRILLY Ø45 1x15W E27 230V	3	○ bianco/white	2073
cavo di alimentazione arancio e spina / orange power cable and plug 5m			
gancio per il fissaggio a parete / wall fixing hook			30837

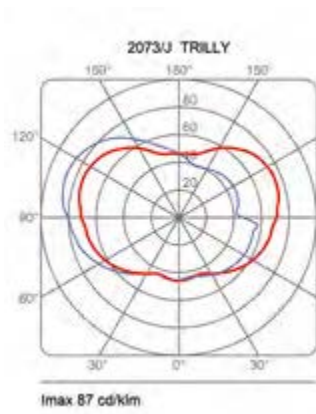
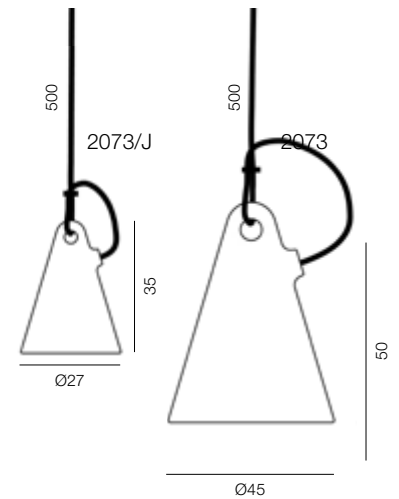



PISTILLO

Un segno di luce diffusa, solitario o in gruppo, disegna con una luce morbida la sua presenza in un percorso, tra gli alberi, in giardino e nello spazio esterno.

Sospeso in verticale con il suo gancio o fissato a terra con una base, crea dinamicità, movimento e colore all'ambiente outdoor.

A straight line, alone or in a group, essential and linear or equipped with an upper cone, it outlines its presence in the garden or in other outdoor environments with a soft light. If several elements are placed vertically, horizontally or slanting, they confer dynamism and motion like pistils gently swayed by the wind.

Emiliana Martinelli







PISTILLO

sospensione / suspension

Lampada a sospensione a luce diffusa per esterno. Struttura in metacrilato antiurto. Gancio stampato in resina nel colore nero che può essere fissato da entrambe le estremità per avere il cavo di alimentazione nella parte superiore o inferiore della lampada. Con cavo arancione da esterno di m 5 e spina. La versione Pistillo XS è disponibile con schermo in alluminio verniciato nel colore nero. Per sorgente di luce a LED con alimentatore elettronico integrato e per lampadina LED.

Suspension lamp with diffused light for outdoor use. Shockproof methacrylate structure. Hook molded in black resin which can be fixed from both ends to have the power cable at the top or bottom of the lamp. With 5 m orange outdoor cable and plug. The Pistillo XS version is available with black painted aluminium screen. For LED light source with electronic integrated driver and for LED bulb.

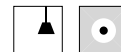

IP65

watt	flusso/flux	Kg	colore/colour	codice/code
------	-------------	----	---------------	-------------

PISTILLO				
25W 230V	1900lm	4,7	○ bianco/white	2064/P/L/1

alimentatore elettronico integrato / electronic integrated driver

PISTILLO XS				
1x12W E27 230V		2	○ bianco/white	2064/P/XS

schermo in alluminio verniciato per XS painted aluminium screen for XS			● nero/black	30812/NE
---	--	--	--------------	----------

cavo di alimentazione arancio e spina
orange power cable and plug 5m

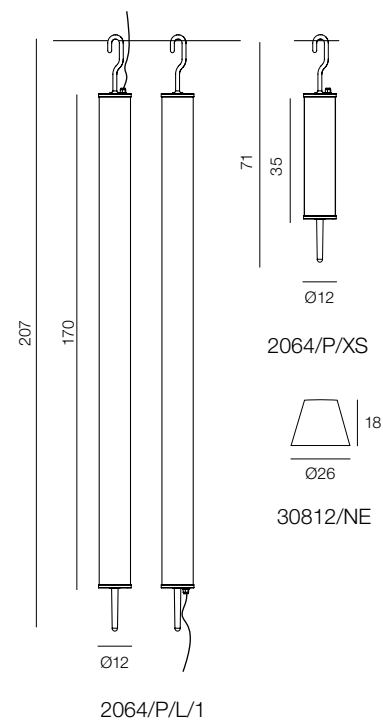







PISTILLO

terra / floor

Lampada per esterno a luce diffusa per esterno. Struttura cilindrica in metacrilato antiurto opal bianco. Da fissare a terra con base in acciaio satinato o spostabile con una base di appoggio di grande diametro (su richiesta). Cavo arancione da esterno di 5 m e spina. Per sorgente di luce a LED.

Outdoor floor lamp with diffused light. Cylindrical structure in white opal shockproof methacrylate. To be fixed to the ground with satin steel base or movable with a large diameter support base (on request). With 5 m orange outdoor cable and plug. For LED light source.

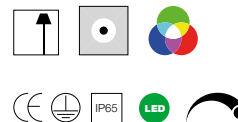

IP65

watt	flusso/flux	CCT	Kg	colore/colour	codice/code
PISTILLO					
54W 230V	4150lm	3000K	6	○ bianco/white	2294/L/1/DIM
PISTILLO RGBW					
54W RGBW 230V			6	○ bianco/white	2294/L/DIM

alimentatore elettronico dimmerabile integrato / dimmable electronic integrated driver

cavo di alimentazione arancio e spina / orange power cable and plug 3m

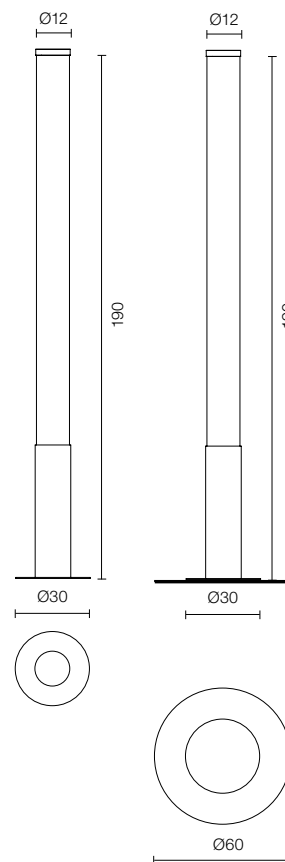

disponibile su richiesta una base di Ø60 per appoggiare la lampada a terra.

available on request a Ø60 base in order to place the lamp on the ground.



BICONICA POL

LIGHTYOU LIKE

Un segno semplice definisce un doppio volume, che sorprende per la sua forte identità.

Un unico elemento in polietilene stampato con la tecnologia rotazionale. Una fedele compagna per illuminare gli spazi esterni e interni con una luce diffusa, e grazie alla tecnologia Tunable White modulare la temperatura di colore dei LED.

A simple sign defines a double volume that surprises for its strong identity. A unique element printed with rotational molding technology. A faithful companion to illuminate outdoor and indoor spaces with a diffused light, thanks to the Tunable White LED technology the colour temperature can be modulated.

Emiliana Martinelli









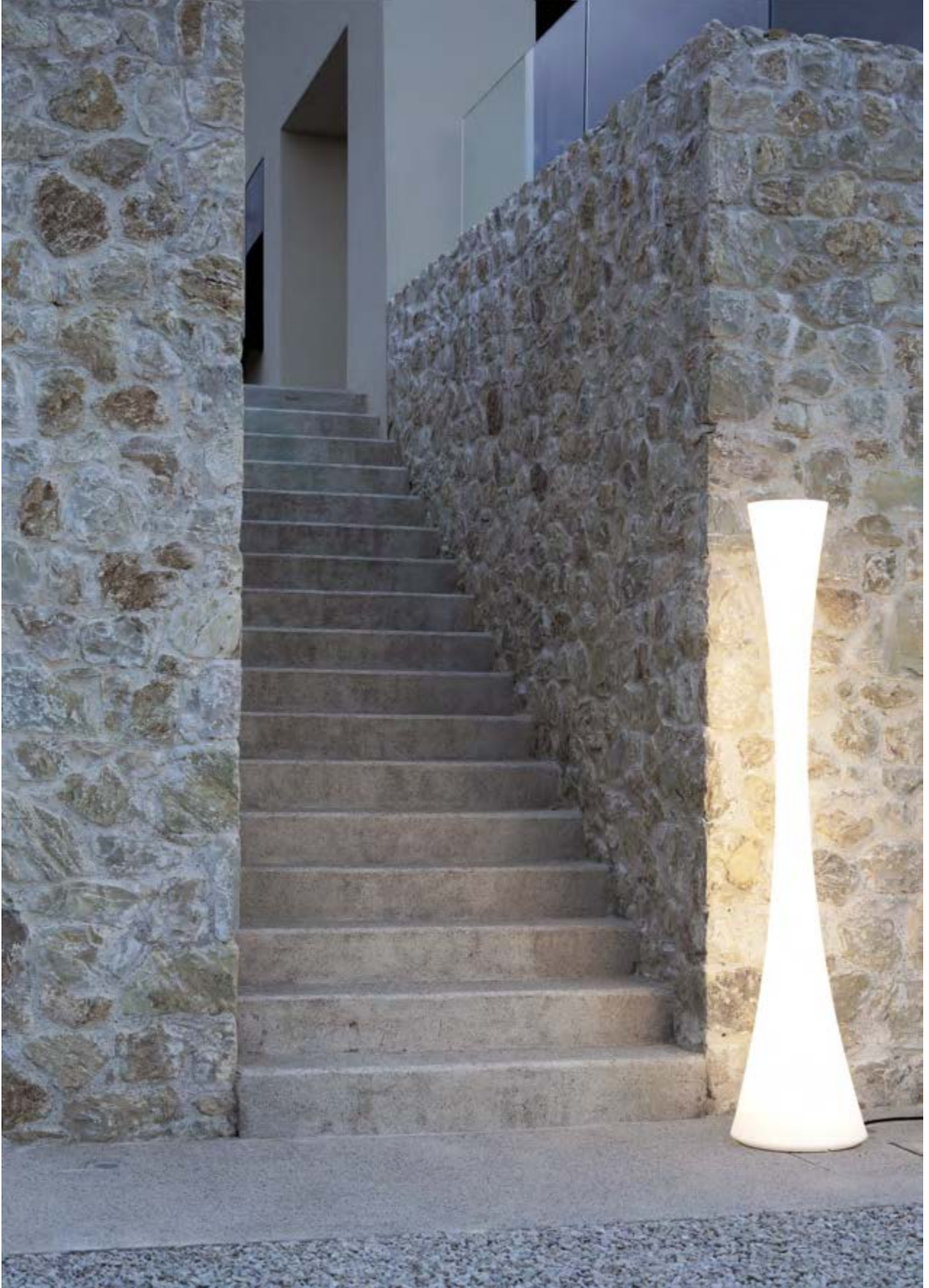

Il Diavoletto S.Gennaro Lucca - arch. Michel Boucquillon

BICONICA POL

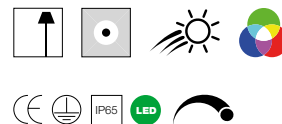

Lampada da terra per esterno a luce diffusa.
 In polietilene stampata in rotazionale.
 Sorgente di luce a LED integrata e alimentatore elettronico incluso.
 Disponibile nella versione Tunable White LED, bianco dinamico con tecnologia LYL (Light You Like), in grado di riprodurre l'andamento della luce naturale, modulando la temperatura di colore dei LED.
 E nella versione RGBW con tecnologia LYL.

Outdoor floor lamp, diffused light.
 Printed with rotational molding technology.
 Integrated LED light source and electronic driver.
 Available in the Tunable White LED version, dynamic white with LYL (Light You Like) technology it is able to reproduce the natural light pattern by modulating the colour temperature of the LED.
 With RGBW LYL technology also.

IP 65

watt	flusso/flux	CCT	Kg	colore/colour	codice/code
------	-------------	-----	----	---------------	-------------

BICONICA POL TUNABLE WHITE

144W	11980lm	2400/6700K	15	○ bianco/white	2217/POL/P/BD/L/1
------	---------	------------	----	----------------	-------------------

dimmerabile con telecomando / dimmable remote control

BICONICA POL TUNABLE WHITE LYL LIGHTYOU LIKE

144W	11980lm	2400/6700K	15	○ bianco/white	2217/POL/P/BD/BT/L/1
------	---------	------------	----	----------------	----------------------

dimmerabile con bluetooth / dimmable with bluetooth 

BICONICA POL RGBW LYL LIGHTYOU LIKE

180W RGBW	9.187lm		15	○ bianco/white	2217/POL/P/BT/L
-----------	---------	--	----	----------------	-----------------

dimmerabile con bluetooth / dimmable with bluetooth 

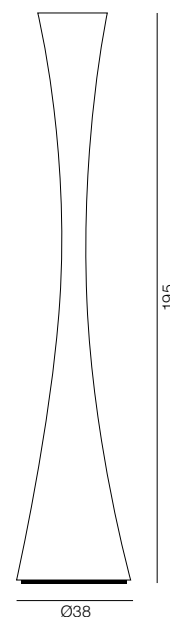

cavo di alimentazione arancio e spina / orange power cable and plug 3 m

le versioni con dispositivo bluetooth Casambi richiedono app iOS e Android (free)
 versions with Casambi bluetooth device require iOS and Android apps (free)

disponibile su richiesta nella versione per ancoraggio fisso a pavimento
 available on request in the version for fixed anchoring to the floor

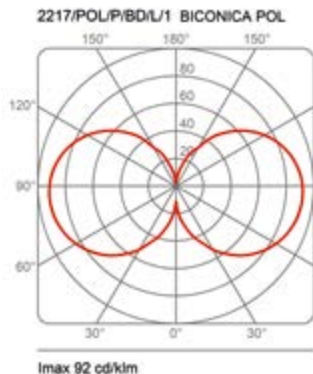



Ex Monastero S. Agostino, Vicopelago, Lucca

GLOUGLOU POL

Una bolla di luce che galleggia
sull'acqua della tua piscina e nel
laghetto.

Tanti colori per tanti effetti di luce che
si raddoppiano fluttuando sul pelo
dell'acqua.

A light bubble floating on the water of
your pool and pond.
Many colours for many light effects that
double as they float on the surface of
the water.

Emiliana Martinelli



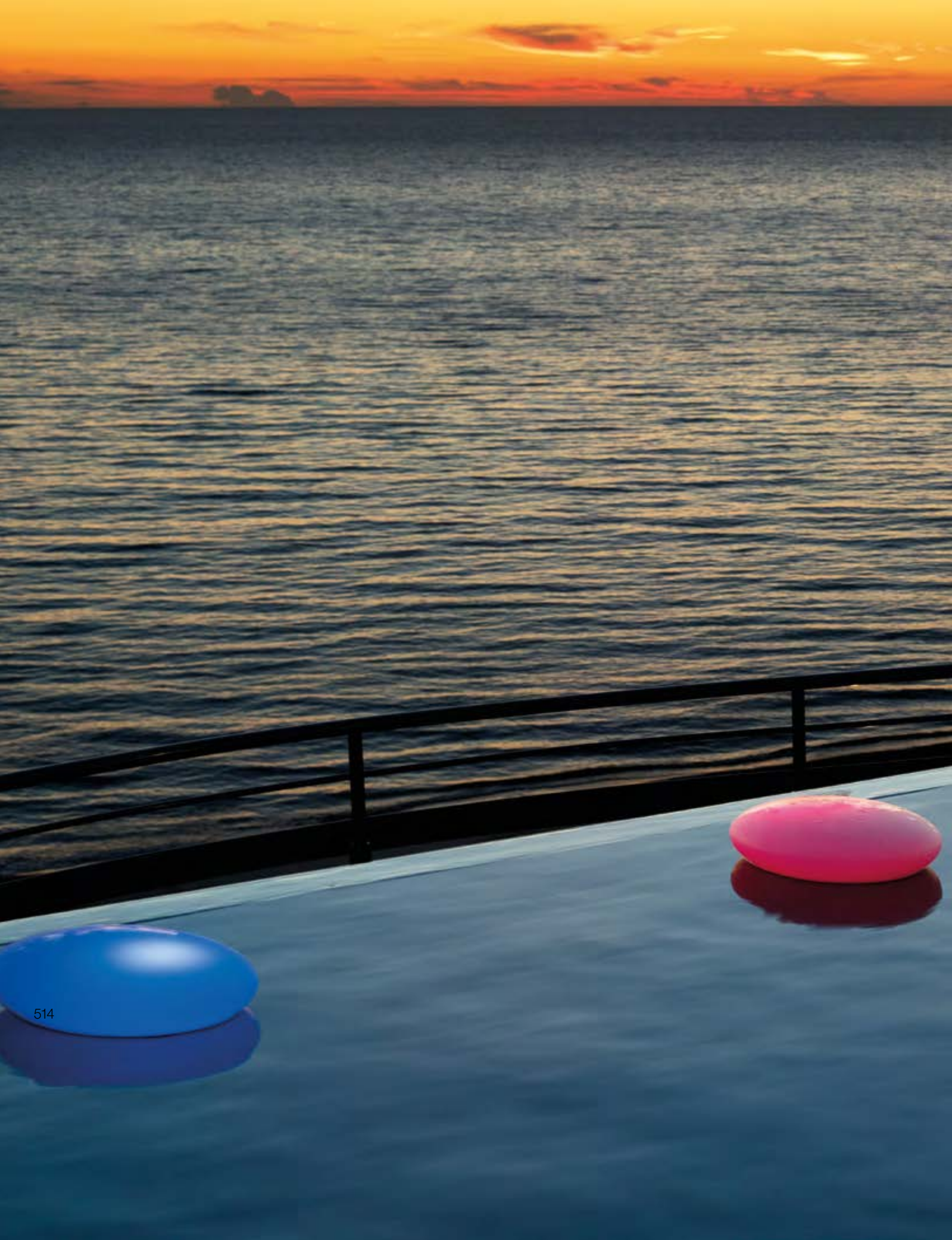

514



GLOUGLOU POL

cordless

Lampada galleggiante o da appoggio, per esterno a luce diffusa.
Stampata con la tecnologia rotazionale materiale polietilene bianco.
Sorgente di luce a LED RGBW, batteria inclusa ricaricabile, durata 6 ore.

Outdoor floating lamp or floor lamp, with diffused light, printed with rotational molding technology, white polyethylene material, RGBW LED light source, rechargeable battery included, life 6 hours.



IP67

watt	flusso/flux	CCT	Kg	colore/colour	codice/code
1x1,5W RGBW 230V con telecomando / remote control			1,5	○ bianco/white	822/BI

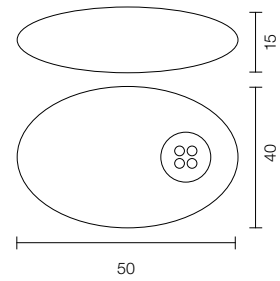

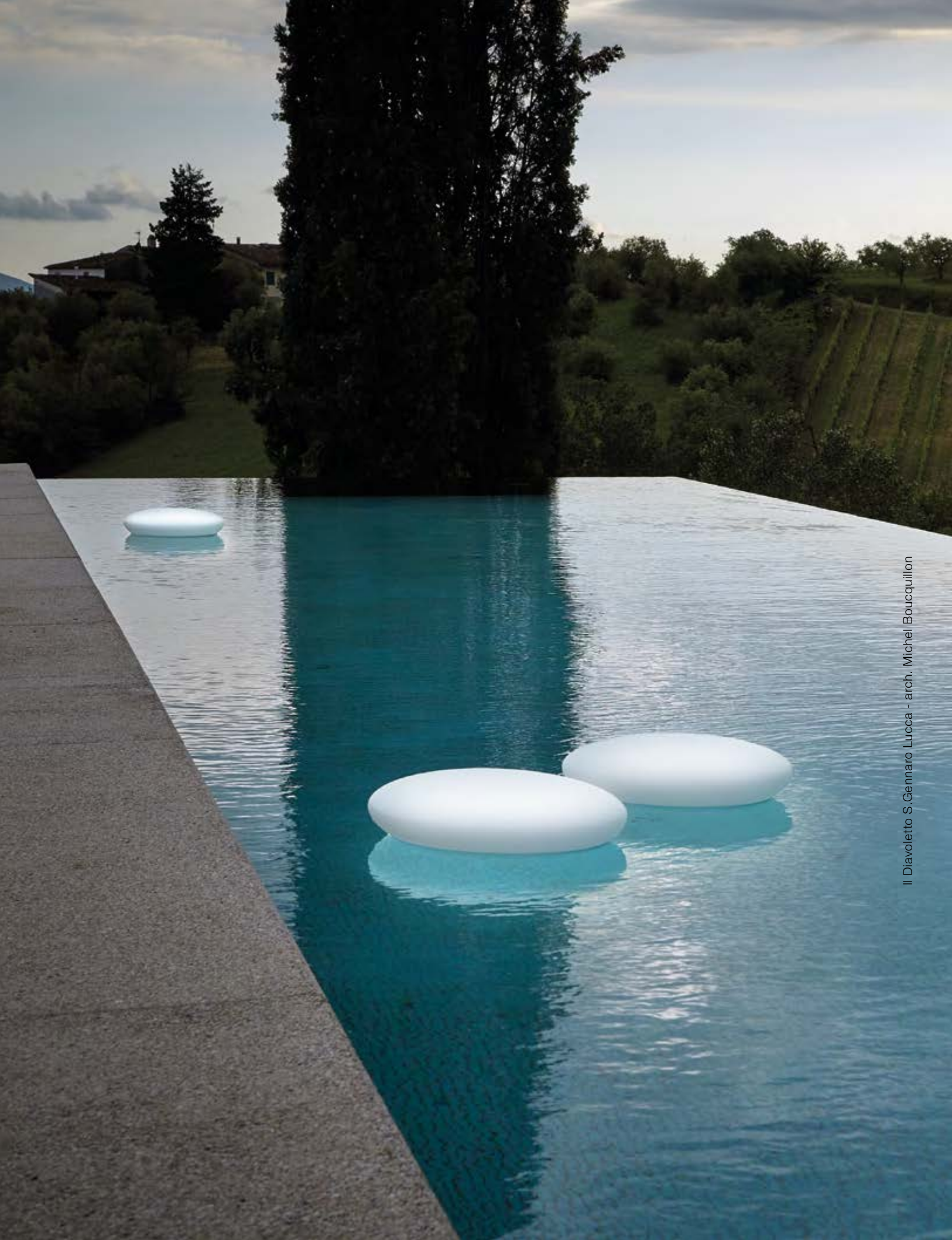

Il Diavolletto S. Gennaro Lucca - arch. Michel Boucquillon

BOWL

Una sfera a luce diffusa in polietilene,
da appoggiare nel prato, sul pavimento
del terrazzo o anche in casa.

La maniglia permette di prenderla
e spostarla facilmente nel punto da
illuminare.

A polyethylene diffused light sphere, to
be placed in the lawn, on the terrace
floor or even in the house.

The handle allows to easily lift it and
move it to the right place you want to
illuminate.

Serge & Robert Cornelissen



BOWL

Villa Bernardini, Vicopelago, Lucca

520





BOWL

Lampada da appoggio per esterno a luce diffusa. Stampata in rotazionale, materiale polietilene bianco, particolare maniglia di colore nero stampata in resina.
 Con cavo (3 m) e spina.
 Per lampadina a LED.

Outdoor floor lamp with diffused light.
 Printed with rotational molding technology, white polyethylene material, black handle in moulded resin.
 With cable (3 m) and plug.
 For LED bulb.

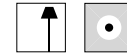

IP65

watt	Kg	colore/colour	codice/code
1x15W E27 230V	2	○ bianco/white	812
cavo di alimentazione e spina / power cable and plug 3m			
picchetto per fissaggio a terra / peg for ground fixing (optional)			40175

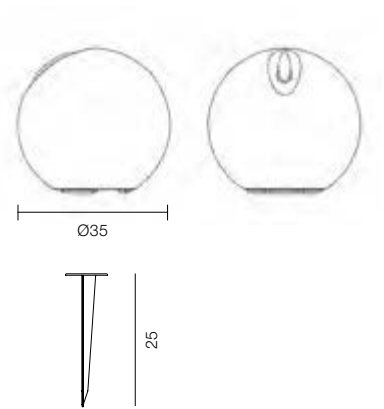



Per essere sempre informati sulle novità, oltre ai cataloghi è utile consultare le sezioni del nostro sito WEB ufficiale: www.martinelliluce.it, di facile consultazione e che viene aggiornato costantemente, per avere un riscontro veloce e approfondito alle vostre esigenze. È possibile effettuare direttamente dal sito il download dei nostri prodotti in 3D e le relative curve fotometriche da utilizzare per i vostri progetti. Martinelli Luce offre la massima collaborazione del proprio studio tecnico per proporre al cliente soluzioni illuminotecniche anche per singoli progetti o risolvere problematiche specifiche.

To keep abreast of all these novelties, in addition to our catalogs, you can browse the different sections of our official website: www.martinelliluce.it. User-friendly and constantly updated, it provides quick & in-depth answers to your needs. Also, you can download our products in 3D and the relative photometric curves that you can use for your projects, directly from the website. Martinelli Luce offers the full collaboration of its technical department to propose customers lighting solutions also for individual projects or to help find answers to specific issues.

informazioni generali
general informations



Alcune fotografie possono mostrare prodotti non standard in quanto realizzati per particolari progetti o installazioni.

Some pictures may show non-standard products as they are made for particular projects or installations.

Su richiesta le lampade possono essere verniciate in altri colori, da valutare al momento dell'ordine.

On request, the lamps can be painted in other colors, to be evaluated at the time of order.

Dove non diversamente specificato i nostri LED sono CRI>85

Unless otherwise specified, our LEDs are CRI> 85

I flussi luminosi (lumen) e la potenza indicata (Watt), evidenziati in ogni singolo apparecchio sono i valori nominali corrispondenti alla relativa sorgente di luce. I dati effettivi sono visibili all'interno delle nostre curve fotometriche in formato Eulumdat scaricabili dal nostro sito web nell'area download, oppure all'interno di ogni singola scheda prodotto.

The luminous fluxes (lumen) and the specified power (Watt), underlined in each device, are the nominal values corresponding to the relative source of light. The real data are visible in our photometric curves in a Eulumdat format, you can download from our web site in the download area, or in each product specifications.

Per le lampade da esterno in cemento, ti ricordiamo che la tecnologia di produzione utilizzata richiede cura artigianale e ogni pezzo è interamente realizzato a mano. Eventuali piccole imperfezioni devono essere considerate normali e non devono essere considerate come difetti, ma piuttosto caratteristiche del materiale utilizzato che rendono ogni pezzo unico e diverso, aumentandone la preziosità.

For outdoor lamps made of concrete, we remind you that the production technology used requires artisan care and each piece is entirely handmade. Any small imperfections are to be considered normal and should not be considered as faults, but rather characteristics of the material used that make each piece unique and different, increasing its preciousness.

Per lampade da esterno si consiglia di utilizzare uno scaricatore di sovratensione.

For outdoor lamps it is recommended to use a surge arrester.

	BI	bianco / white
	NE	nero / black
	AZ	azzurro / light blue
	VE	verde / green
	RO	rosso / red
	AR	arancio / orange
	GI	giallo / yellow
	GR	grigio / grey
	TR	trasparente / transparent
	AL	alluminio / aluminium
	CU	rame / copper
	CP	rame perlato / pearl copper
	AU	oro perlato / pearly gold
	BZ	bronzo / bronze
	AN	antracite / anthracite
	CO	corten / corten
	LU	lucido / polished
	BM	bronzo materico/ rough bronze
	OV	ottone vintage/vintage brass

SIMBOLI / SYMBOLS

TIPOLOGIA DI LAMPADA LAMPS TYPOLOGY

	cordless		lampade sospensione suspension lamps
	foro dell'incasso recessed hole		lampade da terra standing lamps
	easy replace technology		lampade da parete wall lamps
	bluetooth		lampade da soffitto ceiling lamps
	dimmerabile dimmable		lampade per binario elettrificato electrified track lamps
	bianco dinamico dynamic white		lampade da incasso recessed lamps
	comfort acustico acoustic comfort		lampade galleggianti floating lamps





 giunto magnetico
magnetic joint

 low UGR

 RGB

 RGBW

EMISSIONE DI LUCE / LIGHT EMISSION

	luce diretta direct light
	luce indiretta indirect light
	luce diretta indiretta direct indirect light
	luce diffusa diffused light
	luce orientabile swiveling light

FASCIO DI LUCE / LIGHT BEAM

molto stretto very narrow	<10°
stretto narrow	11°-20°
medio medium	21°-30°
largo wide	31°-40°
molto largo very wide	>40°

 Con sorgente di luce a LED nella descrizione di ogni singolo apparecchio, significa che il LED è integrato e non sostituibile dal cliente.

With a source of LED light in the description of each device means that LED is integrated and it is not possible to replace it by customer.

 Con lampadina LED nella descrizione di ogni singolo apparecchio significa che è predisposto per lampadina LED, che può essere sostituita ma non è inclusa.

With LED bulb in the description of each device it means that it is preset to a LED bulb and it is possible to replace it, but it is not included.

DIM Dimmerabile nel codice di ogni singolo apparecchio significa che è fornito di alimentatore con protocollo DALI, PUSH, 0-10V, 1-10V, TRIAC 3, TRIAC 5.

Dimmable in the code of each device means that it is equipped with a DALI, PUSH, 0-10V, 1-10V, TRIAC 3, TRIAC 5 driver protocol.

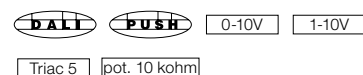

DISPOSITIVI PER LA DIMMERAZIONE
DIMMING DEVICES 

DISPOSITIVO WIFI / WIFI DEVICE cod. 40204.1

dispositivo Wi-Fi Tuya per la dimmerazione con app e pulsante (escluso)

Tuya Wi-Fi device for dimming with app and button (not included)

DISPOSITIVO RF / RF DEVICE cod. 40204.2

Dispositivo dimmerabile in radio frequenza Tuya per pulsante (necessario)

Tuya radio frequency dimming device for push button (required)

PULSANTE / BUTTON cod. 40209

CLASSI DI ISOLAMENTO
INSULATION CLASSES

GRADO DI PROTEZIONE IP
IP PROTECTION DEGREE

MARCHI DI CERTIFICAZIONE
MARKS OF APPROVAL



Classe prima, ovvero apparecchio provvisto di isolamento fondamentale in ogni parte e con parti conduttrici accessibili collegate ad un conduttore supplementare di protezione (messa a terra).

Class 1: appliance fitted with basic insulation throughout and with accessible live parts connected to a supplementary safety circuit (ground).



Classe seconda, ovvero apparecchio provvisto di doppio isolamento o isolamento rinforzato senza dispositivi per la messa a terra.

Class 2: appliance fitted with double insulation or reinforced insulation without ground connection.



Classe terza, ovvero apparecchio previsto per il funzionamento a bassissima tensione di sicurezza in cui non si producono tensioni superiori alla stessa.

Class 3: appliance designed for safety extra low voltage (S.E.L.V.) operation in which not higher voltages are produced.



Apparecchio protetto contro la penetrazione di corpi solidi di dimensioni maggiori a 12 mm e non protetto nei confronti dei liquidi.

Protected against the penetration of solid objects greater than 12 mm and non protected against liquids.



Apparecchio protetto contro la penetrazione di corpi solidi di dimensioni maggiori a 1 mm.

Protected against the penetration of solid objects greater than 1 mm.



Apparecchio protetto contro gli spruzzi d'acqua.

Splashwater-proof device.



Apparecchio protetto contro i getti d'acqua.

Device protected against water jets.



Apparecchio protetto per immersione temporanea.

Device protected by temporary immersion.



IMQ-IQNET - Qualità, ambiente e sicurezza sul lavoro. Queste sono le aree su cui verte il Sistema di Gestione Integrato (SGI) che abbiamo adottato, una combinazione di certificazioni ISO per migliorare le performance aziendali in questi campi di applicazione. Dal 2008 siamo certificati UNI EN ISO 9001:2015 (Gestione del Sistema Qualità) per il Design e la Produzione di apparecchiature in ambito lighting. Dal 2022 siamo certificati UNI EN ISO 14001:2015 (Sistema di Gestione Ambientale) per contenere l'impatto ambientale relativo alla progettazione e produzione di apparecchi illuminanti.

IMQ-IQNET Quality, environment and work safety. These are the areas covered by the Integrated Management System (IMS) we have adopted, a combination of ISO certifications to improve company performance in these areas.

Since 2008 we are certified UNI EN ISO 9001:2015 (Quality System Management) for the Design and Production of lighting equipment.

Since 2022 we are certified UNI EN ISO 14001:2004 (Environmental Management System) to limit the environmental impact related to the design and production of lighting equipment.



ENEC 03 - il marchio ENEC (Certificazione Elettrica relativa alle Norme Europee) è un marchio volontario rilasciato da enti terzi. Certifica che il prodotto è conforme e rispetta i requisiti proposti dalla norma EN 60598 ed è progettato e realizzato in aziende il cui sistema di gestione della qualità soddisfa i requisiti della norma UNI EN ISO 9001:2015.

ENEC 03 - The label ENEC (Electrical Certification concerning European Standard) is a voluntary label granted by third organizations. It certifies that a product complies to the EN 60598 standards and has been designed and manufactured by companies with an approved UNI EN ISO 9001:2015 quality control system.



CE - Dichiaro che il produttore produce apparecchi conformi e rispondenti ai requisiti proposti dalla norma EN 60598/1.

CE - Declares that the manufacturer produces light fittings which comply with the requirements of the EN 60598.

Tutti gli apparecchi con sorgente LED sono stati testati secondo la norma IEC62471 o IEC/TR62778 vigenti (sicurezza fotobiologica delle lampade).

All the appliances with LED sources have been tested according to the current IEC62471 or IEC/TR62778 standards (photobiological safety of lamps).

GARANZIA WARRANTY

Martinelli Luce S.p.A garantisce i Prodotti da vizi e/o difetti nella lavorazione o nei materiali per un periodo di 24 mesi dalla data di acquisto dei prodotti (fa fede la fattura di vendita). Per garanzia si intende, ad insindacabile discrezione di Martinelli Luce S.p.A, la sostituzione parziale o totale di parti componenti volte al ripristino delle funzionalità, limitatamente ai vizi di costruzione. La garanzia non copre eventuali difetti o danni per utilizzo non conforme alle istruzioni di installazione e danni derivati dall'utilizzo di prodotti con un grado di protezione non adeguato ad ambienti dove possono essere presenti agenti contaminanti. Essa decade se i prodotti sono stati manomessi o riparati, da personale non appartenente a Martinelli Luce S.p.A. o da personale non espressamente da noi autorizzato per scritto. La garanzia decade altresì in tutte le altre cause quali, in via non limitativa, sono presenti controversie relative ai pagamenti, o non vengono fornite le necessarie informazioni atte a determinare la causa dei guasti, la mancata periodica manutenzione e l'installazione di ricambi su prodotti che non siano ricambi acquistati presso la Martinelli Luce S.p.A.

Sono esclusi dalla garanzia danni causati da eventi atmosferici, o da scariche elettriche o sovratensioni, e comunque se il prodotto è posizionato in ambienti non a norma con le leggi vigenti. La garanzia riguarda solo il valore del prodotto e non i costi di trasporto, smontaggio, rimontaggio e perizia. In caso di vizi accertati e tempestivamente denunciati (entro 8 giorni) la Martinelli Luce S.p.A. sarà tenuta alla sola sostituzione, riparazione o riaccredito a propria discrezione dei prodotti difettosi che dovranno essere rispediti nell'imballo originale, con esclusione di qualsiasi diversa ed ulteriore responsabilità per danni che possono verificarsi al cliente o a terzi a seguito ed in conseguenza dell'utilizzo dei prodotti da essa realizzati. Sono esclusi dalla garanzia le lampadine, i materiali sostituibili e soggetti a normale usura (batterie, accumulatori ecc.).

GARANZIA (estensione a 5 anni)

Martinelli Luce mette a disposizione, solo su richiesta, per i propri clienti professionali una garanzia di 5 anni riservata solo ai prodotti Architectural. Si prega di contattare il consulente commerciale della propria zona o direttamente l'azienda per maggiori dettagli in proposito.

Martinelli Luce S.p.A warrants its products to be free from faults and defects in material and workmanship for a period of 24 months from the date of purchase of the products (as certified by the sales invoice). By warranty we mean – following the irrevocable discretion of Martinelli Luce S.p.A – the total or partial replacement of component parts aimed at restoring functionality, limited to structural faults. The warranty does not cover any defects or damages due to use that does not comply with installation instructions and damages arising from the use of products with a level of protection not suitable for environments where contaminating agents may be present. The warranty is void if the products have been tampered with or repaired by people not from Martinelli Luce S.p.A. or by personnel not expressly authorized by us in writing. The warranty is void also in all other cases where, by way of example but not limited to, disputes regarding payments exist, or the information necessary to determine the cause of the failures is not provided, where there is a lack of periodical maintenance and in the event of installation of spare parts on products that are not spare parts purchased at Martinelli Luce S.p.A. Excluded from the warranty are damages caused by atmospheric events or by electrical charges and surges, and in any case if the product is placed in environments that do not comply with current laws in force. The warranty concerns only the value of the product and not transport costs, costs for dismantling, re-assembly and appraisal. In the event of defects ascertained and promptly reported (within 8 days), Martinelli Luce S.p.A. is to be held responsible for replacing, repairing or refunding – at its discretion – the defective products that must be re-shipped in their original packaging, with the exclusion of any different and further responsibility for damages that may arise with the customer or with third parties following the use of the products manufactured by the company. Excluded from the warranty are lightbulbs, replaceable materials and materials subject to normal wear (batteries, accumulators etc.).

WARRANTY (5-year extension)

Martinelli Luce provides a 5-year guarantee for its professional customers, only on request, reserved only for Architectural products. Please contact the sales consultant in your area or the company directly for more details.

INDICE PER CODICE / CODE INDEX

500X	272 289	1290/DIM/L/1/AN	368	1452/J/20/BI	276	2080/2/BZ	180
	296 329	1290/DIM/L/1/BI	368	1452/J/20/NE	276	2080/2/NE	180
5049	484	1396/S/L/1/Q1/BI	374	1452/J/38/BI	276	2080/3/BZ	180
5056	472 484	1396/S/L/1/R/BI	374	1452/J/38/NE	276	2080/3/NE	180
505X	304	1406/NE	192	1453/AN	412	2085/DIM/L/1/AN	346
510X	410 412 448	1407/C/XL/26D/BI	314	1453/AR	412	2085/J/DIM/L/1/AN	346
511X	410 412 448	1407/C/XL/26D/NE	314	1453/BL	412	2087/NE	184
513Y	410 412	1407/C/XL/36D/BI	314	1453/GI	412	2090/DIM/NE	214
519.1J	328	1407/C/XL/36D/NE	314	1454/AU	266	2090/G/DIM/NE	214
519J	328	1407/P/XL/26D/BI	312	1454/BI	266	2093/50/AU	262
520.1J	328	1407/P/XL/26D/NE	312	1454/CO	266	2093/50/BI	262
520J	328	1407/P/XL/36D/BI	312	1454/J/AU	266	2093/50/CO	262
521.1J	328	1407/P/XL/36D/NE	312	1454/J/BI	266	2093/50/NE	262
521J	328	1410/B/AU	196	1454/J/CO	266	2093/AU	262
522J	328	1410/B/NE	196	1454/J/NE	266	2093/BI	262
523.1J	328	1421/NE	186	1454/NE	266	2093/CO	262
523J	328	1433/J/NE	226	1884/AN	460	2093/J/50/AU	262
524.1J	328	1433/NE	226	1884/BI	460	2093/J/50/BI	262
524J	328	1438/NE	304	1884/CO	460	2093/J/50/CO	262
525.1J	328	1440/2/AN	430	1884/S/AN	460	2093/J/50/NE	262
525J	328	1440/2/CO	430	1884/S/BI	460	2093/J/AU	262
526J	328	1440/AN	430	1884/S/CO	460	2093/J/BI	262
540Y	448	1440/CO	430	2003/50/DIM/L/1/AN	340	2093/J/CO	262
541Y	418	1441/20/BI	272	2004/SL/125/DIM/L/1/AU	086	2093/J/NE	262
542Y	418	1441/20/DIM/BI	272	2004/SL/125/DIM/L/1/BI	086	2093/NE	262
544.1J	328	1441/20/DIM/NE	272	2004/SL/65/DIM/L/1/AU	086	2097/NE	218
544J	328	1441/20/NE	272	2004/SL/65/DIM/L/1/BI	086	2098/DIM/L/1/GR	358
545J	272-289	1441/38/BI	272	2004/SL/95/DIM/L/1/AU	086	2217/POL/P/BD/BT/L/1	510
	296-329	1441/38/DIM/BI	272	2004/SL/95/DIM/L/1/BI	086	2217/POL/P/BD/L/1	510
547X	328	1441/38/DIM/NE	272	2011/80/L/1/BI	352	2217/POL/P/BT/L	510
548X	328	1441/38/NE	272	2011J	352	2275/2/L/1/Q1/BI	376
565.1J	330	1444/GR	464	2057/DIM/L/1/BI	114	2275/2/L/1/R/BI	376
565J	330	1449/14/BI	288	2057/J/DIM/L/1/BI	114	2277/L/1/NE	334
566.1J	330	1449/14/DIM/BI	288	2057/XS/DIM/L/1/BI	114	2277/L/NE	334
566J	330	1449/14/DIM/NE	288	2057/XXL/DIM/L/1/BI	130	2278/NE	202
567.1J	330	1449/14/NE	288	2057/XXL/Q/DIM/L/1/BI	130	2290/AU	204
567J	330	1449/32/BI	288	2063/DIM/L/1	136	2290/NE	204
591J/NE	328	1449/32/DIM/BI	288	2063/L	136	2293/3/NE	222
592J/NE	328	1449/32/DIM/NE	288	2063/L/1	136	2294/L/1/DIM	502
593J/NE	328	1449/32/NE	288	2064/P/L/1	498	2294/L/DIM	502
597.1J	330	1450/2/24/NE	304	2064/P/XS	498	2306/GI	442
597J	330	1450/24/NE	304	2070/NE	190	2306/GR	442
811/T/H/NE	208	1452/20/BI	276	2073	492	2308/230/70/CO	436
812	522	1452/20/NE	276	2073/J	492	2308/230/CO	436
822/BI	516	1452/38/BI	276	2080/1/BZ	180	2308/230/J/CO	436
		1452/38/NE	276	2080/1/NE	180	2309/AN	410

2309/AR	410	5142.2	329	21003/400/DIM/AU	042	30640/T	252
2309/BL	410	5142.3	329	21003/400/DIM/BI	042	30642	252
2309/GI	410	5278	484	21003/400/DIM/CU	042	30642	258
2309/J/AR	418	5289.2	252-254	21003/400/DIM/NE	042	30642.1	252
2309/J/BL	418		256-258	21003/500/DIM/AU	042	30642.1	258
2309/J/GI	418	5955/BI	326	21003/500/DIM/BI	042	30642.1/T	252
2311/GR	402	5955/NE	326	21003/500/DIM/CU	042	30642.1/T	258
2312/BI	200	5956/BI	326	21003/500/DIM/NE	042	30642/T	252
2312/GI	200	5956/NE	326	21004/10/NE	472	30642/T	258
2312/NE	200	5957/BI	326	21004/3/NE	472	30647	252
2315/N/BI	448	5957/NE	326	21004/5/NE	472	30647	254
2315/RO	448	5958/BI	327	21004/DIM/CL/NE	476	30647	258
2315/VE	448	5958/NE	327	21006/170/DIM/AU	044	30650	256
2320/GI	206	5959/BI	327	21006/170/DIM/BI	044	30650	258
2320/NE	206	5959/NE	327	21006/170/DIM/CU	044	30721/BI	256
2834/M/J/L/1	362	5960/BI	327	21006/170/DIM/NE	044	30728	254
2834/M/L/1	362	5960/NE	327	21006/250/DIM/AU	044	30728.1	254
2862/J/DIM/L/1/BI/AR	090	5961/BI	327	21006/250/DIM/BI	044	30728.1/T	254
2862/J/DIM/L/1/BI/BI	090	5961/NE	327	21006/250/DIM/CU	044	30728/T	254
2862/M/DIM/L/1/BI/AR	090	5962/BI	327	21006/250/DIM/NE	044	30729	254
2862/M/DIM/L/1/BI/BI	090	5962/NE	327	21010/DIM/AU	044	30729.1	254
2876/1/L/1/14/BI	384	5963/BI	327	21010/DIM/BI	044	30729.1/T	254
2876/1/L/1/14/NE	384	5963/NE	327	21010/DIM/CU	044	30729/T	254
2876/1/L/1/35/BI	384	5964/BI	327	21010/DIM/NE	044	30775	256
2876/1/L/1/35/NE	384	5964/NE	327	21012/20/BI	280	30775	258
2878/DIM/L/1/BI	116	5965/BI	327	21012/20/DIM/BI	280	30811.1	192
2882/L/1/O2/BI	386	5965/NE	327	21012/20/DIM/NE	280	30811.1	304
2882/L/1/R/BI	386	5967	327	21012/20/NE	280	30812/NE	498
2886/DIM/BI	066	21001/DIM/DK/GI	144	21012/38/BI	280	30836	180
2886/G/DIM/BI	066	21001/DIM/DK/GR	144	21012/38/DIM/BI	280	30837	492
2886/J/DIM/BI	066	21001/DIM/DK/VE	144	21012/38/DIM/NE	280	30858/AZ	484
2887/BI	320	21001/DIM/GI	144	21012/38/NE	280	30858/BI	484
2887/NE	320	21001/DIM/GR	144	21013/20/BI	282	30858/GI	484
2899/AU	264	21001/DIM/VE	144	21013/20/NE	282	30858/RO	484
2899/BI	264	21003/160/DIM/AU	040	21013/38/BI	282	30858/VE	484
2899/CO	264	21003/160/DIM/BI	040	21013/38/NE	282	30859/BI	484
2899/NE	264	21003/160/DIM/CU	040	21014/20/BI	282	30860/BI	484
2904/BI	296	21003/160/DIM/NE	040	21014/20/NE	282	30861/BI	484
2904/J/BI	296	21003/200/DIM/AU	040	21014/38/BI	282	30862/BI	484
2904/J/NE	296	21003/200/DIM/BI	040	21014/38/NE	282	30869/NE	214
2904/NE	296	21003/200/DIM/CU	040	21015/BI	198	30869/NE	218
2905/230/BI	292	21003/200/DIM/NE	040	21015/GI	198	30902	256
2905/230/NE	293	21003/300/DIM/AU	040	21015/NE	198	30902	258
2905/BI	292	21003/300/DIM/BI	040	30640	252	30903/BI	484
2905/NE	293	21003/300/DIM/CU	040	30640.1	252	40001/2700/AU	058
5142.1	329	21003/300/DIM/NE	040	30640.1/T	252	40001/2700/BI	058

INDICE PER CODICE / CODE INDEX

40001/2700/BM	058	40002/4000/AU	059	40003/SL/2700/NE	074	40007/BI	063
40001/2700/CU	058	40002/4000/BI	059	40003/SL/2700/OV	074	40007/BI	077
40001/2700/NE	058	40002/4000/BM	059	40003/SL/3000/AU	074	40007/BM	063
40001/2700/OV	058	40002/4000/CU	059	40003/SL/3000/BI	074	40007/BM	077
40001/3000/AU	058	40002/4000/NE	059	40003/SL/3000/BM	074	40007/CU	063
40001/3000/BI	058	40002/4000/OV	059	40003/SL/3000/CU	074	40007/CU	077
40001/3000/BM	058	40002/SL/2700/AU	073	40003/SL/3000/NE	074	40007/NE	063
40001/3000/CU	058	40002/SL/2700/BI	073	40003/SL/3000/OV	074	40007/NE	077
40001/3000/NE	058	40002/SL/2700/BM	073	40003/SL/4000/AU	074	40007/OV	063
40001/3000/OV	058	40002/SL/2700/CU	073	40003/SL/4000/BI	074	40007/OV	077
40001/4000/AU	058	40002/SL/2700/NE	073	40003/SL/4000/BM	074	40008.1/BI	063
40001/4000/BI	058	40002/SL/2700/OV	073	40003/SL/4000/CU	074	40008.1/BI	077
40001/4000/BM	058	40002/SL/3000/AU	073	40003/SL/4000/NE	074	40008/AU	063
40001/4000/CU	058	40002/SL/3000/BI	073	40003/SL/4000/OV	074	40008/AU	077
40001/4000/NE	058	40002/SL/3000/BM	073	40004.1/BI	062	40008/BI	063
40001/4000/OV	058	40002/SL/3000/CU	073	40004.1/BI	076	40008/BI	077
40001/SL/2700/AU	072	40002/SL/3000/NE	073	40004/AU	062	40008/BM	063
40001/SL/2700/BI	072	40002/SL/3000/OV	073	40004/AU	076	40008/BM	077
40001/SL/2700/BM	072	40002/SL/4000/AU	073	40004/BI	062	40008/CU	063
40001/SL/2700/CU	072	40002/SL/4000/BI	073	40004/BI	076	40008/CU	077
40001/SL/2700/NE	072	40002/SL/4000/BM	073	40004/BM	062	40008/NE	063
40001/SL/2700/OV	072	40002/SL/4000/CU	073	40004/BM	076	40008/NE	077
40001/SL/3000/AU	072	40002/SL/4000/NE	073	40004/CU	062	40008/OV	063
40001/SL/3000/BI	072	40002/SL/4000/OV	073	40004/CU	076	40008/OV	077
40001/SL/3000/BM	072	40003/2700/AU	060	40004/NE	062	40010/AU	064
40001/SL/3000/CU	072	40003/2700/BI	060	40004/NE	076	40010/AU	078
40001/SL/3000/NE	072	40003/2700/BM	060	40004/OV	062	40010/BI	064
40001/SL/3000/OV	072	40003/2700/CU	060	40004/OV	076	40010/BI	078
40001/SL/4000/AU	072	40003/2700/NE	060	40005.1/BI	062	40010/BM	064
40001/SL/4000/BI	072	40003/2700/OV	060	40005.1/BI	076	40010/BM	078
40001/SL/4000/BM	072	40003/3000/AU	060	40005/AU	062	40010/CU	064
40001/SL/4000/CU	072	40003/3000/BI	060	40005/AU	076	40010/CU	078
40001/SL/4000/NE	072	40003/3000/BM	060	40005/BI	062	40010/NE	064
40001/SL/4000/OV	072	40003/3000/CU	060	40005/BI	076	40010/NE	078
40002/2700/AU	059	40003/3000/NE	060	40005/BM	062	40010/OV	064
40002/2700/BI	059	40003/3000/OV	060	40005/BM	076	40010/OV	078
40002/2700/BM	059	40003/4000/AU	060	40005/CU	062	40011/AU	064
40002/2700/CU	059	40003/4000/BI	060	40005/CU	076	40011/AU	078
40002/2700/NE	059	40003/4000/BM	060	40005/NE	062	40011/BI	064
40002/2700/OV	059	40003/4000/CU	060	40005/NE	076	40011/BI	078
40002/3000/AU	059	40003/4000/NE	060	40005/OV	062	40011/BM	064
40002/3000/BI	059	40003/4000/OV	060	40005/OV	076	40011/BM	078
40002/3000/BM	059	40003/SL/2700/AU	074	40007.1/BI	063	40011/CU	064
40002/3000/CU	059	40003/SL/2700/BI	074	40007.1/BI	077	40011/CU	078
40002/3000/NE	059	40003/SL/2700/BM	074	40007/AU	063	40011/NE	064
40002/3000/OV	059	40003/SL/2700/CU	074	40007/AU	077	40011/NE	078

40011/OV	064	40027/BI	103	40079.1	162	40108	454
40011/OV	078	40028/BI	103	40080	154	40109	454
40013/AU	062	40030/NE	236	40080.1	162	40110	454
40013/AU	076	40030/NE	244	40081/NE	170	40111	442
40013/BI	062	40031/NE	236	40081/NE	172	40112.1/BI	160
40013/BI	076	40031/NE	244	40081/NE	174	40112.1/VE	160
40013/BM	062	40032/NE	236	40082/NE	170	40112/BI	154
40013/BM	076	40032/NE	244	40082/NE	174	40112/BI	158
40013/CU	062	40033/NE	236	40083/NE	170	40112/BI	160
40013/CU	076	40033/NE	244	40083/NE	174	40112/VE	154
40013/NE	062	40034/NE	236	40084/NE	171	40112/VE	158
40013/NE	076	40036/NE	237	40084/NE	174	40112/VE	160
40013/OV	062	40037/NE	236	40085/NE	170	40114.1/NE	244
40013/OV	076	40037/NE	244	40085/NE	174	40114/BZ	180
40014/AU	065	40047/BI	103	40086.1/BI	329	40114/NE	172
40014/BI	065	40048/BI	103	40086.1/NE	329	40114/NE	180
40014/BM	065	40049/NE	236	40086/BI	329	40114/NE	237
40014/CU	065	40052/NE	236	40086/NE	329	40115/NE	170
40014/NE	065	40053/2700/BI	102	40087/NE	272	40116/NE	170
40014/OV	065	40053/4000/BI	102	40087/NE	276	40117/NE	171
40015/AU	065	40053/BI	102	40087/NE	280	40117/NE	174
40015/BI	065	40054/NE	472	40087/NE	282	40118/NE	171
40015/BM	065	40059/AN	428	40088/AU	048	40118/NE	172
40015/CU	065	40059/CO	428	40088/BI	048	40119	156
40015/NE	065	40060/AN	428	40088/CU	048	40120	156
40015/OV	065	40060/CO	428	40088/NE	048	40121	156
40020/2700/BI	102	40061/AN	428	40091/AU	048	40122	156
40020/4000/BI	102	40061/CO	428	40091/BI	048	40123.1/BZ	180
40020/BI	102	40062/AN	428	40091/CU	048	40123.1/NE	180
40021/2700/BI	102	40062/CO	428	40091/NE	048	40123/BZ	180
40021/4000/BI	102	40065	476	40093/AU	048	40123/NE	180
40021/BI	102	40072	180	40093/BI	048	40124/BI	104
40022/2700/BI	102	40074.1/GR	162	40093/CU	048	40124/DIM/BI	104
40022/4000/BI	102	40074.2/GR	158	40093/NE	048	40128/AU	049
40022/BI	102	40074.3/GR	164	40096	049	40128/BI	049
40023.1/BI	104	40074/GR	154	40097/AU	049	40128/CU	049
40023.1/DIM/BI	104	40075	154	40097/BI	049	40128/NE	049
40023/BI	104	40075	158	40097/CU	049	40129/NE	171
40023/DIM/BI	104	40075	164	40097/NE	049	40129/NE	172
40024.1/BI	104	40076	154	40101/NE	171	40130/NE	171
40024.1/DIM/BI	104	40076	162	40101/NE	172	40130/NE	172
40024/BI	104	40077	154	40102/NE	170	40132/GR	158
40024/DIM/BI	104	40077.1	162	40102/NE	174	40132/GR	164
40025/BI	104	40078	154	40105/GR	454	40133/GI	144
40025/DIM/BI	104	40078.1	162	40106	454	40133/GR	144
40026/BI	103	40079	154	40107	454	40133/VE	144

INDICE PER CODICE / CODE INDEX

40134/GR	160	40159	162	40182/OV	063
40135/2700/BI	102	40160/NE	237	40182/OV	077
40135/4000/BI	102	40161/NE	174	40192	418
40135/BI	102	40162/NE	174	40193/SL/3000/AU	082
40137/NE	236	40163/NE	170	40193/SL/3000/BI	082
40137/NE	244	40163/NE	174	40193/SL/3000/BM	082
40147.1/BI	104	40164	276	40193/SL/3000/CU	082
40147.1/DIM/BI	104	40164	282	40193/SL/3000/NE	082
40147/BI	104	40165	276	40193/SL/3000/OV	082
40147/DIM/BI	104	40165	282	40193/SL/AU	082
40148/14/BI	384	40166	410	40193/SL/BI	082
40148/14/NE	384	40166	436	40193/SL/BM	082
40148/35/BI	384	40167/NE	180	40193/SL/CU	082
40148/35/NE	384	40168.1/GI	331	40193/SL/NE	082
40149/14/BI	384	40168.2/GI	331	40193/SL/OV	082
40149/14/NE	384	40168/GI	331	40194/AU	082
40149/35/BI	384	40169.1/NE	472	40194/BI	082
40149/35/NE	384	40169.2/NE	472	40194/BM	082
40150/14/BI	384	40169/NE	472	40194/CU	082
40150/14/NE	384	40171.1/BI	396	40194/NE	082
40150/35/BI	384	40171.1/NE	396	40194/OV	082
40150/35/NE	384	40172.1/AR	396	40195/AU	082
40151/14/BI	384	40172.1/BI	396	40195/BI	082
40151/14/NE	384	40172.1/BL	396	40195/BM	082
40151/35/BI	384	40172.1/GI	396	40195/CU	082
40151/35/NE	384	40173.1/AR	396	40195/NE	082
40152/14/BI	384	40173.1/BI	396	40195/OV	082
40152/14/NE	384	40173.1/BL	396	40196/BI	258
40152/35/BI	384	40173.1/GI	396	40197/BI	258
40152/35/NE	384	40174.1/AR	396	40198/BI	258
40153/14/BI	385	40174.1/BI	396	40204.1	136
40153/14/NE	385	40174.1/BL	396	40204.1	170
40153/35/BI	385	40174.1/GI	396	40204.1	172
40153/35/NE	385	40175	522	40204.1	180
40154/14/BI	385	40181/AN	428	40204.1	190
40154/14/NE	385	40181/CO	428	40204.1	218
40154/35/BI	385	40182/AU	063	40204.1	237
40154/35/NE	385	40182/AU	077	40204.1	244
40155/BI	385	40182/BI	063	40205	448
40155/NE	385	40182/BI	077	40828/L/1/BI	128
40156/BI	385	40182/BM	063	40829/L/1/BI	128
40156/NE	385	40182/BM	077	40830/GR	129
40157/BI	385	40182/CU	063	40831/GR	129
40157/NE	385	40182/CU	077	40834	129
40158.1/NE	244	40182/NE	063	40835/BI	129
40158/NE	237	40182/NE	077	40854/L/1/BI	128

projects

PROJECTS





PROJECTS





PROJECTS





PROJECTS



FINITURE / FINISHING

2003

AN antracite opaco / matt anthracite RAL 7021

AMANITA

GR grigio cemento / concrete grey

BICONICA POL

polietilene bianco / white polyethylene

BOLETO

CO corten goffrato / textured corten

BOWL

polietilene bianco / white polyethylene

BRICK

BI bianco opaco / matt white RAL 9003
NE nero opaco / matt black RAL 9005

BRUCO

AN antracite goffrato / textured anthracite RAL 7021
CO corten goffrato / textured corten

CALABRONE

NE nero opaco / matt black RAL 9005

CALABRONENET

NE nero opaco / matt black RAL 9005

CIP

BI bianco opaco / matt white RAL 9003
NE nero opaco / matt black RAL 9005

CIRCULAR POL

BI polietilene bianco / white polyethylene

CIRCULAR SLIM

AU oro perlato opaco / matt pearl gold RAL 1036
BI bianco opaco / matt white RAL 9003
CU rame goffrato opaco / matt copper

CIULIFRULI

AZ polietilene azzurro / light blue polyethylene
BI polietilene bianco / white polyethylene
GI polietilene giallo / yellow polyethylene
RO polietilene rosso / red polyethylene
VE polietilene verde / green polyethylene

COLIBRÌ 40081

NE nero opaco / matt black RAL 9005

COLIBRÌ 2080

BZ bronzo opaco / matt bronze
NE nero opaco / matt black RAL 9005

COLIBRÌ 2312-21015

BI bianco lucido / glossy white RAL 9003
GI giallo lucido / polished yellow RAL 1012
NE nero opaco / matt black RAL 9005

COLIBRÌ 2290

NE nero opaco / matt black RAL 9005
AU oro perlato opaco / matt pearl gold RAL 1036

COLIBRÌ 1406

NE anodizzato nero

COLIBRÌ 1421

NE nero opaco / matt black RAL 9005

COLIBRÌ 2087

NE nero opaco / matt black RAL 9005

COLIBRÌ 2070

NE nero opaco / matt black RAL 9005

COLIBRÌ 1410

NE nero opaco / matt black RAL 9005
AU oro perlato opaco / matt pearl gold RAL 1036

COLIBRÌ 2278

NE nero opaco / matt black RAL 9005

COLIBRÌ 2320

NE nero opaco / matt black RAL 9005
GI giallo lucido / polished yellow RAL 1012

COLIBRÌ 811/T/H

NE nero opaco / matt black RAL 9005

CORONA M

BI metacrilato bianco / white methacrylate

CYBORG CEMENTO

GR grigio cemento / concrete grey
GI cemento giallo ocra / concrete yellow ochre

CYBORG BIG

N/BI polietilene bianco / white polyethylene
VE polietilene verde / green polyethylene
RO polietilene rosso / red polyethylene

EYE

BI bianco opaco / matt white RAL 9003
NE nero opaco / matt black RAL 9005

FROG

BL polietilene blu ottanio / octanium blue polyethylene
AR polietilene arancio / orange polyethylene
GI polietilene giallo / yellow polyethylene
AN polietilene antracite / anthracite polyethylene

GLOU GLOU POL

BI polietilene bianco / white polyethylene

GRILLO

NE anodizzato nero / anodized black RAL 9005

HUSH

BI tessuto bianco / white fabric
VE tessuto verde / green fabric
GR grigio opaco / matt grey RAL 9006

KIKI

corpo lampada
NE polietilene nero / black polyethylene diffusore
polietilene bianco / white polyethylene

KOALA

GR grigio cemento / concrete grey

KOKO UNO

AU oro perlato opaco / matt pearl gold RAL 1036
BI bianco opaco / matt white RAL 9003
CO corten opaco / matt corten
NE nero opaco / matt black RAL 9005

LADY GALALA

corpo lampada / lamp body
BI bianco opaco / matt white RAL 9003
NE nero opaco / matt black RAL 9005
diffusori / diffusers
BI metacrilato bianco / white methacrylate
AR metacrilato arancio / orange methacrylate
GI metacrilato giallo / yellow methacrylate
BL metacrilato blu / blue methacrylate

LENT

GI tessuto giallo / yellow fabric
GR tessuto grigio / grey fabric
VE tessuto verde / green fabric

LOOP

AU oro perlato opaco / matt pearl gold RAL 1036
BI bianco opaco / matt white RAL 9003
CU rame opaco / matt copper
NE nero opaco / matt black RAL 9005

LUNA

BI bianco opaco / matt white RAL 9003

LUNAOP

AU oro perlato opaco / matt pearl gold RAL 1036
BI bianco opaco / matt white RAL 9003
BM bronzo materico/rough bronze
CU rame opaco / matt copper
NE nero opaco / matt black RAL 9005
OV ottone vintage/vintage brass

MAMBA

BI polietilene bianco / white polyethylene

NUVOLE VAGABONDE

BI policarbonato bianco / white polycarbonate

OLYMPIC

BI bianco opaco / matt white RAL 9003
AN antracite opaco / matt anthracite RAL 7021

PISTILLO

BI PMMA bianco / white

POLO

AN antracite bucciato / textured anthracite RAL 7021
CO corten bucciato / textured corten

PONT

GR grigio cemento / concrete grey

R11

AN antracite opaco / matt anthracite RAL 7021
BI bianco opaco / matt white RAL 9003

R19

NE nero opaco / matt black RAL 9005

SISTEMA U

BI bianco opaco / matt white RAL 9003
NE nero opaco / matt black RAL 9005

SOUND

GR grigio opaco / matt grey RAL 9006

TRILLY

polietilene bianco / white polyethylene



ART DIRECTION

Emiliana Martinelli

PHOTOGRAPHY

Benvenuto Saba
Simone Baldocchi
Emiliana Martinelli
Marco Ghilarducci
Bruno Malegue
Stefano Anzini
Saverio Lombardi Vallauri
Donal Murphy Photography
Andrea Anoni
Vincenzo Oliviero
Luigi Rinaldelli
Lampfeber

POST PRODUCTION

per foto B. Saba
Francesco Bonuccelli,
Andrea Benassi,
Laura Bartelloni

LAYOUT

Stefano Citti

3D VISUALIZATION

Tredistudio
Bieffe Rendering
Enrico Capanni
Massimo Farinatti
Kalin Gemignani
Marco Ghilarducci
PLS design - Lorenzo Perini

EDITING OF TEXT

Emiliana Martinelli
Giovanni Silvano
Marco Ghilarducci

PRINTING IN ITALY

Imoco - Treviso

EDITION

luglio 2023 © all rights reserved



martinelli luce spa via Teresa Bandettini 55100 Lucca - Italy
+39 0583 418315 | www.martinelliluce.it | info@martinelliluce.it
showroom | via S. Lucia 9, 55100 Lucca | + 39 0583 496254 | showroom@martinelliluce.it



martinelliluce.it