

AUSTRIA | MOLTO LUCE GMBH

HEADQUARTERS WELS
Office & Showroom
Europastraße 45
4600 Wels
T: +43 7242 698-0
M: office@moltoluce.com

VIENNA
Office & Showroom
Vorarlberger Allee 28
1230 Vienna
T: +43 1 6160300
M: office.wien@moltoluce.com

GRAZ
Office
Robert-Viertl-Straße 2
8055 Graz
T: +43 316 672525-0
M: office.graz@moltoluce.com

INNSBRUCK
Office
Orbis Office, Resselstraße 33 / Top 5
6020 Innsbruck
T: +43 512 345688
M: office.innsbruck@moltoluce.com

GERMANY | MOLTO LUCE GMBH

MUNICH
Office & Showroom
Walter-Gropius-Straße 23
80807 Munich
T: +49 89 4520565-0
M: office.muenchen@moltoluce.com

COLOGNE
Office & Showroom
Gut Maarhausen, Eiler Straße 3v
51107 Cologne
T: +49 221 222882-0
M: office.koeln@moltoluce.com

HAMBURG
Office & Showroom
Wandsbeker Allee 77
22041 Hamburg
T: +49 40 2847850-1
M: office.hamburg@moltoluce.com

ITALY | MOLTO LUCE srl

BRESCIA
Office
Viale Duca D' Aosta 28
25121 Brescia
T: +39 030 2400679
M: office.brescia@moltoluce.com

SWITZERLAND | MOLTO LUCE AG

LENZBURG
Office
Niederlenzerstraße 25
5600 Lenzburg
T: +41 62 885 70 30
M: office.lenzburg@moltoluce.com

FRANCE | MOLTO LUCE GMBH

STRASBOURG
Office
5 allée d' Helsinki
67300 Schiltigheim
T: +43 664 88846846
M: ingrid.bolley@moltoluce.com

www.moltoluce.com

COLLECTED EDITION
2022 | 23

LIGHT FOR HIGH QUALITY
ARCHITECTURE

MOLTO LUCE®

V_0_025

MOLTO LUCE®













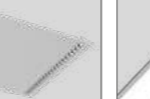
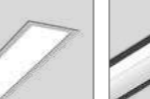

AUFBAU LEUCHTEN UND STRAHLER / SURFACE LUMINAIRES AND SPOTS

 2 GO SD 294-295	 BIDO SDI / SD 012-021	 BINA SDI / SD 022-031	 CHARM SD 038-039	 DASH 2 SD 222-223	 GRID SD 252-253	 LOG 50 SD 110-115	 LOG OUT 2.1 SD 128-131	 MICA IP44 SD 260-261	 PARI SD 262-263	 RIDE SD 086-087	 RIDE RING SD 082-083	 RINO SD 032-033	 THE LINE SD 176-177	 TRIGGA 1/2 SD 230-231	 VALO SDI 172-173	 VIBO SD 258-259	 VOLTO COPERTO SD 264-265
--	--	--	---	--	---	--	---	---	--	--	---	--	--	--	---	--	---



PENDELLEUCHTEN / PENDANT LUMINAIRES

 ACOUSTIC PD 214-219	 BIDO PDI / PD 012-021	 BINA PDI / PD 022-031	 CHARM PDI / PD 040-041	 LENS PDI 198-201	 LOG 50 PDI / PD 110-115	 LOG 2.1 PDI / PD 134-145	 LOG OUT UP/DOWN PDI 156-157	 MAGNETICS PDI 062-063	 RIDE PD 092-093	 RIDE RING PD 084-085	 RINO PDI / PD 034-037	 SYSTEM 01.1 PDI 204-205	 TOUCH DOWN PD 334-335	 TRIGGA PD 234-237	 VALO HV PDI VALO PDI 168-171
--	--	--	---	---	---	---	--	--	--	---	--	--	--	--	---

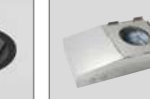
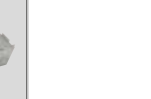



EINBAU LEUCHTEN UND STRAHLER / RECESSED LUMINAIRES AND SPOTS

 2 GO R 296-297	 ARTIS R 286-289	 BIDO R 012-021	 BINA R 022-031	 BLINDSPOT R 238-243	 GET R 328-331	 GRID R 246-251	 INTERO R 208-213	 LOG 50 R 110-115	 LOG IN 2.1 R 146-151	 MOVA R MOVA S R 266-275	 NOW R ONLY R 320-327	 RIDE R 094-101	 RIDE SPOT R 244-245	 SAVO R 312-319	 TRIGGA R 228-229	 VIBO R 254-257	 RECESSED HOUSING 332-333
---	--	---	---	--	---	---	---	---	---	--	---	---	--	---	---	---	---

WANDLEUCHTEN / WALL LUMINAIRES

 LOG OUT UP/DOWN W 158-159	 MAGNETICS W 064-065	 RIDE BLIND SI 090-091	 TRIGGA W 232-233
--	--	--	---

TISCH- UND STEHLEUCHTEN / TABLE- AND STAND LUMINAIRES

 CONCEPT F 180-187	 LENS F 188-197	 MAGNETICS F 066-067	 SYSTEM 01.1 F 202-203	 SYSTEM 02.1 F 206-207
--	---	--	--	--



3-PHASEN SCHIENENSTRAHLER UND LEUCHTEN / 3-PHASE TRACK SPOTS AND LUMINAIRES

 2 GO TRACK 290-293	 ARTIS TRACK 280-285	 DASH 2 TRACK 220-221	 LOG OUT 2.1 TRACK 154-155	 MOVA S TRACK 266-275	 MOVA M TRACK 266-275	 MOVA S GU10 TRACK 276-277	 SHOPSTAR LEAN TRACK 298-299	 TRAIL TRACK 300-301	 VALO TRACK 166-167	 VARIDO TRACK 302-305	 3-PHASE TRACK 306-311
---	--	---	--	---	--	--	--	--	---	---	--

PROFILSYSTEME / PROFILE SYSTEMS

 CHARM SYSTEM 042-045	 LOG 2.1 SYSTEM 116-123	 LOG 50 SYSTEM 102-109	 LOG UP/DOWN SYSTEM 160-161	 MAGNETICS SYSTEM 054-061	 RIDE SYSTEM 068-075	 THE LINE SYSTEM 178-179	 VALO SYSTEM 174-175
---	---	--	---	---	---	--	--

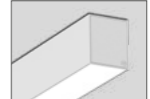
AUSSENLEUCHTEN / OUTDOOR LUMINAIRES

 LOG IN 2.1 IP54 R 152-153	 LOG OUT 2.1 IP54 SD 132-133	 RIDE IP54 R 096-097	 RIDE IP54 SD 088-089
--	--	--	---

ARCHITECTURAL

AUFBAU LEUCHTEN UND STRAHLER / SURFACE LUMINAIRES AND SPOTS

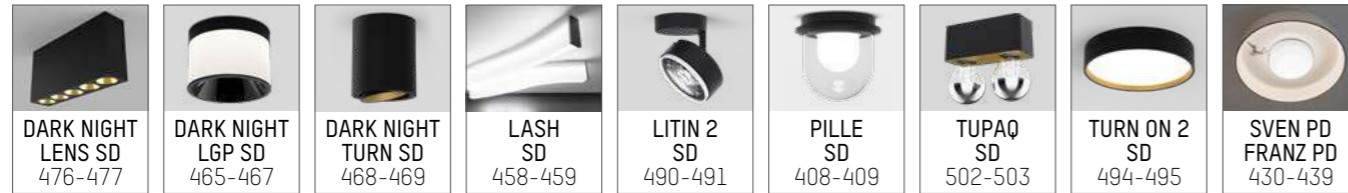

PENDELLEUCHTEN / PENDANT LUMINAIRES



EINBAU LEUCHTEN UND STRAHLER / RECESSED LUMINAIRES AND SPOTS

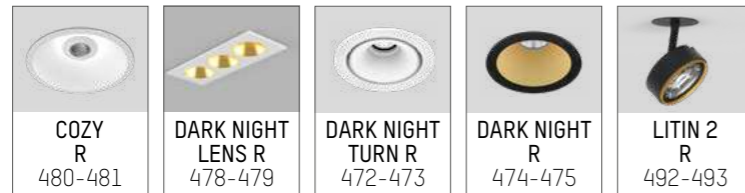

WANDLEUCHTEN / WALL LUMINAIRES



TISCH- UND STEHLEUCHTEN / TABLE- AND STAND LUMINAIRES

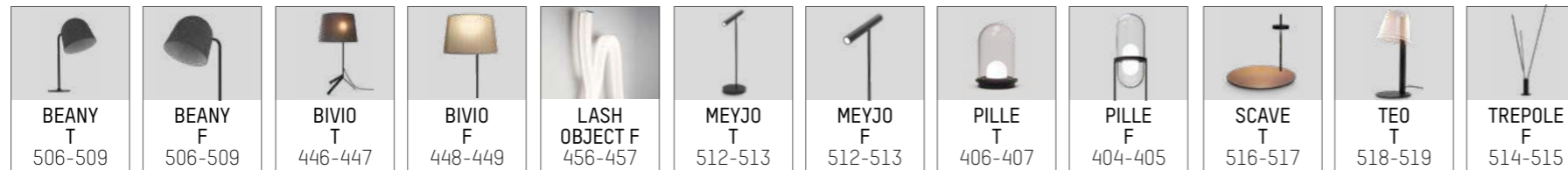

3-PHASEN SCHIENENSTRAHLER UND LEUCHTEN / 3-PHASE TRACK SPOTS AND LUMINAIRES



VOLARE 2-PHASEN SCHIENENSTRAHLER UND LEUCHTEN / VOLARE 2-PHASE TRACK SPOTS AND LUMINAIRE



AUSSENLEUCHTEN / OUTDOOR LUMINAIRES



DECORATIVE



**Eine Leidenschaft für alle Fälle.
Lichtmagie seit 1981.**

In einer so kurzlebigen Zeit wie heute, ließe sich vermuten, dass Leidenschaften kommen und gehen. Bei Molto Luce trifft das so gar nicht zu, denn der perfekten Lichtatmosphäre schenken wir schon seit der Unternehmensgründung 1981 unsere volle Aufmerksamkeit.

Uns begeistern die vielen Möglichkeiten, die professionelle Beleuchtung mit sich bringt. Wir sind überwältigt von der Magie, die durch Licht entsteht. Tag für Tag sind wir aufs Neue verzaubert, welche Wirkung man durch die geeignete Lichtlösung erzielen kann.

Unsere Produkte, unsere Planungen und unsere Partnerschaften sind die beste Basis für erfolgreiche Arbeit, für perfekte Beleuchtungslösungen. Dabei ist uns bewusst, dass jedes Projekt seinen eigenen Fokus hat und deshalb auch sein individuelles Lichtkonzept benötigt. Mal sanft und zurückhaltend, mal aktivierend und kräftig, mal technisch und geradeheraus, mal dekorativ und mit fröhlicher Leichtigkeit... Licht geht viele Wege mit und zeigt sich immer wieder von seiner effektivsten Seite.

Aufmerksam zuhören, kreativ und konzentriert denken, zielführend planen und ein zuverlässiger Partner in der Abwicklung sein, sind jene Guidelines, die wir uns bei jedem Projekt als oberste Prämissen vor Augen halten. Unsere Ideen mit den Vorstellungen der Auftraggeber in harmonischen Einklang zu bringen, ist ein Ziel, das wir mit all unserem Know-how und all unserer Begeisterung für das Licht, konsequent und ebenso erfolgreich verfolgen.

**Passion in any case.
Lighting magic since 1981.**

In a time as fleeting as today, we might assume that passions come and go. This is definitely not the case at Molto Luce, as we have been giving our full attention to creating the perfect lighting atmosphere since the company was founded in 1981.

We are excited by the many possibilities that come with professional lighting. We are overwhelmed by the magic created by light. Every day, we are enchanted over and over again by the effects that can be achieved through the right lighting solution.

Our products, our plans and our partnerships are the best basis for successful work, for perfect lighting solutions. We know that every project has its own focus and therefore also needs its own individual lighting concept. Gentle and restrained, stimulating and powerful, technical and straightforward, decorative and with cheerful brightness... light moves in many ways and is always shown from its most striking side.

Listening attentively, thinking creatively and deeply, planning with a focus and being a reliable partner during execution of projects are all guidelines that we keep at the forefront for each project. Creating a harmonious balance between our ideas and the client's suggestions is a goal that we can achieve both consistently and successfully with all our know-how and all our enthusiasm.

Kompetenz in Technik, Design, Planung und Projektentwicklung. Grenzenlos.

Als Hersteller von Highquality-Produkten sind wir über den gesamten Leistungsprozess hinweg in die Magie des Lichtmachens involviert. Daraus ergeben sich viele Vorteile für unsere Partner, denn wir verstehen die Technik ebenso wie die Planung. Wir entwickeln Produkte von technisch höchstem Anspruch und wissen zudem auch, wie man diese gekonnt einsetzen muss, um die perfekten Ergebnisse in Lichtwirkung und -stimmung zu erzielen. Davon profitieren unsere Partner und Kunden. Weltweit.

Expertise in technology, design, planning and implementing projects. Without borders.

As a manufacturer of high-quality products, we are involved throughout the entire service process, in the magic of making light. This gives our partners many advantages, as we understand technology as much as planning. We develop products of the highest technical standard and also know how these should be skilfully used to achieve perfect results for the lighting effect and mood. In this way, our partners and clients benefit. Worldwide.

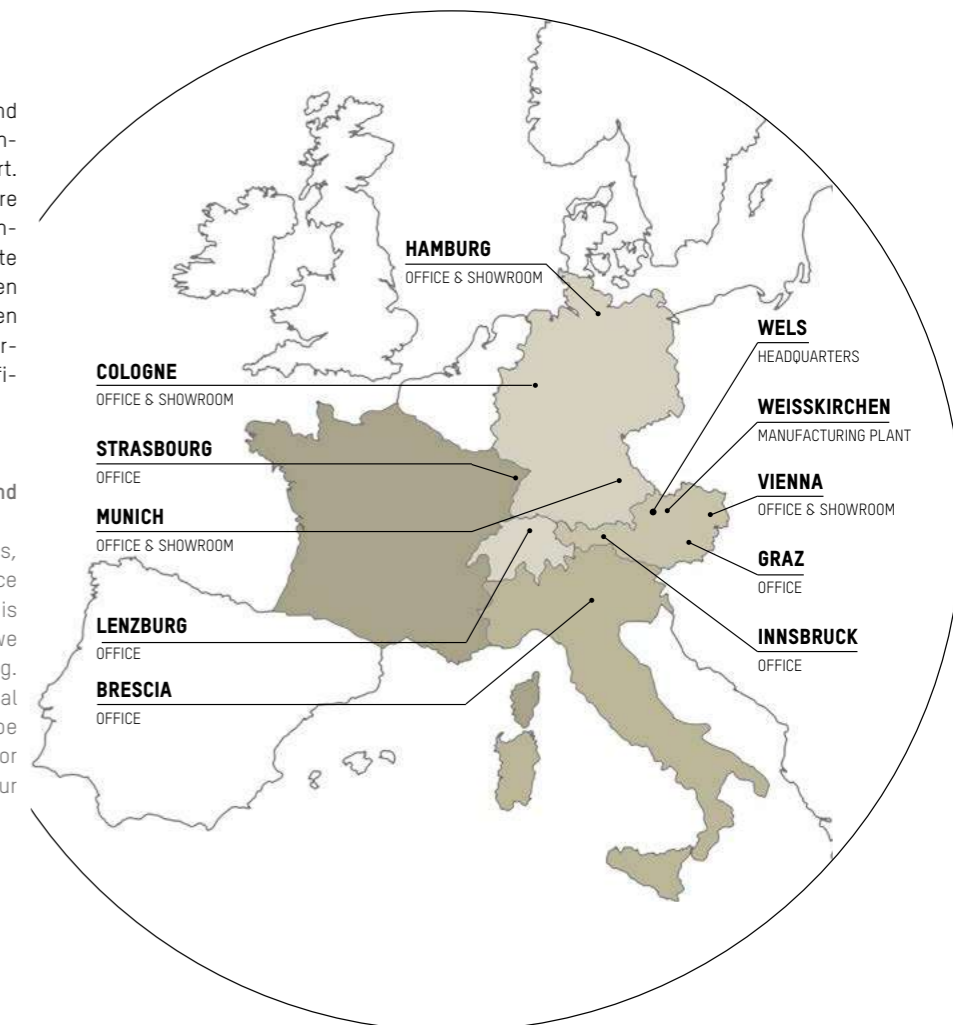

Licht im Einklang mit der Natur.

Als Unternehmen übernehmen wir Verantwortung: für unsere Mitarbeiter, unsere Produkte, unsere Projekte, unsere Entscheidungen und unser Handeln. Wir verpflichten uns zu einem fairen Miteinander und einem verantwortungsbewussten Umgang mit den Ressourcen dieser Welt.

Wir leben in einem wunderschönen Land, umgeben von Bergen, Wäldern und Seen. Wir genießen die frische Luft, das herrliche Trinkwasser und die wunderbare Tier- und Pflanzenwelt. All das möchten wir auch für weitere Generationen bewahren.

Das Bewusstsein für nachhaltiges Handeln zu schärfen und in all unseren Prozessen bestmöglich zu leben, ist unser Auftrag. Bei großen Investitionsentscheidungen betrachten wir nicht nur die monetären Kosten, sondern lassen auch den Nachhaltigkeitsaspekt miteinfließen. Entscheidungen für ressourcenschonende Produktionsanlagen und energieeffiziente Gebäudetechnik sind nur die offensichtlichsten Beispiele dafür. Alle neuen Gebäude werden darüber hinaus mit leistungsstarken Photovoltaik-Anlagen ausgerüstet, die einen Großteil des Strombedarfs abdecken können. Unsere neue Produktionshalle am Standort Weißkirchen ist bereits zu 100% CO₂-neutral.

Auch bei der Auswahl und dem Monitoring unserer Zulieferer und deren Leistungen und Produkte legen wir großes Augenmerk auf den ökologischen Fußabdruck, den sie hinterlassen. Wir präferieren verantwortungsbewusste Unternehmen, die selbst einen nachvollziehbaren Beitrag zum Schutz der Umwelt leisten. Zudem optimieren wir laufend die nötigen Transportwege und setzen noch stärker als bisher auf europäische Lieferanten.

Wir selbst entwickeln Beleuchtung, die den Verbrauch von Strom und CO₂ reduziert, suchen auch nach Lösungen, LEDs noch effizienter zu nutzen bzw. launchen wir Produkte mit wechselbaren LEDs. Unsere Produkte verpacken wir vorwiegend in maßgenauen Kartons, wodurch wir deutlich Verpackungs- und Füllmaterial einsparen können. Wir achten darauf, wo immer es möglich ist, Kunststoffe zu vermeiden. Wir verzichten wenn möglich, auf ein Bandrolieren mit Kunststoffbändern bzw. ein Verwenden von Stretchfolien zum Umwickeln von Kommissionen.

Doch auch in den kleinen alltäglichen Handlungen unserer Mitarbeiter sehen wir ein unschätzbare Potenzial für sinnvolle Ressourcen-Einsparung. Deshalb sind wir weltmeisterlich im Trennen von Müll und setzen auf E-Mobilität und Recycling.

We care. Wir kümmern uns um unsere Umwelt.

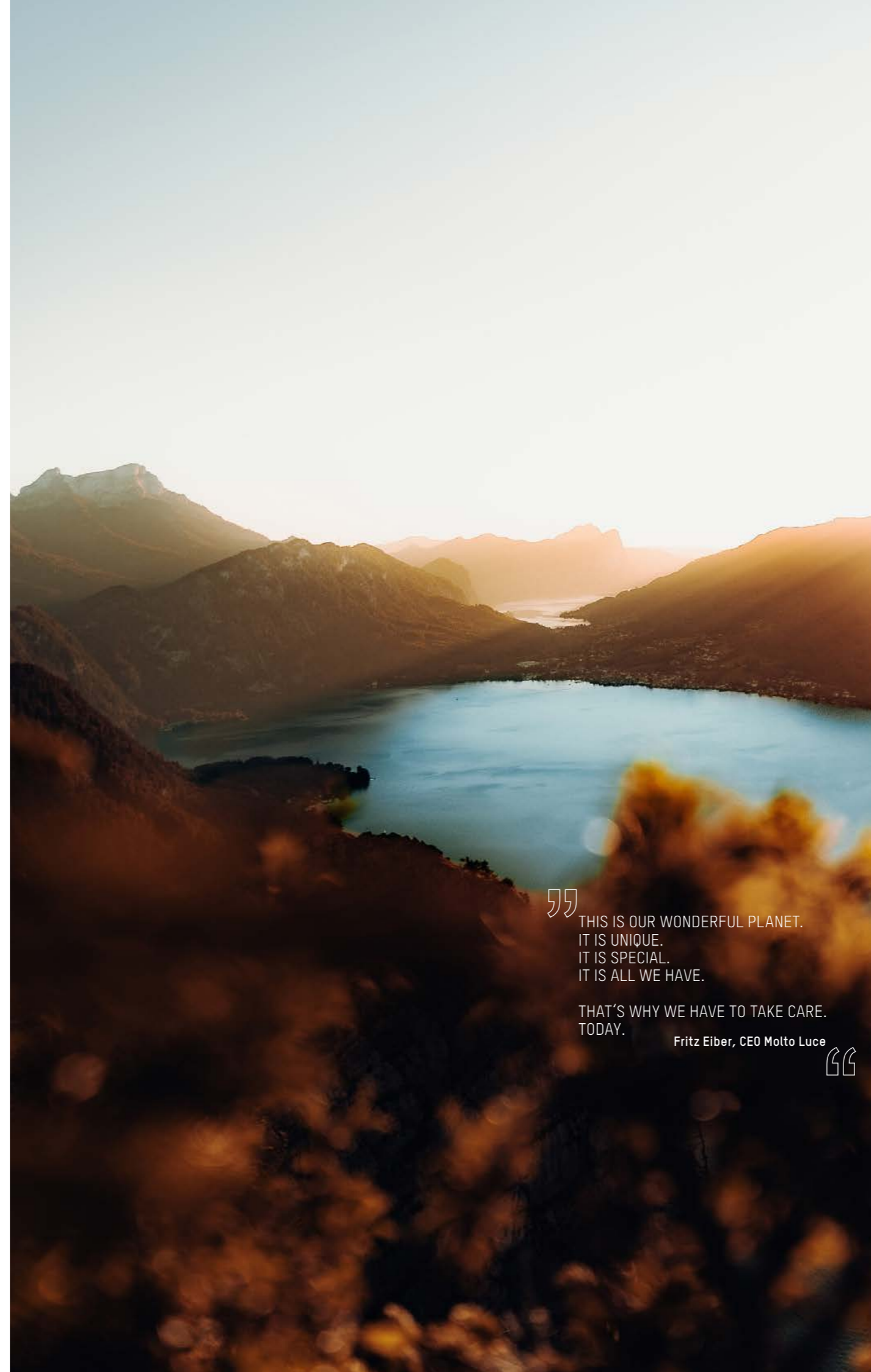

” THIS IS OUR WONDERFUL PLANET.
IT IS UNIQUE.
IT IS SPECIAL.
IT IS ALL WE HAVE.

THAT’S WHY WE HAVE TO TAKE CARE.
TODAY.

Fritz Eiber, CEO Molto Luce



Light in harmony with nature.

We assume responsibility as a company: for our staff, our products, our projects, our decisions and our actions. It is our duty to interact fairly and deal responsibly with this world’s resources.

We live in a beautiful country, surrounded by mountains, forests and lakes. We enjoy fresh air, glorious drinking water and marvellous fauna and flora. We would also like to preserve all of these things for future generations.

It is our job to heighten awareness of sustainable action and to live as well as possible in all our processes. When making major investment decisions, we do not only take financial costs into account, but the sustainability aspect is also involved. Opting for resource-conserving production plants and energy-efficient building technology is only the most public example of this. All new buildings are also equipped with efficient photovoltaic systems, which can cover a large part of the power requirement. Our new production hall at the Weißkirchen site is already 100% CO₂ neutral.

When selecting and monitoring our suppliers and their services and products, we also pay plenty of attention to the ecological footprint that they leave behind. We favour responsible companies who themselves make a visible contribution to protecting the environment. We also continually optimise the necessary transport routes and rely on European suppliers much more than before.

We ourselves are developing lighting that reduces the consumption of power and CO₂, and are also searching for solutions in using LEDs more efficiently and/or launching products with changeable LEDs. We mainly package our products in tailor-made boxes, which enables us to save significant amounts of packaging and filling material. We make sure to avoid plastics whenever possible. When possible, we also aim to avoid banding with plastic bands and/or using stretch film to wrap commissions.

However, we also see unlimited potential for practical conservation of resources in the smaller daily activities of our staff. We are therefore world champions in separating waste and rely on e-mobility and recycling.

We care. We look after our environment.

Farben, Quelle der Kreativität.

Gestalterische Freiheit ist enorm wichtig, um der planerischen Kreativität Ausdruck verleihen zu können. Architektonische Konzepte werden mit Feingefühl auf die persönlichen Vorlieben der Auftraggeber, auf die eingesetzten Materialien und definierten Styles, oder im Bereich von Corporate Architecture auf Elemente der Unternehmensidentität, abgestimmt. Leuchten müssen sich passend in den architektonischen Rahmen einfügen, manches Mal auch farblich.

Colours, a source of creativity.

Freedom of design is extremely important in expressing creativity during the planning phase. Architectural concepts are sensitively tailored to the personal preferences of the client, to the materials used and defined styles or, in the area of corporate architecture, to elements of the corporate identity. Luminaires must fit into the architectural framework, sometimes also in terms of colour.

Individual Colours.

Einzigartige Farbsynergien zwischen Lichtlösung und Architektur können am besten durch **Individual Colours** geschaffen werden. Individual Colours bieten absolute Farbtrennung und stehen für höchsten Individualisierungsgrad. Leuchten können farblich perfekt auf ein kreatives Raumkonzept oder Corporate Design-Vorgaben abgestimmt werden. Ihr Wunsch-RAL-Ton ist schon ab Stückzahl 1 realisierbar. Individual Colours lassen die Grenzen des Unmöglichen verschwinden.

Unique colour synergies between lighting solution and architecture can best be created with **Individual Colours**. Individual Colours provide absolute freedom of colour and provide the highest level of individualisation. Lights can be customised with the perfect colours to suit a creative room concept or corporate design project. Your ideal RAL shade can be implemented from a quantity of 1. Individual Colours make the boundaries of the impossible disappear.

Haben Sie Freude an unserer neuen Farbwelt.
Enjoy our new world of colours.

Core Colours.

Schwarz, Weiß und Grau/Aluminium spielen bei Molto Luce als **Core Colours** die führende Rolle. Dezent und zurückhaltend fügen sie sich in jede Art von Architektur ein. Ohne großes Augenmerk auf die Lichtlösung an sich zu ziehen. Core Colours sind neutral und bedeuten dauerhafte Gültigkeit.

Black, white and grey/aluminium play the leading role at Molto Luce as **Core Colours**. Discreet and restrained, they blend into any type of architecture. They do not draw too much attention to the lighting solution. Core Colours are neutral, signifying lasting validity.



Qualität in Farbe.

Mit der Inbetriebnahme unserer modernen, umweltfreundlichen Pulverbeschichtung am österreichischen Produktionsstandort heben wir den Individualisierungsgrad unserer Produkte auf einen neuen, deutlich höheren Level. Der gesamte Beschichtungsprozess inklusive strengen Kontrollen erfolgt im Haus, wodurch wir unsere gewohnt hohe Qualität auch im Bereich Farbe sicherstellen. Zusätzlich profitieren Kunden von höherer Flexibilität, optimierten Lieferzeiten und attraktiver Preisgestaltung.

Bei den verwendeten Pulvern setzen wir auf hochwertige Produkte europäischer Lieferanten. Qualitätspulver der Marke TIGER COATINGS und AKZO NOBEL INTERPON sind die Sicherheit für enge Farben- und Chargen-Konstanz, Umweltfreundlichkeit, Nachhaltigkeit und kurze Beschaffungswege.

Quality in colour.

We are taking the level of individualisation for our products to a new, even higher level with the commissioning of our state-of-the-art, environmentally friendly powder coating at the Austrian production site. The entire coating process, including strict controls, is carried out in-house, so that we can also guarantee our usual high quality in the area of colours. Clients also benefit from higher flexibility, optimised delivery times and attractive pricing.

Creative Colours.

Mit den charmanten **Creative Colours** entspricht Molto Luce dem Trend nach farbigen Akzenten in der Architektur. Basierend auf den jährlich vom internationalen Trend-Institut WGSN (Worth Global Style Network) veröffentlichten Forecasts, entspricht die Farbpalette einer kuratierten, nachhaltigen Empfehlung von echten Profis. Ob Beerenblau, Merlot oder Hochlandgrün... unsere Creative Colours harmonieren perfekt mit unserem Produktsortiment und gleichzeitig auch mit den Farben der modernen Architektur. Die Creative Colours sind ab Stückzahl 1 möglich. Im Katalog sind alle Serien mit einem Symbol gekennzeichnet.

With the charming **Creative Colours**, Molto Luce reflects the trend towards coloured accents in architecture. Based on forecasts published annually by the international trend institute WGSN (Worth Global Style Network), the colour palette is a curated, sustainable recommendation from actual professionals. Be it Berryblue, Merlot or Highlandgreen... our Creative Colours harmonise perfectly with our product range and simultaneously with the colours of modern architecture as well. Creative Colours are available from a quantity of 1. All series are labelled with a symbol in the catalogue.



Core Colours.

Die Farben Schwarz, Weiß und Grau bestimmen das Kernsortiment von Molto Luce.
The colours black, white and grey define the core range by Molto Luce.

-  WEISS / WHITE
-  GRAU / GREY
-  SCHWARZ / BLACK



Creative Colours.

Ob Beerenblau, Merlot oder Hochlandgrün...unsere Creative Colours harmonieren perfekt mit unserem Produktsortiment und gleichzeitig auch mit den Farben der modernen Architektur.

Be it Berryblue, Merlot or Highlandgreen...our Creative Colours harmonise perfectly with our product range and simultaneously with the colours of modern architecture as well.

-  CREME / CREME
-  TERRA / TERRA
-  BRONZE / BRONZE
-  GOLD / GOLD
-  KUPFER / COPPER
-  MERLOT / MERLOT
-  SEPIA / SEPIA
-  ANTHRAZIT / ANTHRACITE
-  BERLINERBLAU / BERLINBLUE
-  BEERENBLAU / BERRYBLUE
-  HOCHLANDGRÜN / HIGHLANDGREEN
-  TANNENGRÜN / FOREST



Aus produktionstechnischen Gründen sind nicht alle unsere Serien in Creative Colours umsetzbar. Mögliche Produkte sind im Katalog mit diesem Symbol gekennzeichnet. Creative Colours werden ab Stückzahl 1 gegen Aufpreis produziert.

Not all of our series can be implemented in Creative Colours for production technology reasons. Potential products are labelled with this symbol in the catalogue. Creative Colours are produced from a quantity of 1 for an additional charge.



Product: LITIN 2 SD, Info: page 490-491

QR-Code System

Klicken sie den QR-Code der Produkte und erhalten sie sämtliche benötigte Informationen wie z.B. Preise, Lagerstand, Datenblatt, Montageanleitungen, LTD Dateien, ULD-Dateien, 3-DS Dateien und Ausschreibungstexte auf ihrem PC.

Click the QR code of the products and get all the information you need, such as prices, stock levels, data sheets, mounting instructions, LTD files, ULD files, 3-DS files and tender texts on your PC.





ARCHITECTURAL



LIGHT IN SHAPE

Die aus Aluminium gefertigte Leuchtenserie BIDO besticht durch eine klare Formensprache. Eine runde sowie quadratische Version sind jeweils in 4 Größen erhältlich. Neben einer Einbauleuchte ist BIDO auch als Aufbau- und Hängeleuchte verfügbar, welche sowohl direkt als auch direkt/indirekt strahlend einsetzbar sind. BIDO ist ein stilvolles Element in der modernen Architektur und sowohl im gewerblichen Bereich als auch im privaten Wohnbereich vielfältig einsetzbar.

The pure form of the BIDO luminaire range made of aluminium is impressive. Also available in round and square, each in four different sizes. Aside from being a recessed luminaire, BIDO is also available as a surface-mounted or pendant luminaire, which can be used with a direct or indirect light output. BIDO is a stylish element in modern architecture and has a wide range of use in commercial spaces as well as living quarters.

Design: INHOUSE

BIDO



Gusswerk
Salzburg, Austria
Photo: Joachim Rauch



Hartkaiserbahn
Elmau, Austria
Photo: Joachim Rauch

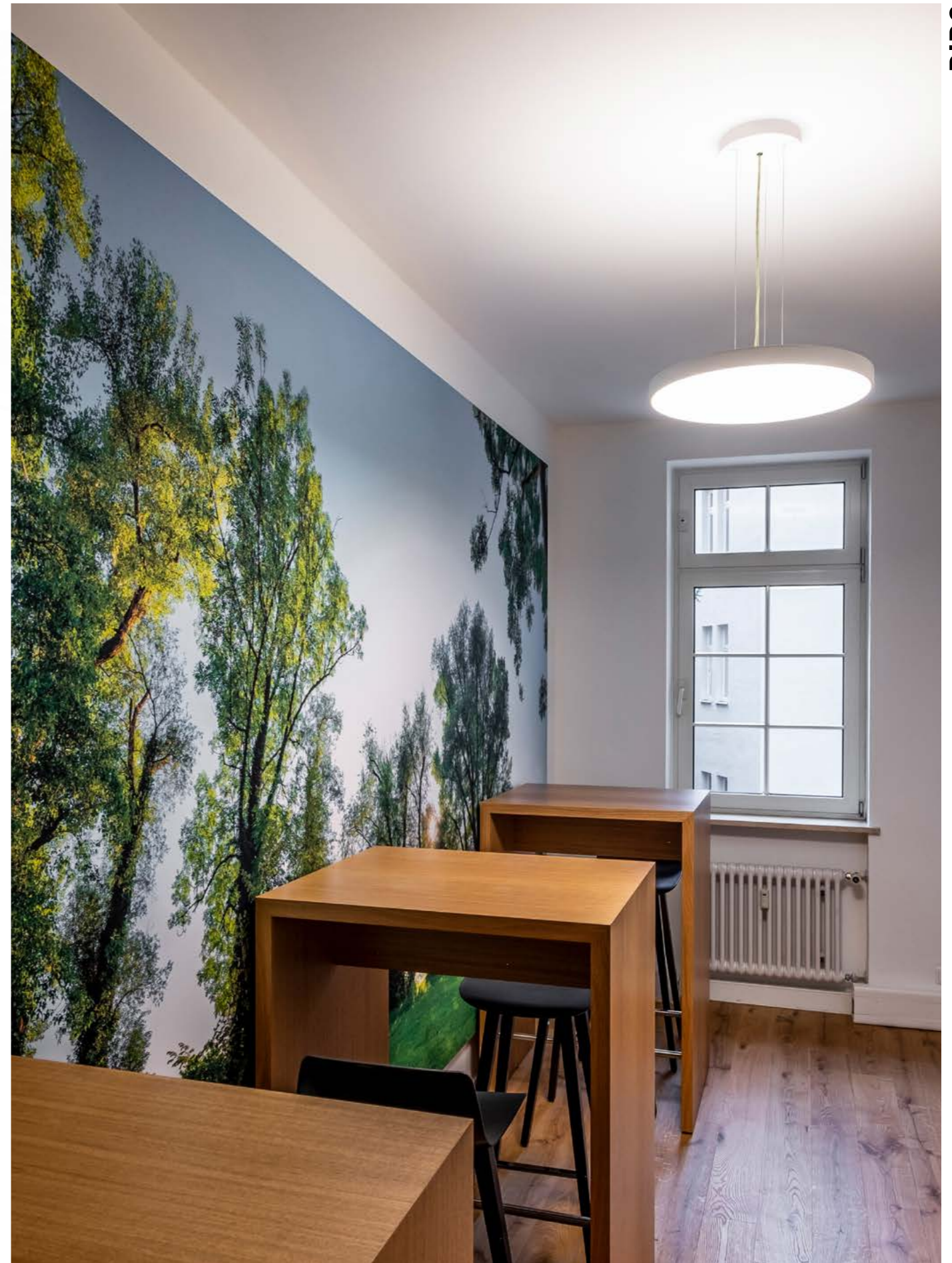

IDEAMED Zentrale
Munich, Germany
Photo: Alexander Schwarz



IBS Austria GmbH
Teufenbach, Austria
Photo: Joachim Rauch



Carpe Diem
Linz, Austria
Photo: Joachim Rauch

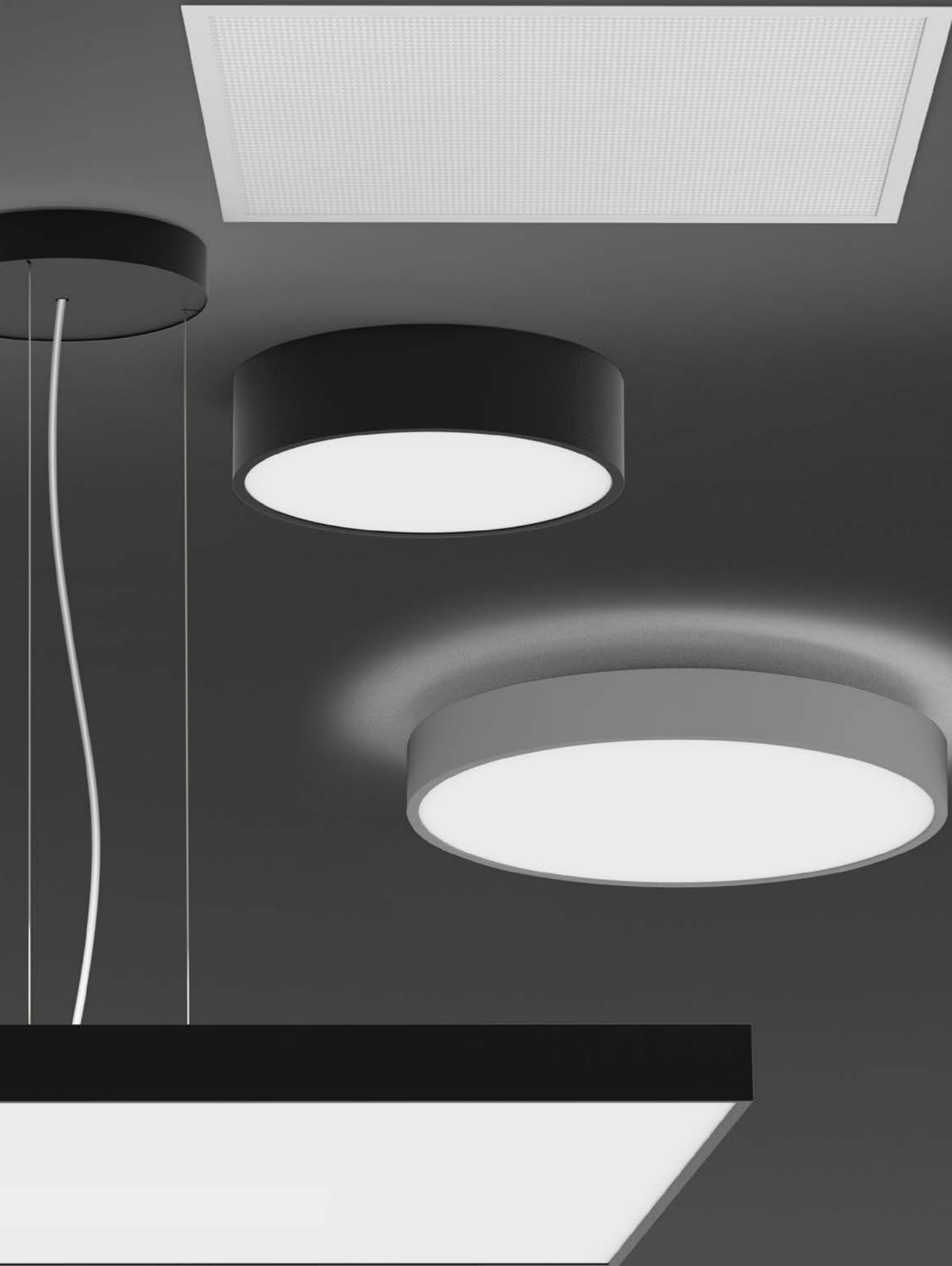

Versions

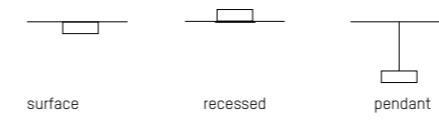

Form & Size

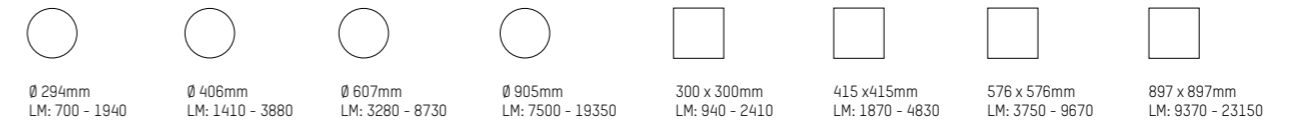

Core Colours

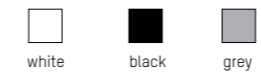

Creative Colours

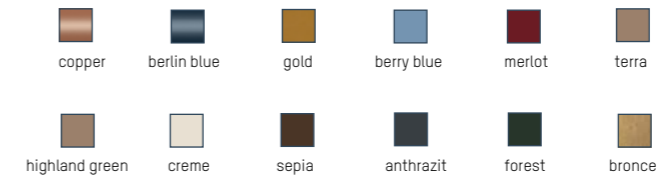

Cover

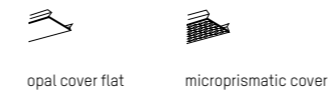

Light beam

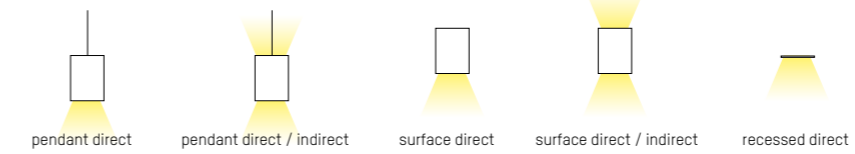

LED Colours



Specials

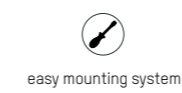

Design: INHOUSE

Configure BIDO





INNOVATIVE LIGHTING TECHNOLOGY, EXTRA-SLIM DESIGN

Modernste Edge-Lighting Technology durch speziell entwickelte Lichtleiterplatten vereint sich mit klarer Formensprache und schlankem Design zu einer variantenreichen Leuchtenfamilie. Die Produktfamilie ist als Baukastensystem konzipiert, sodass die Leuchten perfekt auf das Projekt abgestimmt werden können. Ein schräg nach innen verlaufender Dekorring vervollständigt das ansprechende Design. Die Vielfältigkeit schafft Abwechslung in der Raumgestaltung und ermöglicht ein spannendes Lichtkonzept innerhalb eines Projektes.

The latest Edge-Lighting technology with specially developed light guide plates creates a clear style and a slim-line design. The product family is designed as a modular system so that the luminaires can perfectly be tailored to the demands of a particular project. An obliquely inward decorative ring completes the particularly appealing design. The rich variety offers a huge degree of flexibility within a given space and provides scope for an exciting lighting concept within a project.

Design: INHOUSE

BINA



Tischlerei Berger
Ratten, Austria
Photo: Joachim Rauch

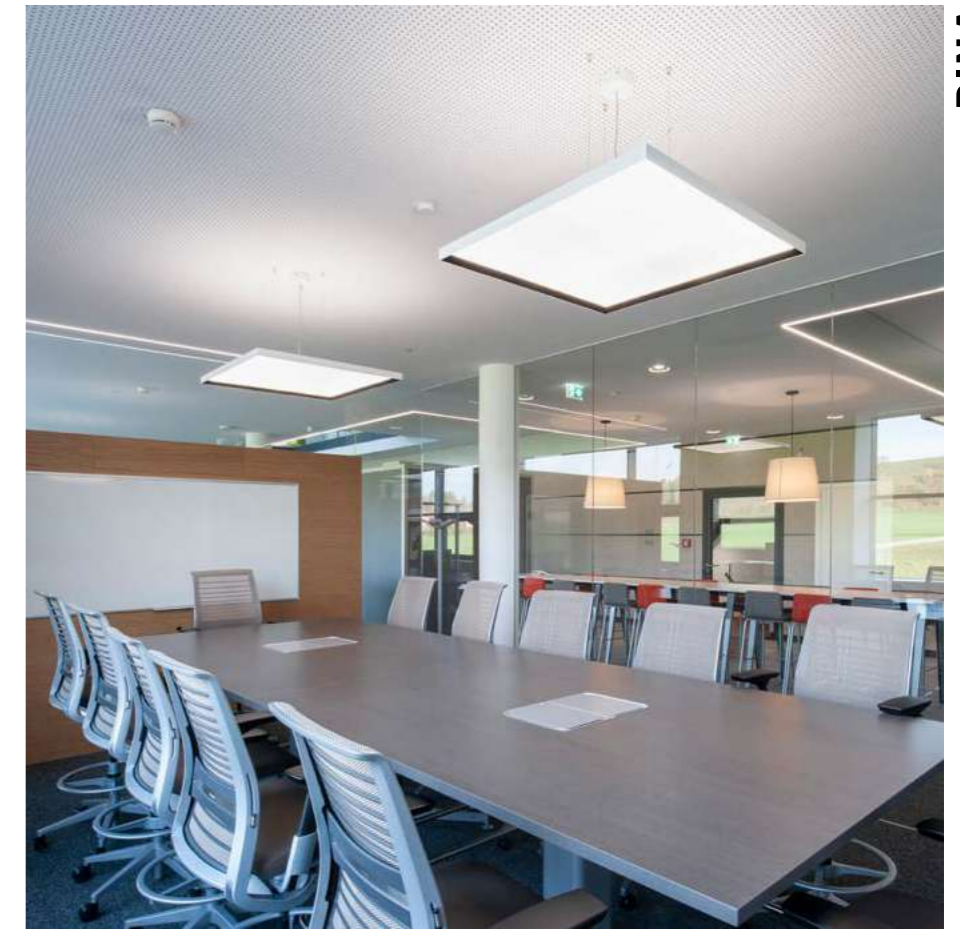

BMD Business Solutions
Steyr, Austria
Photo: Joachim Rauch



Raiffeisenbank Attersee-Süd
Nußdorf, Austria
Design + Architektur: AREA.at
Photo: Joachim Rauch



Accenture meetingroom
Vienna, Austria
Photo: Christian Brandstätter



IBS Austria GmbH
Teufenbach, Austria
Photo: Joachim Rauch

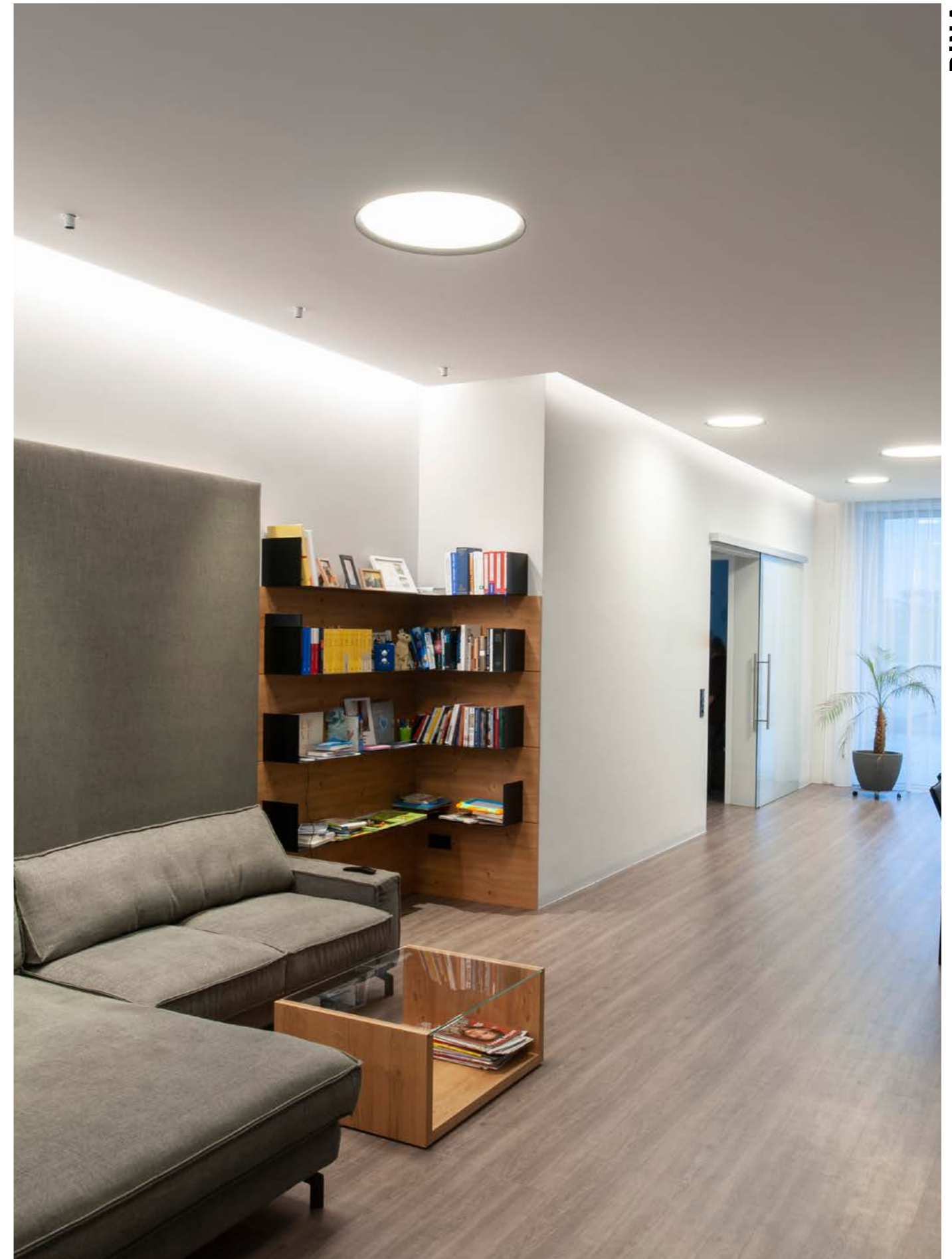

Private residence
Austria
Photo: Joachim Rauch



Versions



Form & Size

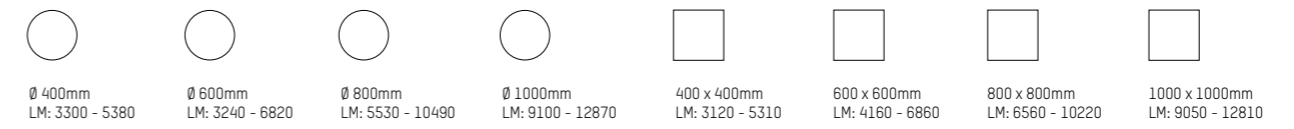

Core Colours

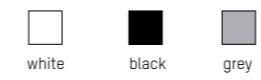

Creative Colours

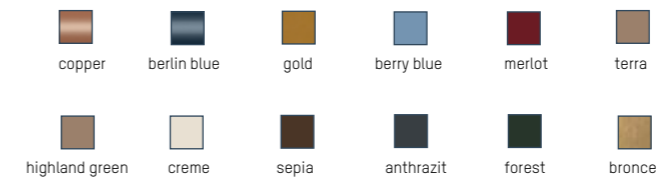

Cover

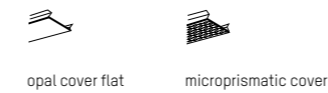

Light beam

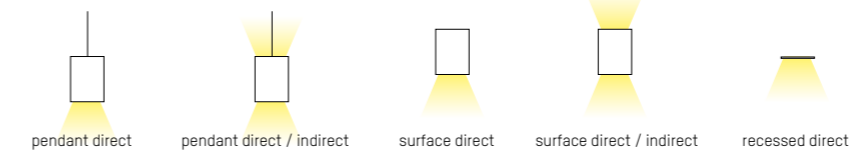

LED Colours



Specials



Design: INHOUSE

Configurate BINA





RINQ SD OPAL or MICROPRISMATIC DIFFUSER
 220-240V AC 50/60Hz

LED Aufbauleuchte aus Aluminiumprofil · Oberfläche pulverbeschichtet · Opale oder mikroprismatische Abdeckung · Schaltbar oder DALI dimmbar
 LED surface luminaire from aluminium profile · surface powder-coated · opal or microprismatic cover · switchable or DALI dimmable
 Lampada LED a plafone con profilo in alluminio · Superficie verniciata a polvere · Diffusore opale o microprismatico · On/off o dimmerabile DALI
 Plafonnier LED en profilé d'aluminium · Surface thermolaquée · Diffuseur opale ou à microprismes · On/off ou dimmable DALI

SYS 50W	Ø: 1200mm	LM	SYS 66W	Ø: 1500mm	LM
445-911201WCXYv1		4133 - 5320	445-911501WCXYv1		5507 - 7090
SYS 137W	Ø: 3000mm	LM	SYS 272W	Ø: 6000mm	LM
445-913001WCXYv1		10435 - 13340	445-916001WCXYv1		20860 - 26690

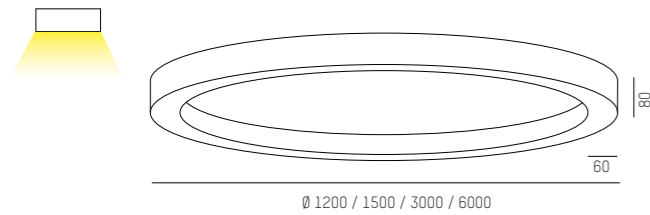

IP20

COMPLETE CODE			
W = LIGHT COLOUR	C = COVER	X = COLOUR	Y = DIMMABLE
LED 2700K = 3 CRI>80	opal = 1	champagne = 3	switchable = 0
LED 3000K = 9 CRI>80	microprismatic = 2 UGR<19	white = 5	DALI dimm. = d
LED 4000K = 4 CRI>80		black = 6	
		grey = 8	

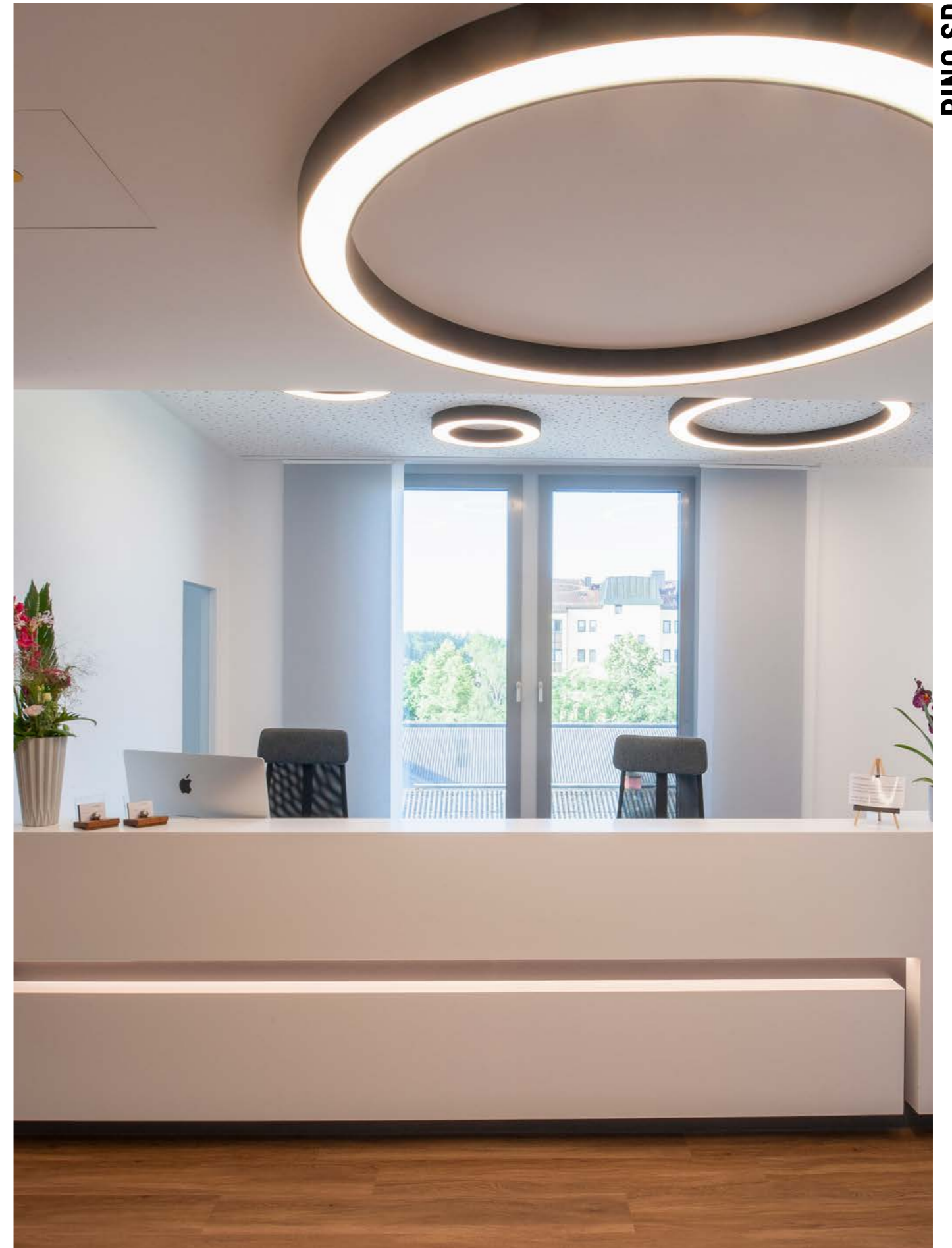

RINQ SD

Dentist Dr. Xyländer
 Munich, Germany
 Photo: Joachim Rauch

Technical data and energy efficiency



RINQ SD



RINQ PD OPAL or MICROPRISMATIC DIFFUSER
220-240V AC 50/60Hz

LED Pendelleuchte aus Aluminiumprofil · Oberfläche pulverbeschichtet · Opale oder mikroprismatische Abdeckung · Schaltbar oder DALI dimmbar
LED pendant from aluminium profile · surface powder-coated · opal or microprismatic cover · switchable or DALI dimmable
Lampada LED a sospensione con profilo in alluminio · Superficie verniciata a polvere · Diffusore opale o microprismatico · On/off o dimmerabile DALI
Suspension LED en profilé d'aluminium · Surface thermolaquée · Diffuseur opale ou à microprismes · On/off ou dimmable DALI

SYS 50W	Ø: 1200mm	LM	SYS 66W	Ø: 1500mm	LM
445-901201WXYv1		4133 - 5320	445-901501WXYv1		5507 - 7090

SYS 137W	Ø: 3000mm	LM	SYS 272W	Ø: 6000mm	LM
445-903001WXYv1		10435 - 13340	445-906001WXYv1		20860 - 26690

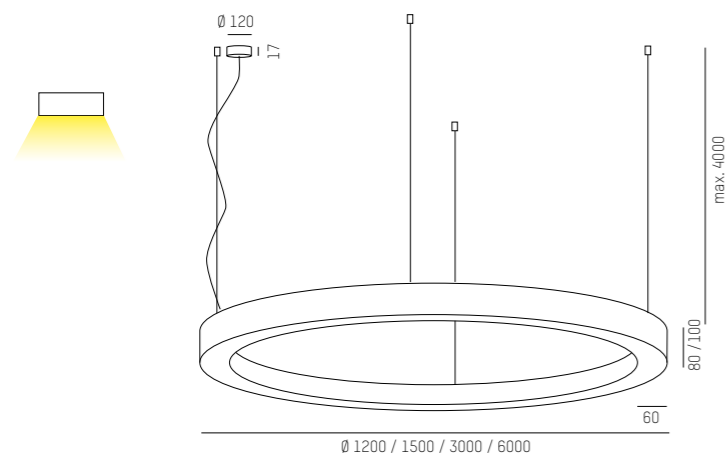

IP20

COMPLETE CODE			
W = LIGHT COLOUR	C = COVER	X = COLOUR	Y = DIMMABLE
W2 LED 2700K = 3 CRI>80	opal = 1	champagner = 3	switchable = 0
W3 LED 3000K = 9 CRI>80	microprismatic = 2 UGR<19	white = 5	DALI dimm. = d
W4 LED 4000K = 4 CRI>80		black = 6	
		grey = 8	



Blackhall St. Columbas's Church
Edinburgh, Scotland, UK
Photo: Keith Hunter

Technical data and energy efficiency





RINQ PDI OPAL or MICROPRISMATIC DIFFUSER
 220-240V AC 50/60Hz

LED Pendelleuchte aus Aluminiumprofil · Oberfläche pulverbeschichtet · Opale oder mikroprismatische Abdeckung · Schaltbar oder DALI dimmbar
 LED pendant from aluminium profile · surface powder-coated · opal or microprismatic cover · switchable or DALI dimmable
 Lampada LED a sospensione con profilo in alluminio · Superficie verniciata a polvere · Diffusore opale o microprismatico · On/off o dimmerabile DALI
 Suspension LED en profilé d'aluminium · Surface thermolaquée · Diffuseur opale ou à microprismes · On/off ou dimmable DALI

SYS 145W	Ø: 1200mm	LM	SYS 193W	Ø: 1500mm	LM
445-921201W	CXYv1	12838 - 14630	445-921501W	CXYv1	18569 - 21060
SYS 296W	Ø: 3000mm	LM	SYS 585W	Ø: 6000mm	LM
445-923001W	CXYv1	31594 - 35980	445-926001W	CXYv1	63197 - 71960

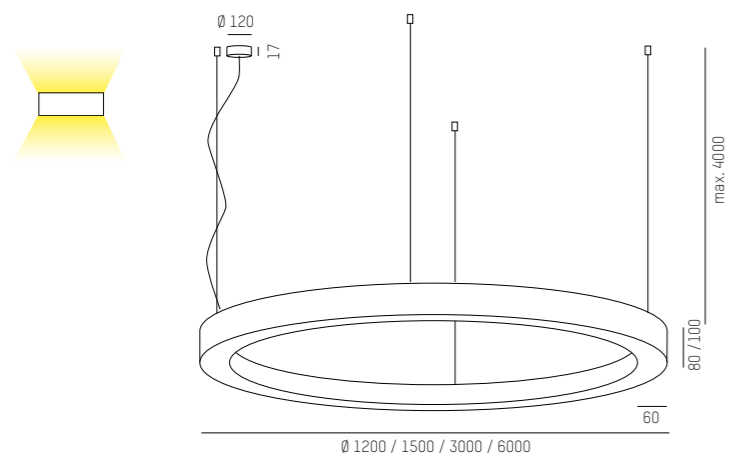

IP20 Ⓢ CE

COMPLETE CODE			
W = LIGHT COLOUR	C = COVER	X = COLOUR	Y = DIMMABLE
W2 LED 2700K = 3 CRI>80	opal = 1	CM champagner = 3	Ⓢ switchable = 0
W3 LED 3000K = 9 CRI>80	microprismatic = 2 UGR<19	W white = 5	Ⓞ DALI dimm. = d
W4 LED 4000K = 4 CRI>80		S black = 6	
		G grey = 8	



Technical data and energy efficiency





CHARM SD

220-240V AC 50/60Hz CRI>90

Design: Serge & Robert Cornelissen

Ringleuchte aus Aluminium · Oberfläche pulverbeschichtet · Konverter im Leuchtenprofil · dekor. Einschubfolien zur individuellen Gestaltung
 Ring luminaire in aluminium · surface powder-coated · built-in converter in profile · decoration slide-film for individual design
 Lampada a forma di anello in alluminio · superficie verniciata a polveri · Converter incluso nel profilo · Pellicola decorativa per customizzazione
 Luminaire en forme d'anneau, en aluminium · surface laquée en poudre · Convertisseur intégré dans le profil · film décoratif pour personnalisation

CHARM SD

SYS 91W	Ø 1006mm	LM
671-1010110	WWXXY	3690 - 6010



CHARM SD

SYS 137W	Ø 1506mm	LM
671-1020110	WWXXY	5530 - 9000



DEKORFOLIE FÜR CHARM 1000 DECOR FOIL FOR CHARM 1000

3 STÜCK ORDERN ORDER 3 PIECES	FARBE COLOUR	LM
671-430000000050	W	- 0%
671-430000000060	S	- 40%
671-430000000130	R	- 27%
671-430000000430	KU	- 25%

DEKORFOLIE FÜR CHARM 1500 DECOR FOIL FOR CHARM 1500

3 STÜCK ORDERN ORDER 3 PIECES	FARBE COLOUR	LM
671-431000000050	W	- 0%
671-431000000060	S	- 40%
671-431000000130	R	- 27%
671-431000000430	KU	- 25%

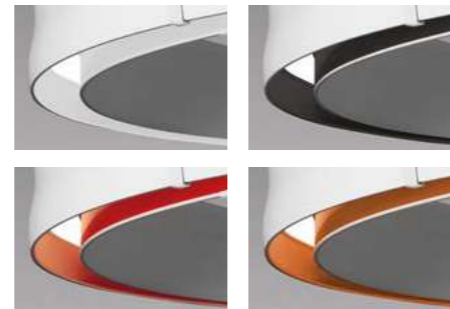
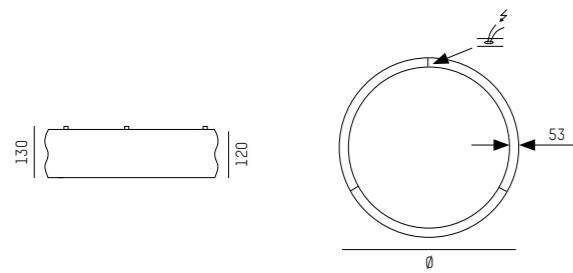

IP20 **reddot award 2018 winner**

COMPLETE CODE		
WW = LIGHT COLOUR	XX = COLOUR	Y = DIMMABLE
W2 LED 2700K = 23 CRI>90	W white = 05	S switchable = 0
W3 LED 3000K = 29 CRI>90	S black = 06	D DALI dimm. = d
W4 LED 4000K = 24 CRI>90		

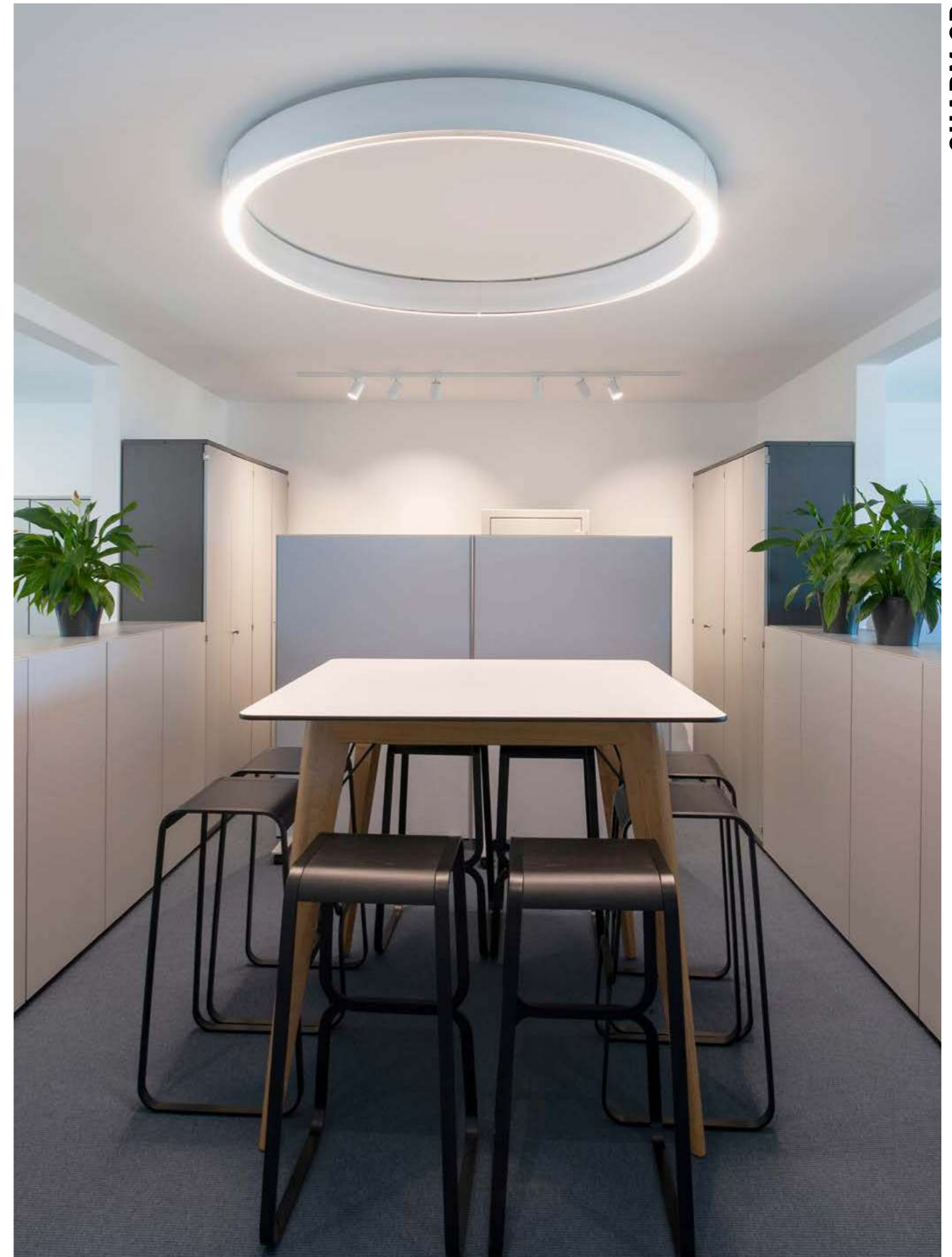

Technical data and energy efficiency

Molto Luce
Wels, Austria
Photo: Joachim Rauch





CHARM PD / PDI

220-240V AC 50/60Hz CRI>90

Design: Serge & Robert Cornelissen

Ringleuchte aus Aluminium · Oberfläche pulverbeschichtet · Konverter im Leuchtenprofil · dekor. Einschubfolien zur individuellen Gestaltung
 Ring luminaire in aluminium · surface powder-coated · built-in converter in profile · decoration slide-film for individual design
 Lampada a forma di anello in alluminio · superficie verniciata a polveri · Converter incluso nel profilo · Pellicola decorativa per customizzazione
 Suspension en forme d'anneau, en aluminium · surface laquée en poudre · Convertiseur intégré dans le profil · film décoratif pour personnalisation

CHARM PD

SYS 91W	Ø 1006mm	LM
671-2010110	WWXXY	3690 - 6010



CHARM PDI

SYS 151W	Ø 1006mm	LM
671-2010210	WWXXY	9550 - 12640



SYS 137W	Ø 1506mm	LM
671-2020110	WWXXY	5530 - 9000

SYS 235W	Ø 1506mm	LM
671-2020210	WWXXY	15040 - 19760

DEKORFOLIE FÜR CHARM 1000 DECOR FOIL FOR CHARM 1000

3 STÜCK ORDERN ORDER 3 PIECES	FARBE COLOUR	LM
671-430000000050	W	- 0%
671-430000000060	S	- 40%
671-430000000130	R	- 27%
671-430000000430	KU	- 25%

DEKORFOLIE FÜR CHARM 1500 DECOR FOIL FOR CHARM 1500

3 STÜCK ORDERN ORDER 3 PIECES	FARBE COLOUR	LM
671-431000000050	W	- 0%
671-431000000060	S	- 40%
671-431000000130	R	- 27%
671-431000000430	KU	- 25%

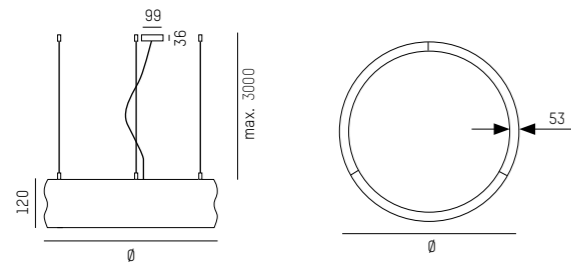
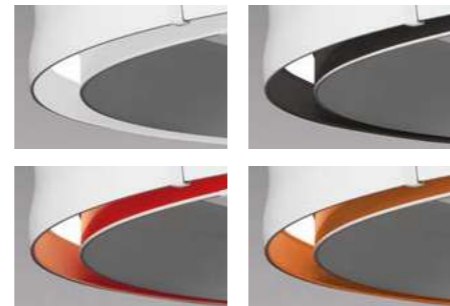

IP20 red dot award 2018 winner

COMPLETE CODE		
WW = LIGHT COLOUR	XX = COLOUR	Y = DIMMABLE
W2 LED 2700K = 23 CRI>90	W white = 05	S switchable = 0
W3 LED 3000K = 29 CRI>90	S black = 06	D DALI dimm. = d
W4 LED 4000K = 24 CRI>90		

040

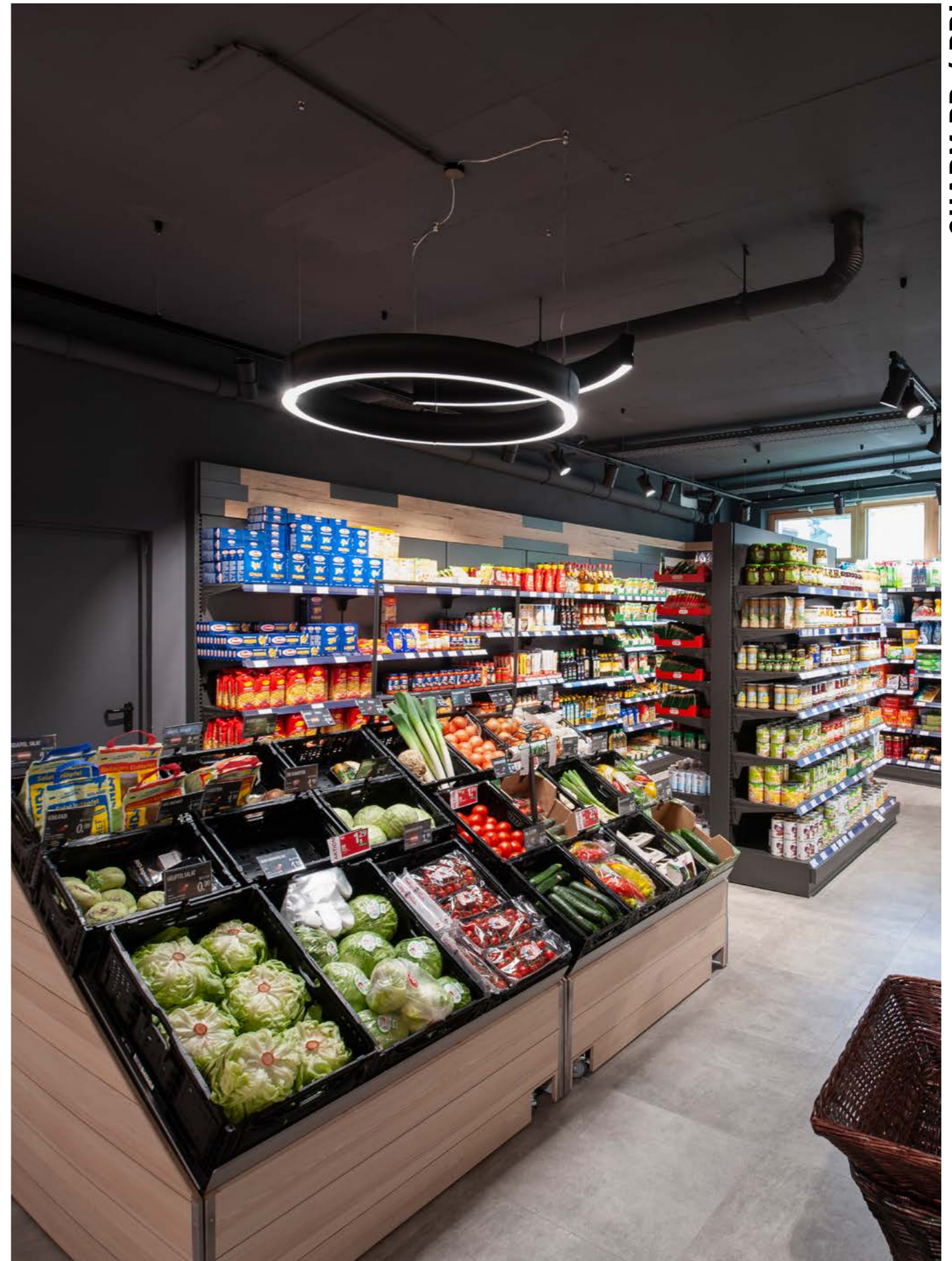

CHARM PD / PDI

ADEG
Dienten, Austria
Photo: Joachim Rauch

Technical data and energy efficiency



CHARM PD



CHARM PDI

041

BACK TO CONTENT

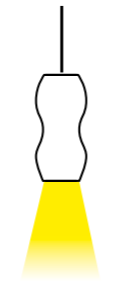

DIRECT BEAM

CHARM SYSTEM PD

220-240V AC 50/60Hz CRI>90

Design: Serge & Robert Cornelissen

Systemleuchte aus Aluminium · Oberfläche pulverbeschichtet · Converter im Leuchtenprofil · dekor. Einschubfolien zur individuellen Gestaltung
 System luminaire in aluminium · surface powder-coated · built-in converter in profile · decoration slide-film for individual design
 Lampada a sistema in alluminio · superficie verniciata a polveri · Converter incluso nel profilo · Pellicola decorativa per customizzazione
 Luminaire système en aluminium · surface laquée en poudre · Convertisseur intégré dans le profil · film décoratif pour personnalisation

CHARM 1000 SEGMENT PD

SYS 31W 120° LINKS / LEFT	LM
671-3030110WWXXY	1010 - 2000

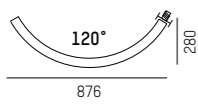

CHARM 1500 SEGMENT PD

SYS 46W 120° LINKS / LEFT	LM
671-3040110WWXXY	1840 - 3000

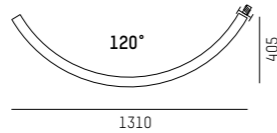

CHARM 1130 SEGMENT PD

SYS 33W GERADE / STRAIGHT	LM
671-3070110WWXXY	1330 - 2160

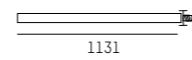

SYS 31W 120° RECHTS / RIGHT	LM
671-3050110WWXXY	1010 - 2000

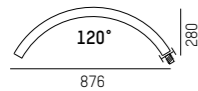

SYS 46W 120° RECHTS / RIGHT	LM
671-3060110WWXXY	1840 - 3000

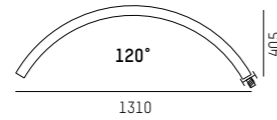

CHARM 2250 SEGMENT PD

SYS 66W GERADE / STRAIGHT	LM
671-3080110WWXXY	2660 - 4320

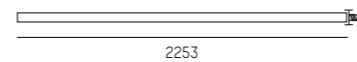

SYS 23W 90° LINKS / LEFT	LM
671-3090110WWXXY	920 - 1500

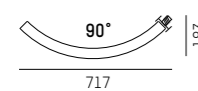

SYS 35W 90° LINKS / LEFT	LM
671-3100110WWXXY	1380 - 2250

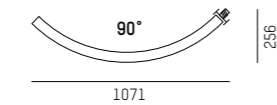

ENDECKELSET / END PIECE SET

671-440000000XX0
 inkl. Abhängung & 2 x Enddeckel
 incl. suspension & 2 x end piece



EINSPEISUNG / POWER FEED

671-450000000XX0 3 x 1,5mm²
 671-450000000XXd 5 x 1,5mm² DALI dimm.

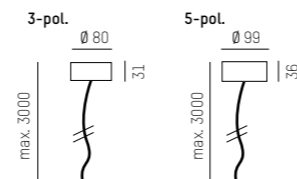

SYS 23W 90° RECHTS / RIGHT	LM
671-3110110WWXXY	920 - 1500

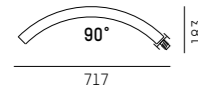

SYS 35W 90° RECHTS / RIGHT	LM
671-3120110WWXXY	1380 - 2250

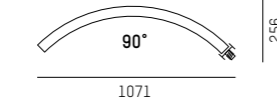

IP20 CE

COMPLETE CODE		
WW = LIGHT COLOUR	XX = COLOUR	Y = DIMMABLE
W2 LED 2700K = 23 CRI>90	W white = 05	S switchable = 0
W3 LED 3000K = 29 CRI>90	S black = 06	D DALI dimm. = d
W4 LED 4000K = 24 CRI>90		

DEKORFOLIE FÜR CHARM 1000 SEGMENT 120°
 DECOR FOIL FOR CHARM 1000 SEGMENT 120°

1 STÜCK ORDERN	FARBE	LM
ORDER 1 PIECE	COLOUR	LM
671-430000000050	W	- 0%
671-430000000060	S	- 40%
671-430000000130	R	- 27%
671-430000000430	KU	- 25%

DEKORFOLIE FÜR CHARM 1000 SEGMENT 90°
 DECOR FOIL FOR CHARM 1000 SEGMENT 90°

1 STÜCK ORDERN	FARBE	LM
ORDER 1 PIECE	COLOUR	LM
671-434000000050	W	- 0%
671-434000000060	S	- 40%
671-434000000130	R	- 27%
671-434000000430	KU	- 25%

DEKORFOLIE FÜR CHARM 1500 SEGMENT 120°
 DECOR FOIL FOR CHARM 1500 SEGMENT 120°

1 STÜCK ORDERN	FARBE	LM
ORDER 1 PIECE	COLOUR	LM
671-431000000050	W	- 0%
671-431000000060	S	- 40%
671-431000000130	R	- 27%
671-431000000430	KU	- 25%

DEKORFOLIE FÜR CHARM 1500 SEGMENT 90°
 DECOR FOIL FOR CHARM 1500 SEGMENT 90°

1 STÜCK ORDERN	FARBE	LM
ORDER 1 PIECE	COLOUR	LM
671-435000000050	W	- 0%
671-435000000060	S	- 40%
671-435000000130	R	- 27%
671-435000000430	KU	- 25%

DEKORFOLIE FÜR CHARM 1130 SEGMENT GERADE
 DECOR FOIL FOR CHARM 1130 SEGMENT STRAIGHT

1 STÜCK ORDERN	FARBE	LM
ORDER 1 PIECE	COLOUR	LM
671-432000000050	W	- 0%
671-432000000060	S	- 40%
671-432000000130	R	- 27%
671-432000000430	KU	- 25%

DEKORFOLIE FÜR CHARM 2250 SEGMENT GERADE
 DECOR FOIL FOR CHARM 2250 SEGMENT STRAIGHT

1 STÜCK ORDERN	FARBE	LM
ORDER 1 PIECE	COLOUR	LM
671-433000000050	W	- 0%
671-433000000060	S	- 40%
671-433000000130	R	- 27%
671-433000000430	KU	- 25%

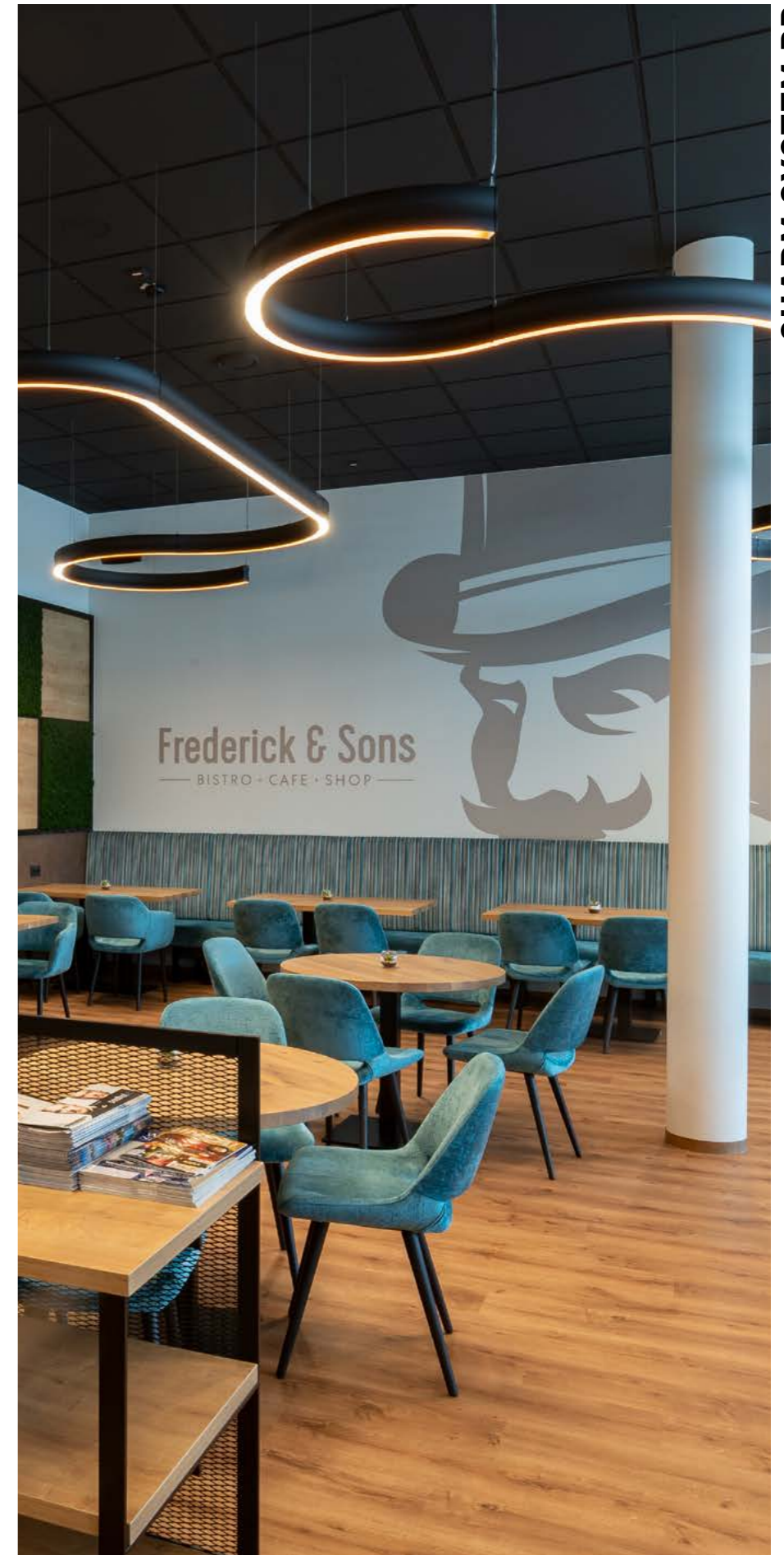
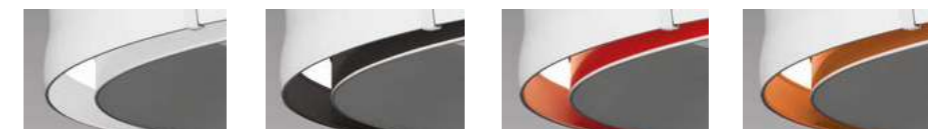

CHARM SYSTEM PD

Technical data and energy efficiency

Frederick & Sons
 Linz Airport, Austria
 Photo: Joachim Rauch



CHARM SYSTEM PD

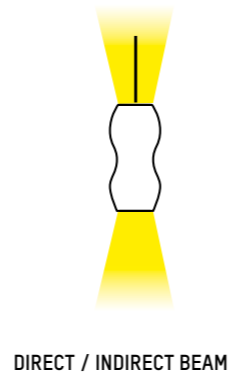

CHARM SYSTEM PDI

220-240V AC 50/60Hz CRI>90

Design: Serge & Robert Cornelissen

Systemleuchte aus Aluminium · Oberfläche pulverbeschichtet · Converter im Leuchtenprofil · dekor. Einschubfolien zur individuellen Gestaltung
 System luminaire in aluminium · surface powder-coated · built-in converter in profile · decoration slide-film for individual design
 Lampada a sistema in alluminio · superficie verniciata a polveri · Converter incluso nel profilo · Pellicola decorativa per customizzazione
 Luminaire système en aluminium · surface laquée en poudre · Convertisseur intégré dans le profil · film décoratif pour personnalisation

CHARM 1000 SEGMENT PDI

SYS 51W 120° LINKS / LEFT	LM
671-3030210WWXXY	3180 - 4210

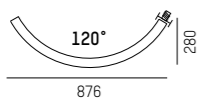

CHARM 1500 SEGMENT PDI

SYS 79W 120° LINKS / LEFT	LM
671-3040210WWXXY	5010 - 6580

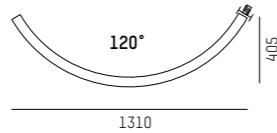

CHARM 1130 SEGMENT PDI

SYS 56W GERADE / STRAIGHT	LM
671-3070210WWXXY	3520 - 4650

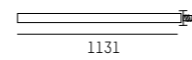

SYS 51W 120° RECHTS / RIGHT	LM
671-3050210WWXXY	3180 - 4210

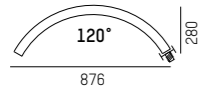

SYS 79W 120° RECHTS / RIGHT	LM
671-3060210WWXXY	5010 - 6580

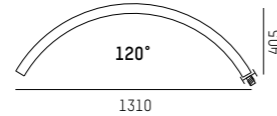

CHARM 2250 SEGMENT PD

SYS 111W GERADE / STRAIGHT	LM
671-3080210WWXXY	7040 - 9300

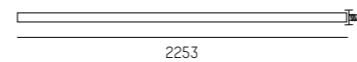

SYS 38W 90° LINKS / LEFT	LM
671-3090210WWXXY	2380 - 3160

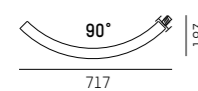

SYS 59W 90° LINKS / LEFT	LM
671-3100210WWXXY	3760 - 4940

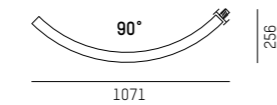

ENDECKELSET / END PIECE SET

671-440000000XX0
 inkl. Abhängung & 2 x Enddeckel
 incl. suspension & 2 x end piece



EINSPEISUNG / POWER FEED

671-450000000XX0 3 x 1,5mm²
 671-450000000XXd 5 x 1,5mm² DALI dimm.

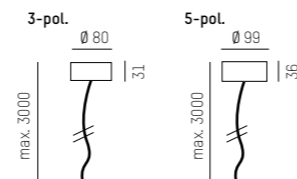

SYS 38W 90° RECHTS / RIGHT	LM
671-3110210WWXXY	2380 - 3160

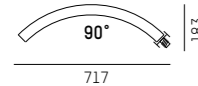

SYS 59W 90° RECHTS / RIGHT	LM
671-3120210WWXXY	3760 - 4940

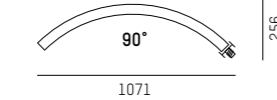

IP20 CE

COMPLETE CODE		
WW = LIGHT COLOUR	XX = COLOUR	Y = DIMMABLE
W2 LED 2700K = 23 CRI>90	W white = 05	S switchable = 0
W3 LED 3000K = 29 CRI>90	S black = 06	D DALI dimm. = d
W4 LED 4000K = 24 CRI>90		

DEKORFOLIE FÜR CHARM 1000 SEGMENT 120° DECOR FOIL FOR CHARM 1000 SEGMENT 120°

1 STÜCK ORDERN ORDER 1 PIECE	FARBE COLOUR	LM
671-430000000050	W	- 0%
671-430000000060	S	- 40%
671-430000000130	R	- 27%
671-430000000430	KU	- 25%

DEKORFOLIE FÜR CHARM 1000 SEGMENT 90° DECOR FOIL FOR CHARM 1000 SEGMENT 90°

1 STÜCK ORDERN ORDER 1 PIECE	FARBE COLOUR	LM
671-434000000050	W	- 0%
671-434000000060	S	- 40%
671-434000000130	R	- 27%
671-434000000430	KU	- 25%

DEKORFOLIE FÜR CHARM 1500 SEGMENT 120° DECOR FOIL FOR CHARM 1500 SEGMENT 120°

1 STÜCK ORDERN ORDER 1 PIECE	FARBE COLOUR	LM
671-431000000050	W	- 0%
671-431000000060	S	- 40%
671-431000000130	R	- 27%
671-431000000430	KU	- 25%

DEKORFOLIE FÜR CHARM 1500 SEGMENT 90° DECOR FOIL FOR CHARM 1500 SEGMENT 90°

1 STÜCK ORDERN ORDER 1 PIECE	FARBE COLOUR	LM
671-435000000050	W	- 0%
671-435000000060	S	- 40%
671-435000000130	R	- 27%
671-435000000430	KU	- 25%

DEKORFOLIE FÜR CHARM 1130 SEGMENT GERADE DECOR FOIL FOR CHARM 1130 SEGMENT STRAIGHT

1 STÜCK ORDERN ORDER 1 PIECE	FARBE COLOUR	LM
671-432000000050	W	- 0%
671-432000000060	S	- 40%
671-432000000130	R	- 27%
671-432000000430	KU	- 25%

DEKORFOLIE FÜR CHARM 2250 SEGMENT GERADE DECOR FOIL FOR CHARM 2250 SEGMENT STRAIGHT

1 STÜCK ORDERN ORDER 1 PIECE	FARBE COLOUR	LM
671-433000000050	W	- 0%
671-433000000060	S	- 40%
671-433000000130	R	- 27%
671-433000000430	KU	- 25%

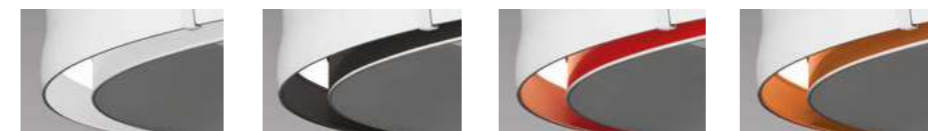

CHARM SYSTEM PDI

Technical data and energy efficiency

EDIS Barbershop
 Murten, Switzerland
 Photo: fotobility.ch



CHARM SYSTEM PDI



MAXIMUM FLEXIBILITY – MINIMALIST DESIGN

Versetzen oder einfach nur den Strahlerkopf verstellen, die einfache Magnetbefestigung ermöglicht ein schnelles Umgestalten der Komponenten. Zudem sind alle Lichteinsätze verpolungssicher und können bequem auch beidseitig in die Schiene eingesetzt werden. Diverse Lichteinsätze in unterschiedlichen Längen, sowie die Strahler in drei Größen, bieten eine absolut flächenbündig in der Schiene sitzende lineare Grundbeleuchtung mit Akzentuierung. Nur ein Handgriff und jedes beliebige Objekt ist perfekt in Szene gesetzt.

Move or simply adjust the spotlight head, the simple magnetic fixture ensures fast rearrangement of the components. On top of that, all luminaire inputs are protected against wrong polarity and can be easily inserted on both sides of the rail. Various light inserts of different lengths as well as spotlights in three sizes offer a linear basic lighting which is absolutely flush with the rail and sets accents. Draw attention to any object with a flick of the wrist.

Design: INHOUSE

MAGNETICS



Versions

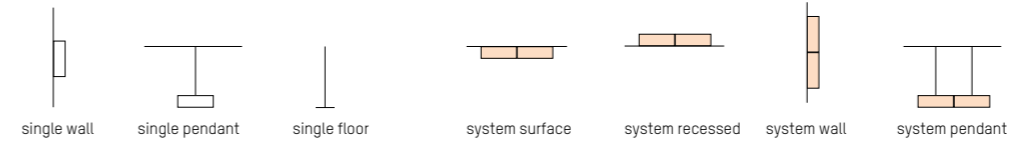

U-Profile



surface / recessed
16,5 x 12,6mm

H-Profile



wall / pendant / stand
16,5 x 35mm

Form



linear

Core Colour



black

System inserts



Light beam



LED Colours



Design: INHOUSE

Information MAGNETICS





Jewellery Bisaku
Brno, Czech Republic
Photo: Michal Zvonar

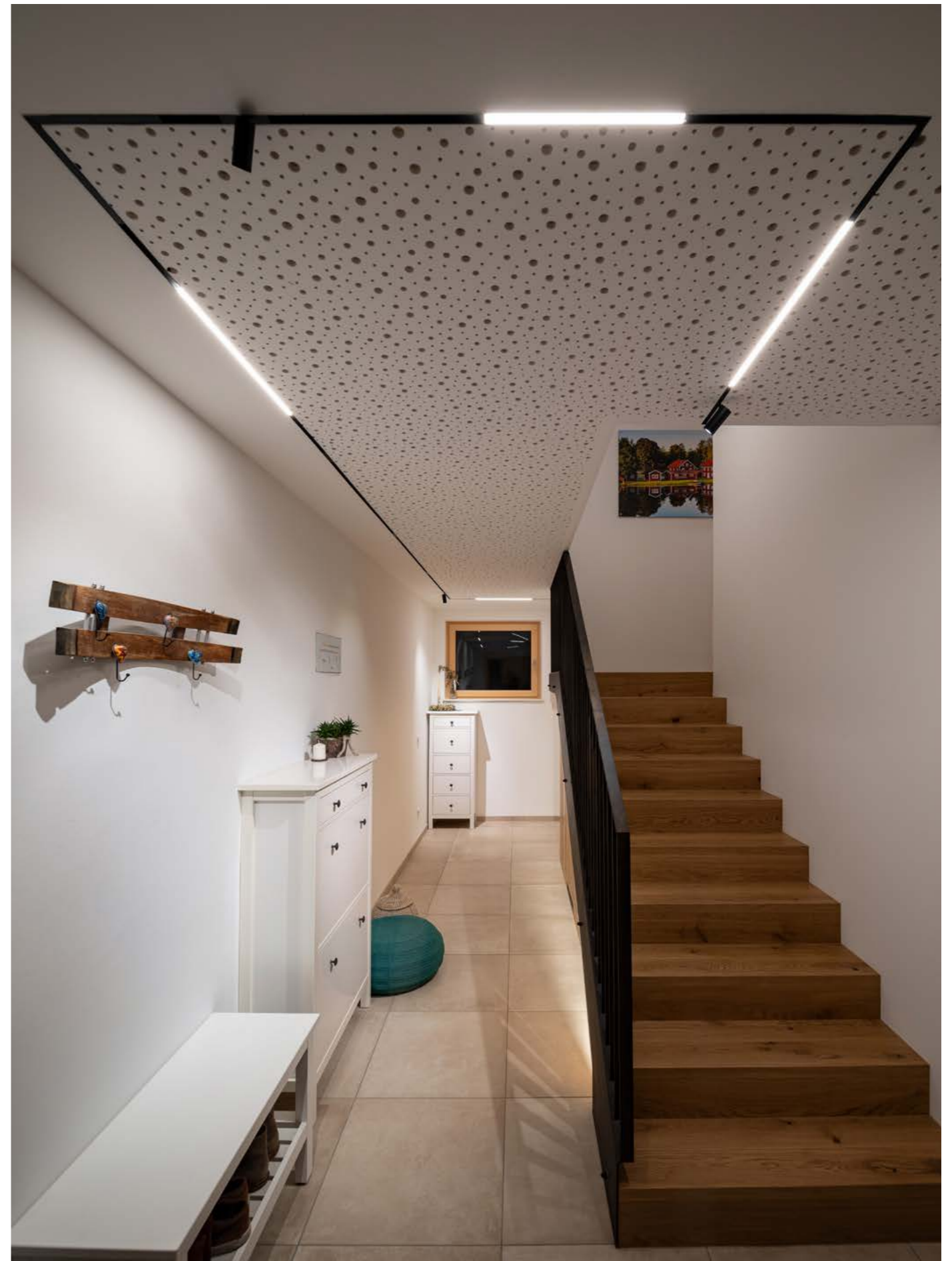

Betten Reiter
Vienna, Austria
Photo: Joachim Rauch



Private Residence
Austria
Photo: Joachim Rauch



Private Residence
Austria
Photo: Joachim Rauch



Intersport Tscherne
Salzburg, Austria
Photo: Joachim Rauch

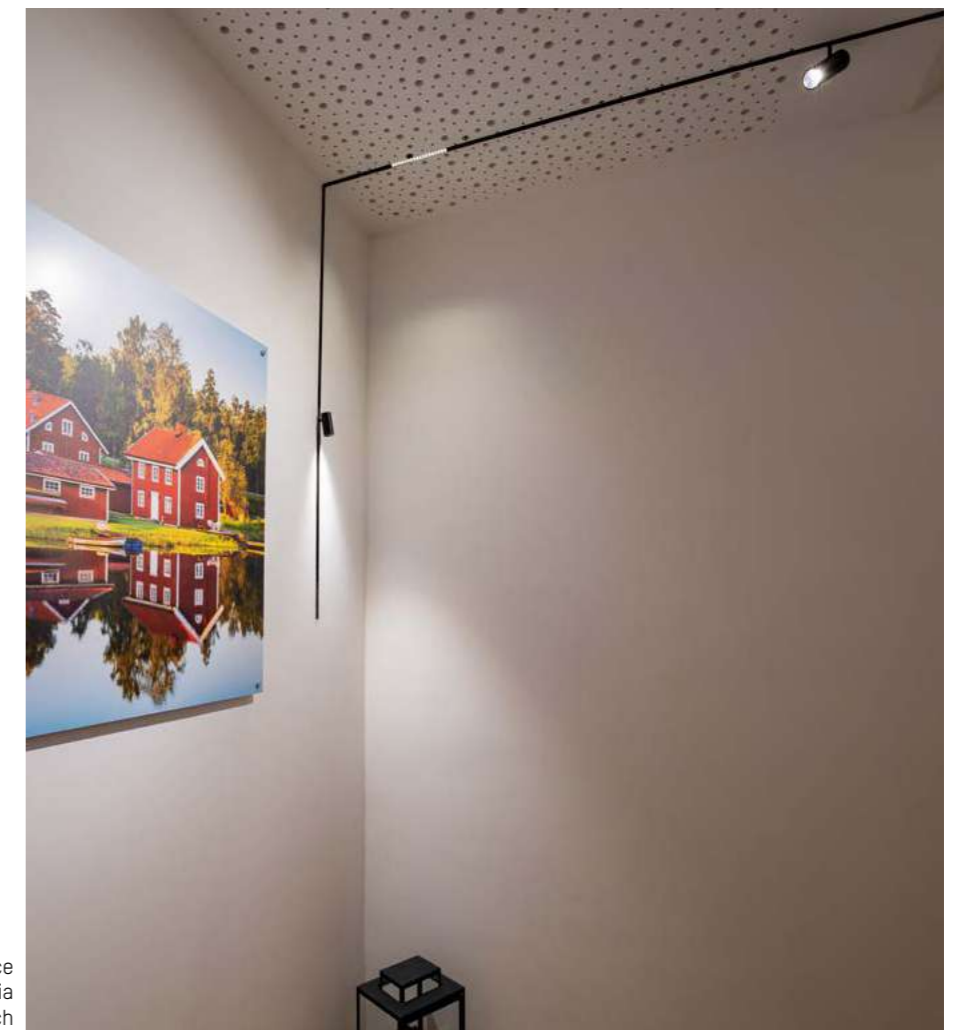

Private Residence
Austria
Photo: Joachim Rauch



TRACK COMPONENTS

24V DC

Design: INHOUSE

24V Stromschiene aus Aluminiumprofil · 4-Polig · Oberfläche schwarz · Installation als Aufbau- und Einbaumontage · Systemzubehör separat ordern
 24V electrified track made of aluminium profile · 4-pole · black surface · installation as surface- and recessed · order system accessories separately
 Binario elettrificato 24V · 4 poli · in alluminio · finitura nera · montaggio a plafone o incasso · accessori da ordinare separatamente
 Rail électrifié en aluminium 24V · 4 pôles · finition noire · montage en surface ou encastré · accessoires à commander séparément

MAGNETICS PROFIL MAGNETICS PROFILE	LÄNGE LENGHT	FARBE COLOUR
708-00101000006d	300mm	black
708-00102000006d	600mm	black
708-00103000006d	900mm	black
708-00104000006d	1200mm	black
708-00105000006d	1500mm	black
708-00106000006d	1800mm	black
708-00107000006d	2100mm	black
708-00108000006d	2400mm	black

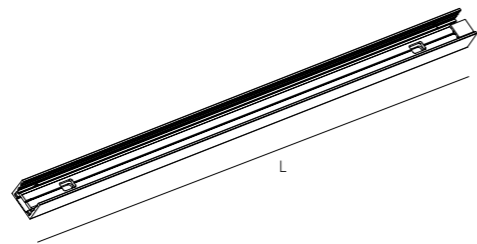
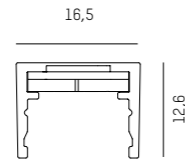

ENDSTÜCK END PIECE	FARBE COLOUR
708-006010000060	black

EINBAUMONTAGESSET RECESSED MOUNTING SET
708-0000200

IP20 CE

JUNCTION

90° VERBINDER 90° JUNCTION	FARBE COLOUR
708-00501000006d	black

inkl. 1 Stk. Platinenverbinder
incl. 1 pce. board junction

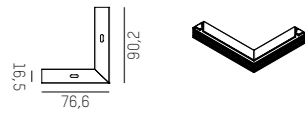

90° WAND / DECKENVERBINDER 90° WALL/CEILING JUNCTION	FARBE COLOUR
708-00502000006d	black

inkl. 1 Stk. Platinenverbinder
incl. 1 pce. board junction

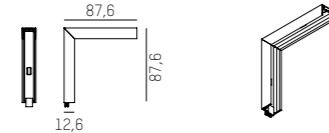

T VERBINDER T JUNCTION	FARBE COLOUR
708-00504000006d	black

inkl. 2 Stk. Platinenverbinder
incl. 2 pce. board junction



X VERBINDER X JUNCTION	FARBE COLOUR
708-00505000006d	black

inkl. 3 Stk. Platinenverbinder
incl. 3 pce. board junction

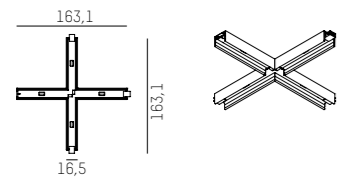

PLATINENVERBINDUNGSSET BOARD JUNCTION SET	FARBE COLOUR
708-00001000006d	black

5 Stk. (Ersatzteil)
5 pcs. (spare part)



FLEXVERBINDER FLEXIBLE JUNCTION	FARBE COLOUR
708-00503000006d	black

inkl. 1 Stk. Platinenverbinder
muss vor Ort geschnitten werden
incl. 1 pce. board junction
must be cut on site

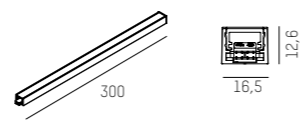

POWER FEED

Alle Einspeisungen für ON/Off und Dali Nutzbar, je nach Modell inkl. oder exkl. DALI Repeater, Anschlussmöglichkeit für DALI ist bei allen Modellen möglich.
 ACHTUNG: Kein Push-Dimm-Betrieb möglich
 All feeds for ON/Off and Dali Usable, depending on the model incl. or excl. DALI repeater, connection option for DALI is possible with all models.
 ATTENTION: No push dimming operation possible

DALI REPEATER FÜR GALVANISCHE TRENNUNG DALI REPEATER FOR GALVANIC SEPERATION	LEISTUNG POWER
---	-------------------

711-sr2400amp
 max. 64 DALI Adressen
 max. 64 DALI addresses

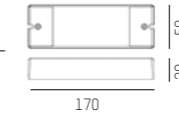

AUFBAUEINSPEISUNG MITTE / ENDE SURFACE CENTER / END POWER FEED	FARBE COLOUR
---	-----------------

708-00401000006d
 inkl. Endstück, exkl. LED Konverter
 incl. end piece, excl. LED driver

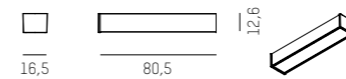

EINBAUEINSPEISUNG MITTE / ENDE RECESSED CENTER / END POWER FEED	FARBE COLOUR
--	-----------------

708-00405000006d
 inkl. Endstück, exkl. LED Konverter
 incl. end piece, excl. LED driver

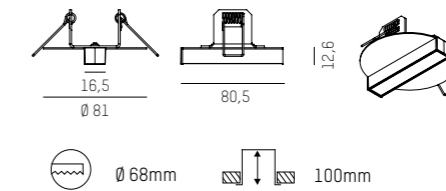

LED KONVERTER MAGNETICS LED DRIVER MAGNETICS	LEISTUNG POWER
---	-------------------

24-127824
 schaltbar
 switchable

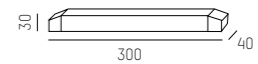

BALDACHIN DALI CEILING BASE DALI	LEISTUNG POWER	FARBE COLOUR
-------------------------------------	-------------------	-----------------

708-00403000006d
 Inkl. LED Konverter / incl. LED driver

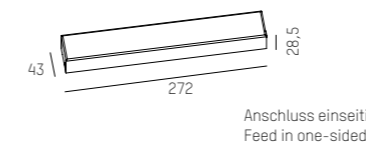

Anschluss einseitig
Feed in one-sided

BALDACHIN DALI CEILING BASE DALI	LEISTUNG POWER	FARBE COLOUR
-------------------------------------	-------------------	-----------------

708-00404000006d
 Inkl. LED Konverter / incl. LED driver

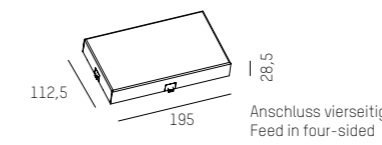

Anschluss vierseitig
Feed in four-sided

BALDACHIN DALI CEILING BASE DALI	LEISTUNG POWER	FARBE COLOUR
-------------------------------------	-------------------	-----------------

708-00406000006d
 max. 100W
 black
 inkl. LED Konverter
 inkl. DALI Repeater für galvanische Trennung
 incl. LED driver
 incl. DALI repeater for galvanic separation

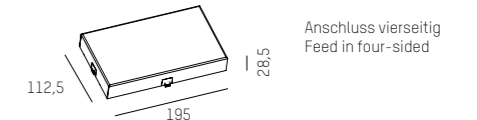

Anschluss vierseitig
Feed in four-sided

ANSCHLUSSSCHEMA / EXAMPLE OF CONNECTION

schaltbar
switchable

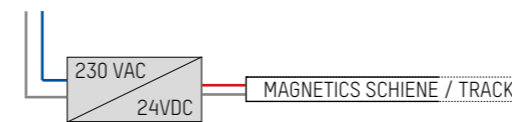

DALI dimmbar
DALI dimmable

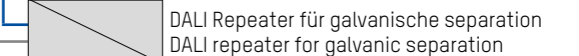
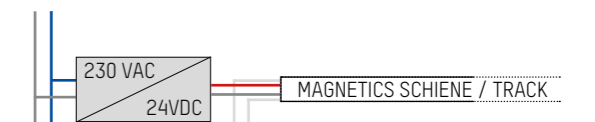

DALI Eingang
DALI input





TRACK COMPONENTS PENDANT

24V DC

Design: INHOUSE

24V Stromschiene aus Aluminiumprofil · 4-polig · Oberfläche schwarz · Installation als Pendelmontage · Systemzubehör & Lichteinsätze separat ordern
 24V electrified track made of aluminium profile · 4-pole · black surface · suspension mounting · order system accessories separately
 Binario elettrificato 24V · 4 poli · in alluminio · finitura nera · montaggio a sospensione · accessori ed inserti luminosi da ordinare separatamente
 Rail électrifié en aluminium 24V · 4 pôles · finition noire · montage en suspension · accessoires et inserts lumineux à commander séparément

MAGNETICS H PROFIL MAGNETICS H PROFILE	LÄNGE LENGHT	FARBE COLOUR
708-00701000006d	300mm	black
708-00702000006d	600mm	black
708-00703000006d	900mm	black
708-00704000006d	1200mm	black
708-00705000006d	1500mm	black
708-00706000006d	1800mm	black
708-00707000006d	2100mm	black
708-00708000006d	2400mm	black

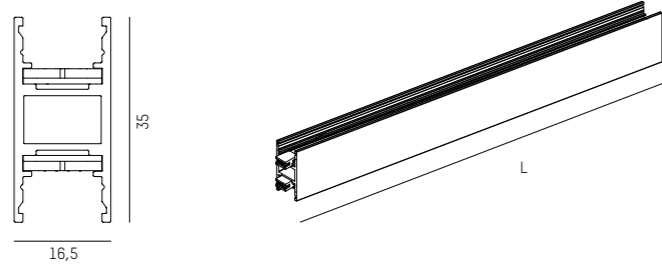

ENDSTÜCK END PIECE	FARBE COLOUR
708-006020000060	black

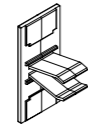

IP20 CE

JUNCTION

LINEARVERBINDER LINEAR JUNCTION	FARBE COLOUR
708-005060000060	aluminium

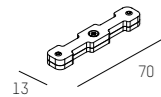

90° VERBINDER 90° JUNCTION	FARBE COLOUR
708-00507000006d	black

inkl. 2 Stk. Platinenverbinder
incl. 2 pce. board junction

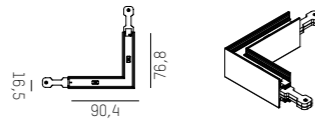

T VERBINDER T JUNCTION	FARBE COLOUR
708-00508000006d	black

inkl. 4 Stk. Platinenverbinder
incl. 4 pce. board junction

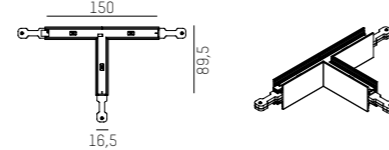

X VERBINDER X JUNCTION	FARBE COLOUR
708-00509000006d	black

inkl. 6 Stk. Platinenverbinder
incl. 6 pce. board junction

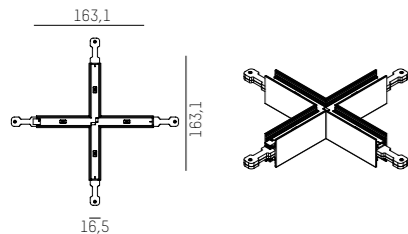

KABELABHÄNGUNG CABLE SUSPENSION	FARBE COLOUR
708-008010000060	nichel

L: max. 1500mm

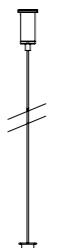

Max. Abstand: 1,5m
Max. distance: 1,5m

PLATINENVERBINDUNGSSET BOARD JUNCTION SET	FARBE COLOUR
708-00001000006d	black

5 Stk. (Ersatzteil)
5 pcs. (spare part)



POWER FEED

Alle Einspeisungen für ON/Off und Dali nutzbar, je nach Modell inkl. oder exkl. DALI Repeater, Anschlussmöglichkeit für DALI ist bei allen Modellen möglich.
 ACHTUNG: Kein Push-Dimm-Betrieb möglich

All feeds for ON/Off and Dali usable, depending on the model incl. or excl. DALI repeater, connection option for DALI is possible with all models.
 ATTENTION: No push dimming operation possible

DALI REPEATER FÜR GALVANISCHE TRENNUNG DALI REPEATER FOR GALVANIC SEPERATION	LEISTUNG POWER
---	-------------------

711-sr2400amp
 max. 64 DALI Adressen
 max. 64 DALI addresses

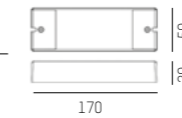

PENDELEINSPEISUNG MITTE / ENDE PENDANT CENTER / END POWER FEED	LEISTUNG POWER	FARBE COLOUR
---	-------------------	-----------------

708-00408000006d
 2 x max. 100W
 black
 Baldachin inkl. LED Konverter, inkl. Verbinder und Enddeckel
 Ceiling base incl. LED driver, incl. connector and end piece

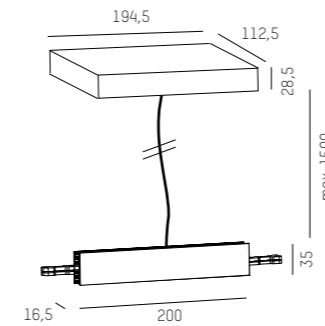

PENDELEINSPEISUNG MITTE / ENDE PENDANT CENTER / END POWER FEED	LEISTUNG POWER	FARBE COLOUR
---	-------------------	-----------------

708-00409000006d
 max. 100W
 black
 Baldachin inkl. LED Konverter, inkl. Verbinder und Enddeckel
 Inkl. DALI Repeater für galvanische Trennung
 Ceiling base incl. LED driver, incl. connector and end piece
 incl. DALI repeater for galvanic separation

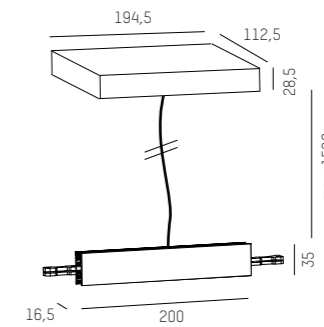

ANSCHLUSSSCHEMA / EXAMPLE OF CONNECTION

schaltbar
switchable

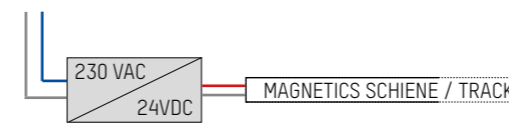

DALI dimmbar
DALI dimmable

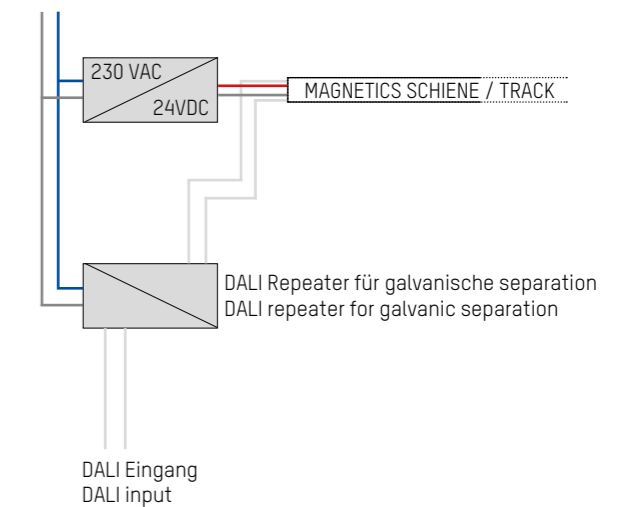



TRACK COMPONENTS WALL

24V DC

Design: INHOUSE

24V Dali Stromschiene aus Aluminiumprofil 4-polig · Oberfläche schwarz · Installation als Wandmontage · Systemzubehör & Lichteinsätze separat ordern
 24V dali electrified track made of aluminium profile · 4-pole · black surface · wall mounting · order system accessories separately
 Binario dali elettrificato 24V · 4 poli · in alluminio · finitura nera · montaggio a parete · accessori & inserti luminosi da ordinare separatamente
 Rail dali électrifié en aluminium 24V · 4 pôles · finition noire · montage mural · accessoires & inserts lumineux à commander séparément

MAGNETICS H PROFIL MAGNETICS H PROFILE	LÄNGE LENGHT	FARBE COLOUR
708-01101000006d	300mm	black
708-01102000006d	600mm	black
708-01103000006d	900mm	black
708-01104000006d	1200mm	black
708-01105000006d	1500mm	black
708-01106000006d	1800mm	black
708-01107000006d	2100mm	black
708-01108000006d	2400mm	black

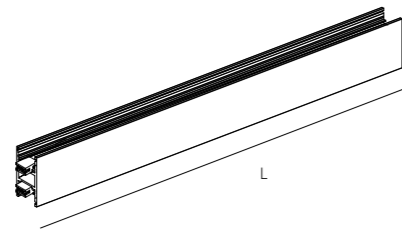
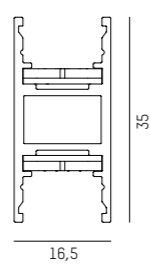

ENDSTÜCK END PIECE	FARBE COLOUR
708-006020000060	black

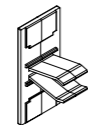

IP20 CE

JUNCTION

LINEARVERBINDER LINEAR JUNCTION	FARBE COLOUR
708-005060000060	aluminium

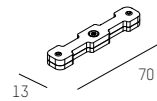

90° VERBINDER 90° JUNCTION	FARBE COLOUR
708-00507000006d	black

inkl. 2 Stk. Platinenverbinder
incl. 2 pce. board junction

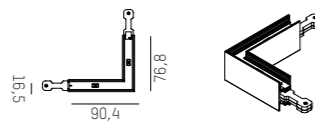

WANDHALTERUNG WALL BRACKET	FARBE COLOUR
708-008020000060	black

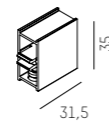

JE PROFILLÄNGE ORDERN ORDER PER PROFILE LENGTH	STÜCK COLOUR
300mm	2
600mm	2
900mm	2
1200mm	2
1500mm	2
1800mm	3
2100mm	3
2400mm	3

POWER FEED

Alle Einspeisungen für ON/Off und Dali nutzbar, je nach Modell inkl. oder exkl. DALI Repeater, Anschlussmöglichkeit für DALI ist bei allen Modellen möglich.
 ACHTUNG: Kein Push-Dimm-Betrieb möglich

All feeds for ON/Off and Dali Usable, depending on the model incl. or excl. 24V DALI repeater, connection option for DALI is possible with all models.
 ATTENTION: No push dimming operation possible

DALI REPEATER FÜR GALVANISCHE TRENNUNG DALI REPEATER FOR GALVANIC SEPERATION	LEISTUNG POWER
---	-------------------

711-sr2400amp
 max. 64 DALI Adressen
 max. 64 DALI addresses

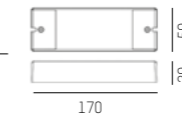

WANDEINSPEISUNG MITTE / ENDE WALL CENTER / END POWER FEED	LEISTUNG POWER	FARBE COLOUR
--	-------------------	-----------------

708-00407000006d max. 100W black
 Wandhalterung inkl. LED Konverter, inkl. Verbinder und Enddeckel
 Wall base incl. LED driver, incl. connector and end piece

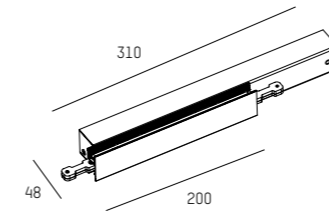

ANSCHLUSSSCHEMA / EXAMPLE OF CONNECTION

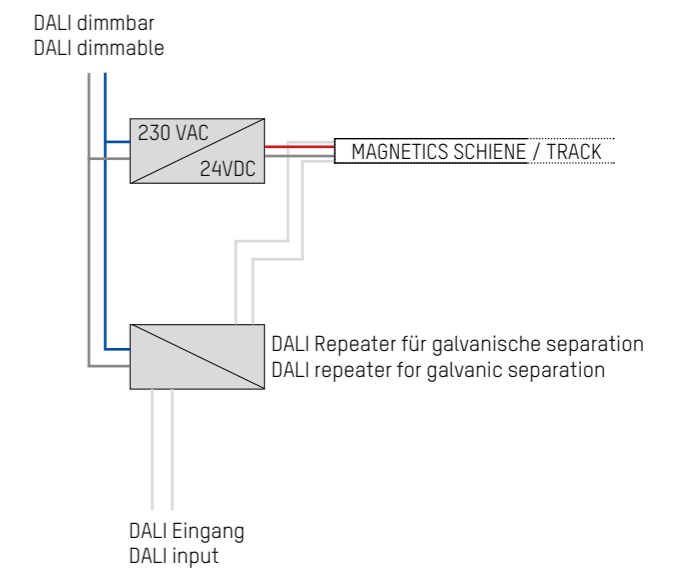
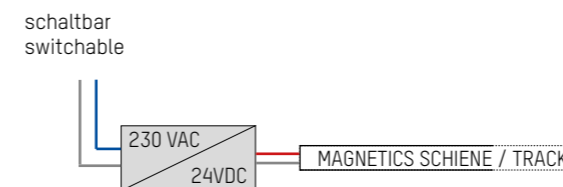

LIGHT INSERTS

LICHTEINSATZ GERADE / opal weiße oder opal schwarze Abdeckung
LIGHT INSERT STRAIGHT / opal white or black cover

SYS 2W	L: 150mm	LM
708-00301COWW06Y		50 - 135

SYS 4W	L: 300mm	LM
708-00303COWW06Y		100 - 270

SYS 6W	L: 450mm	LM
708-00306COWW06Y		150 - 405

SYS 8W	L: 600mm	LM
708-00304COWW06Y		200 - 540

SYS 12W	L: 900mm	LM
708-00305COWW06Y		300 - 810

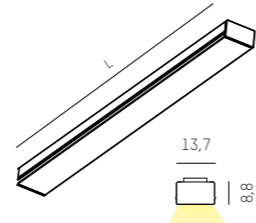

Opal Lichteinsatz
Opal light insert



Opal schwarze Abdeckung - Licht aus
Opal black cover - light off



Opal schwarze Abdeckung - Licht an
Opal black cover - light on

COMPLETE CODE		
C = COVER	WW = LIGHT COLOUR	Y = DIMMABLE
<ul style="list-style-type: none"> opal white = 1 opal black = 4 	<ul style="list-style-type: none"> W2 LED 2700K = 23 CRI>90 W3 LED 3000K = 29 CRI>90 W4 LED 4000K = 24 CRI>90 	<ul style="list-style-type: none"> S switchable = 0 D DALI dimm. = d

LICHEINSATZ GRID / chrom oder dark chrom Reflektor
LIGHT INSERT GRID / chrome or dark chrome reflector

SYS 4W	L: 150mm	LM
708-00301ROWW06Y		110 - 310

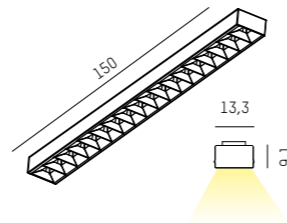

Dark Chrom 60° Lichtaustritt
Darkchrome 60° light beam

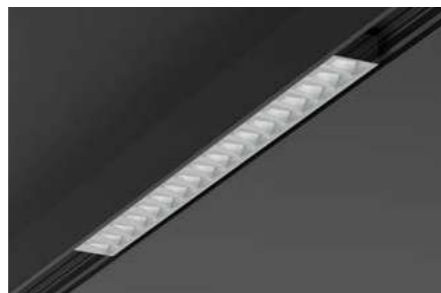

Chrom asymmetrischer Lichtaustritt
Chrome asymmetric light beam



MAGNETICS SYSTEM INSERTS

COMPLETE CODE		
R = REFLECTOR	WW = LIGHT COLOUR	Y = DIMMABLE
<ul style="list-style-type: none"> dark chrome - 60° beam = 2 (UGR<16) chrome - asymmetric beam = 3 	<ul style="list-style-type: none"> W2 LED 2700K = 23 CRI>90 W3 LED 3000K = 29 CRI>90 W4 LED 4000K = 24 CRI>90 	<ul style="list-style-type: none"> S switchable = 0 D DALI dimm. = d

060

LIGHT INSERTS

SPOT S EINSATZ / mit Linse
SPOT S INSERT / with lens

SYS 4W	LM
708-00201RRWW06Y	290 - 360

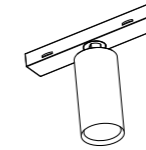
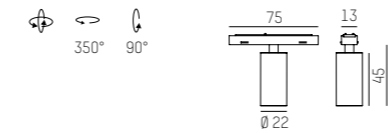

COMPLETE CODE		
RR = LENS	WW = LIGHT COLOUR	Y = DIMMABLE
<ul style="list-style-type: none"> 20° lens = 04 30° lens = 06 	<ul style="list-style-type: none"> W2 LED 2700K = 43 PREMIUM CRI>90 W3 LED 3000K = 49 PREMIUM CRI>90 W4 LED 4000K = 24 CRI>90 	<ul style="list-style-type: none"> S switchable = 0 D DALI dimm. = d

SPOT M EINSATZ / mit Reflektor
SPOT M INSERT / with reflector

SYS 7W	LM
708-00202RRWW06Y	210 - 480

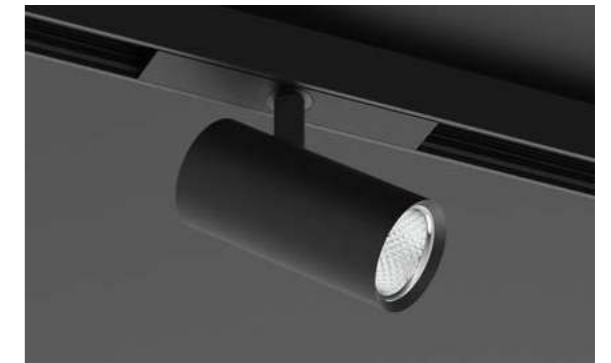
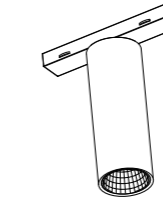
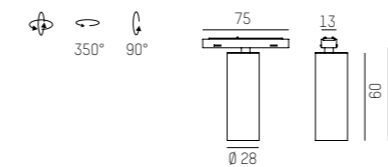

COMPLETE CODE		
RR = REFLECTOR	WW = LIGHT COLOUR	Y = DIMMABLE
<ul style="list-style-type: none"> 24° chrome = 02 38° chrome = 03 24° dark chrome = 08 38° dark chrome = 09 	<ul style="list-style-type: none"> W2 LED 2700K = 43 PREMIUM CRI>90 W3 LED 3000K = 49 PREMIUM CRI>90 W4 LED 4000K = 24 CRI>90 	<ul style="list-style-type: none"> S switchable = 0 D DALI dimm. = d

SPOT L EINSATZ / mit Linse oder Reflektor
SPOT L INSERT / with lens or reflector

SYS 11 - 15W	LM
708-00203RRWW06Y	640 - 1130

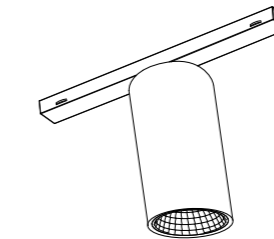
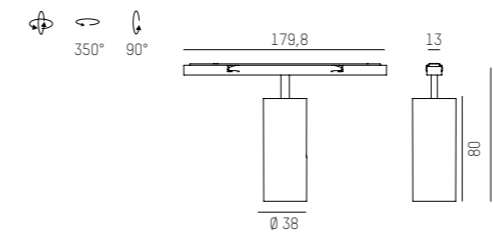

Auf Anfrage auch mit Honeycomb erhältlich / On request also available with honeycomb

COMPLETE CODE			
RR = OPTIC	WW = LIGHT COLOUR	Y = DIMMABLE	
<ul style="list-style-type: none"> 14° lens = 04 24° lens = 05 45° lens = 06 	<ul style="list-style-type: none"> 24° chrome = 02 45° chrome = 03 	<ul style="list-style-type: none"> 24° dark chrome = 08 45° dark chrome = 09 	<ul style="list-style-type: none"> W2 LED 2700K = 43 PREMIUM CRI>90 W3 LED 3000K = 49 PREMIUM CRI>90 W4 LED 4000K = 24 CRI>90
<ul style="list-style-type: none"> S switchable = 0 D DALI dimm. = d 			

061

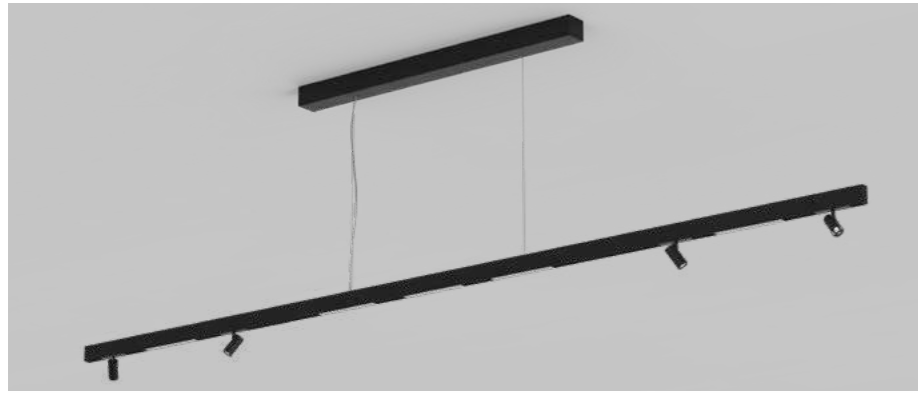

MAGNETICS H PDI
24V DC

Design: INHOUSE

Pendelleuchte aus Aluminiumprofil · Oberfläche schwarz · Direkt- / Indirekt Trackplatine · Lichteinsätze separat ordern
 Pendant luminaire made of aluminium profile · black surface · direct/indirect track circuit board · light inserts to be ordered separately
 Lampada a sospensione in alluminio · finitura nera · scheda di circuito diretta ed indiretta · inserti luminosi da ordinare separatamente
 Suspension en aluminium · finition noire · circuit imprimé direct et indirect · inserts lumineux à commander séparément

L: 1403mm
708-01016000006d
 inkl. DALI Repeater
 Lichteinsätze separat ordern (S. 060-061)
 incl. DALI repeater
 order light inserts sepately (p. 060-061)

L: 2003mm
708-01017000006d
 inkl. DALI Repeater
 Lichteinsätze separat ordern (S. 060-061)
 incl. DALI repeater
 order light inserts sepately (p. 060-061)

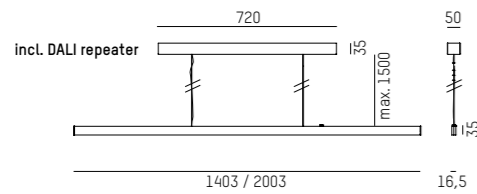

L: 1403mm
708-01018000006d
 exkl. DALI Repeater
 Lichteinsätze separat ordern (S. 060-061)
 excl. DALI repeater
 order light inserts sepately (p. 060-061)

L: 2003mm
708-01019000006d
 exkl. DALI Repeater
 Lichteinsätze separat ordern (S. 060-061)
 excl. DALI repeater
 order light inserts sepately (p. 060-061)

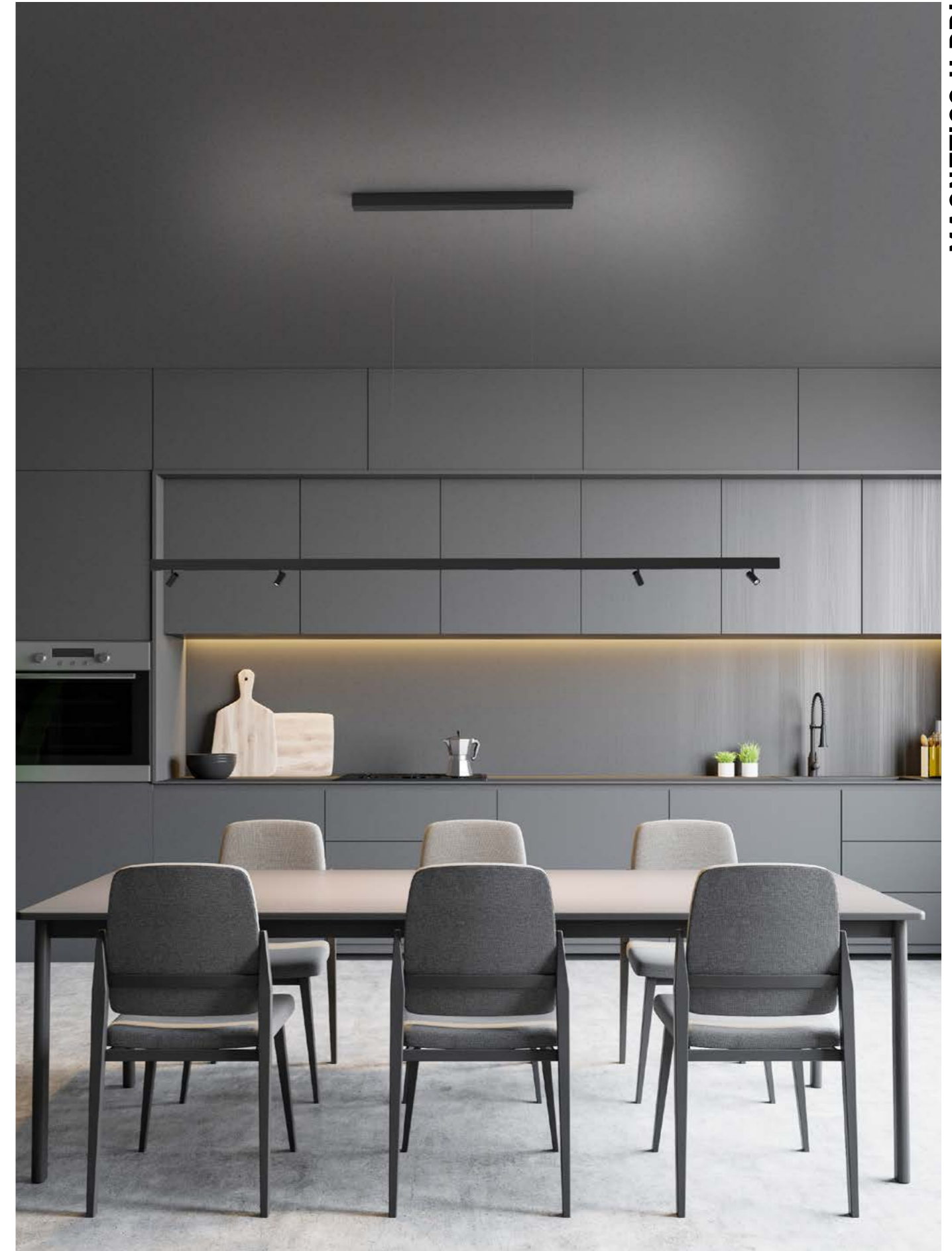
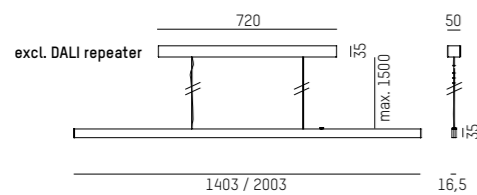

MAGNETICS H PDI

Technical data and energy efficiency



MAGNETICS H PDI



MAGNETICS H W
24V DC

Design: INHOUSE

Wandleuchte aus Aluminiumprofil · Oberfläche schwarz · ohne DALI Repeater · Lichteinsätze separat ordern
 Wall luminaire made of aluminium profile · black surface · without DALI repeater · order light inserts separately
 Lampada a parete in alluminio · finitura nera · senza DALI ripetitore · inserti luminosi da ordinare separatamente
 Applique en aluminium · finition noire · sans DALI répéteur · inserts lumineux à commander séparément

TRACK

L: 1403mm
708-00909000006d
 Lichteinsätze separat ordern (S. 060-061)
 order light inserts sepately (p. 060-061)

L: 2003mm
708-00910000006d
 Lichteinsätze separat ordern (S. 060-061)
 order light inserts sepately (p. 060-061)

INDIRECT BEAM
DIRECT TRACK



SYS 18W L: 1403mm **LM**
708-0091200WW06d 1219
 für direkt Einsätze separat ordern (S. 060-061)
 order inserts for direct sepately (p. 060-061)

SYS 26W L: 2003mm **LM**
708-0091300WW06d 1749
 für direkt Einsätze separat ordern (S. 060-061)
 order inserts for direct sepately (p. 060-061)

DIRECT
INDIRECT BEAM



SYS 36W L: 1403mm **LM**
708-0091400WW06Y 2438

SYS 52W L: 2003mm **LM**
708-0091500WW06Y 3498

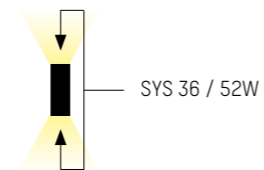
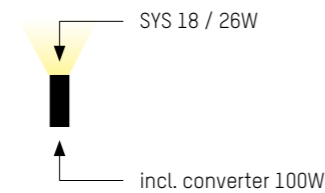
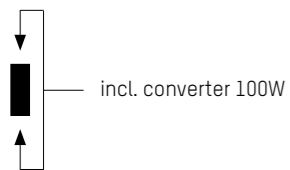
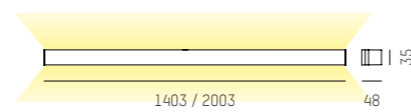

COMPLETE CODE	
WW = LIGHT COLOUR	Y = DIMMABLE
W2 LED 2700K = 23 CRI<90	Ⓢ switchable = 0
W3 LED 3000K = 29 CRI<90	Ⓣ DALI dimm. = d
W4 LED 4000K = 24 CRI<90	

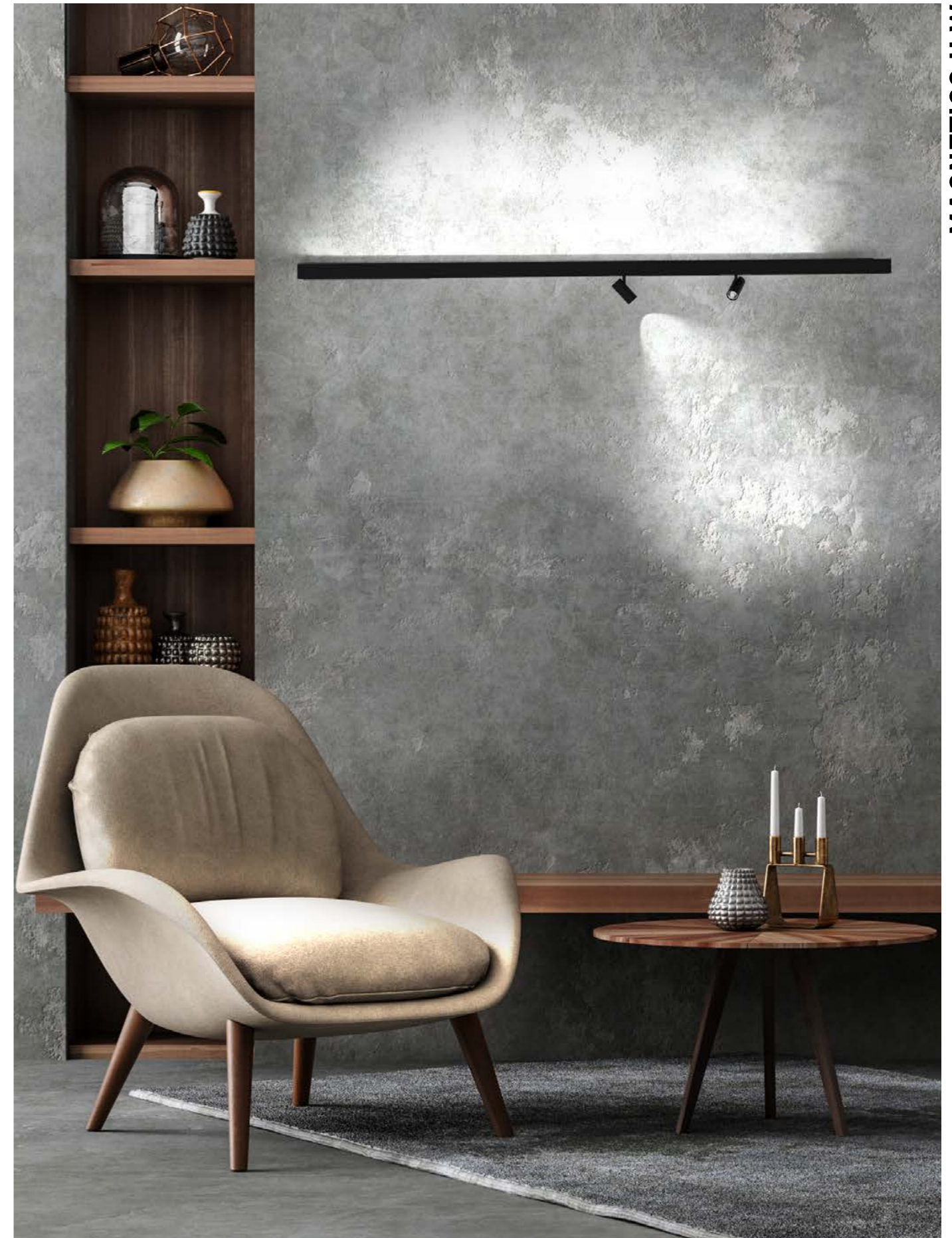

Technical data and energy efficiency



MAGNETICS F
24V DC

Design: INHOUSE

Stehleuchte aus Aluminiumprofil · Oberfläche schwarz · direkt- / indirekt strahlend · Lichteinsätze direktstrahlend separat ordern
 Floor luminaire made of aluminium profile · black surface · direct/indirect distribution · light inserts direct distribution to be ordered separately
 Lampada da terra in alluminio · finitura nera · illuminazione diretta ed indiretta · inserti luminosi per illuminazione diretta da ordinare separatamente
 Lampadaire en aluminium · finition noire · éclairage direct et indirect · inserts lumineux pour l'éclairage direct à commander séparément

INDIRECT BEAM 
 DIRECT TRACK

SYS 24W	H: 1898mm	LM
708-0120610	WW06d	1590

für direkt Einsätze separat ordern (S. 060-061)
 order inserts for direct sepately (p. 060-061)

TASTER DARK
 708-00003000006d
 Zum dimmen und EIN/AUS an der Leuchte
 Direkt- / indirekt getrennt schaltbar bzw. dimmbar
 for dimming an ON/OFF on the Luminaire
 direct- / indirect separate switchable or dimmable

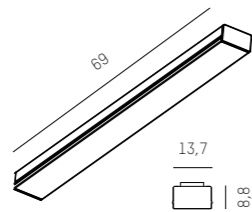
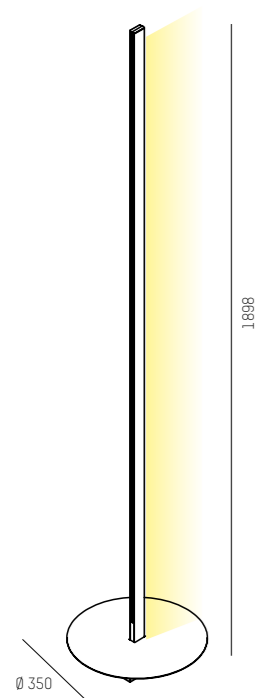

COMPLETE CODE	
WW	= LIGHT COLOUR
W2	LED 2700K = 23 CRI<90
W3	LED 3000K = 29 CRI<90
W4	LED 4000K = 24 CRI<90



Technical data and energy efficiency



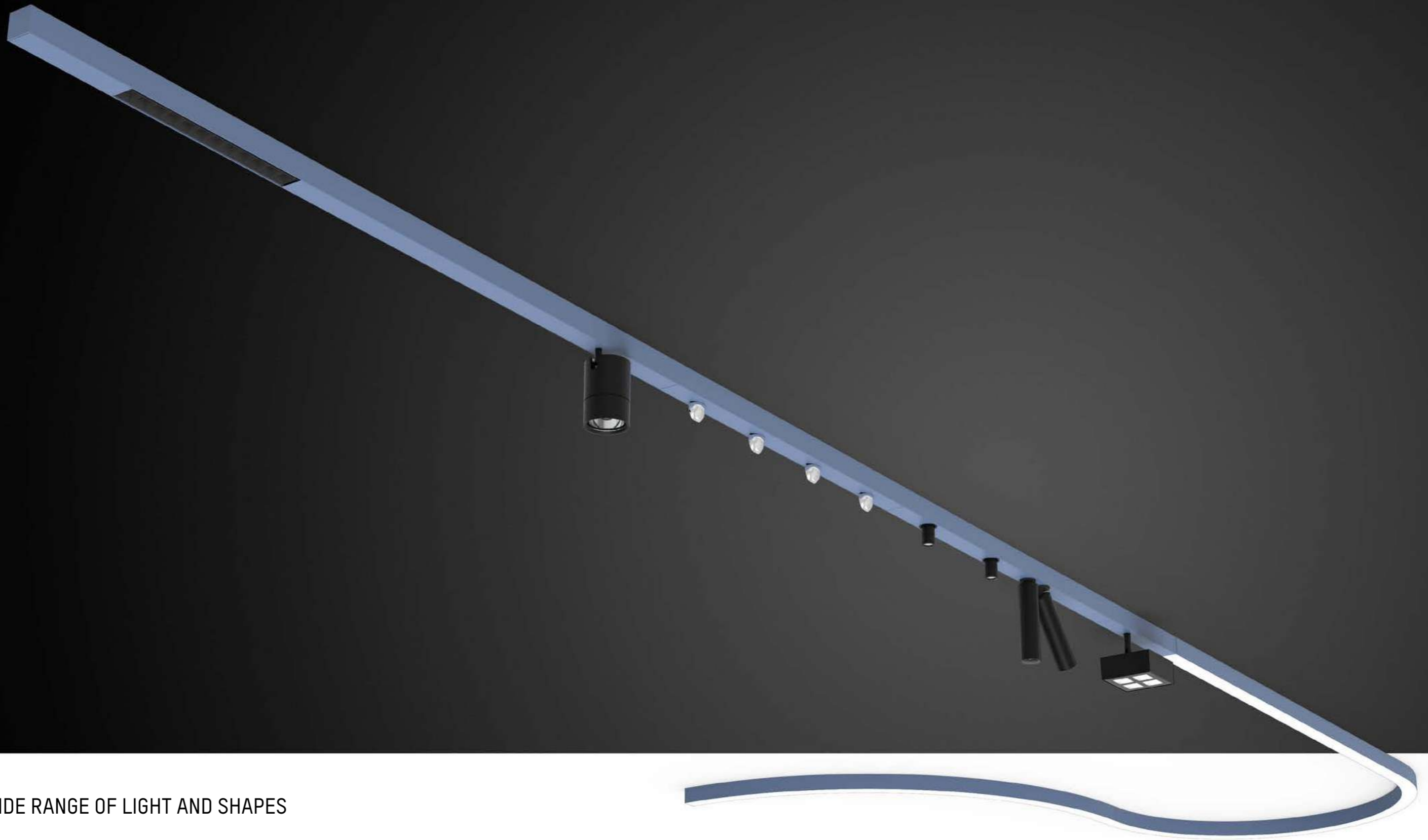

WIDE RANGE OF LIGHT AND SHAPES

Ride ist mit einem Querschnitt von nur 35x35mm eines der schlanksten LED-Lichtbandsysteme, die auf dem Markt angeboten werden. Das Besondere: Ride stellt aufgrund eines im System integrierten Konverters auch bei Längen von bis zu 15m einen durchgängigen Lichtaustritt sicher. Gefertigt aus einem stranggepressten Aluminiumprofil bringt Ride eine enorme Varianten-Vielfalt mit sich um unterschiedliche Erfordernisse abzudecken.

With a cross-section of just 35x35mm, Ride is one of the slimmest linear LED profile systems on the market. Due to an integrated converter, Ride can guarantee continuous light emission along lengths of up to 15m. Made from an extruded aluminum profile, Ride offers an enormous variety of variants to cover different requirements.

Design: INHOUSE

RIDE



Private residence
Austria
Interior Design: Leibez

Tischlerei Berger
Ratten, Austria
Photo: Joachim Rauch



Blick über Wien
 Vienna, Austria
 MSG Innenarchitektur & Bauplanungs GmbH / facebook.com/MayrundGlatz
 Photo: Gabriel Büchelmeier



Pre-school
 Peggau, Austria
 Photo: Joachim Rauch

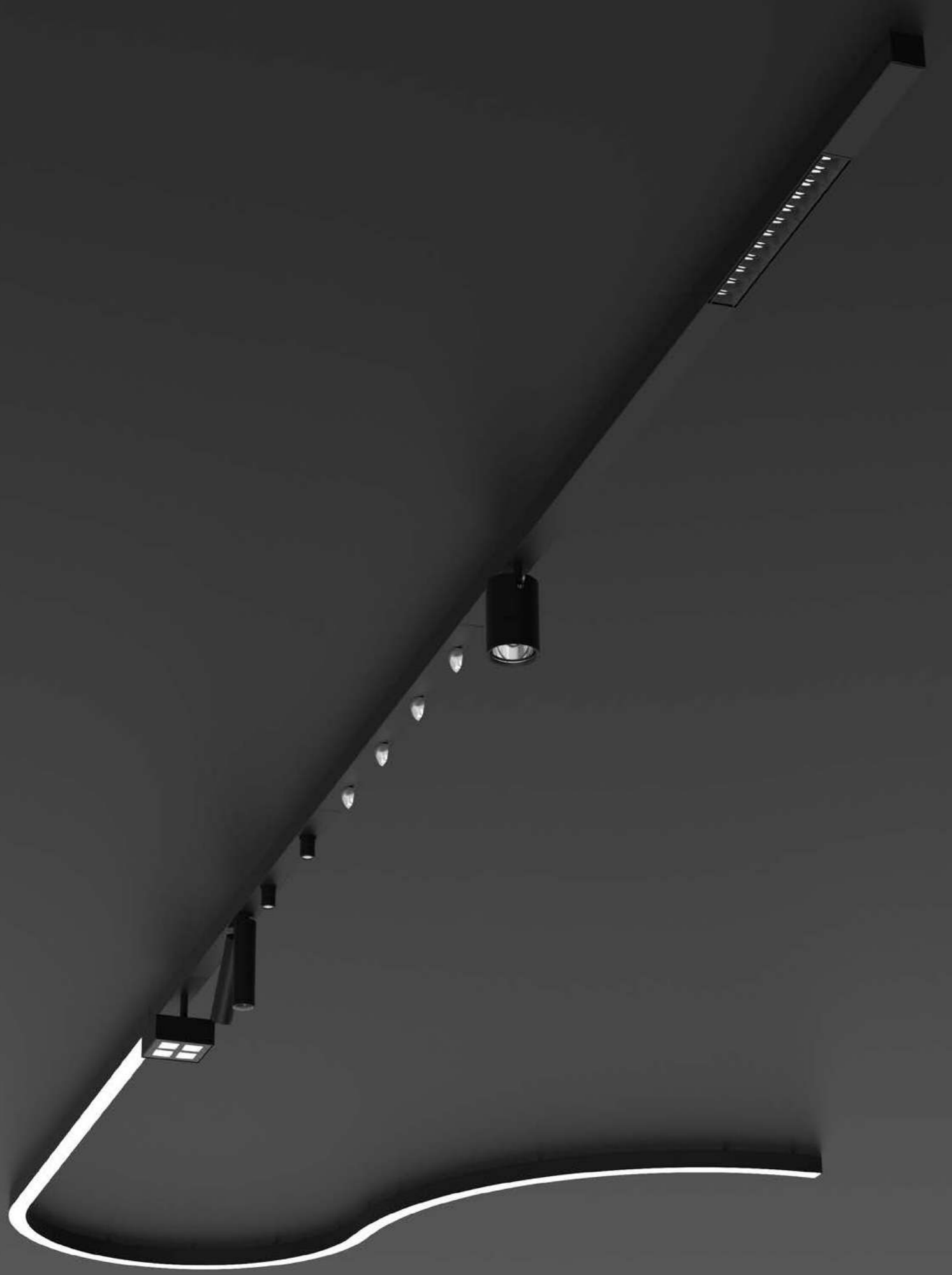

System versions

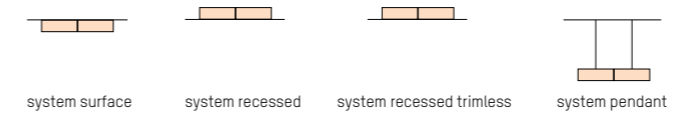

Profile

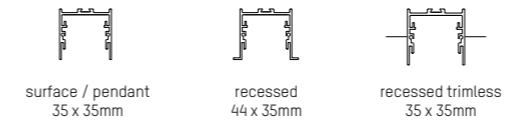

Form

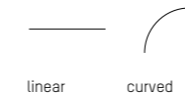

Core Colours

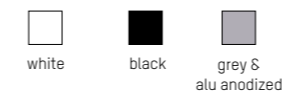

Creative Colours

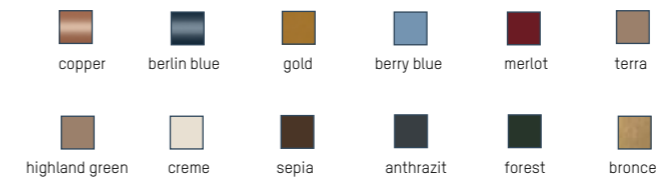

Optics & Cover

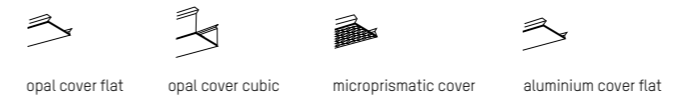

System inserts

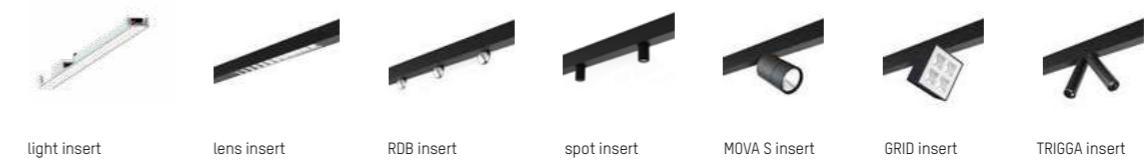

Light beam

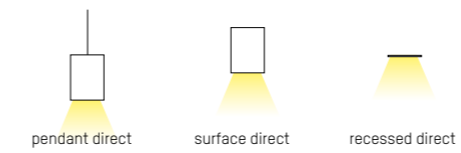

LED Colours



Design: INHOUSE

Configurate RIDE SYSTEM



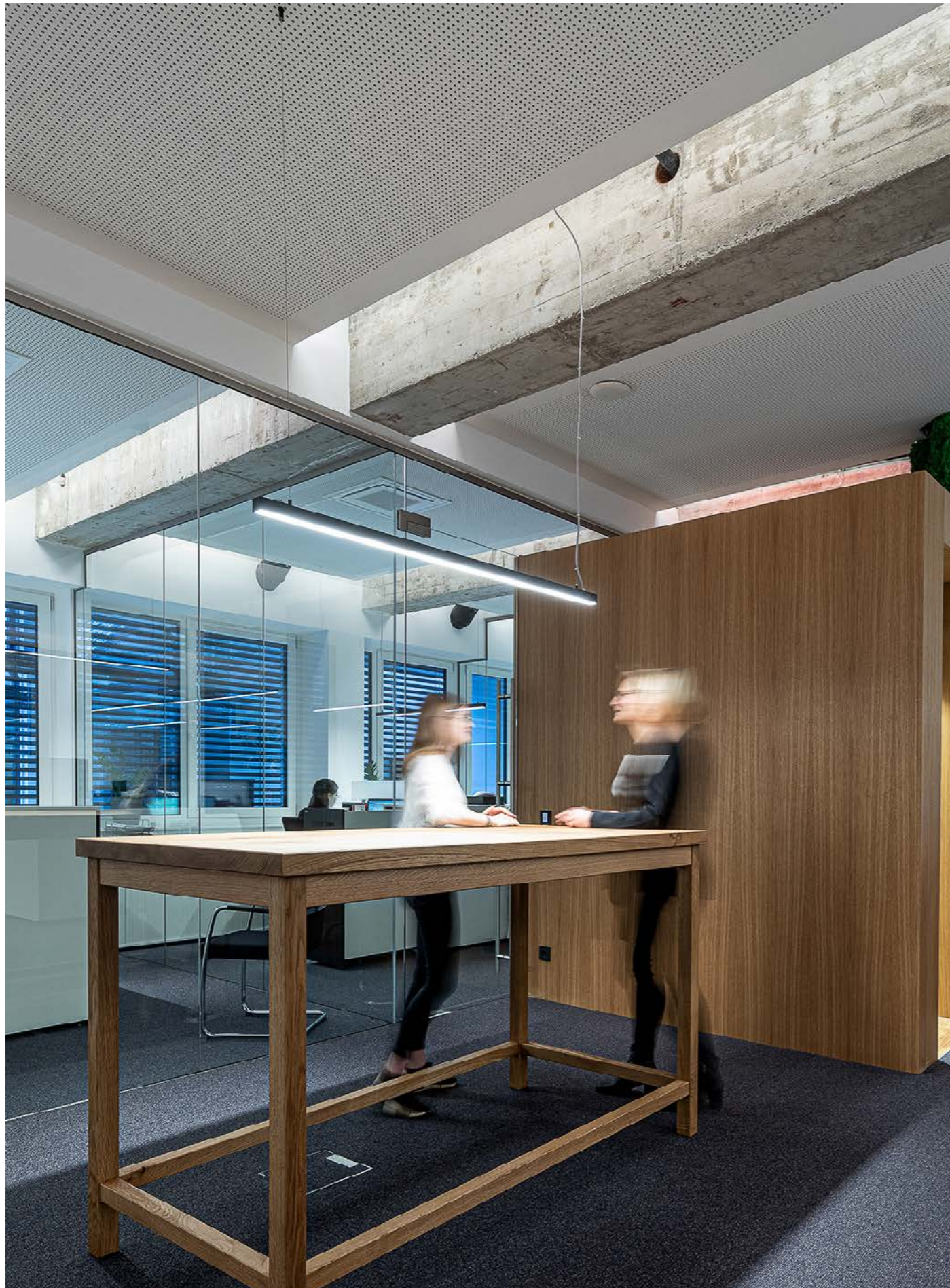

Saller & Saller Steuerberatungskanzlei
 Bischofshofen, Austria
 Photo: Stefan Zauner



Wimbergher Haus
 Lasberg, Austria
 Planing & Realisation: Ben Elmecker
 Photo: Joachim Rauch





Single versions

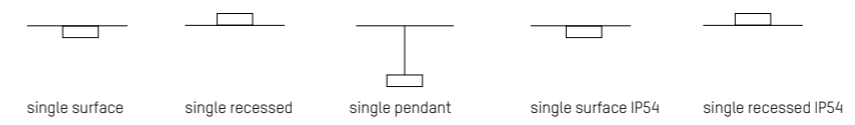

Profile

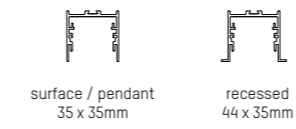

Form



Core Colours

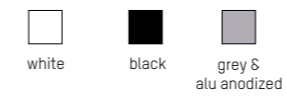

Creative Colours

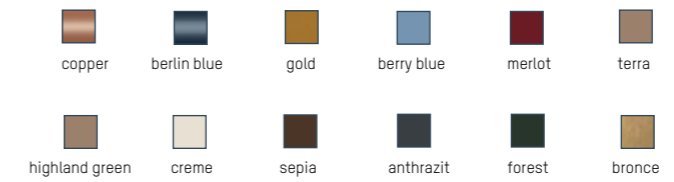

Versions

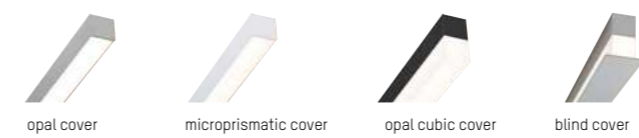

Light beam

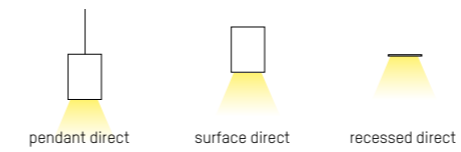

LED Colours



Design: INHOUSE

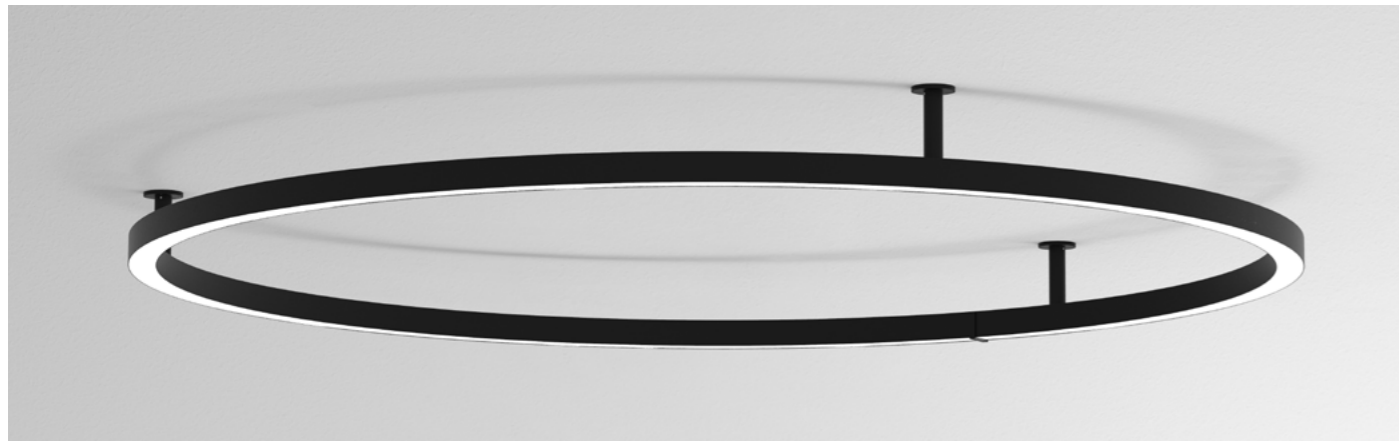

RIDE RING SD OPAL DIFFUSER

220-240V AC 50/60Hz Design: INHOUSE

LED Ringleuchte aus Aluminiumprofil · Oberfläche pulverbeschichtet · LED Konverter im Leuchtenprofil integriert · für Decken- und Wandmontage geeignet
 LED ring luminaire, extruded aluminium · surface powder-coated · built-in LED converter in profile · suitable for wall and ceiling installation
 Lampada in alluminio estruso · superficie verniciata a polveri · converter LED integrato nel profilo · adatta per il montaggio a parete o a soffitt
 Lampe en forme d'anneau en aluminium extrudé · surface lacquée en poudre · convertiseur intégré dans le profil

SYS 38W	Ø: 750mm	LM	SYS 76W	Ø: 1450mm	LM
675-1010110WWXXY		3300 - 3730	675-1020110WWXXY		6610 - 7470

DECKENDISTANZ KURZ
 CEILING DISTANCE SHORT
 675-418000000XX

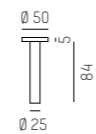

DECKENDISTANZ LANG
 CEILING DISTANCE LONG
 675-419000000XX

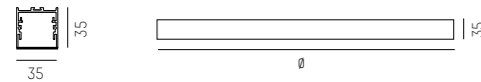
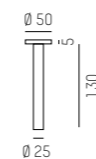

IP20

COMPLETE CODE		
WW = LIGHT COLOUR	XX = COLOUR	Y = DIMMABLE
W2 LED 2700K = 23 CRI>90	G grey = 04	D DALI dimm. = d
W3 LED 3000K = 29 CRI>90	W white = 05	
W4 LED 4000K = 24 CRI>90	S black = 06	



RIDE RING SD

Technical data and energy efficiency

Tourismusverband
 Obertauern, Austria
 GMP Architektur ZT KG, www.gmp-architektur.at



RIDE RING SD

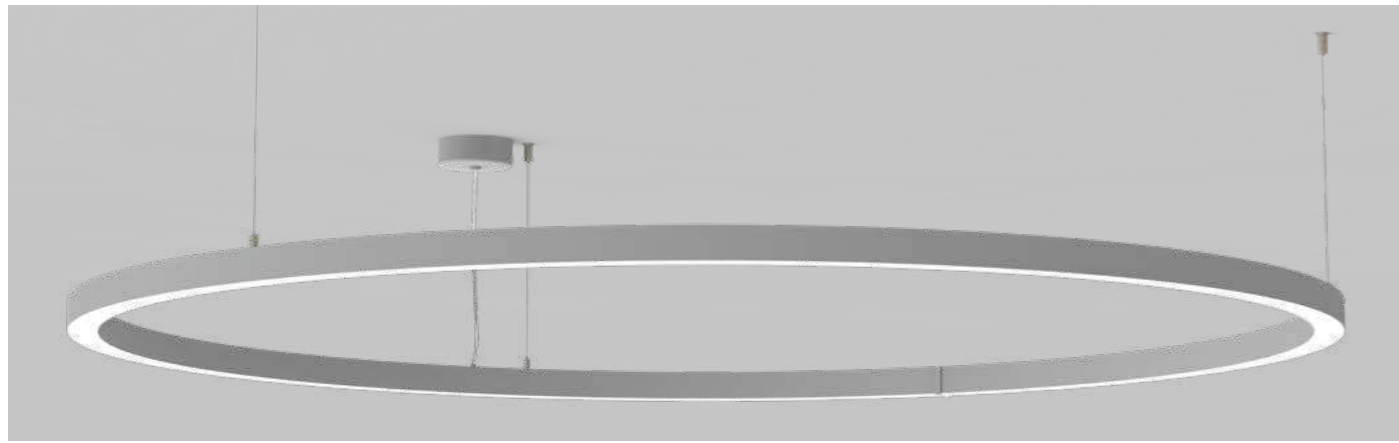

RIDE RING PD OPAL DIFFUSER

220-240V AC 50/60Hz Design: INHOUSE

LED Ringleuchte aus Aluminiumprofil · Oberfläche pulverbeschichtet · LED Konverter im Leuchtenprofil integriert · für Decken- und Wandmontage geeignet
 LED ring luminaire, extruded aluminium · surface powder-coated · built-in LED converter in profile · suitable for wall and ceiling installation
 Lampada in alluminio estruso · superficie verniciata a polveri · converter LED integrato nel profilo · adatta per il montaggio a parete o a soffitt
 Lampe en forme d'anneau en aluminium extrudé · surface lacquée en poudre · convertiseur intégré dans le profil

SYS 38W	Ø: 750mm	LM	SYS 76W	Ø: 1450mm	LM
675-2010110	WWXXY	3300 - 3730	675-2020110	WWXXY	6610 - 7470

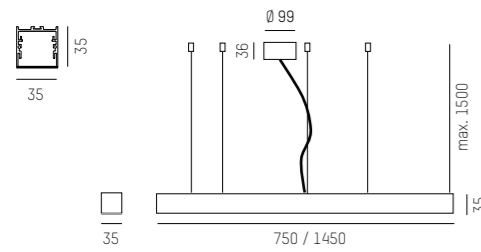

IP20



COMPLETE CODE																
WW = LIGHT COLOUR	XX = COLOUR	Y = DIMMABLE														
<table border="0"> <tr><td>W2</td><td>LED 2700K = 23 CRI>90</td></tr> <tr><td>W3</td><td>LED 3000K = 29 CRI>90</td></tr> <tr><td>W4</td><td>LED 4000K = 24 CRI>90</td></tr> </table>	W2	LED 2700K = 23 CRI>90	W3	LED 3000K = 29 CRI>90	W4	LED 4000K = 24 CRI>90	<table border="0"> <tr><td>G</td><td>grey = 04</td></tr> <tr><td>W</td><td>white = 05</td></tr> <tr><td>S</td><td>black = 06</td></tr> </table>	G	grey = 04	W	white = 05	S	black = 06	<table border="0"> <tr><td>D</td><td>DALI dimm. = d</td></tr> </table>	D	DALI dimm. = d
W2	LED 2700K = 23 CRI>90															
W3	LED 3000K = 29 CRI>90															
W4	LED 4000K = 24 CRI>90															
G	grey = 04															
W	white = 05															
S	black = 06															
D	DALI dimm. = d															

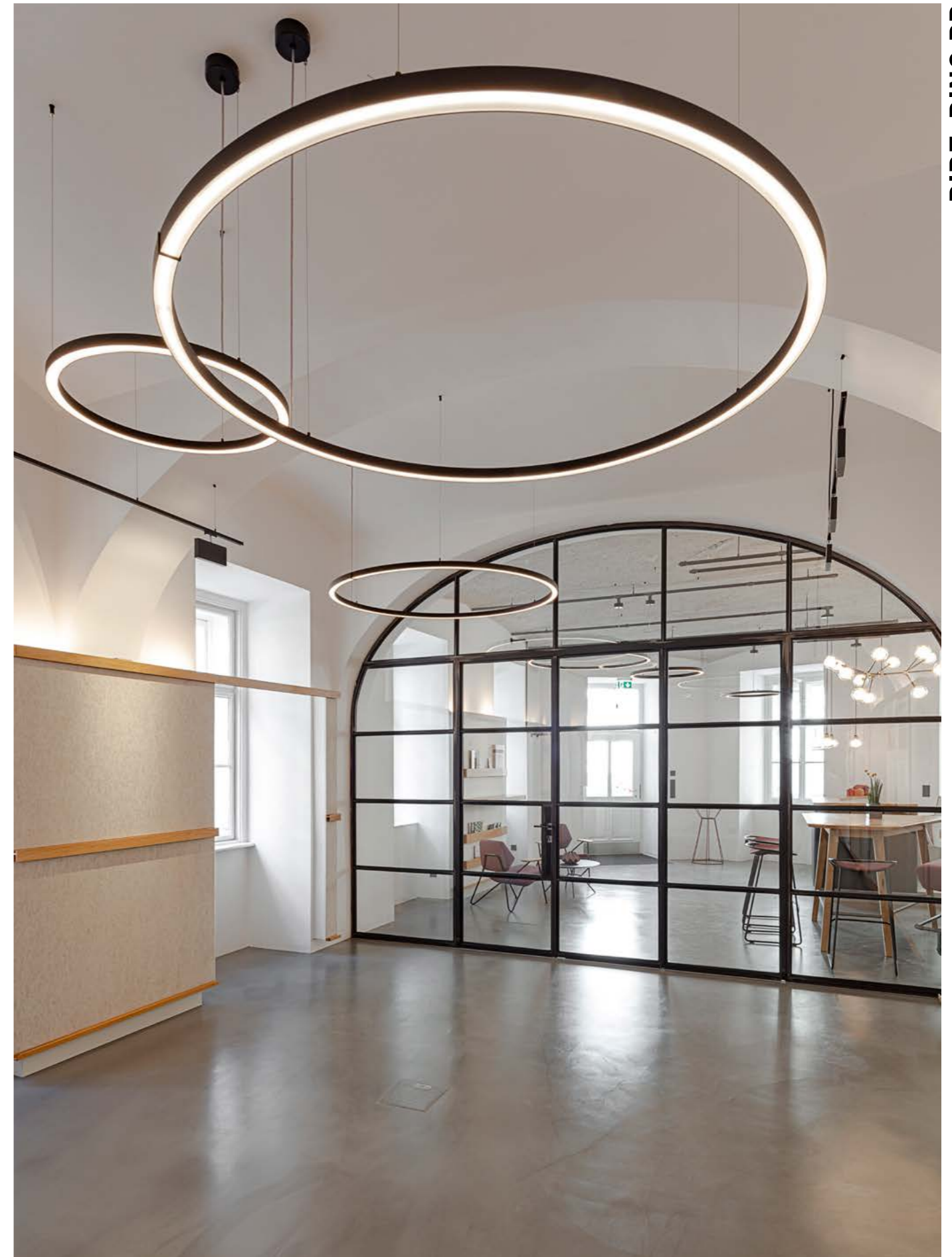

RIDE RING PD

Technical data and energy efficiency

Wohnfonds M&G
 Vienna, Austria
 M&G Innenarchitektur & Bauplanungs GmbH / facebook.com/MayrundGlatz
 Photo: Gabriel Büchelmeier



RIDE RING PD



RIDE SD OPAL OR MICROPRISMATIC DIFFUSER

220-240V AC 50/60Hz Design: INHOUSE

LED Aufbauleuchte aus Aluminiumprofil · Oberfläche pulverbeschichtet oder eloxiert · Opale oder mikroprismatische Abdeckung · Schaltbar oder DALI dimm.
 LED surface luminaire from aluminium profile · surface powder-coated or anodized · opal or microprismatic cover · switchable or DALI dimmable
 Lampada LED a plafone con profilo in alluminio · Superficie verniciata a polveri o anodizzata · Diffusore opale o microprismatico · On/off o dimmerabile DALI
 Plafonnier LED en profilé d'aluminium · surface lacquée en poudre ou anodisée · Diffuseur opale ou microprismatique · On/off ou dimmable DALI

SYS 10W	L: 577mm	LM	SYS 15W	L: 857mm	LM	SYS 19W	L: 1137mm	LM
577-01001COWWXXO		780 - 1050	577-01002COWWXXY		1170 - 1570	577-01003COWWXXY		1560 - 2100
not dimmable								

SYS 24W	L: 1417mm	LM	SYS 48W	L: 2817mm	LM	SYS 71W	L: 4217mm	LM
577-01004COWWXXY		1950 - 2620	577-01005COWWXXY		3910 - 5250	577-01006COWWXXY		5870 - 7870



IP20

COMPLETE CODE			
C = COVER	WW = LIGHT COLOUR	XX = COLOUR	Y = DIMMABLE
opal flat = 1	LED 2700K = 23 CRI>90	white = 05	switchable = 0
opal cubic = 2	LED 3000K = 29 CRI>90	black = 06	DALI dimm. = d
microprismatic flat = 3	LED 4000K = 24 CRI>90	alu anodized = 08	

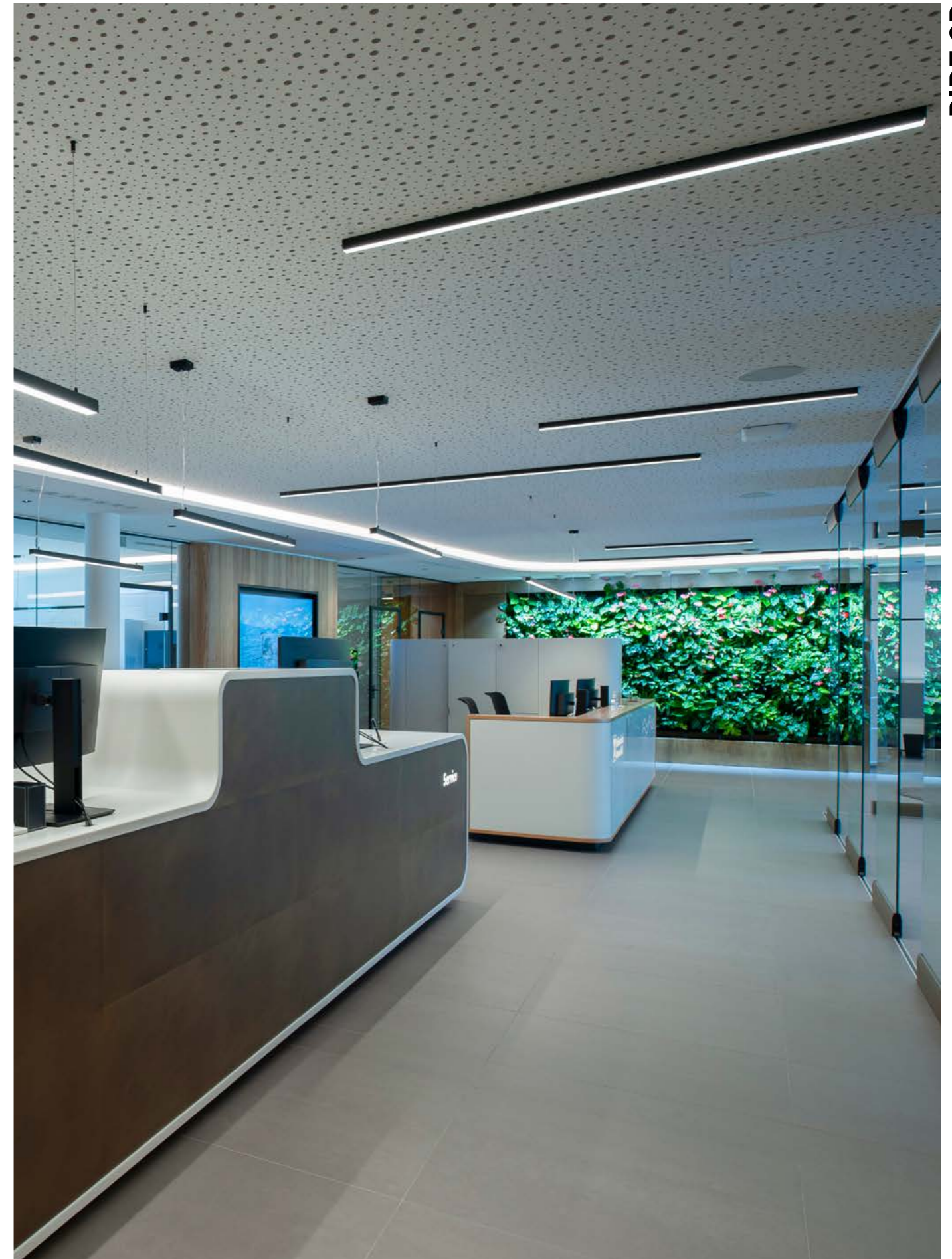

RIDE SD

Technical data and energy efficiency

Raiffeisenbank Attersee-Süd
 Nußdorf, Austria
 Design + Architektur AREA.at
 Photo: Joachim Rauch



RIDE SD



RIDE IP54 SD

220-240V AC 50/60Hz Design: INHOUSE

OPAL DIFFUSER

LED Aufbauteuchte aus Aluminiumprofil · Oberfläche pulverbeschichtet oder eloxiert · Opale Abdeckung · Schaltbar oder DALI dimmbar · IP54
 LED surface luminaire from aluminium profile · surface powder-coated or anodized · opal cover · switchable or DALI dimmable · IP54
 Lampada LED a plafone con profilo in alluminio · Superficie verniciata a polveri o anodizzata · Diffusore opale · On/off o dimmerabile DALI · IP54
 Plafonnier LED en profilé d'aluminium · surface lacquée en poudre ou anodisée · Diffuseur opale · On/off ou dimmable DALI · IP54

SYS 10W	L: 577mm	LM	SYS 15W	L: 857mm	LM	SYS 19W	L: 1137mm	LM
577-01301COWWXXO		820 - 1050	577-01302COWWXXY		1230 - 1570	577-01303COWWXXY		1650 - 2100
not dimmable								
SYS 24W	L: 1417mm	LM	SYS 48W	L: 2817mm	LM	SYS 71W	L: 4217mm	LM
577-01304COWWXXY		2060 - 2620	577-01305COWWXXY		4130 - 5250	577-01306COWWXXY		6190 - 7870



IP54

COMPLETE CODE			
C = COVER	WW = LIGHT COLOUR	XX = COLOUR	Y = DIMMABLE
opal flat = 1	LED 2700K = 23 CRI>90	white = 05	switchable = 0
opal cubic = 2	LED 3000K = 29 CRI>90	black = 06	DALI dimm. = d
	LED 4000K = 24 CRI>90	alu anodized = 08	

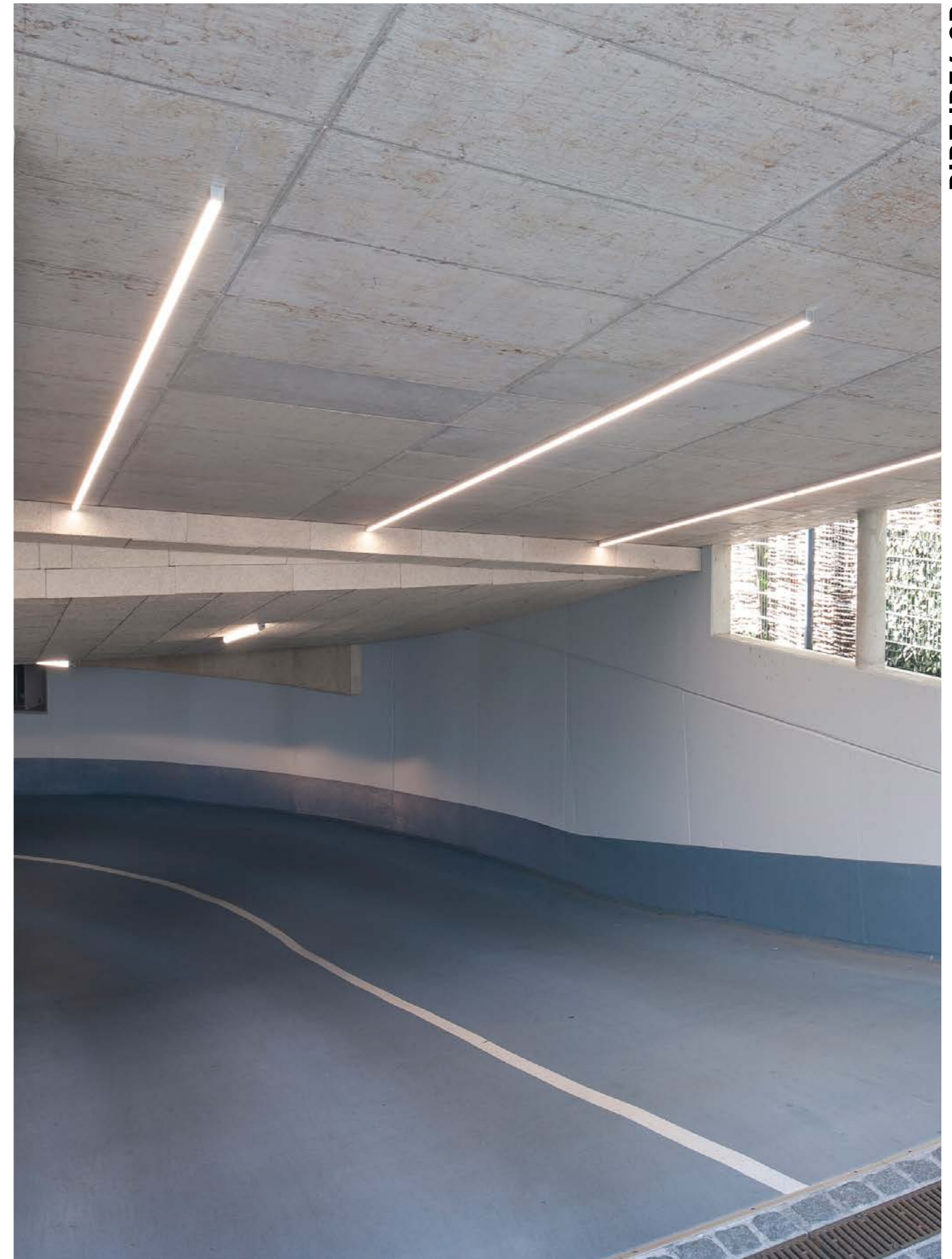

RIDE IP54 SD

Technical data and energy efficiency

Hotel Südsterne
 Munich, Germany
 Photo: Joachim Rauch



RIDE IP54 SD



RIDE BLIND SI

220-240V AC 50/60Hz Design: INHOUSE

CUBIC DIFFUSER WITH COVER

LED Aufbauleuchte aus Aluminiumprofil · Oberfläche pulverbeschichtet oder eloxiert · für Decken- und Wandmontage · kubische Abdeckung mit Blende
 LED surface luminaire from aluminium profile · surface powder-coated or anodized · for ceiling and wall mount · cubic diffuser with cover
 Lampada LED a plafone con profilo in alluminio · Superficie verniciata a polveri o anodizzata · per soffitto e a parete · diffusore cubico ad blenda
 Plafonnier LED en profilé d'aluminium · surface lacquée en poudre ou anodisée · pour installation à plafond ou paroi · diffuseur cubique avec blende

SYS 10W	L: 597mm	LM	SYS 15W	L: 877mm	LM
577-0080120 WWXX0		460 - 520	577-0080220 WWXXY		690 - 780
not dimmable					
SYS 19W	L: 1157mm	LM	SYS 24W	L: 1437mm	LM
577-0080320 WWXXY		920 - 1040	577-0080420 WWXXY		1150 - 1300

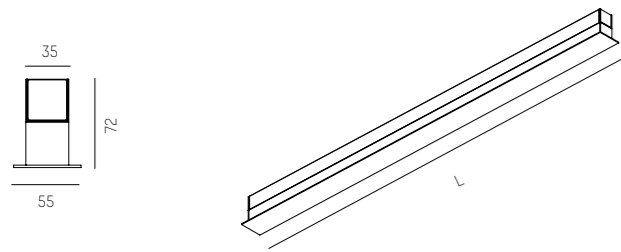

IP20



ARTIKELNUMMER ERGÄNZEN / COMPLETE CODE		
WW = LICHTFARBE / LIGHT COLOUR	XX = FARBE / COLOUR	Y = DIMMBAR / DIMMABLE
W2 LED 2700K = 23 CRI>90	W white = 05	S switchable = 0
W3 LED 3000K = 29 CRI>90	S black = 06	D DALI dimm. = d
W4 LED 4000K = 24 CRI>90	AE alu anodized = 08	

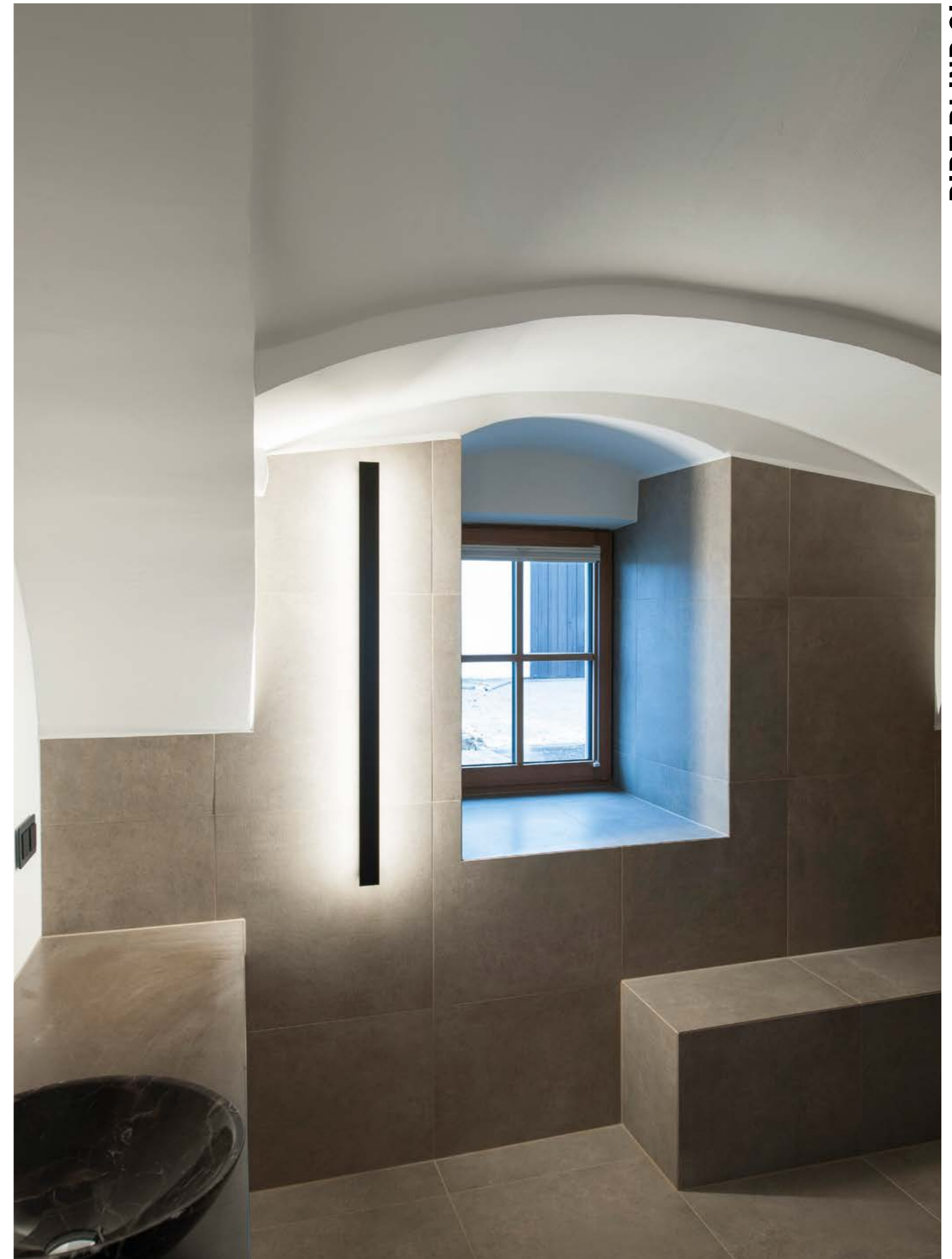

Technical data and energy efficiency



Private residence
Austria
Photo: Joachim Rauch



RIDE PD 220-240V AC 50/60Hz Design: INHOUSE **OPAL OR MICROPRISMATIC DIFFUSER**

LED Pendelleuchte aus Aluminiumprofil · Oberfläche pulverbeschichtet oder eloxiert · Opale oder mikroprismatische Abdeckung · Schaltbar oder DALI dimm.
 LED pendant luminaire from aluminium profile · surface powder-coated or anodized · opal or microprismatic cover · switchable or DALI dimmable
 Lampada LED con profilo in alluminio · Superficie verniciata a polveri o anodizzata · Diffusore opale o microprismatico · On/off o dimmerabile DALI
 Profil en aluminium pressé de LED · surface lacquée en poudre ou anodisée · Diffuseur opale ou microprismatique · On/off ou dimmable DALI

SYS 15W	L: 857mm	LM	SYS 19W	L: 1137mm	LM	SYS 24W	L: 1417mm	LM
577-01202COWWXXY		1170 - 1570	577-01203COWWXXY		1560 - 2100	577-01204COWWXXY		1950 - 2620

SYS 48W	L: 2817mm	LM	SYS 71W	L: 4217mm	LM
577-01205COWWXXY		3910 - 5250	577-01206COWWXXY		5870 - 7870

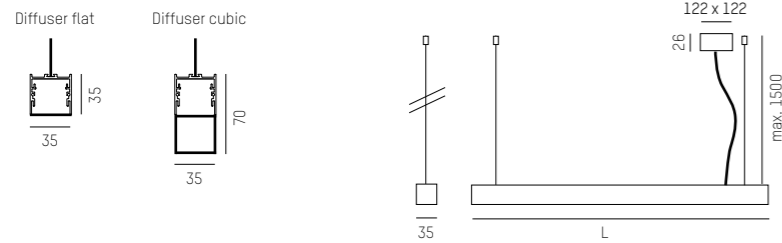

IP20 CE

COMPLETE CODE			
C = COVER	WW = LIGHT COLOUR	XX = COLOUR	Y = DIMMABLE
<ul style="list-style-type: none"> opal flat = 1 opal cubic = 2 microprismatic flat = 3 	<ul style="list-style-type: none"> W2 LED 2700K = 23 CRI>90 W3 LED 3000K = 29 CRI>90 W4 LED 4000K = 24 CRI>90 	<ul style="list-style-type: none"> W white = 05 S black = 06 AE alu anodized = 08 	<ul style="list-style-type: none"> S switchable = 0 D DALI dimm. = d

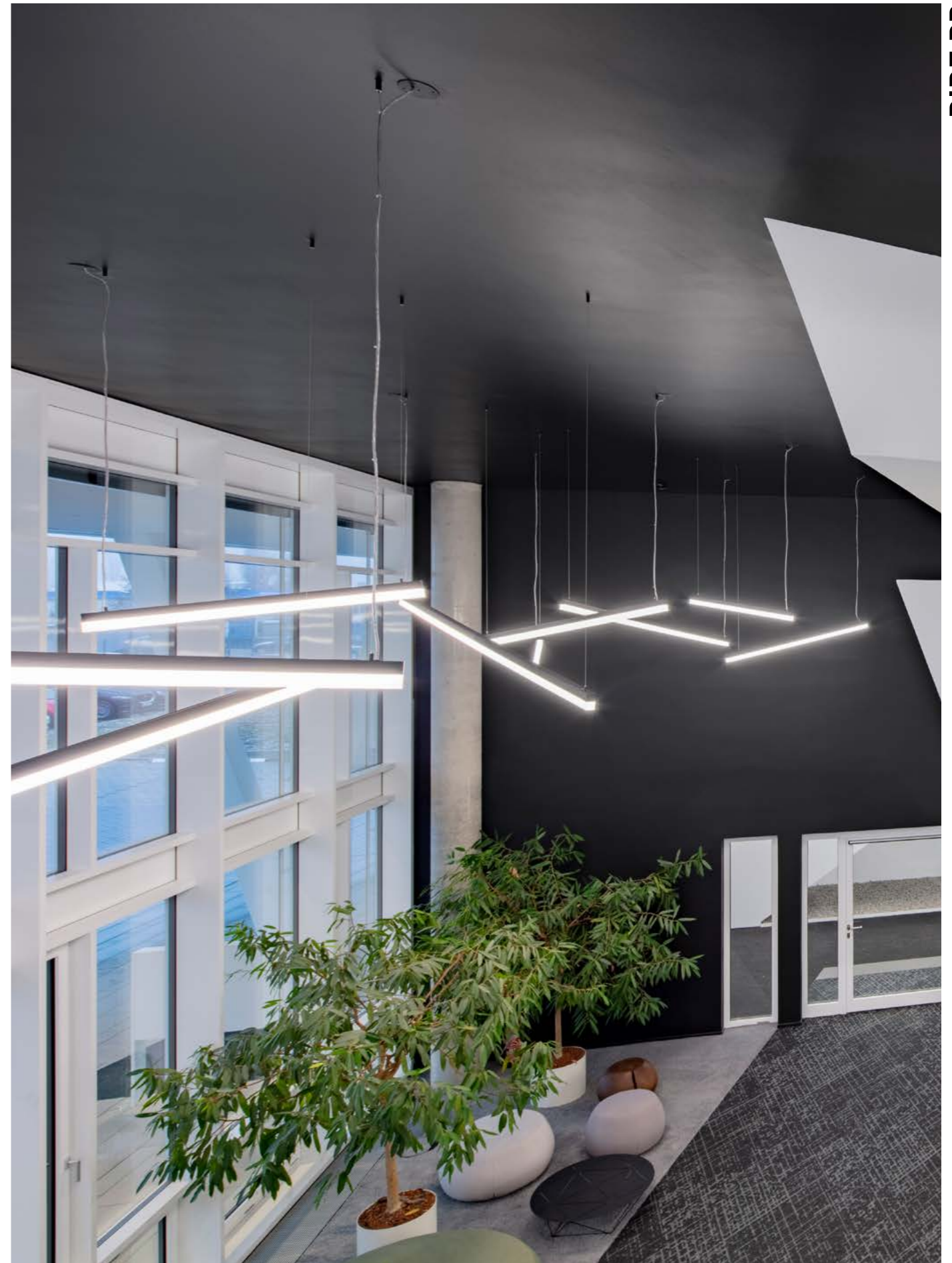

Technical data and energy efficiency





RIDE R OPAL OR MICROPRISMATIC DIFFUSER

220-240V AC 50/60Hz Design: INHOUSE

LED Einbauleuchte aus Aluminiumprofil · Oberfläche pulverbeschichtet oder eloxiert · Opale oder mikroprismatische Abdeckung · Schaltbar oder DALI dimm.
 LED recessed luminaire from aluminium profile · surface powder-coated or anodized · opal or microprismatic cover · switchable or DALI dimmable
 Lampada LED con profilo in alluminio · Superficie verniciata a polveri o anodizzata · Diffusore opale o microprismatico · On/off o dimmerabile DALI
 Profil en aluminium pressé de LED · surface lacquée en poudre ou anodisée · Diffuseur opale ou microprismatique · On/off ou dimmable DALI

SYS 10W	L: 581mm	LM	SYS 15W	L: 861mm	LM	SYS 19W	L: 1141mm	LM
577-01101COWWXXO		780 - 1050	577-01102COWWXXY		1170 - 1570	577-01103COWWXXY		1560 - 2100
not dimmable								

SYS 24W	L: 1421mm	LM	SYS 48W	L: 2821mm	LM	SYS 71W	L: 4221mm	LM
577-01104COWWXXY		1950 - 2620	577-01105COWWXXY		3910 - 5250	577-01106COWWXXY		5870 - 7870

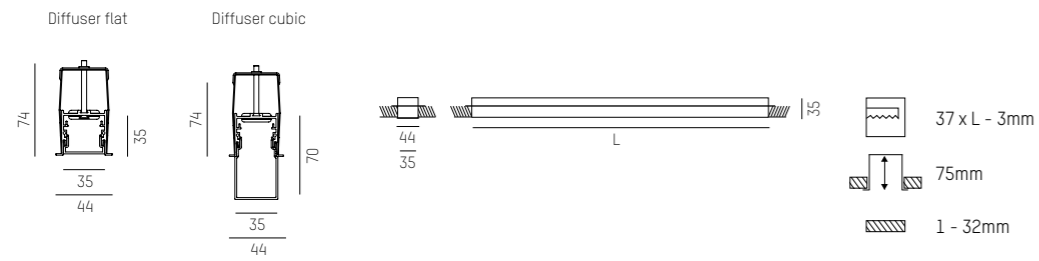

IP20



COMPLETE CODE	C = COVER	WW = LIGHT COLOUR	XX = COLOUR	Y = DIMMABLE
opal flat = 1	LED 2700K = 23 CRI>90	white = 05	black = 06	switchable = 0
opal cubic = 2	LED 3000K = 29 CRI>90	alu anodized = 08		DALI dimm. = d
microprismatic flat = 3	LED 4000K = 24 CRI>90			



Technical data and energy efficiency

Truckcenter Katzinger
 Altenfelden, Austria
 Leibez Interieur Design
 Photo: Stöbich





RIDE IP54 R

220-240V AC 50/60Hz Design: INHOUSE

OPAL DIFFUSER

LED Einbauleuchte aus Aluminiumprofil · Oberfläche pulverbeschichtet oder eloxiert · Opale Abdeckung · Schaltbar oder DALI dimmbar · IP54
 LED recessed luminaire from aluminium profile · surface powder-coated or anodized · opal cover · switchable or DALI dimmable · IP54
 Lampada LED con profilo in alluminio · Superficie verniciata a polveri o anodizzata · Diffusore opale · On/off o dimmerabile DALI · IP54
 Profil en aluminium pressé de LED · surface lacquée en poudre ou anodisée · Diffuseur opale · On/off ou dimmable DALI · IP54

SYS 10W	L: 606mm	LM	SYS 15W	L: 886mm	LM	SYS 19W	L: 1166mm	LM
577-01401COWWXXO		820 - 930	577-01402COWWXXY		1230 - 1400	577-01403COWWXXY		1650 - 1860
not dimmable								

SYS 24W	L: 1446mm	LM	SYS 48W	L: 2846mm	LM	SYS 71W	L: 4246mm	LM
577-01404COWWXXY		2060 - 2330	577-01405COWWXXY		4130 - 4670	577-01406COWWXXY		6190 - 7000

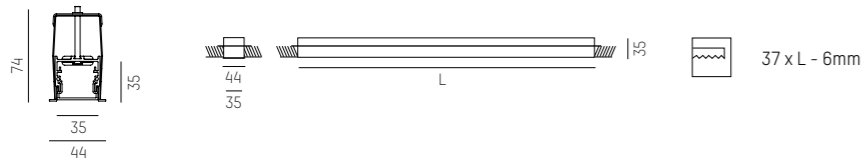

IP20 Ⓢ CE



COMPLETE CODE	C = COVER	WW = LIGHT COLOUR	XX = COLOUR	Y = DIMMABLE
opal flat = 1	W2 LED 2700K = 23 CRI>90	W white = 05	S switchable = 0	
	W3 LED 3000K = 29 CRI>90	black = 06	D DALI dimm. = d	
	W4 LED 4000K = 24 CRI>90	AE alu anodized = 08		



RIDE IP54 R

Private residence
 Austria
 Ostertag Architects ZT GmbH
 Photo: Florian Frey



RIDE IP 54 R



RIDE LENS R

220-240V AC 50/60Hz UGR<19 Design: INHOUSE

LED Einbauleuchte aus Aluminiumprofil · Oberfläche pulverbeschichtet oder eloxiert · zurückversetzte Linsen und Hochglanzraster · perfekte Entblendung
 LED recessed luminaire from aluminium profile · surface powder-coated or anodized · recessed lenses and high-gloss grid · perfect anti-clare
 Lampada LED con profilo in alluminio · Superficie verniciata a polveri o anodizzata · lente retrocessa con griglia nera lucida · anti-abbagliamento
 Profil en aluminium pressé de LED · surface lacquée en poudre ou anodisée · optique placée en fond combinée avec darklight · anti-éblouissement

LED 6W	L: 113mm	LM	LED 17W	L: 304mm	LM	LED 31W	L: 590mm	LM
634-002040RWWXX		440 - 550	634-002010RWWXX		1330 - 1650	634-002020RWWXX		2420 - 3000
500mA			500mA			900mA		

LED 47W	L: 878mm	LM	LED CONVERTER	mA	DIMM	FOR
634-002030RWWXX		3630 - 4510	24-122201	500	not dimmable	1 - 2 x RIDE 6W / 1 x RIDE 17W
1400mA			24-151403	500	DALI dimmable	1 - 2 x RIDE 6W / 1 x RIDE 17W
			24-122204	900	not dimmable	1 x RIDE 31W
			24-15141350	900	DALI dimmable	1 x RIDE 31W
			24-1222084	1400	not dimmable	1 x RIDE 47W
			24-123170	1400	DALI dimmable	1 x RIDE 47W

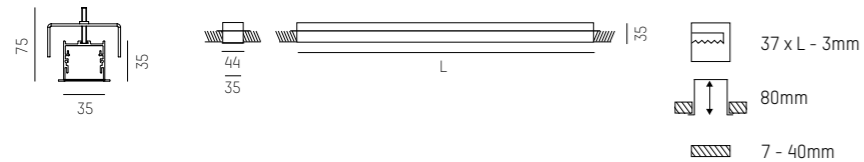

IP20 CE

COMPLETE CODE		
R = REFLECTOR	WW = LIGHT COLOUR	XX = COLOUR
☐ 15° = 1	W2 LED 2700K = 23 CRI>90	W white = 05
☐ 34 + 15° = 6	W3 LED 3000K = 29 CRI>90	S black = 06
☐ 45° = 3	W4 LED 4000K = 24 CRI>90	AE alu anodized = 08

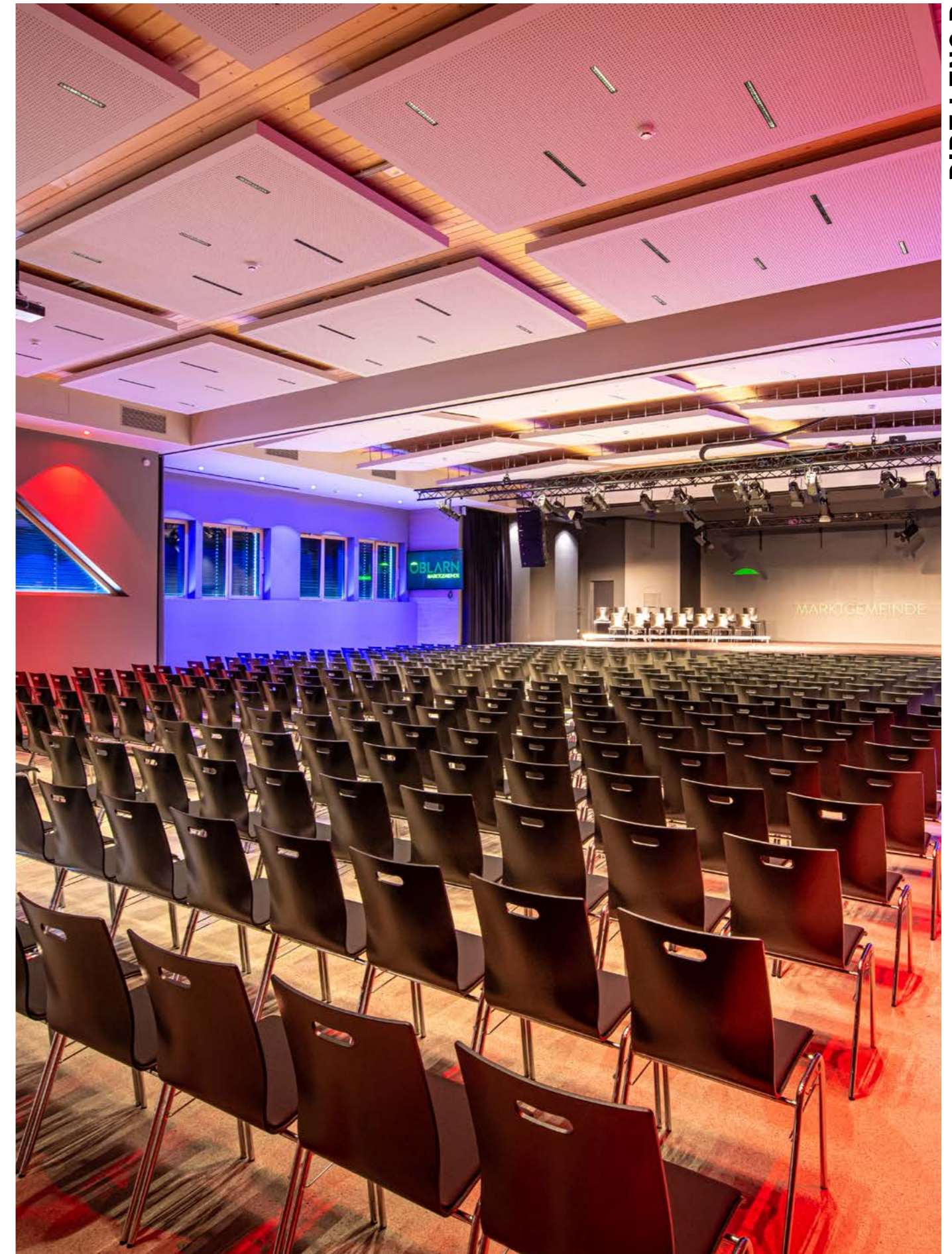

RIDE LENS R

Technical data and energy efficiency

ÖHA
 Liezen, Austria
 Photo: Christoph Huber



RIDE LENS R



RIDE LENS TURN R

220-240V AC 50/60Hz UGR<19 Design: INHOUSE

LED Einbauleuchte aus Aluminiumprofil · Oberfläche pulverbeschichtet · zurückversetzte Linsen und Hochglanzraster · perfekte Entblendung
 LED recessed luminaire from aluminium profile · surface powder-coated · recessed lenses and high-gloss grid · perfect anti-clare
 Lampada LED con profilo in alluminio · Superficie verniciata a polveri · lente retrocessa con griglia nera lucida · anti-abbagliamento
 Profil en aluminium pressé de LED · surface lacquée en poudre · optique placée en fond combinée avec darklight · anti-éblouissement

LED 17W	L: 365mm	LM
634-007010RWWXX		1330 - 1650
500mA		

LED CONVERTER	mA	DIMM	FOR
24-122201	500	not dimmable	1 x RIDE 17W
24-151403	500	DALI dimmable	1 x RIDE 17W

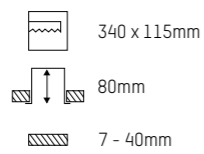
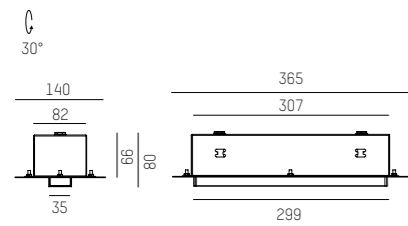

IP20 Ⓢ CE



COMPLETE CODE		
R = REFLECTOR	WW = LIGHT COLOUR	XX = COLOUR
☐ 15° = 1	☐ W2 LED 2700K = 23 CRI>90	☐ W white = 05
☐ 34 + 15° = 6	☐ W3 LED 3000K = 29 CRI>90	☐ S black = 06
☐ 45° = 3	☐ W4 LED 4000K = 24 CRI>90	



RIDE LENS TURN R

Technical data and energy efficiency



RIDE LENS TURN R

Sport Herzog
 Neukirchen, Austria
 Photo: Joachim Rauch

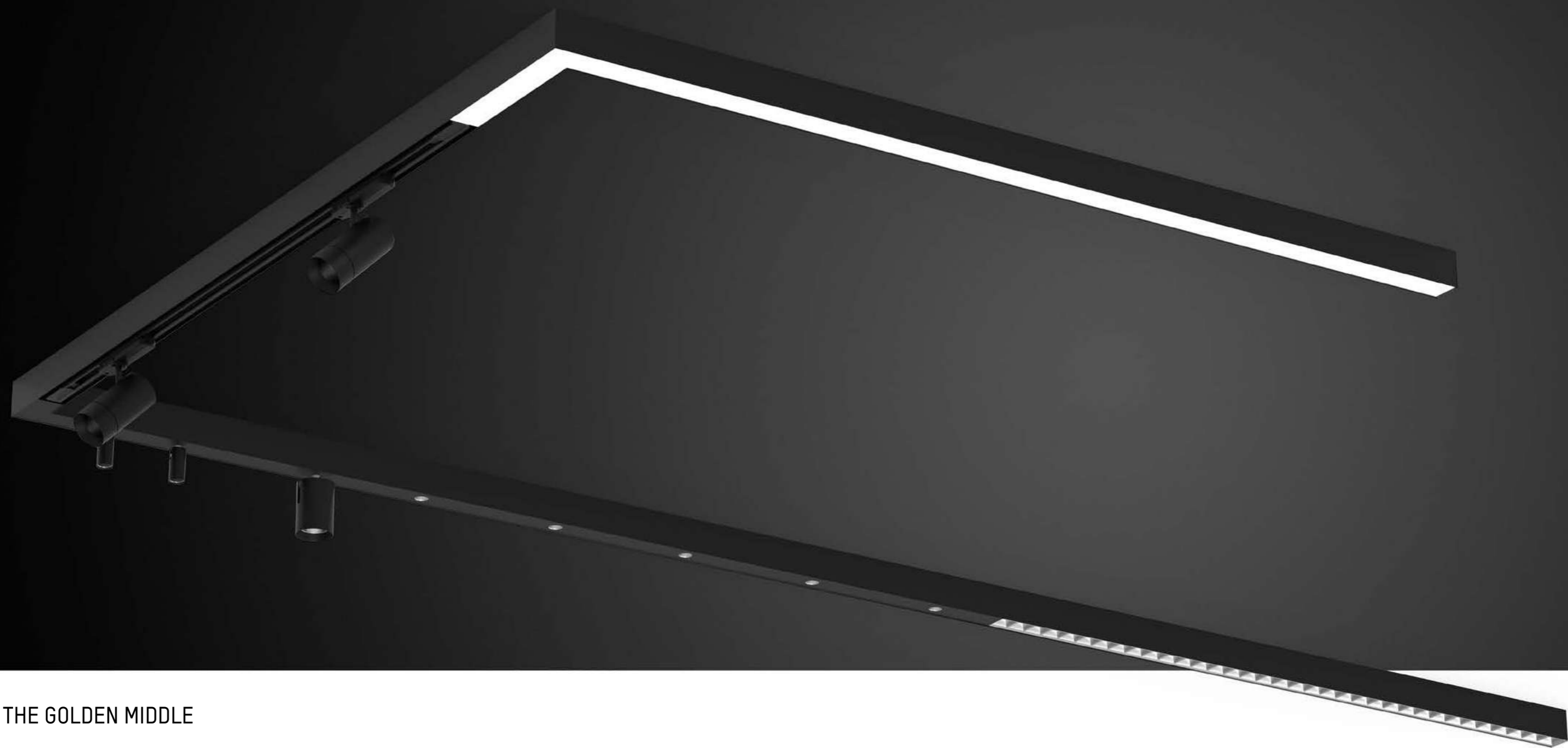

THE GOLDEN MIDDLE

LOG 50 bietet die perfekte Ergänzung zu den erfolgreichen Produktserien RIDE und LOG 2.1. Die Dimensionierung des Systems liegt genau in der Mitte, wodurch alle Vorteile der beiden bestehenden Linearsysteme, wie die einfache Montage und das reduzierte Design, in einer Leuchtenfamilie vereint werden konnten. Lineare Lichtlösungen zählen schon lange zum fixen Bestandteil moderner Architekturkonzepte. LOG 50 kombiniert dabei hohen Designanspruch mit perfekter Lichtleistung. LOG 50 Pendel-, Aufbau- und Einbauversionen sind neben Einzeleuchten auch als Systemvariante konfigurierbar. Durch verschiedenste Systemelemente lassen sich markante Statements setzen.

LOG 50 offers the perfect complement to the successful RIDE and LOG 2.1 product series. The dimensioning of the system is exactly in the middle, which made it possible to combine all the advantages of the two existing linear systems, such as easy mounting and reduced design in one luminaire family. Linear lighting solutions have long been an integral part of modern architectural concepts. LOG 50 combines high design standards with perfect lighting performance. LOG 50 pendant, surface-mounted and recessed versions can be configured not only as individual luminaires but also as system versions. Various system elements can be used to make striking statements.

Design: INHOUSE

LOG 50

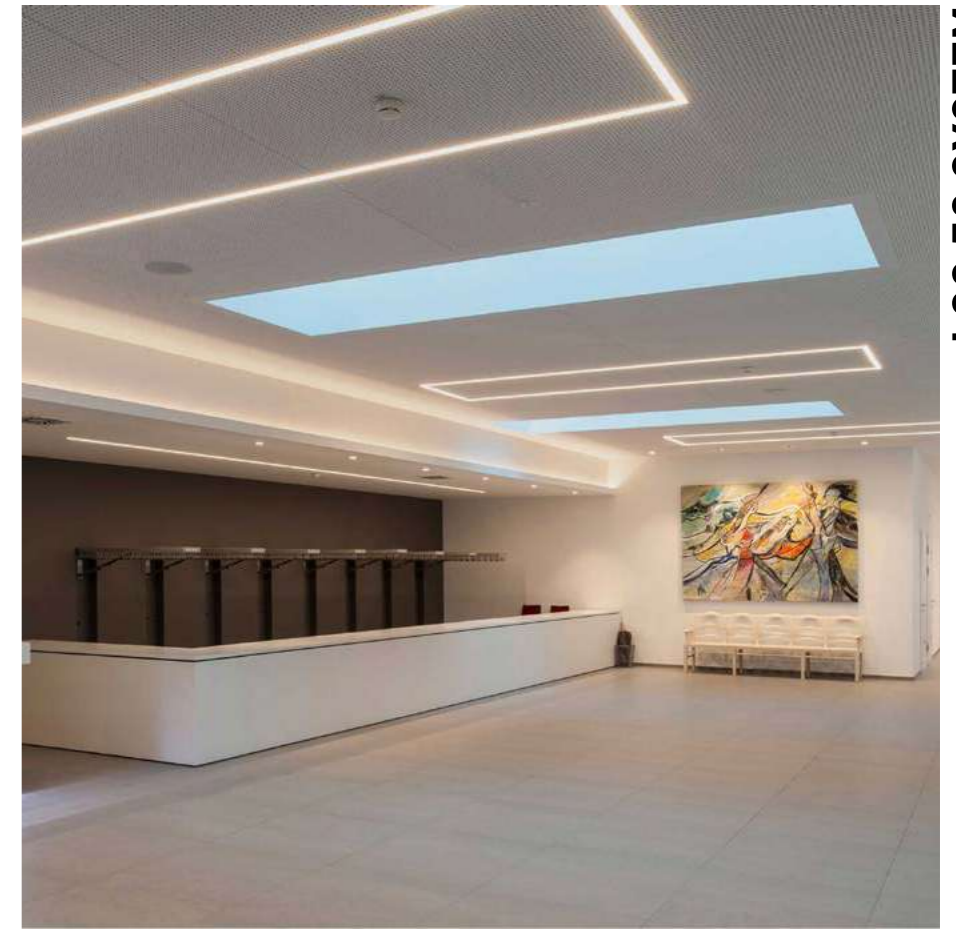
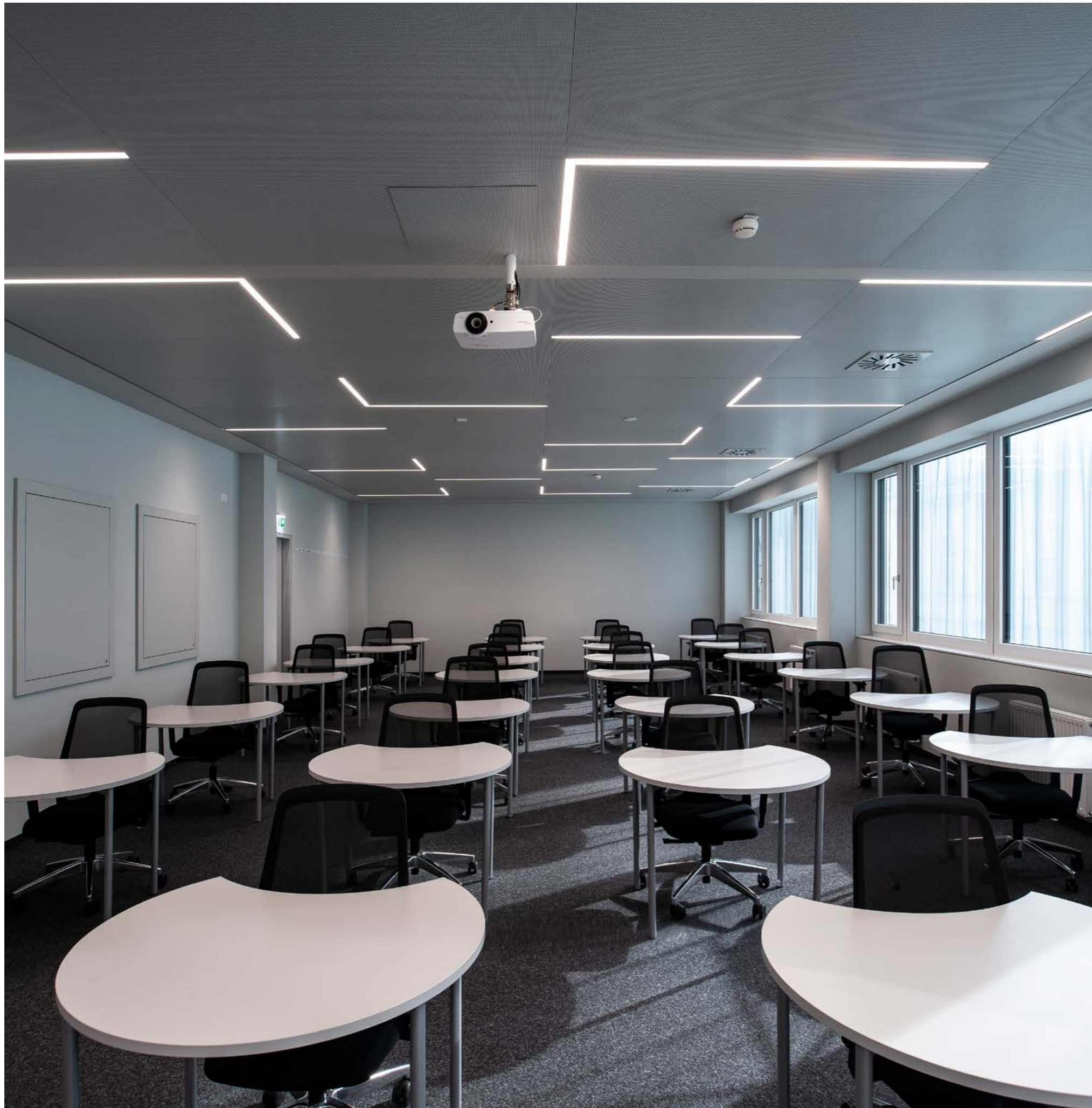

Stadtheater
Bad Hall, Austria
Photo: Joachim Rauch

BFI
Linz, Austria
Photo: Joachim Rauch



Molto Luce
Munich, Germany
Photo: Joachim Rauch

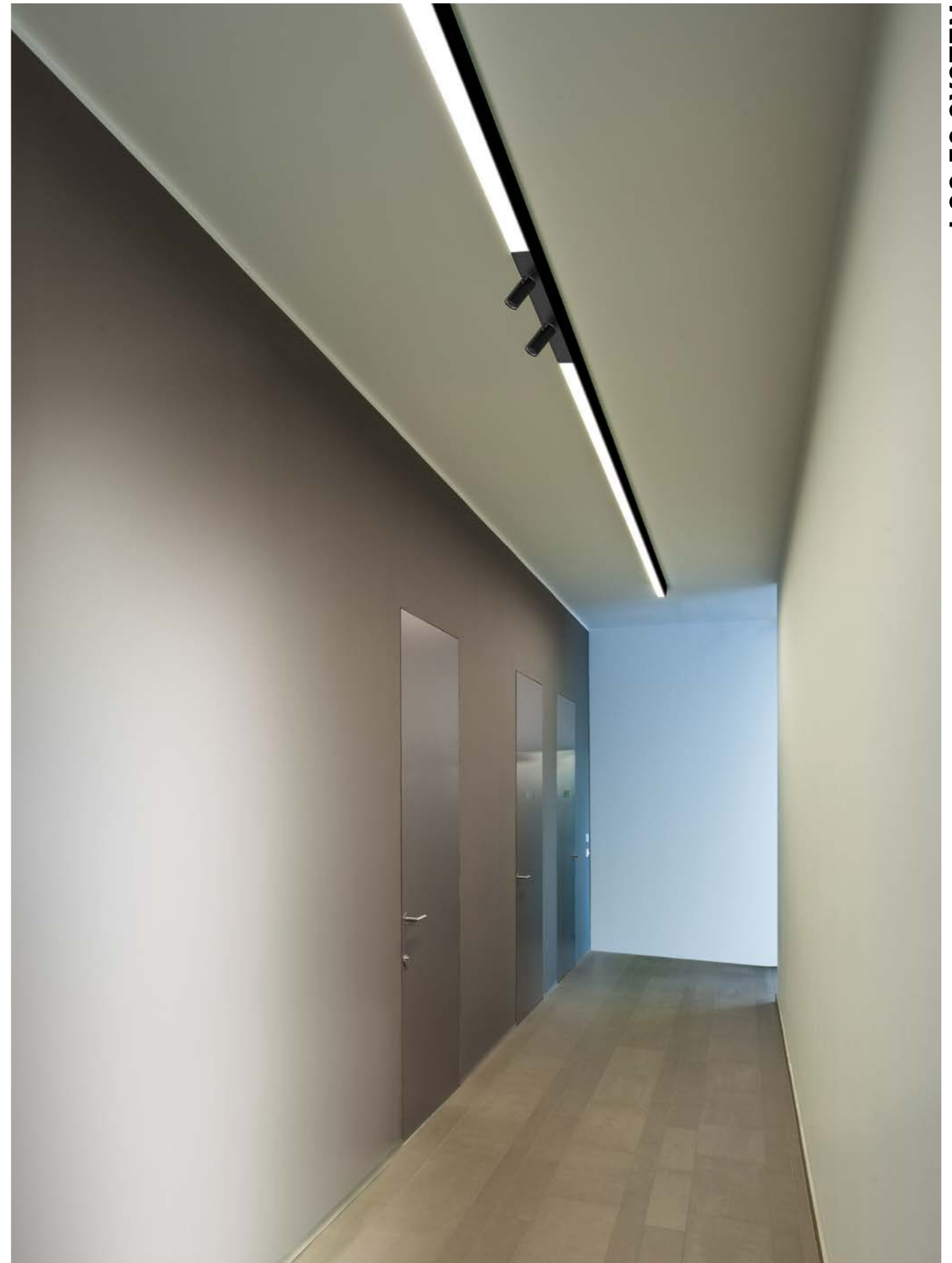

ETM
Haag, Austria
Photo: Joachim Rauch



System versions

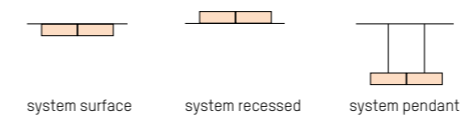

Profile

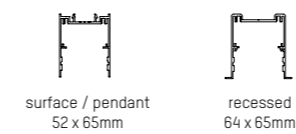

Form



Core Colours

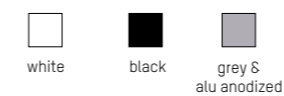

Creative Colours

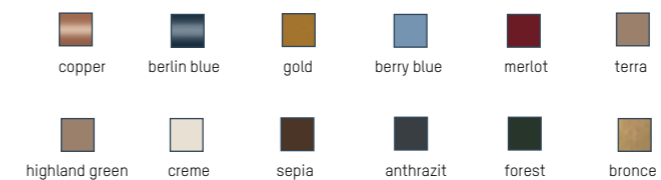

Optics & Cover

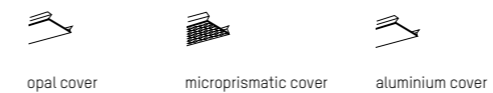

System inserts



Light beam

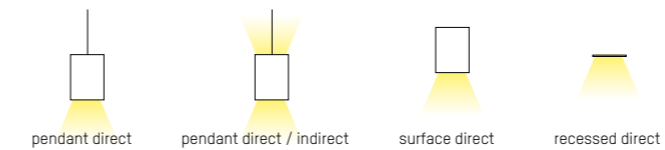

LED Colours



Design: INHOUSE

Information LOG 50



Configure LOG 50 SYSTEM





MySpace 192
Großkirchen, Austria
A. Kramm / M. Seibald
Photo: Joachim Rauch

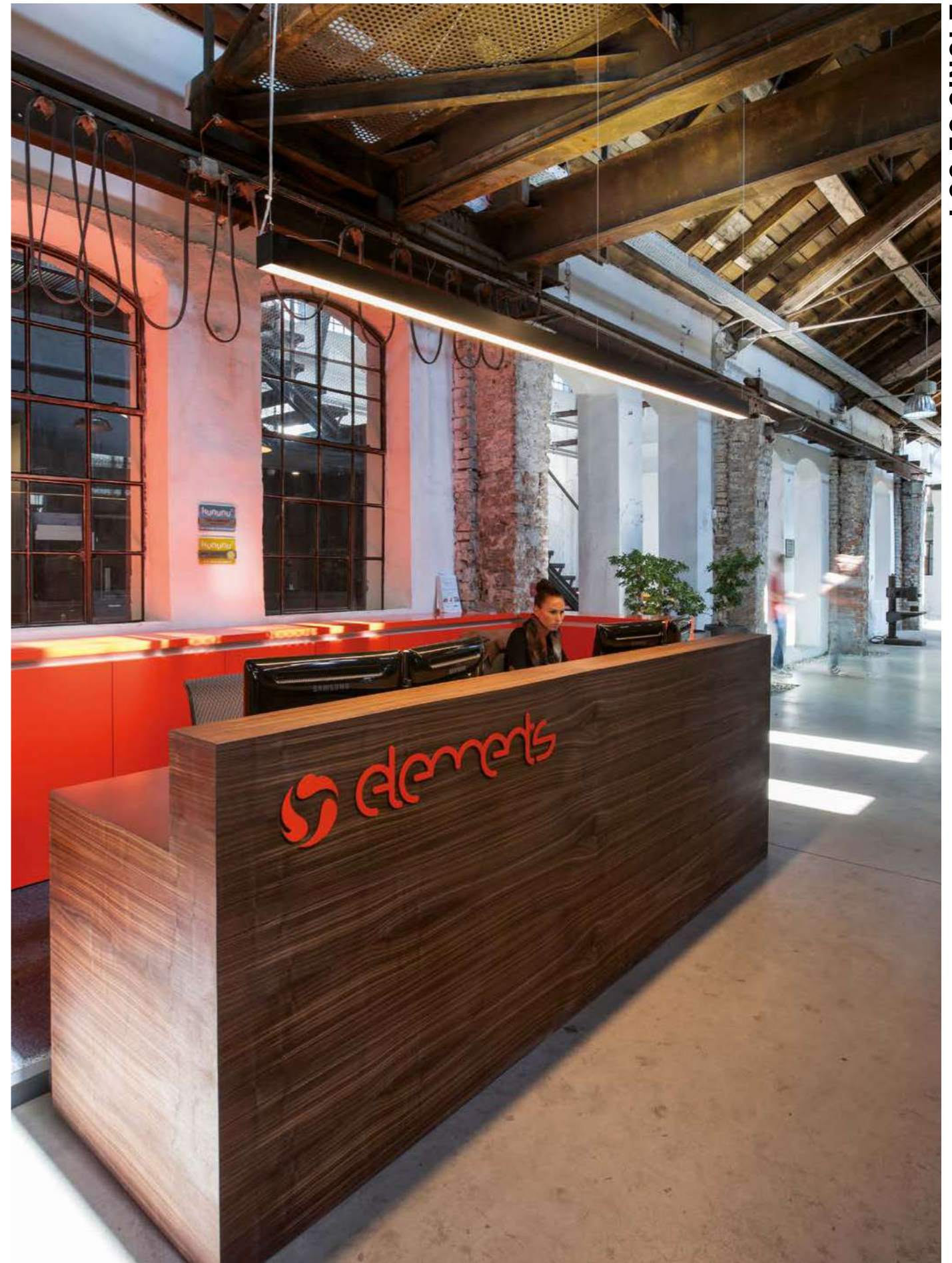

Elements
Gusswerk Salzburg, Austria
Photo: Joachim Rauch



BFI
Linz, Austria
Photo: Joachim Rauch

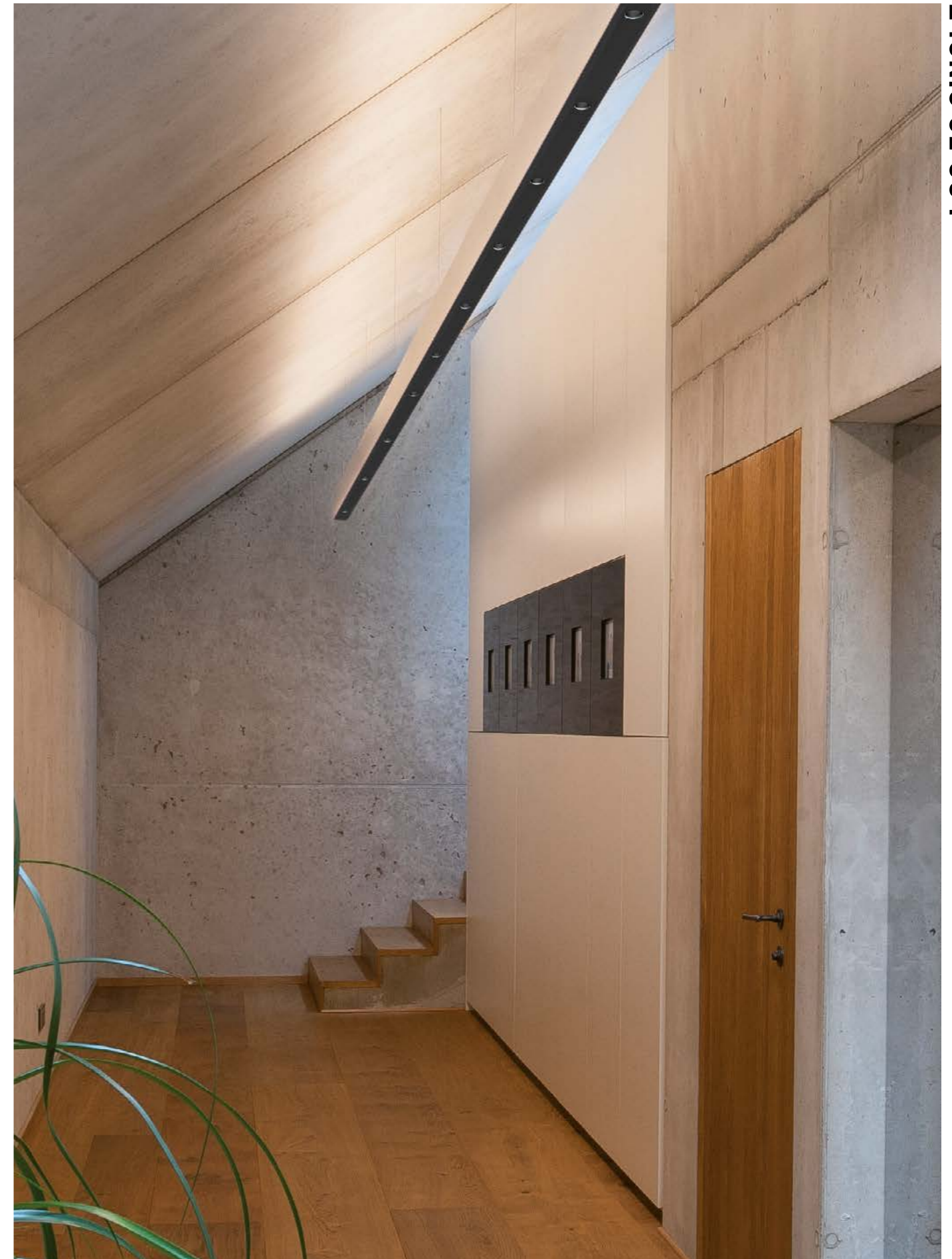

Private residence
Wels, Austria
Photo: Joachim Rauch

Private residence
Wels, Austria
Photo: Joachim Rauch

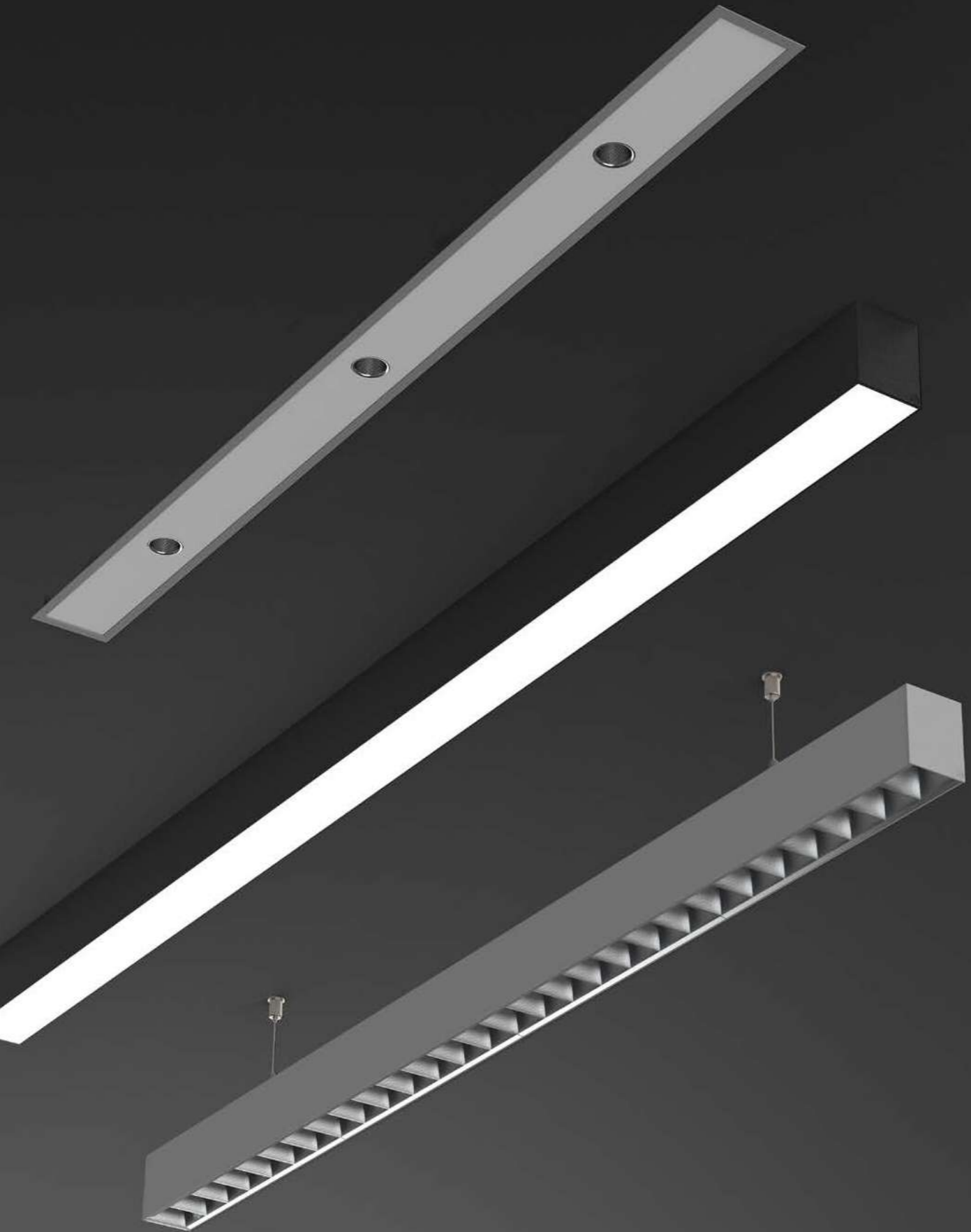

Single versions



Profile

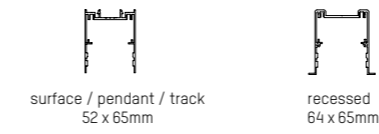

Form

L 846mm LM: 800 - 2570	L 1126mm LM: 1000 - 3420	L 1407mm LM: 1250 - 4280	L 1687mm LM: 1600 - 5130	L 2248mm LM: 2000 - 6840	L 2529mm LM: 2400 - 7700	L 2809mm LM: 2500 - 8560	L 3371mm LM: 3000 - 10260	L 4212mm LM: 3750 - 12840
---------------------------	-----------------------------	-----------------------------	-----------------------------	-----------------------------	-----------------------------	-----------------------------	------------------------------	------------------------------

Core Colours

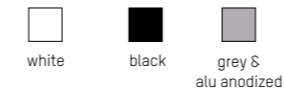

Creative Colours

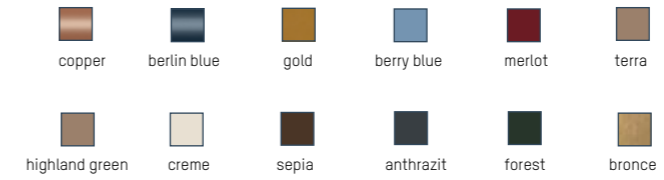

Versions

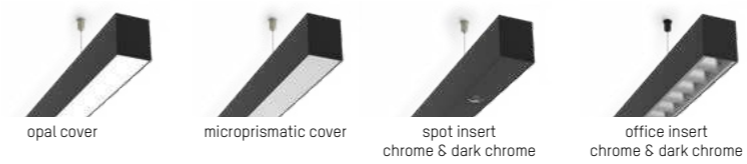

Light beam

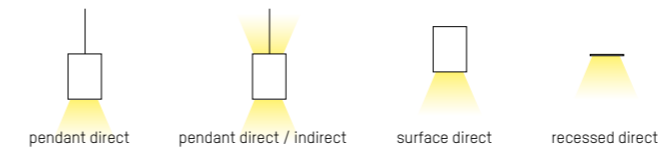

LED Colours



Design: INHOUSE

Information LOG 50



Configurate LOG 50 SINGLE



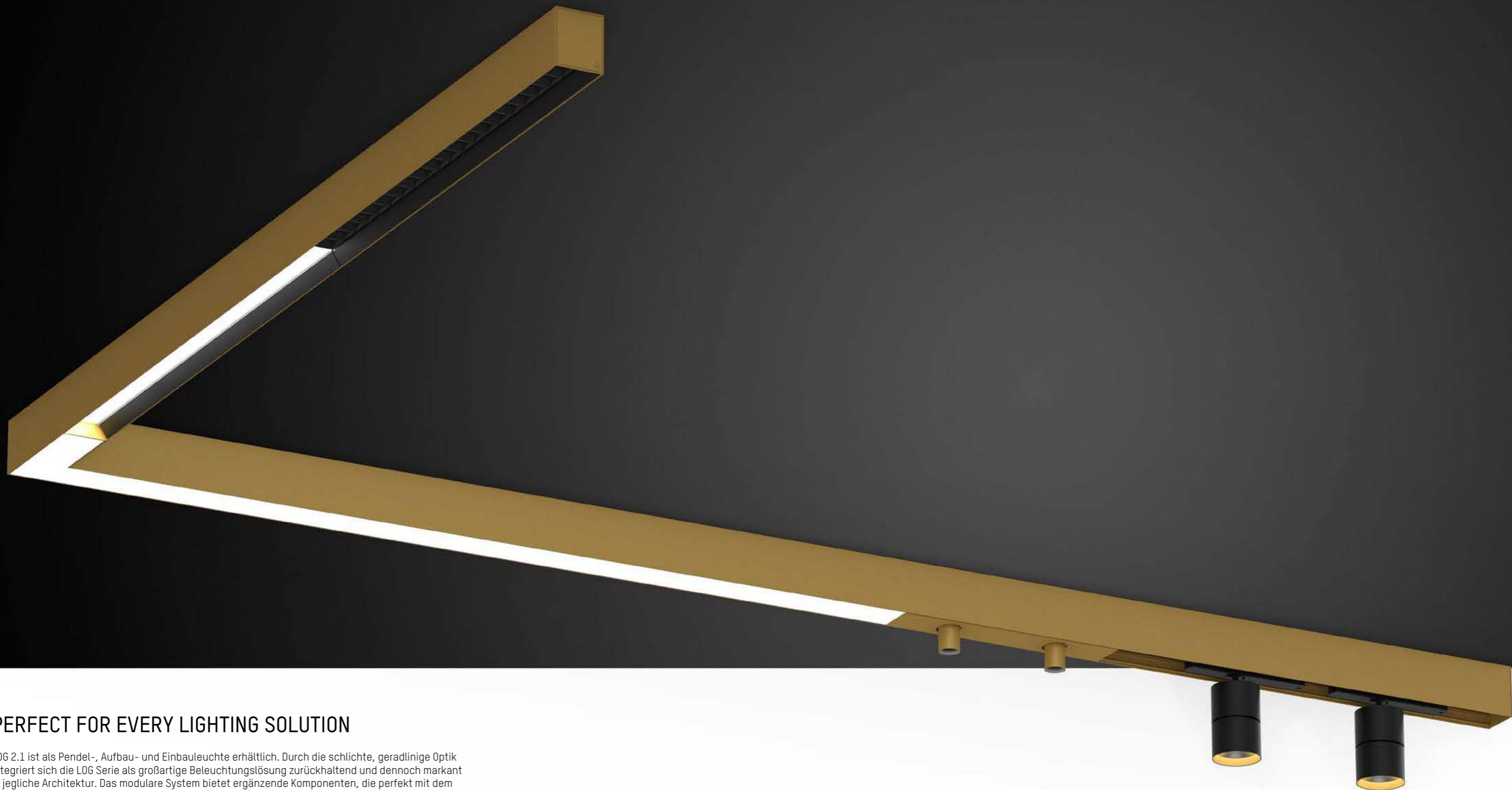

PERFECT FOR EVERY LIGHTING SOLUTION

LOG 2.1 ist als Pendel-, Aufbau- und Einbauleuchte erhältlich. Durch die schlichte, geradlinige Optik integriert sich die LOG Serie als großartige Beleuchtungslösung zurückhaltend und dennoch markant in jegliche Architektur. Das modulare System bietet ergänzende Komponenten, die perfekt mit dem Profil kombinierbar sind. Die Lichteinsätze mit opaler oder mikroprismatischer Abdeckung sowie die neuen BINA Einsätze welche sowohl UGR<19 als auch Ballwurfsicher sind eignen sich perfekt als Grundbeleuchtung. Für das LOG OUT 2.1, LOG IN 2.1 & LOG IN TRIMMLESS 2.1 System können der Trigga Einsatz sowie der Strahler MOVA als zusätzliches Beleuchtungselement verwendet werden.

LOG 2.1 is available as pendant, surface-mounted and recessed luminaires. Due to its simple, straightforward look, the LOG series can be integrated discretely, yet distinctively into any style of architecture as a great lighting solution. The modular system offers additional components which can be perfectly combined with the profile. The lighting inserts with opal or microprismatic covers as well as the new BINA inserts which are available as UGR<19 and as ball-proof version, are just perfect as basic lighting. The Trigga insert and the MOVA spotlight can be used as additional lighting elements for the LOG OUT 2.1, LOG IN 2.1 & LOG IN TRIMMLESS 2.1 system.

Design: INHOUSE

LOG 2.1

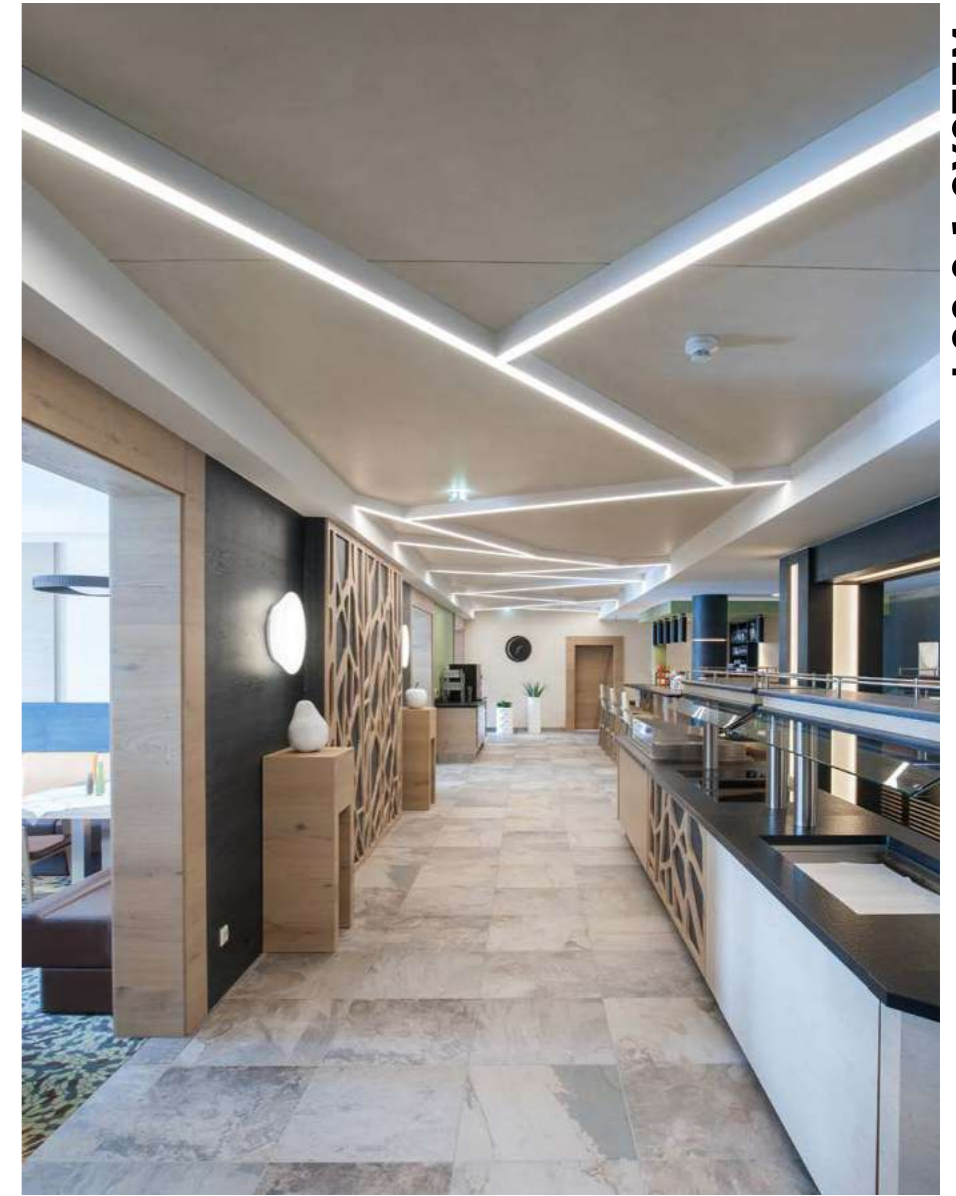
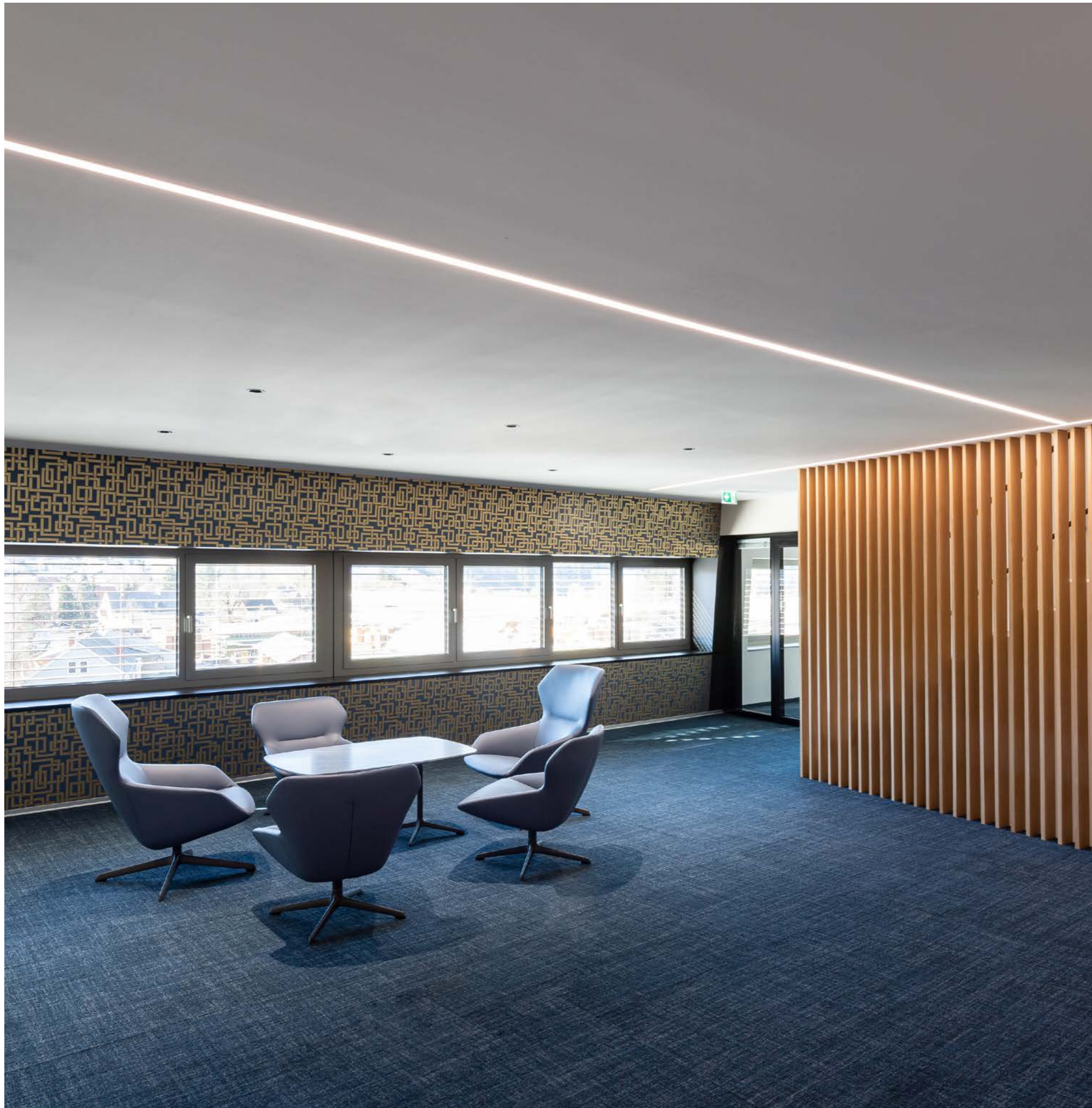

Hotel Aigo
Aigen, Austria
Photo: Joachim Rauch

IBS Austria GmbH
Teufenbach, Austria
Photo: Joachim Rauch



Mehler & Hamberger
Traunstein, Germany
Photo: Joachim Rauch

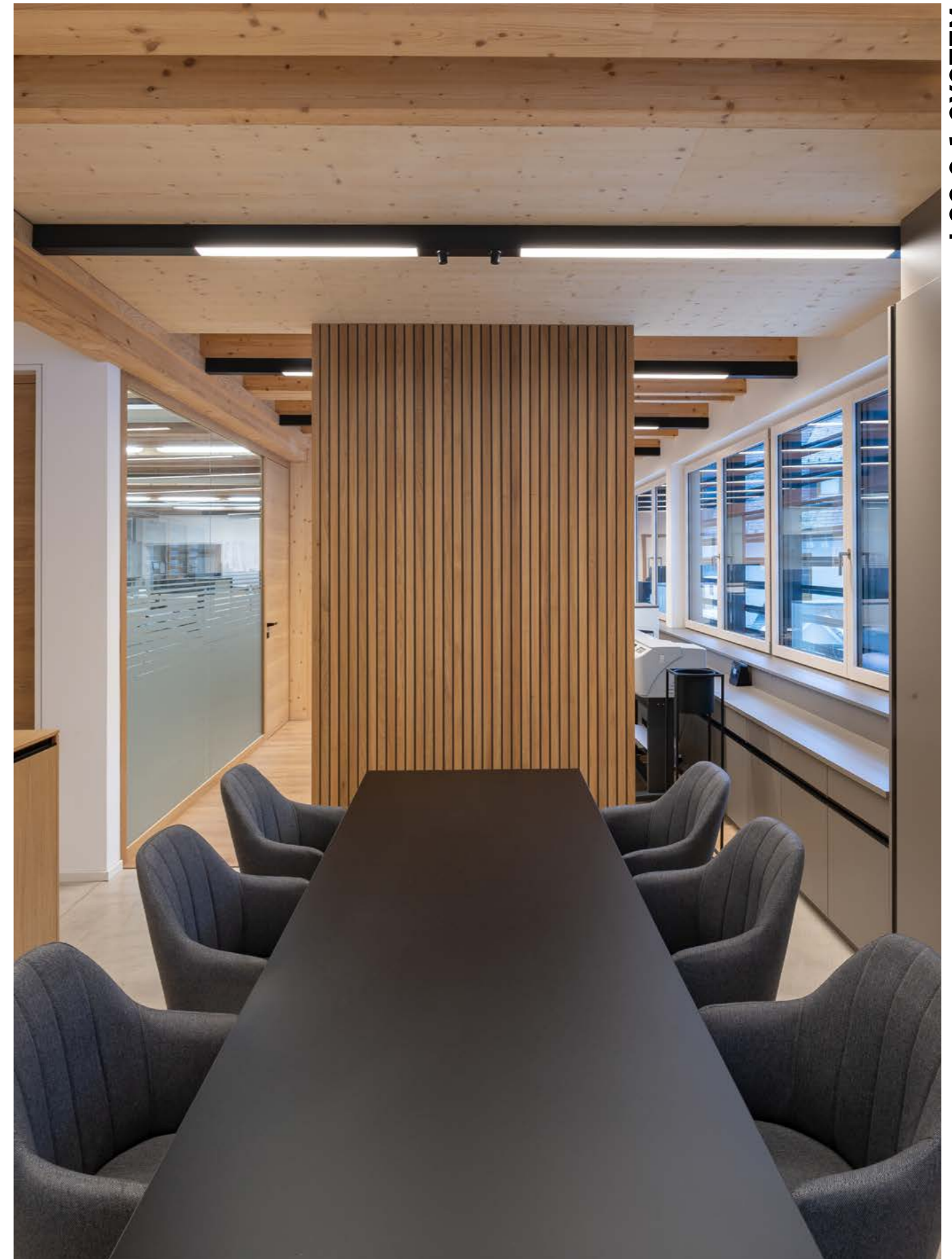

Tischlerei Berger
Ratten, Austria
Photo: Joachim Rauch



System versions

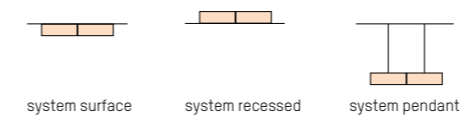

Profile 76 x 90mm

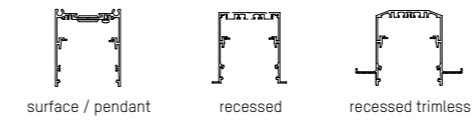

Form



Core Colours

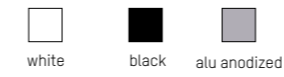

Creative Colours

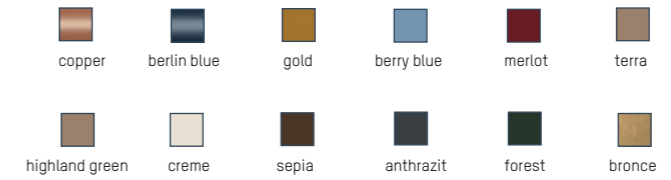

Optics & Cover

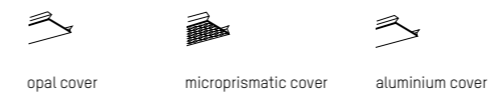

System inserts



Light beam

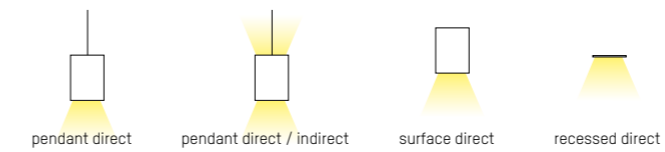

LED Colours



Design: INHOUSE

Configurate LOG 2.1 SYSTEM



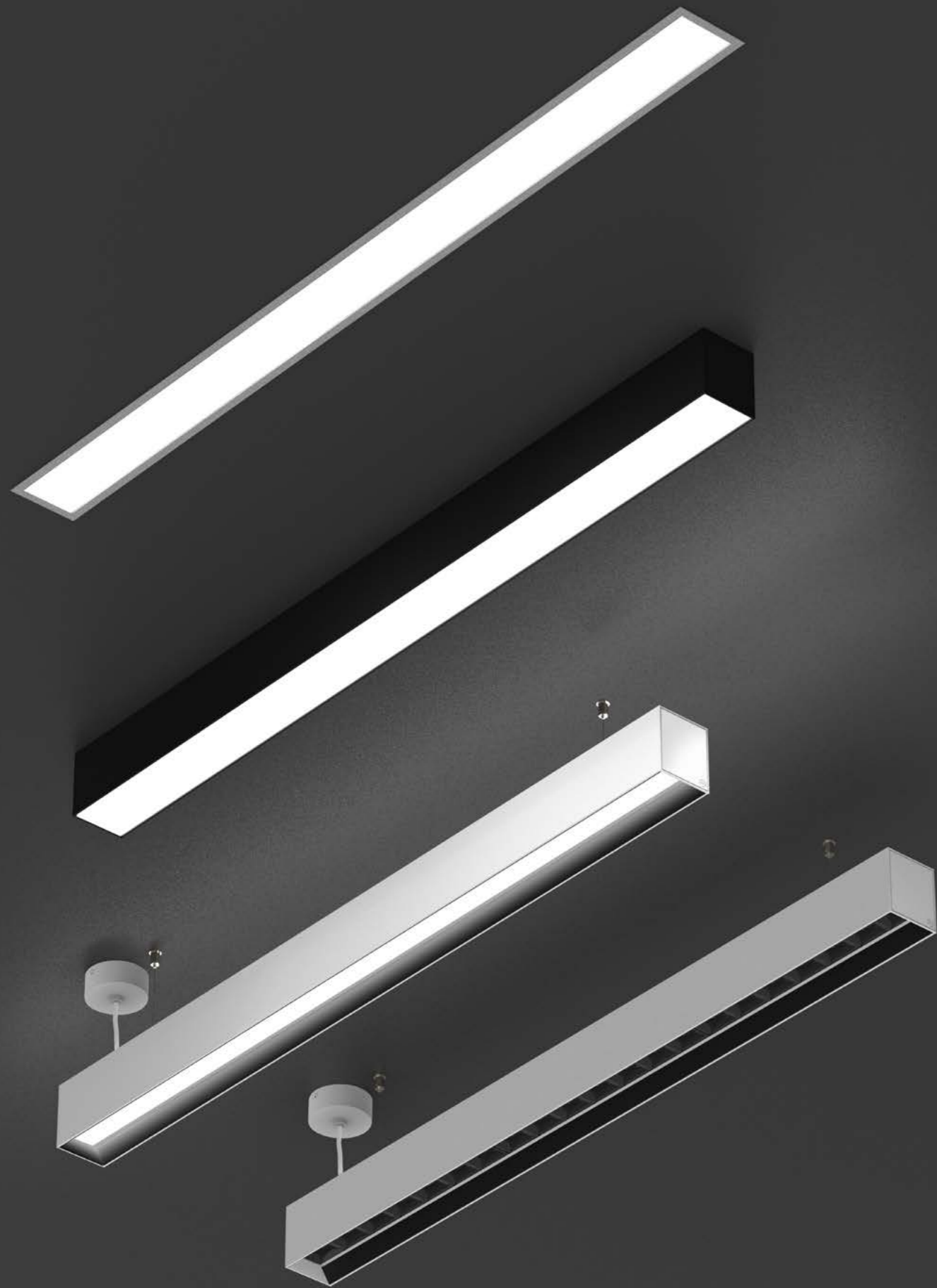

Single versions

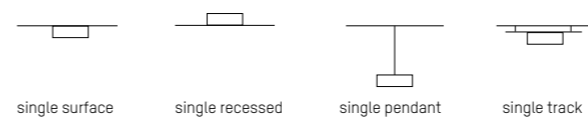

single surface single recessed single pendant single track

Profile

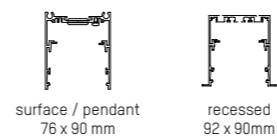

surface / pendant
76 x 90 mm recessed
92 x 90mm

Form



linear

Core Colours



white black grey & alu anodized

Creative Colours

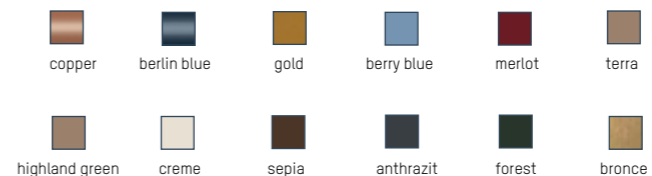

copper berlin blue gold berry blue merlot terra
highland green creme sepia anthrazit forest bronze

Versions



opal cover microprismatic cover bina insert bina office insert bina lens insert

Light beam

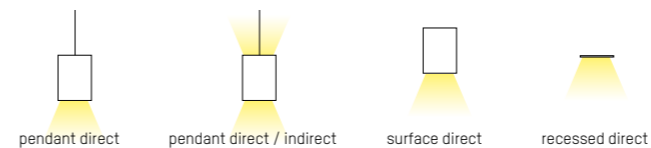

pendant direct pendant direct / indirect surface direct recessed direct

LED Colours



2700K 3000K 4000K Tunable white

Design: INHOUSE

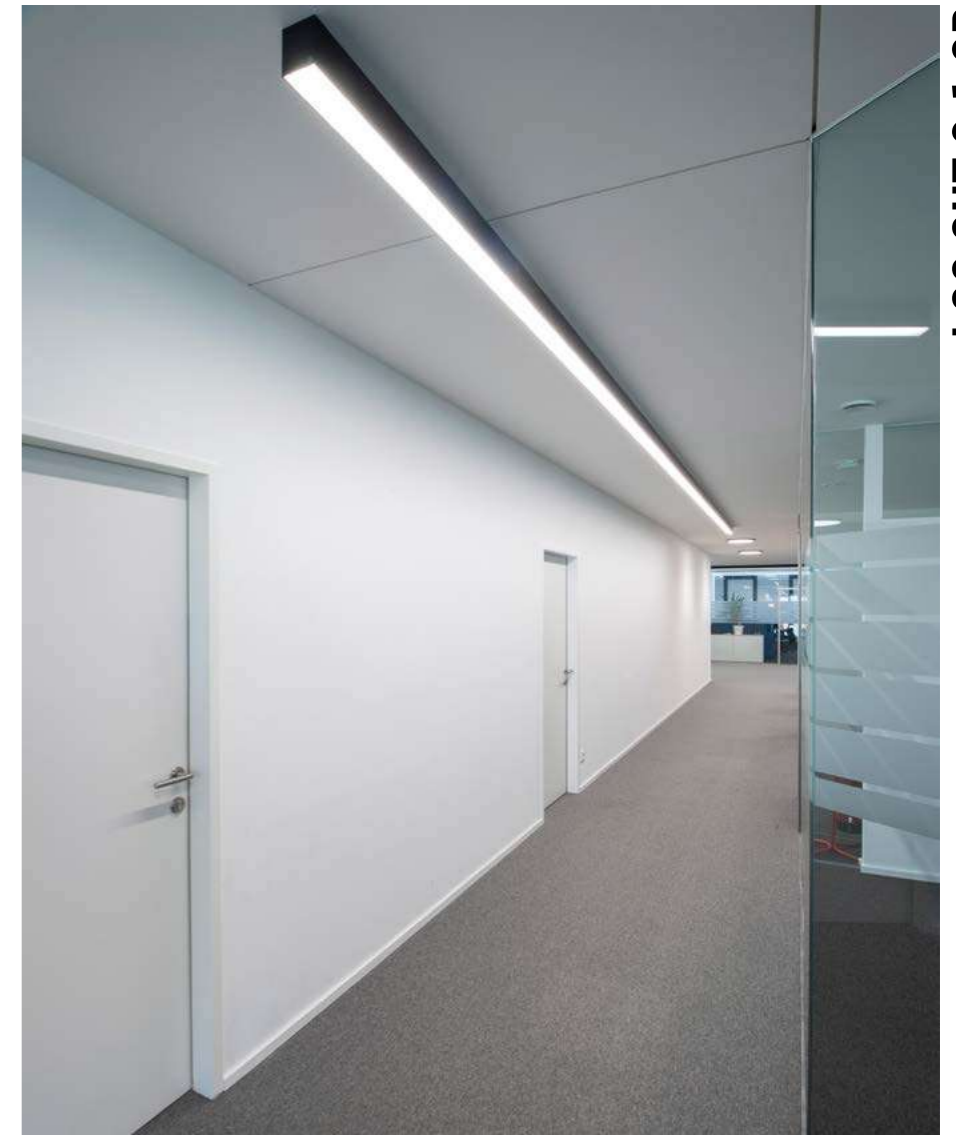

Dormakaba
Seekirchen, Austria
Photo: Joachim Rauch

Dentist Dr. Hirsch
Tiefenbach, Germany
Photo: Joachim Rauch



OPAL COVER



MICROPRISMATIC COVER

LOG OUT 2.1 SD MID OUTPUT / HIGH OUTPUT OPAL / MICROPRISMATIC DIFFUSER
220-240V AC 50/60Hz Design: INHOUSE

LED Aufbauleuchte aus Aluminiumprofil · Oberfläche pulverbeschichtet oder eloxiert · Abdeckung mit Mikroprismenoptik oder Opaldiffusor
LED surface luminaire from aluminium profile · surface powder-coated or anodized · opal or microprismatic diffuser
Lampada LED a plafone con profilo in alluminio · superficie verniciata a polveri o anodizzata · diffusore opale o microprismatico
Plafonnier LED en profilé d'aluminium · surface lacquée en poudre ou anodisée · diffuseur opal ou en microprisme

SYS 12W / 24W L: 850mm LM 728-10103LCWWXXY 1450 - 2950	SYS 16W / 31W L: 1131mm LM 728-10104LCWWXXY 1940 - 3930	SYS 20W / 40W L: 1411mm LM 728-10105LCWWXXY 2430 - 4920
SYS 32W / 62W L: 2255mm LM 728-10106LCWWXXY 3880 - 7860	SYS 40W / 80W L: 2816mm LM 728-10107LCWWXXY 4860 - 9840	SYS 48W / 93W L: 3379mm LM 728-10108LCWWXXY 5820 - 11790
SYS 60W / 120W L: 4220mm LM 728-10109LCWWXXY 7290 - 14760		

Technical data and energy efficiency



LOG OUT 2.1 SD

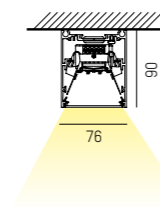
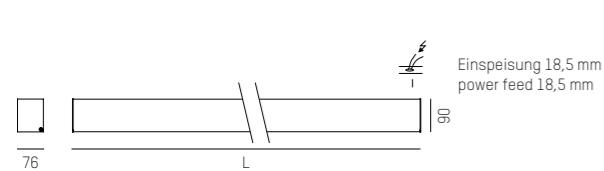

IP20 CE



COMPLETE CODE				
L = LIGHT INSERT	C = COVER	WW = LIGHT COLOUR	XX = COLOUR	Y = DIMMABLE
MO MID OUTPUT = 1 HO HIGH OUTPUT = 3	opal = 1 microprismatic foil = 8 UGR<19 (only MID OUTPUT)	W2 LED 2700K = 13 CRI>80 W3 LED 3000K = 19 CRI>80 W4 LED 4000K = 14 CRI>80	W white = 50 S black = 60 AE alu anodized = 80	Ⓢ switchable = 0 Ⓣ DALI dimm. = d



LENS INSERT

LOG OUT 2.1 BINA LENS SD BINA LENS INSERT
220-240V AC 50/60Hz UGR<19 Design: INHOUSE

LED Aufbauleuchte aus Aluminiumprofil · Oberfläche pulverbeschichtet oder eloxiert · schwarzer Lichteinsatz mit Linseneinsatz
LED surface luminaire from aluminium profile · surface powder-coated or anodized · black light insert with lens insert
Lampada LED a plafone con profilo in alluminio · superficie verniciata a polveri o anodizzata · inserto a luce nera con lente
Plafonnier LED en profilé d'aluminium · surface lacquée en poudre ou anodisée · insert de lumière noire avec lentille

SYS 43W L: 1131mm LM 728-1070436WWXXY 4370 - 4650	SYS 86W L: 2255mm LM 728-1070636WWXXY 8740 - 9300	SYS 129W L: 3379mm LM 728-1070836WWXXY 13110 - 13950
--	--	---

Technical data and energy efficiency



LOG OUT 2.1 BINA LENS SD

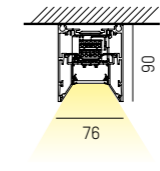
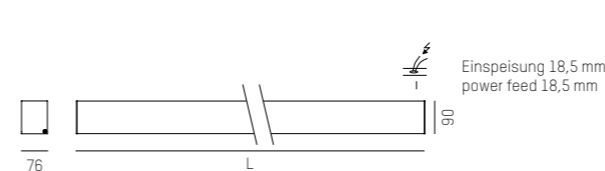

IP20 CE



COMPLETE CODE		
WW = LIGHT COLOUR	XX = COLOUR	Y = DIMMABLE
W2 LED 2700K = 13 CRI>80 W3 LED 3000K = 19 CRI>80 W4 LED 4000K = 14 CRI>80	W white = 56 S black = 66 AE alu anodized = 86	Ⓢ switchable = 0 Ⓣ DALI dimm. = d

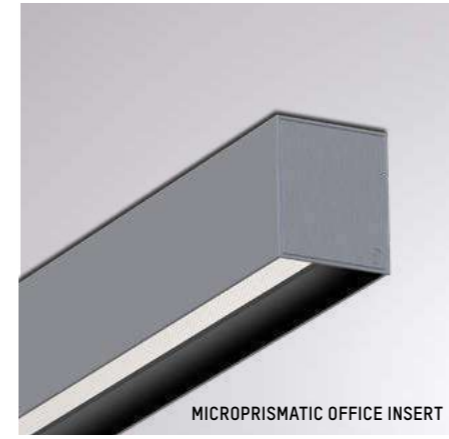
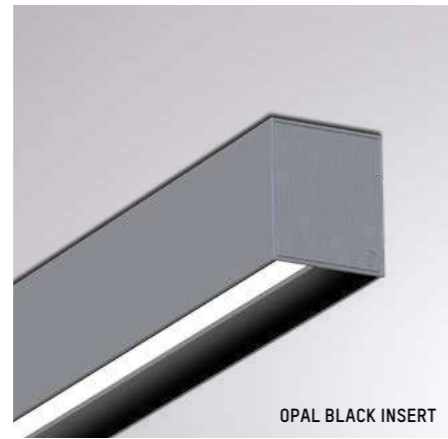
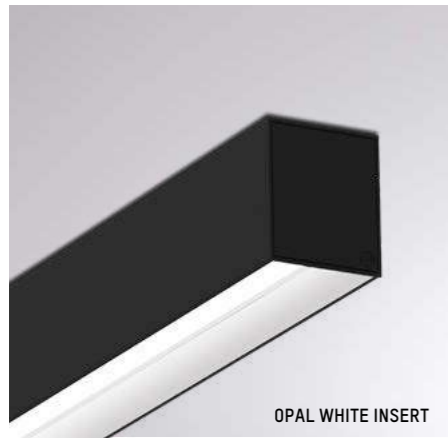

LOG OUT 2.1 BINA SD MID OUTPUT / HIGH OUTPUT BINA OPAL INSERT
 220-240V AC 50/60Hz Design: INHOUSE

LED Aufbauleuchte aus Aluminiumprofil · Oberfläche pulverbeschichtet oder eloxiert · Lichteinsätze schwarz oder weiß mit Opaldiffusor
 LED surface luminaire from aluminium profile · surface powder-coated or anodized · light inserts black or white with opal diffuser
 Lampada LED a plafone con profilo in alluminio · superficie verniciata a polveri o anodizzata · inserti luminosi neri o bianchi con diffusore opale
 Plafonnier LED en profilé d'aluminium · surface lacquée en poudre ou anodisée · inserts lumineux noirs ou blancs avec diffuseur opal

SYS 12W / 24W L: 850mm LM 728-10203L1WWXXY 1130 - 3090	SYS 16W / 31W L: 1131mm LM 728-10204L1WWXXY 1510 - 4120	SYS 20W / 40W L: 1411mm LM 728-10205L1WWXXY 1890 - 5150
SYS 32W / 62W L: 2255mm LM 728-10206L1WWXXY 3020 - 8240	SYS 40W / 80W L: 2816mm LM 728-10207L1WWXXY 3780 - 10300	SYS 48W / 93W L: 3379mm LM 728-10208L1WWXXY 4530 - 12360
SYS 60W / 120W L: 4220mm LM 728-10209L1WWXXY 5670 - 15450		

Technical data and energy efficiency



LOG OUT 2.1 BINA SD

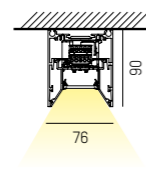
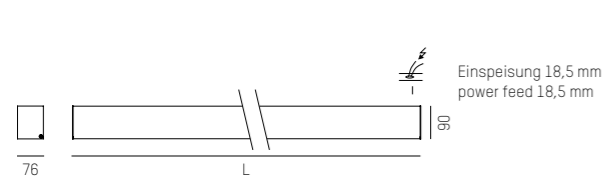

IP20 CE

COMPLETE CODE				
L = LIGHT INSERT	WW = LIGHT COLOUR	X = COLOUR PROFILE	X = COLOUR LIGHT INSERT	Y = DIMMABLE
MO MID OUTPUT = 1	W2 LED 2700K = 13 CRI>80	W white = 5	W white = 5	S switchable = 0
HO HIGH OUTPUT = 3	W3 LED 3000K = 19 CRI>80	S black = 6	S black = 6	D DALI dimm. = d
	W4 LED 4000K = 14 CRI>80	AE alu anodized = 8		

LOG OUT 2.1 BINA OFFICE SD BINA OFFICE INSERT
 220-240V AC 50/60Hz **UGR<19** Design: INHOUSE

LED Aufbauleuchte aus Aluminiumprofil · Oberfläche pulverbeschichtet oder eloxiert · schwarzer Lichteinsatz mit Mikroprismenoptik
 LED surface luminaire from aluminium profile · surface powder-coated or anodized · black light insert with microprismatic diffuser
 Lampada LED a plafone con profilo in alluminio · superficie verniciata a polveri o anodizzata · inserto a luce nera con ottica a microprismi
 Plafonnier LED en profilé d'aluminium · surface lacquée en poudre ou anodisée · insert de lumière noire avec optique à microprisme

SYS 26W L: 850mm LM 728-1020332WWXXY 2060 - 2220	SYS 34W L: 1131mm LM 728-1020432WWXXY 2750 - 2960	SYS 41W L: 1411mm LM 728-1020532WWXXY 3440 - 3700
SYS 68W L: 2255mm LM 728-1020632WWXXY 5550 - 5920	SYS 82W L: 2816mm LM 728-1020732WWXXY 6880 - 7400	SYS 102W L: 3379mm LM 728-1020832WWXXY 8250 - 8800
SYS 123W L: 4220mm LM 728-1020932WWXXY 10320 - 11100		

Technical data and energy efficiency



LOG OUT 2.1 BINA OFFICE SD

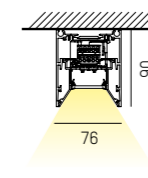
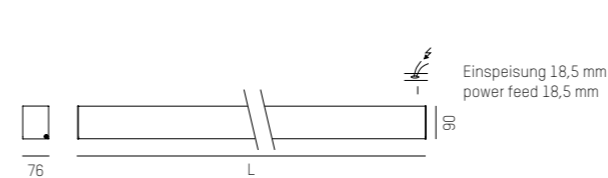

IP20 CE

COMPLETE CODE		
WW = LIGHT COLOUR	XX = COLOUR	Y = DIMMABLE
W2 LED 2700K = 13 CRI>80	W white = 56	S switchable = 0
W3 LED 3000K = 19 CRI>80	S black = 66	D DALI dimm. = d
W4 LED 4000K = 14 CRI>80	AE alu anodized = 86	



OPAL COVER

LOG OUT 2.1 IP54 SD MID OUTPUT / HIGH OUTPUT OPAL DIFFUSER
 220-240V AC 50/60Hz Design: INHOUSE

LED Aufbauleuchte aus Aluminiumprofil · Oberfläche pulverbeschichtet oder eloxiert · Abdeckung mit Opaldiffusor · IP54
 LED surface luminaire from aluminium profile · surface powder-coated or anodized · opal diffuser · IP54
 Lampada LED a plafone con profilo in alluminio · superficie verniciata a polveri o anodizzata · diffusore opale · IP54
 Plafonnier LED en profilé d'aluminium · surface lacquée en poudre ou anodisée · diffuseur opal · IP54

SYS 12W / 24W L: 870mm LM 728-10403LCWWXXY 1490 - 2950	SYS 16W / 31W L: 1151mm LM 728-10404LCWWXXY 1980 - 3930	SYS 20W / 40W L: 1431mm LM 728-10405LCWWXXY 2480 - 4920
SYS 32W / 62W L: 2275mm LM 728-10406LCWWXXY 3960 - 7860	SYS 40W / 80W L: 2836mm LM 728-10407LCWWXXY 4960 - 9840	SYS 48W / 93W L: 3399mm LM 728-10408LCWWXXY 5940 - 11790
SYS 60W / 120W L: 4240mm LM 728-10409LCWWXXY 7440 - 14760		

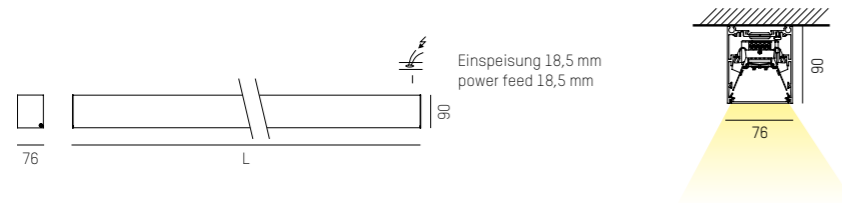

IP54



COMPLETE CODE				
L = LIGHT INSERT	C = COVER	WW = LIGHT COLOUR	XX = COLOUR	Y = DIMMABLE
M0 MID OUTPUT = 1	opal = 1	W2 LED 2700K = 13 CRI>80	W white = 50	S switchable = 0
H0 HIGH OUTPUT = 3		W3 LED 3000K = 19 CRI>80	S black = 60	D DALI dimm. = d
		W4 LED 4000K = 14 CRI>80	AE alu anodized = 80	

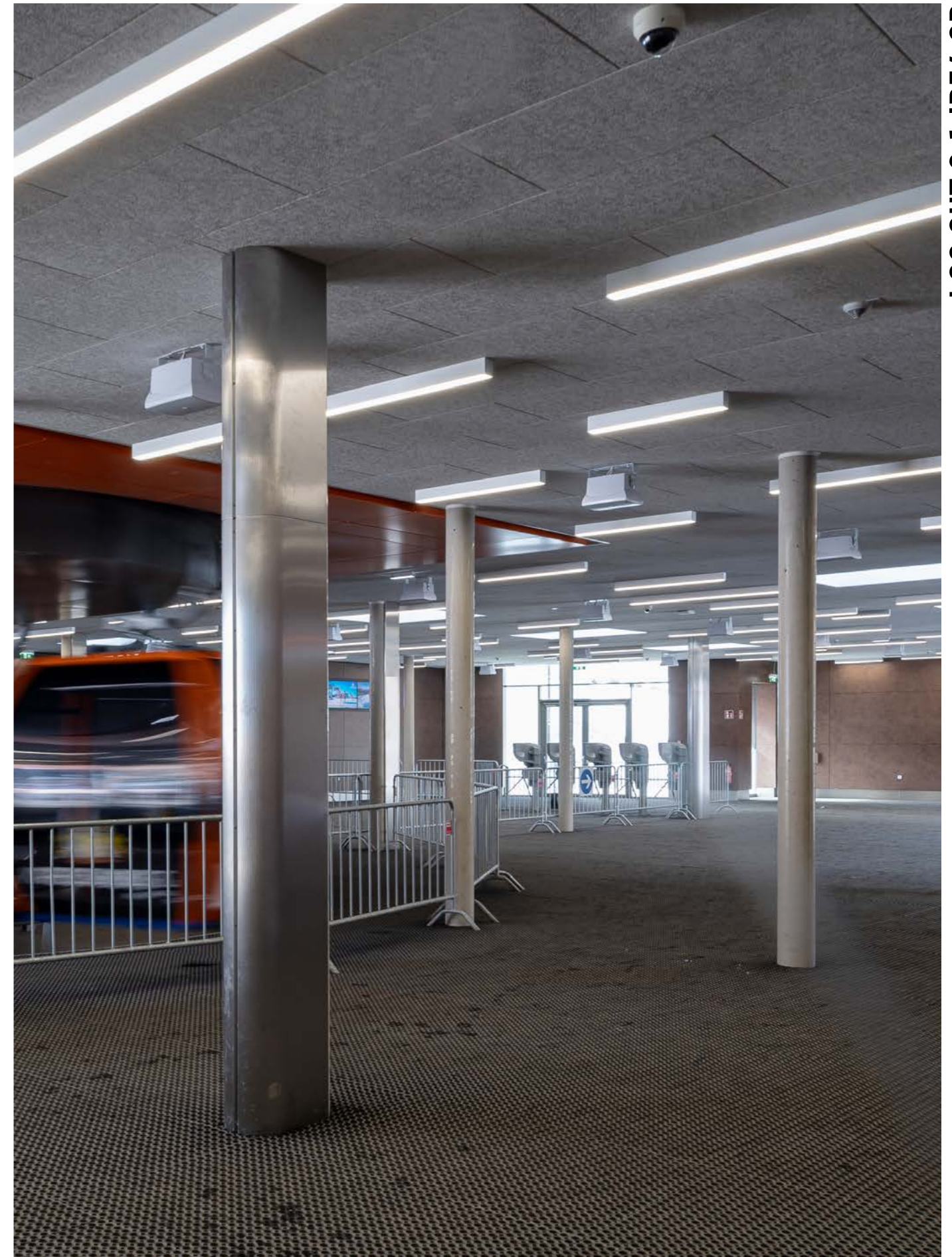

LOG OUT 2.1 IP54 SD

Technical data and energy efficiency

Kreischbergbahn
 Murau, Austria
 Photo: Joachim Rauch



LOG OUT 2.1 IP 54 SD

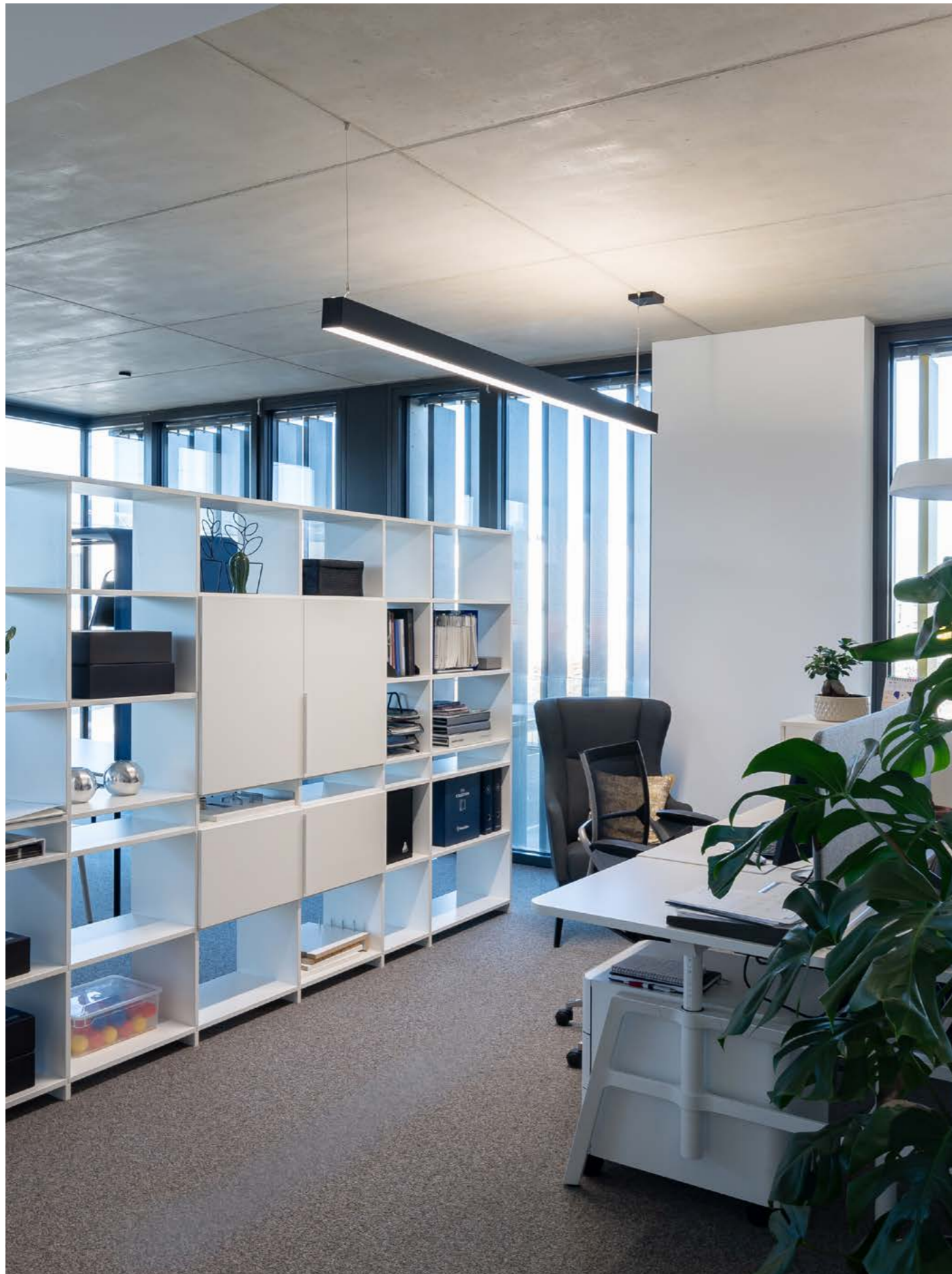

Wiesner & Hager
Graz, Austria
Photo: Joachim Rauch

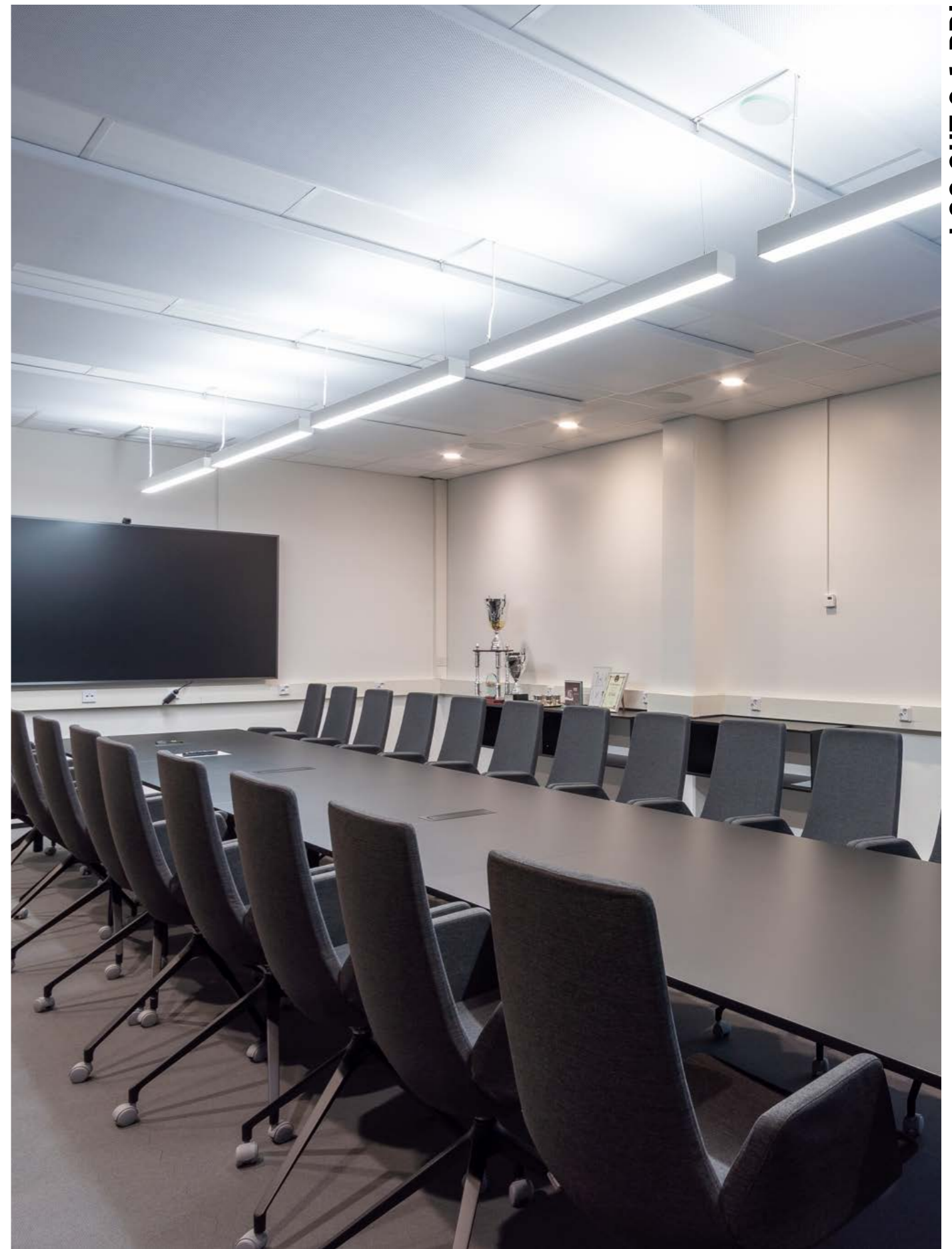

Mercedes-Benz Showroom Veho Vehkala
Helsinki, Finland
Photo: Kim Forssen



LOG OUT 2.1 PDI MID OUTPUT / HIGH OUTPUT OPAL / MICROPRISMATIC DIFFUSER
 220-240V AC 50/60Hz Design: INHOUSE

LED Pendelleuchte aus Aluminiumprofil · Oberfläche pulverbeschichtet oder eloxiert · Abdeckung mit Mikroprismenoptik oder Opaldiffuser
 LED pendant from aluminium profile · surface powder-coated or anodized · opal or microprismatic diffuser
 Sospensione con profilo in alluminio · superficie verniciata a polveri o anodizzata · diffusore opale o microprismatico
 Suspension en profilé d'aluminium · surface lacquée en poudre ou anodisée · diffuseur opal ou en microprisme

LOG OUT 2.1 BINA LENS PDI BINA LENS INSERT
 220-240V AC 50/60Hz **UGR<19** Design: INHOUSE

LED Pendelleuchte aus Aluminiumprofil · Oberfläche pulverbeschichtet oder eloxiert · schwarzer Lichteinsatz mit Linseneinsatz
 LED pendant from aluminium profile · surface powder-coated or anodized · black light insert with lens insert
 Sospensione con profilo in alluminio · superficie verniciata a polveri o anodizzata · inserto a luce nera con lente
 Suspension en profilé d'aluminium · surface lacquée en poudre ou anodisée · insert de lumière noire avec lentille

SYS 31W / 64W L: 1131mm LM	SYS 39W / 79W L: 1411mm LM	SYS 62W / 128W L: 2255mm LM
728-20104LCWWXXY 4100 - 8590	728-20105LCWWXXY 5130 - 10740	728-20106LCWWXXY 8200 - 17180

SYS 76W L: 1131mm LM	SYS 152W L: 2255mm LM	SYS 228W L: 3379mm LM
728-2070446WWXXY 8530 - 9130	728-2070646WWXXY 17060 - 18260	728-2070846WWXXY 25590 - 27390

SYS 78W / 158W L: 2816mm LM	SYS 93W / 192W L: 3379mm LM	SYS 117W / 237W L: 4220mm LM
728-20107LCWWXXY 10260 - 21480	728-20108LCWWXXY 12300 - 25770	728-20109LCWWXXY 15390 - 32220

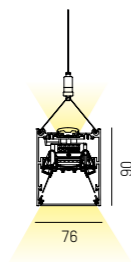
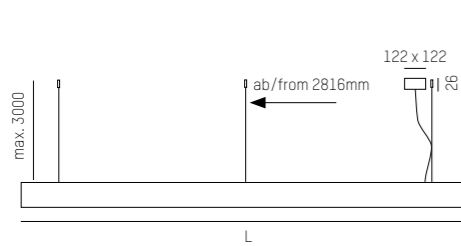

Technical data and energy efficiency



LOG OUT 2.1 PDI

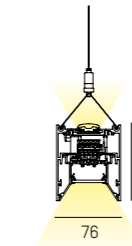
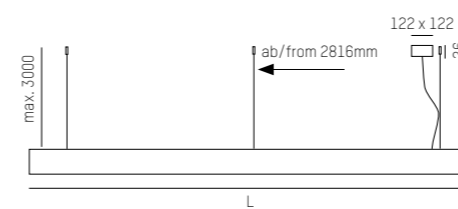

Technical data and energy efficiency



LOG OUT 2.1 BINA LENS PDI

IP20



COMPLETE CODE				
L = LIGHT INSERT	C = COVER	WW = LIGHT COLOUR	XX = COLOUR	Y = DIMMABLE
MO MID OUTPUT = 2	opal = 1	W2 LED 2700K = 13 CRI>80	W white = 50	switchable = 0
HO HIGH OUTPUT = 4	microprismatic foil = 8	W3 LED 3000K = 19 CRI>80	S black = 60	DALI dimm. = d
	UGR<19 (only MID OUTPUT)	W4 LED 4000K = 14 CRI>80	AE alu anodized = 80	

IP20



COMPLETE CODE		
WW = LIGHT COLOUR	XX = COLOUR	Y = DIMMABLE
W2 LED 2700K = 13 CRI>80	W white = 56	switchable = 0
W3 LED 3000K = 19 CRI>80	S black = 66	DALI dimm. = d
W4 LED 4000K = 14 CRI>80	AE alu anodized = 86	



OPAL WHITE INSERT

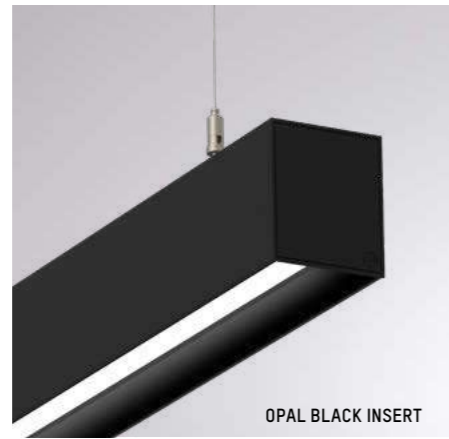

OPAL BLACK INSERT



MICROPRISMATIC OFFICE INSERT

LOG OUT 2.1 BINA PDI MID OUTPUT / HIGH OUTPUT BINA OPAL INSERT
 220-240V AC 50/60Hz Design: INHOUSE

LED Pendelleuchte aus Aluminiumprofil · Oberfläche pulverbeschichtet oder eloxiert · Lichteinsätze mit Opaldiffuser
 LED pendant from aluminium profile · surface powder-coated or anodized · light inserts with opal diffuser
 Sospensione con profilo in alluminio · superficie verniciata a polveri o anodizzata · Inserti luminosi con diffusore opale
 Suspension en profilé d'aluminium · surface lacquée en poudre ou anodisée · inserts lumineux avec diffuseur opale

SYS 31W / 64W	L: 1131mm	LM	SYS 39W / 79W	L: 1411mm	LM	SYS 62W / 128W	L: 2255mm	LM
728-20204 L1 WWXXY		3670 - 8600	728-20205 L1 WWXXY		4590 - 10750	728-20206 L1 WWXXY		7340 - 17200
SYS 78W / 158W	L: 2816mm	LM	SYS 93W 192W	L: 3379mm	LM	SYS 117W / 237W	L: 4220mm	LM
728-20207 L1 WWXXY		9180 - 21500	728-20208 L1 WWXXY		11010 - 25800	728-20209 L1 WWXXY		13770 - 32250

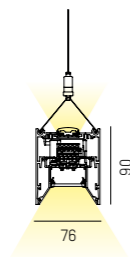
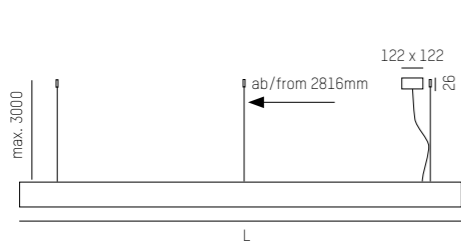

Technical data and energy efficiency



LOG OUT 2.1 BINA PDI

IP20



COMPLETE CODE				
L = LIGHT INSERT	WW = LIGHT COLOUR	X = COLOUR PROFILE	X = COLOUR LIGHT INSERT	Y = DIMMABLE
MO MID OUTPUT = 2	W2 LED 2700K = 13 CRI>80	W white = 5	W white = 5	S switchable = 0
HO HIGH OUTPUT = 4	W3 LED 3000K = 19 CRI>80	S black = 6	S black = 6	D DALI dimm. = d
	W4 LED 4000K = 14 CRI>80	AE alu anodized = 8		



LOG OUT 2.1 BINA OFFICE PDI BINA OFFICE INSERT
 220-240V AC 50/60Hz **UGR<19** Design: INHOUSE

LED Aufbauleuchte aus Aluminiumprofil · Oberfläche pulverbeschichtet oder eloxiert · schwarzer Lichteinsatz mit Mikroprismenoptik
 LED surface luminaire from aluminium profile · surface powder-coated or anodized · black light insert with microprismatic diffuser
 Sospensione con profilo in alluminio · superficie verniciata a polveri o anodizzata · inserto a luce nera con ottica a microprismi
 Suspension en profilé d'aluminium · surface lacquée en poudre ou anodisée · insert de lumière noire avec optique à microprisme

SYS 68W	L: 1131mm	LM	SYS 84W	L: 1411mm	LM	SYS 136W	L: 2255mm	LM
728-2020442 WWXXY		7140 - 7760	728-2020542 WWXXY		8930 - 9590	728-2020642 WWXXY		14280 - 15340
SYS 168W	L: 2816mm	LM	SYS 204W	L: 3379mm	LM	SYS 252W	L: 4220mm	LM
728-2020742 WWXXY		17860 - 19180	728-2020842 WWXXY		21420 - 23010	728-2020942 WWXXY		26790 - 28770

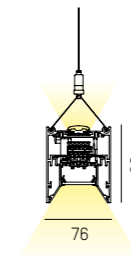
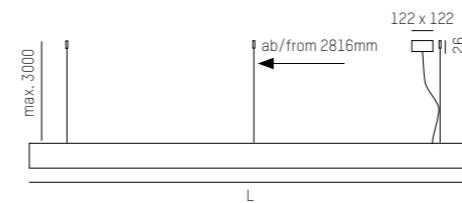

Technical data and energy efficiency



LOG OUT 2.1 BINA OFFICE PDI

IP20



COMPLETE CODE		
WW = LIGHT COLOUR	XX = COLOUR	Y = DIMMABLE
W2 LED 2700K = 13 CRI>80	W white = 56	S switchable = 0
W3 LED 3000K = 19 CRI>80	S black = 66	D DALI dimm. = d
W4 LED 4000K = 14 CRI>80	AE alu anodized = 86	



Ducati Flagship Store
Ingolstadt, Germany
Photo: Joachim Rauch



Kulturgarage
Vienna, Austria
Photo: Joachim Rauch



Niki Hasler AG
Cham, Switzerland
Photo: Sir Heian AG



LOG OUT 2.1 PD MID OUTPUT / HIGH OUTPUT OPAL / MICROPRISMATIC DIFFUSER
 220-240V AC 50/60Hz Design: INHOUSE

LED Pendelleuchte aus Aluminiumprofil · Oberfläche pulverbeschichtet oder eloxiert · Abdeckung mit Mikroprismenoptik oder Opaldiffusor
 LED pendant from aluminium profile · surface powder-coated or anodized · opal or microprismatic diffuser
 Sospensione con profilo in alluminio · superficie verniciata a polveri o anodizzata · diffusore opale o microprismatico
 Suspension en profilé d'aluminium · surface lacquée en poudre ou anodisée · diffuseur opal ou en microprisme

SYS 16W / 31W L: 1131mm LM	SYS 20W / 40W L: 1411mm LM	SYS 32W / 62W L: 2255mm LM
728-20104LCWWXXY 1940 - 3930	728-20105LCWWXXY 2430 - 4920	728-20106LCWWXXY 3880 - 7860
SYS 40W / 80W L: 2816mm LM	SYS 48W / 93W L: 3379mm LM	SYS 60W / 120W L: 4220mm LM
728-20107LCWWXXY 4860 - 9840	728-20108LCWWXXY 5820 - 11790	728-20109LCWWXXY 7290 - 14760

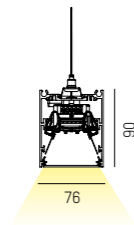
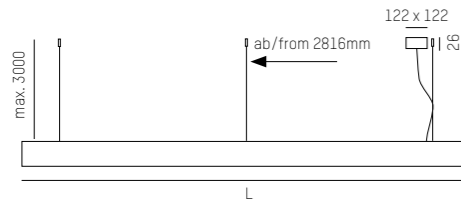

Technical data and energy efficiency



LOG OUT 2.1 PD

IP20



COMPLETE CODE				
L = LIGHT INSERT	C = COVER	WW = LIGHT COLOUR	XX = COLOUR	Y = DIMMABLE
MO MID OUTPUT = 1	opal = 1	W2 LED 2700K = 13 CRI>80	W white = 50	S switchable = 0
HO HIGH OUTPUT = 3	microprismatic foil = 8	W3 LED 3000K = 19 CRI>80	S black = 60	D DALI dimm. = d
	UGR<19 (only MID OUTPUT)	W4 LED 4000K = 14 CRI>80	AE alu anodized = 80	



LOG OUT 2.1 BINA LENS PD BINA LENS INSERT
 220-240V AC 50/60Hz **UGR<19** Design: INHOUSE

LED Pendelleuchte aus Aluminiumprofil · Oberfläche pulverbeschichtet oder eloxiert · schwarzer Lichteinsatz mit Linseneinsatz
 LED pendant from aluminium profile · surface powder-coated or anodized · black light insert with lens insert
 Sospensione con profilo in alluminio · superficie verniciata a polveri o anodizzata · inserto a luce nera con lente
 Suspension en profilé d'aluminium · surface lacquée en poudre ou anodisée · insert de lumière noire avec lentille

SYS 43W L: 1131mm LM	SYS 86W L: 2255mm LM	SYS 129W L: 3379mm LM
728-2070436WWXXY 4370 - 4650	728-2070636WWXXY 8740 - 9300	728-2070836WWXXY 13110 - 13950

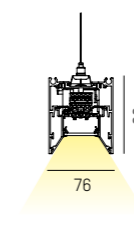
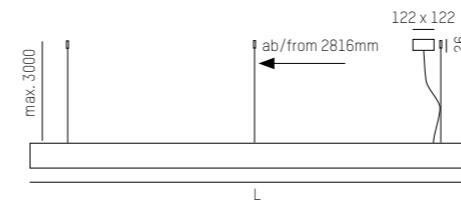

Technical data and energy efficiency



LOG OUT 2.1 BINA LENS PD

IP20



COMPLETE CODE		
WW = LIGHT COLOUR	XX = COLOUR	Y = DIMMABLE
W2 LED 2700K = 13 CRI>80	W white = 56	S switchable = 0
W3 LED 3000K = 19 CRI>80	S black = 66	D DALI dimm. = d
W4 LED 4000K = 14 CRI>80	AE alu anodized = 86	



OPAL WHITE INSERT



OPAL BLACK INSERT

LOG OUT 2.1 BINA PD MID OUTPUT / HIGH OUTPUT BINA OPAL INSERT
 220-240V AC 50/60Hz Design: INHOUSE

LED Pendelleuchte aus Aluminiumprofil · Oberfläche pulverbeschichtet oder eloxiert · Lichteinsätze schwarz oder weiß mit Opaldiffusor
 LED pendant from aluminium profile · surface powder-coated or anodized · light inserts black or white with opal diffuser
 Sospensione con profilo in alluminio · superficie verniciata a polveri o anodizzata · inserti luminosi neri o bianchi con diffusore opale
 Suspension en profilé d'aluminium · surface lacquée en poudre ou anodisée · inserts lumineux noirs ou blancs avec diffuseur opal

SYS 16W / 31W L: 1131mm LM	SYS 20W / 40W L: 1411mm LM	SYS 32W / 62W L: 2255mm LM
728-20204 L1 WWXXY 1510 - 4120	728-20205 L1 WWXXY 1890 - 5150	728-20206 L1 WWXXY 3020 - 8240
SYS 40W / 80W L: 2816mm LM	SYS 48W / 93W L: 3379mm LM	SYS 60W / 120W L: 4220mm LM
728-20207 L1 WWXXY 3780 - 10300	728-20208 L1 WWXXY 4530 - 12360	728-20209 L1 WWXXY 5670 - 15450

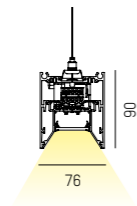
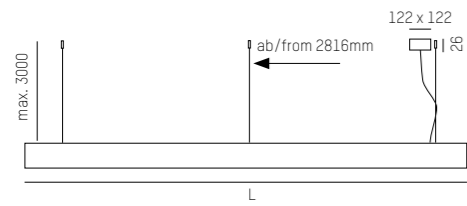

Technical data and energy efficiency



LOG OUT 2.1 BINA PD

IP20



COMPLETE CODE				
L = LIGHT INSERT	WW = LIGHT COLOUR	X = COLOUR PROFILE	X = COLOUR LIGHT INSERT	Y = DIMMABLE
MO MID OUTPUT = 1	W2 LED 2700K = 13 CRI>80	W white = 5	W white = 5	S switchable = 0
HO HIGH OUTPUT = 3	W3 LED 3000K = 19 CRI>80	S black = 6	S black = 6	D DALI dimm. = d
	W4 LED 4000K = 14 CRI>80	AE alu anodized = 8		

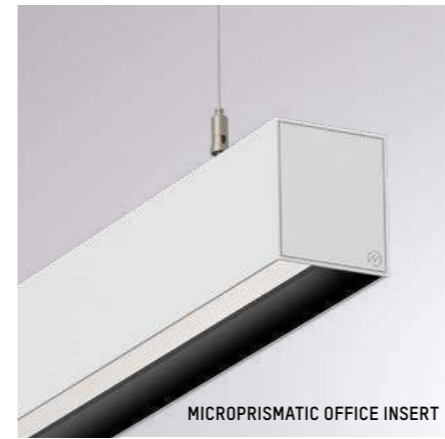

MICROPRISMATIC OFFICE INSERT

LOG OUT 2.1 BINA OFFICE PD BINA OFFICE INSERT
 220-240V AC 50/60Hz **UGR<19** Design: INHOUSE

LED Pendelleuchte aus Aluminiumprofil · Oberfläche pulverbeschichtet oder eloxiert · schwarzer Lichteinsatz mit Mikroprismenoptik
 LED pendant from aluminium profile · surface powder-coated or anodized · black light insert with microprismatic diffuser
 Sospensione con profilo in alluminio · superficie verniciata a polveri o anodizzata · inserto a luce nera con ottica a microprismi
 Suspension en profilé d'aluminium · surface lacquée en poudre ou anodisée · insert de lumière noire avec optique à microprisme

SYS 34W L: 1131mm LM	SYS 41W L: 1411mm LM	SYS 68W L: 2255mm LM
728-20204 32 WWXXY 2750 - 2960	728-20205 32 WWXXY 3440 - 3700	728-20206 32 WWXXY 5550 - 5920
SYS 82W L: 2816mm LM	SYS 102W L: 3379mm LM	SYS 123W L: 4220mm LM
728-20207 32 WWXXY 6880 - 7400	728-20208 32 WWXXY 8250 - 8800	728-20209 32 WWXXY 10320 - 11100

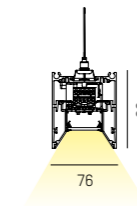
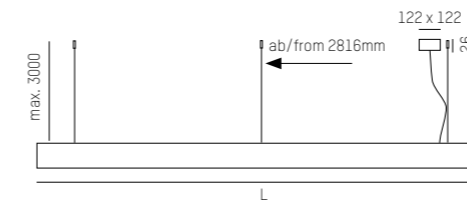

Technical data and energy efficiency



LOG OUT 2.1 BINA OFFICE PD

IP20



COMPLETE CODE		
WW = LIGHT COLOUR	XX = COLOUR	Y = DIMMABLE
W2 LED 2700K = 13 CRI>80	W white = 56	S switchable = 0
W3 LED 3000K = 19 CRI>80	S black = 66	D DALI dimm. = d
W4 LED 4000K = 14 CRI>80	AE alu anodized = 86	

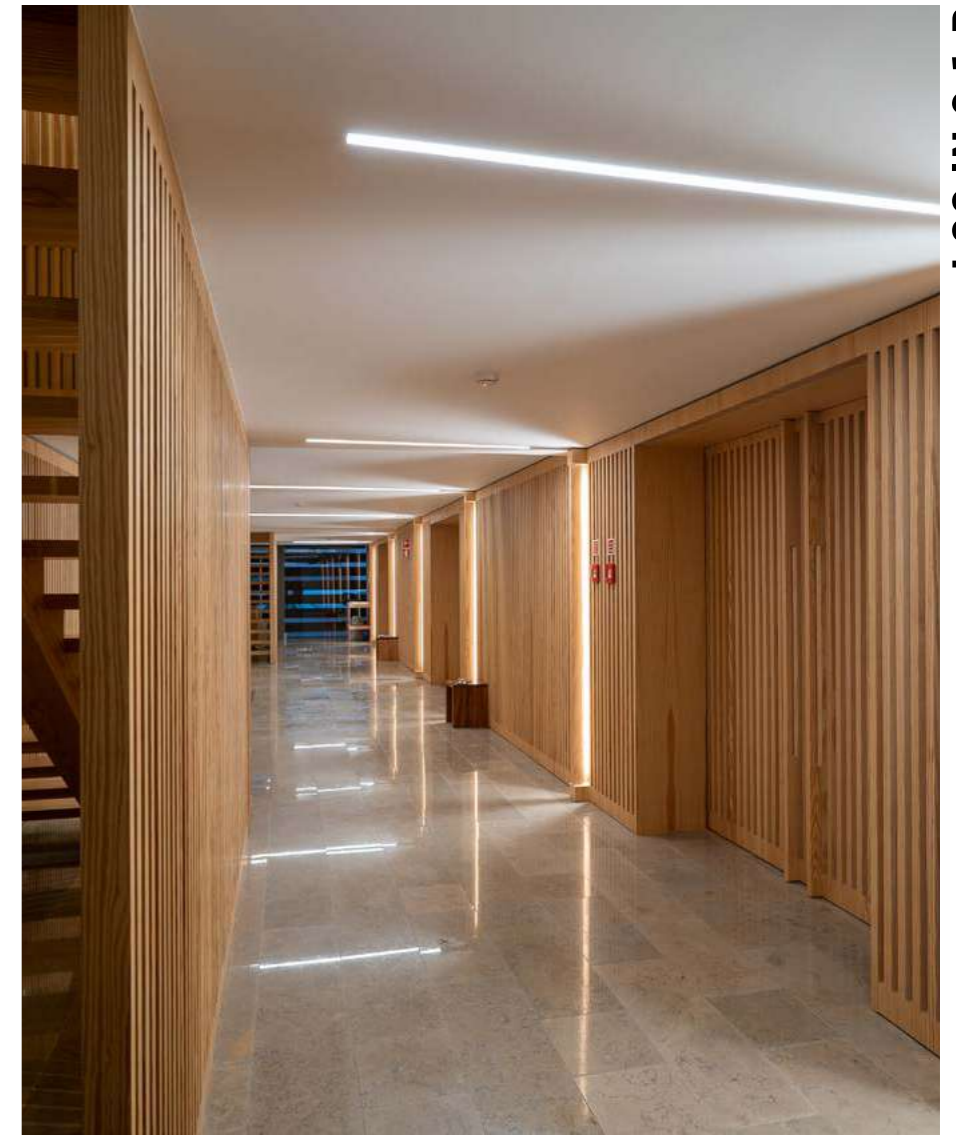

LOG IN 2.1 R

Complexo Social da Abóboda & Convento de São Domingos de Benfca
Lisboa, Portugal
Photo: AURA Light

Truckcenter Katzinger
Altenfelden, Austria
Leibez Interieur Design
Photo: Stöbich



LOG IN 2.1 R MID OUTPUT / HIGH OUTPUT OPAL / MICROPRISMATIC DIFFUSER
220-240V AC 50/60Hz Design: INHOUSE

LED Einbauleuchte aus Aluminiumprofil · Oberfläche pulverbeschichtet oder eloxiert · Abdeckung mit Mikroprismenoptik oder Opaldiffusor
LED recessed luminaire from aluminium profile · surface powder-coated or anodized · opal or microprismatic diffuser
Lampada ad incasso con profilo in alluminio · superficie verniciata a polveri o anodizzata · diffusore opale o microprismatico
Luminaire encastré en profilé d'aluminium · surface lacquée en poudre ou anodisée · diffuseur opal ou en microprisme

SYS 12W / 24W L: 866mm LM 728-30103LCWWXXY 1450 - 2950	SYS 16W / 31W L: 1147mm LM 728-30104LCWWXXY 1940 - 3930	SYS 20W / 40W L: 1427mm LM 728-30105LCWWXXY 2430 - 4920
SYS 32W / 62W L: 2271mm LM 728-30106LCWWXXY 3880 - 7860	SYS 40W / 80W L: 2832mm LM 728-30107LCWWXXY 4860 - 9840	SYS 48W / 93W L: 3395mm LM 728-30108LCWWXXY 5820 - 11790
SYS 60W / 120W L: 4236mm LM 728-30109LCWWXXY 7290 - 14760		

LOG IN 2.1 BINA LENS R BINA LENS INSERT
220-240V AC 50/60Hz UGR<19 Design: INHOUSE

LED Einbauleuchte aus Aluminiumprofil · Oberfläche pulverbeschichtet oder eloxiert · schwarzer Lichteinsatz mit Linseneinsatz
LED recessed luminaire from aluminium profile · surface powder-coated or anodized · black light insert with lens insert
Lampada ad incasso con profilo in alluminio · superficie verniciata a polveri o anodizzata · inserto a luce nera con lente
Luminaire encastré en profilé d'aluminium · surface lacquée en poudre ou anodisée · insert de lumière noire avec lentille

SYS 43W L: 1147mm LM 728-3070436WWXXY 4370 - 4650	SYS 86W L: 2271mm LM 728-3070636WWXXY 8740 - 9300	SYS 129W L: 3395mm LM 728-3070836WWXXY 13110 - 13950
--	--	---

Technical data and energy efficiency

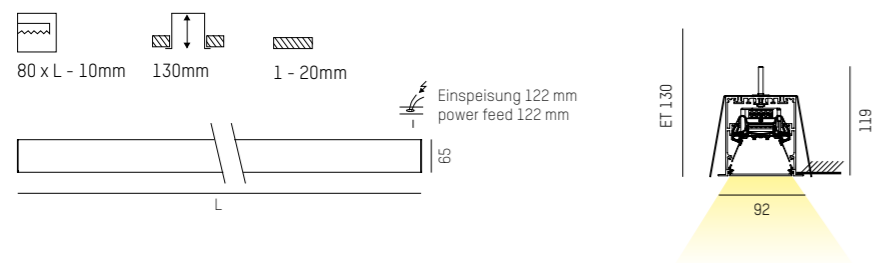

LOG IN 2.1 R

Technical data and energy efficiency

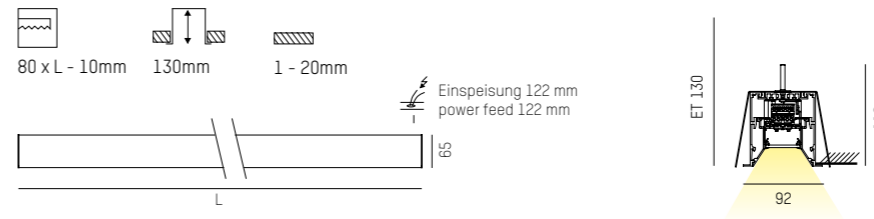

LOG IN 2.1 BINA LENS R

IP20 CE



COMPLETE CODE				
L = LIGHT INSERT	C = COVER	WW = LIGHT COLOUR	XX = COLOUR	Y = DIMMABLE
MO MID OUTPUT = 1 HO HIGH OUTPUT = 3	opal = 1 microprismatic foil = 8 UGR<19 (only MID OUTPUT)	W2 LED 2700K = 13 CRI>80 W3 LED 3000K = 19 CRI>80 W4 LED 4000K = 14 CRI>80	W white = 50 S black = 60 AE alu anodized = 80	Ⓢ switchable = 0 Ⓣ DALI dimm. = d



COMPLETE CODE		
WW = LIGHT COLOUR	XX = COLOUR	Y = DIMMABLE
W2 LED 2700K = 13 CRI>80 W3 LED 3000K = 19 CRI>80 W4 LED 4000K = 14 CRI>80	W white = 56 S black = 66 AE alu anodized = 86	Ⓢ switchable = 0 Ⓣ DALI dimm. = d



LOG IN 2.1 BINA R MID OUTPUT / HIGH OUTPUT BINA OPAL INSERT
 220-240V AC 50/60Hz Design: INHOUSE

LED Einbauleuchte aus Aluminiumprofil · Oberfläche pulverbeschichtet oder eloxiert · Lichteinsätze schwarz oder weiß mit Opaldiffusor
 LED recessed luminaire from aluminium profile · surface powder-coated or anodized · light inserts black or white with opal diffuser
 Lampada ad incasso con profilo in alluminio · superficie verniciata a polveri o anodizzata · inserti luminosi neri o bianchi con diffusore opale
 Luminaire encastré en profilé d'aluminium · surface lacquée en poudre ou anodisée · inserts lumineux noirs ou blancs avec diffuseur opal

SYS 12W / 24W L: 866mm LM 728-30203L1WWXXY 1130 - 3090	SYS 16W / 31W L: 1147mm LM 728-30204L1WWXXY 1510 - 4120	SYS 20W / 40W L: 1427mm LM 728-30205L1WWXXY 1890 - 5150
SYS 32W / 62W L: 2271mm LM 728-30206L1WWXXY 3020 - 8240	SYS 40W / 80W L: 2832mm LM 728-30207L1WWXXY 3780 - 10300	SYS 48W / 93W L: 3395mm LM 728-30208L1WWXXY 4530 - 12360
SYS 60W / 120W L: 4236mm LM 728-30209L1WWXXY 5670 - 15450		

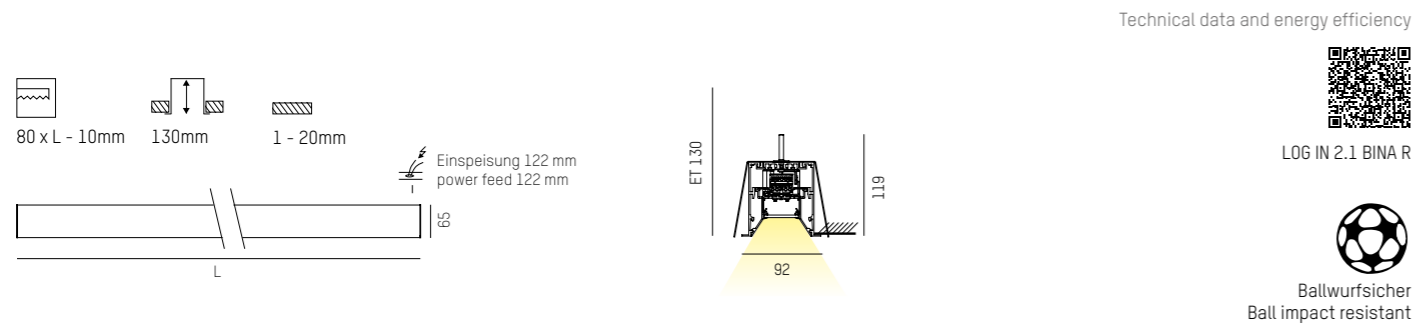

IP20 CE

COMPLETE CODE				
L = LIGHT INSERT	WW = LIGHT COLOUR	X = COLOUR	X = COLOUR LIGHT INSERT	Y = DIMMABLE
M0 MID OUTPUT = 1	W2 LED 2700K = 13 CRI>80	W white = 5	W white = 5	S switchable = 0
H0 HIGH OUTPUT = 3	W3 LED 3000K = 19 CRI>80	S black = 6	S black = 6	D DALI dimm. = d
	W4 LED 4000K = 14 CRI>80	AE alu anodized = 8		

LOG IN 2.1 BINA OFFICE R BINA OFFICE INSERT
 220-240V AC 50/60Hz **UGR<19** Design: INHOUSE

LED Einbauleuchte aus Aluminiumprofil · Oberfläche pulverbeschichtet oder eloxiert · schwarzer Lichteinsatz mit Mikroprismenoptik
 LED recessed luminaire from aluminium profile · surface powder-coated or anodized · black light insert with microprismatic diffuser
 Lampada ad incasso con profilo in alluminio · superficie verniciata a polveri o anodizzata · inserto a luce nera con ottica a microprismi
 Luminaire encastré en profilé d'aluminium · surface lacquée en poudre ou anodisée · insert de lumière noire avec optique à microprisme

SYS 26W L: 866mm LM 728-3020332WWXXY 2060 - 2220	SYS 34W L: 1147mm LM 728-3020432WWXXY 2750 - 2960	SYS 41W L: 1427mm LM 728-3020532WWXXY 3440 - 3700
SYS 68W L: 2271mm LM 728-3020632WWXXY 5550 - 5920	SYS 82W L: 2832mm LM 728-3020732WWXXY 6880 - 7400	SYS 102W L: 3395mm LM 728-3020832WWXXY 8250 - 8800
SYS 123W L: 4236mm LM 728-3020932WWXXY 10320 - 11100		

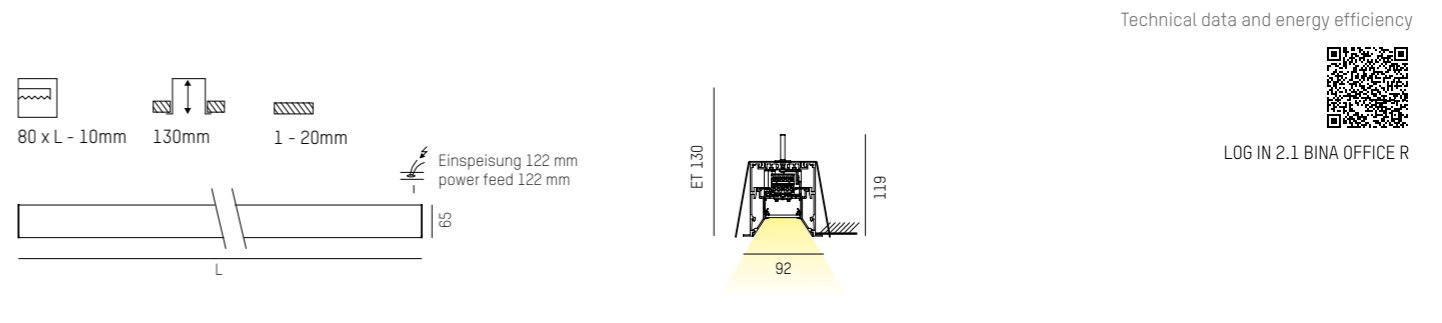

IP20 CE

COMPLETE CODE		
WW = LIGHT COLOUR	XX = COLOUR	Y = DIMMABLE
W2 LED 2700K = 13 CRI>80	W white = 56	S switchable = 0
W3 LED 3000K = 19 CRI>80	S black = 66	D DALI dimm. = d
W4 LED 4000K = 14 CRI>80	AE alu anodized = 86	

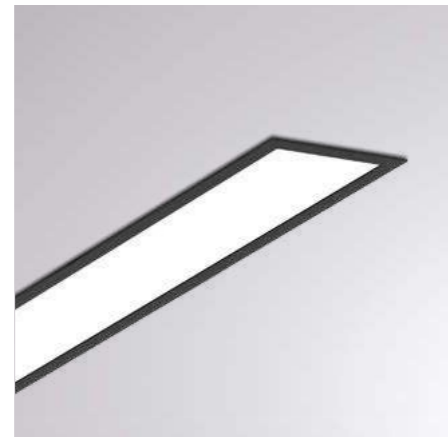

OPAL COVER

LOG IN 2.1 IP54 R MID OUTPUT / HIGH OUTPUT OPAL DIFFUSER
 220-240V AC 50/60Hz Design: INHOUSE

LED Einbauleuchte aus Aluminiumprofil · Oberfläche pulverbeschichtet oder eloxiert · Abdeckung mit Opaldiffusor · IP54
 LED recessed luminaire from aluminium profile · surface powder-coated or anodized · opal diffuser · IP54
 Lampada ad incasso con profilo in alluminio · superficie verniciata a polveri o anodizzata · diffusore opale · IP54
 Luminaire encastré en profilé d'aluminium · surface lacquée en poudre ou anodisée · diffuseur opal · IP54

SYS 12W / 24W L: 886mm LM 728-30403LCWWXXY 1490 - 2950	SYS 16W / 31W L: 1167mm LM 728-30404LCWWXXY 1980 - 3930	SYS 20W / 40W L: 1447mm LM 728-30405LCWWXXY 2480 - 4920
SYS 32W / 62W L: 2291mm LM 728-30406LCWWXXY 3960 - 7860	SYS 40W / 80W L: 2852mm LM 728-30407LCWWXXY 4960 - 9840	SYS 48W / 93W L: 3415mm LM 728-30408LCWWXXY 5940 - 11790
SYS 60W / 120W L: 4256mm LM 728-30409LCWWXXY 7440 - 14760		

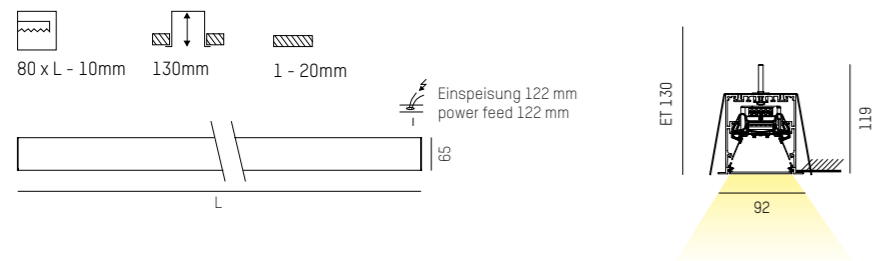

IP54



COMPLETE CODE				
L = LIGHT INSERT	C = COVER	WW = LIGHT COLOUR	XX = COLOUR	Y = DIMMABLE
M0 MID OUTPUT = 1	opal = 1	W2 LED 2700K = 13 CRI>80	W white = 50	S switchable = 0
H0 HIGH OUTPUT = 3		W3 LED 3000K = 19 CRI>80	S black = 60	D DALI dimm. = d
		W4 LED 4000K = 14 CRI>80	AE alu anodized = 80	

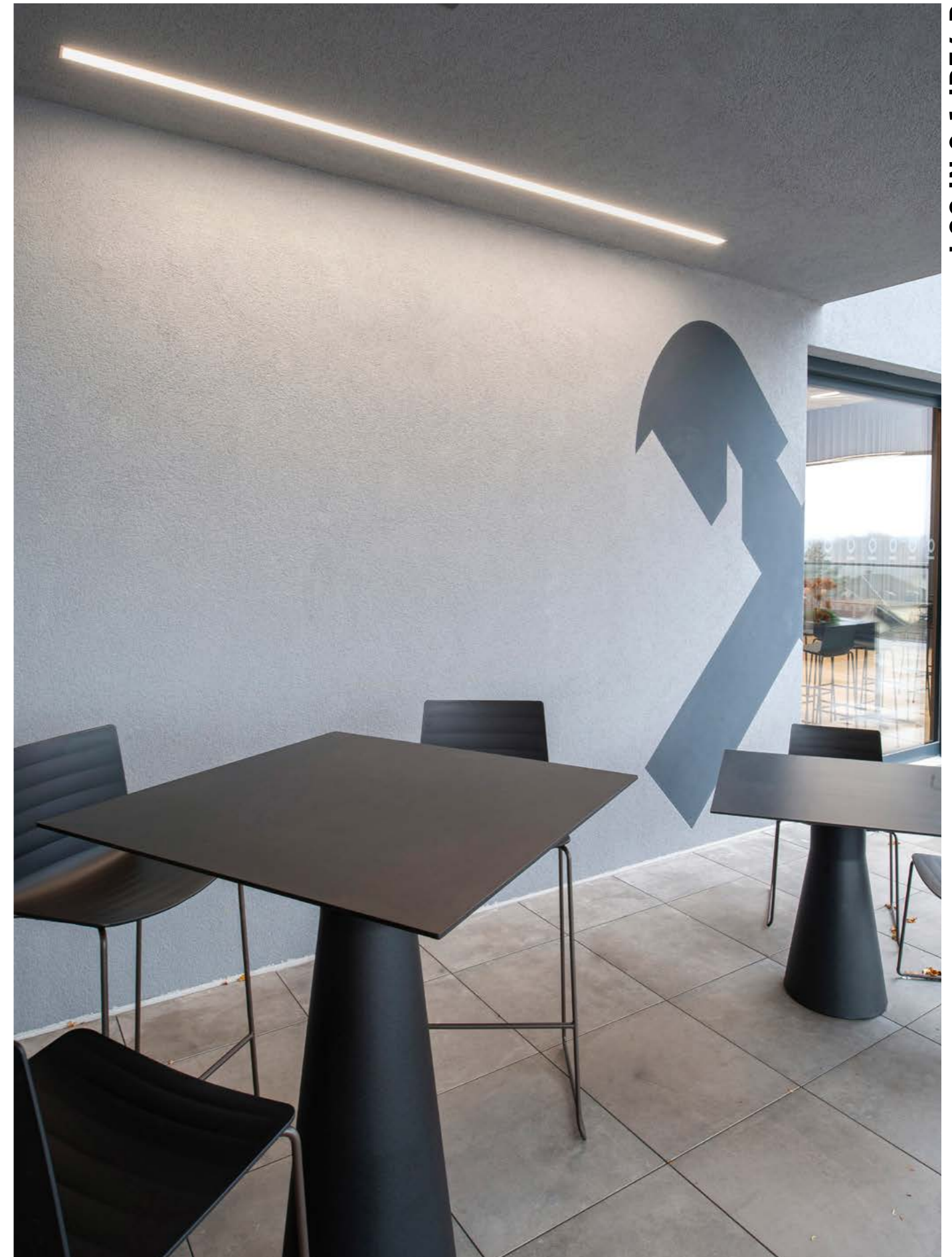

LOG IN 2.1 IP54 R

Technical data and energy efficiency

Raiffeisenbank
 Steyr, Austria
 Design + Architektur AREA.at
 Photo: Joachim Rauch



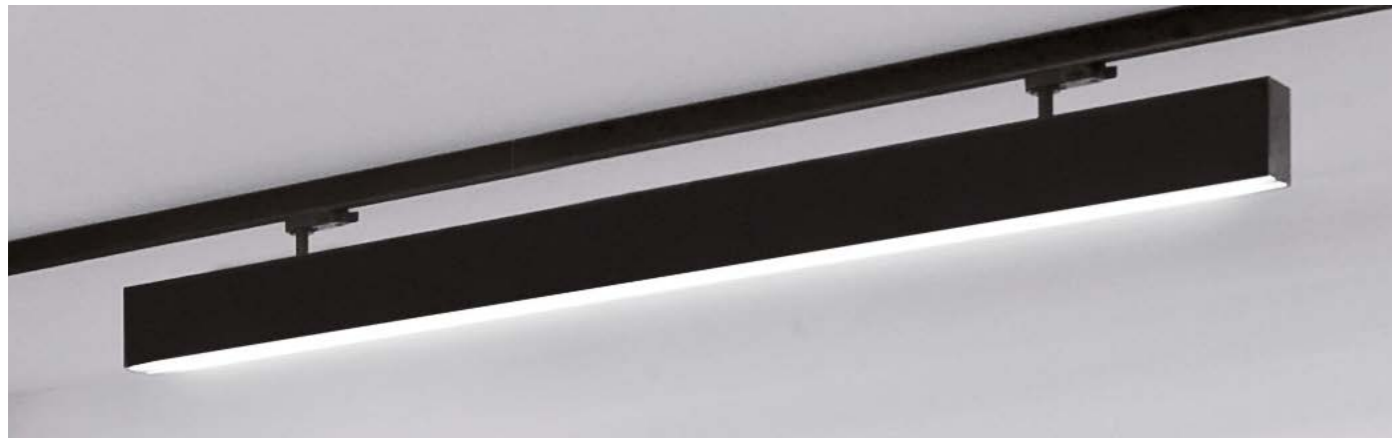

LOG OUT 2.1 TRACK MID OUTPUT / HIGH OUTPUT OPAL / MICROPRISMATIC DIFFUSER
 220-240V AC 50/60Hz Design: INHOUSE

LED Schienenteuchte aus Aluminiumprofil · Oberfläche pulverbeschichtet oder eloxiert · mit Opal oder Mikroprismendiffuser erhältlich
 LED track luminaire from aluminium profile · surface powder-coated or anodized · available with opal or microprismatic diffuser
 Proiettore da binario in alluminio · superficie verniciata a polveri o anodizzata · diffusore opale o microprismatico
 Spot pour rail en profilé d'aluminium · surface lacquée en poudre ou anodisée · diffuseur opal ou microprismatique

SYS 16W/31W L: 1131mm LM
 728-50104LCWWXXY 1940 - 3930

SYS 20W/40W L: 1411mm LM
 728-50105LCWWXXY 2430 - 4920

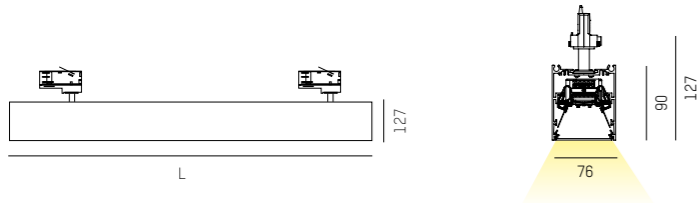

IP20



COMPLETE CODE				
L = LIGHT INSERT	C = COVER	WW = LIGHT COLOUR	XX = COLOUR	Y = DIMMABLE
MO MID OUTPUT = 1	opal = 1	W2 LED 2700K = 13 CRI>80	W white = 50	S switchable = 0
HO HIGH OUTPUT = 3	microprismatic foil = 8 UGR<19 (only MID OUTPUT)	W3 LED 3000K = 19 CRI>80	S black = 60	P PULSE DALI dimm. = p
		W4 LED 4000K = 14 CRI>80	AE alu anodized = 80	

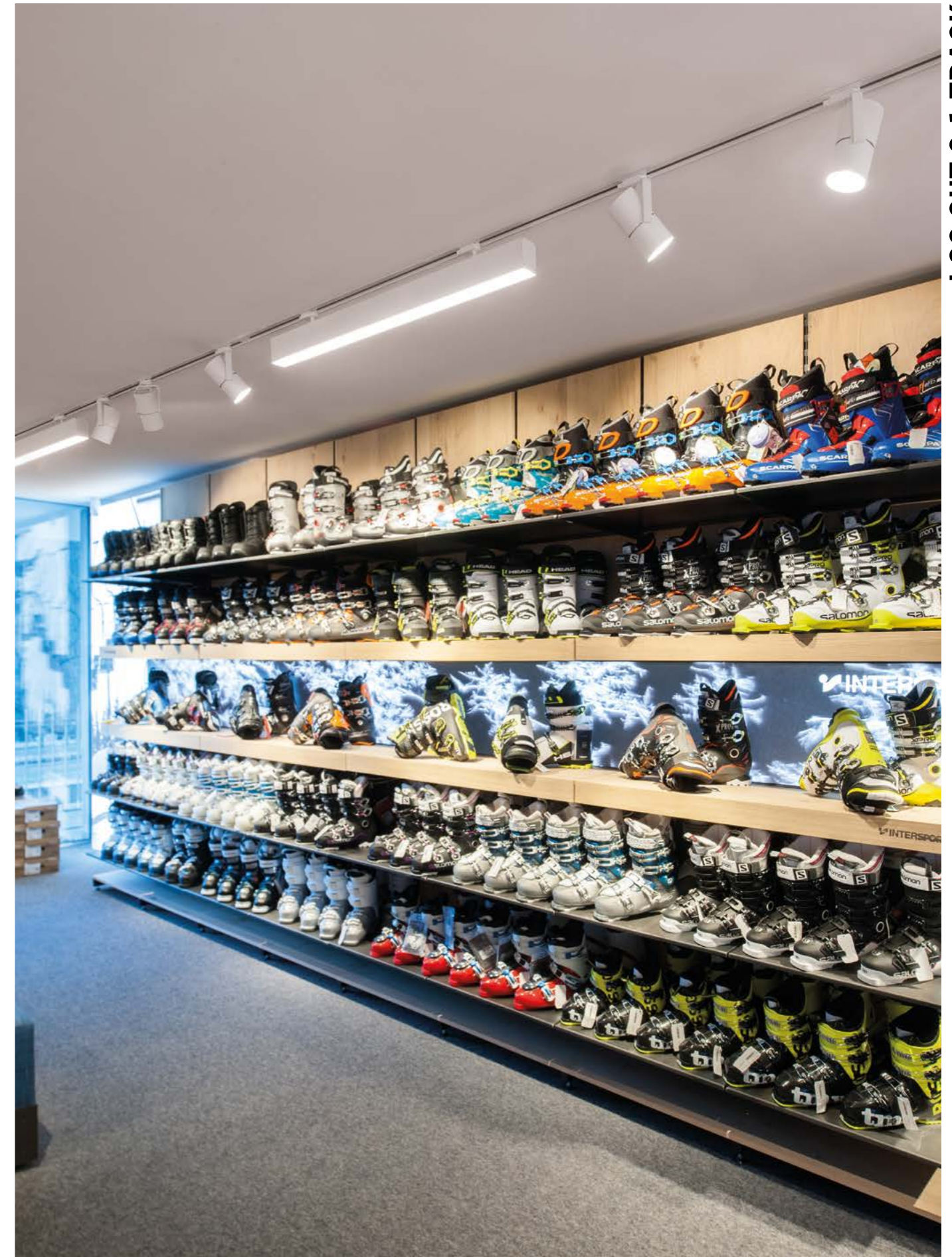

LOG OUT 2.1 TRACK

Technical data and energy efficiency



LOG OUT 2.1 TRACK

Intersport Patterer
 Krimml, Austria
 Photo: Joachim Rauch



OPAL COVER



MICROPRISMATIC COVER

LOG OUT UP/DOWN PDI

220-240V AC 50/60Hz Design: INHOUSE

OPAL / MICROPRISMATIC DIFFUSER

LED Aufbauleuchte aus Aluminiumprofil · Oberfläche pulverbeschichtet oder eloxiert · Abdeckung mit Mikroprismenoptik oder Opaldiffusor
 LED surface luminaire from aluminium profile · surface powder-coated or anodized · opal or microprismatic diffuser
 Lampada LED a plafone con profilo in alluminio · superficie verniciata a polveri o anodizzata · diffusore opale o microprismatico
 Plafonnier LED en profilé d'aluminium · surface lacquée en poudre ou anodisée · diffuseur opal ou en microprisme

SYS 42W	L: 870mm	LM
581-401WXCC		3500 - 3920

SYS 54W	L: 1156mm	LM
581-411WXCC		4670 - 5230

SYS 68W	L: 1441mm	LM
581-421WXCC		5840 - 6540

SYS 108W	L: 2299mm	LM
581-431WXCC		9350 - 10470

SYS 136W	L: 2869mm	LM
581-441WXCC		11690 - 13090

SYS 162W	L: 3442mm	LM
581-451WXCC		14030 - 15710

SYS 202W	L: 4297mm	LM
581-461WXCC		17540 - 19640

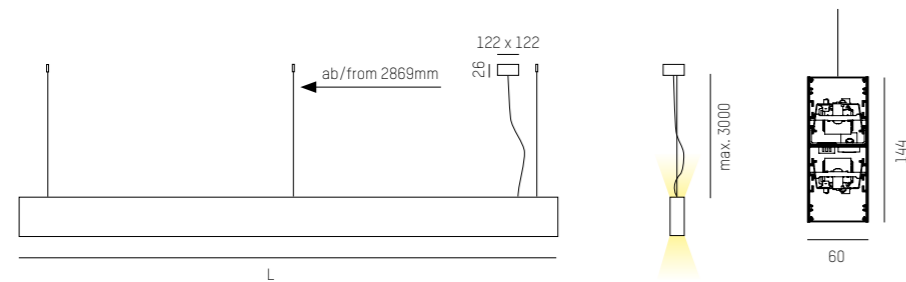

IP20 CE



COMPLETE CODE			
W = LIGHT COLOUR	X = COLOUR	C = COVER	Y = DIMMABLE
W3 LED 3000K = 9 CRI>80	W white = 5	Opal = pm	Ⓢ switchable = no addition
W4 LED 4000K = 10 CRI>80	S black = 6	Microprismatic = mp UGR<19	Ⓣ DALI dimm. = code + ddd
	AE alu anodized = 8		

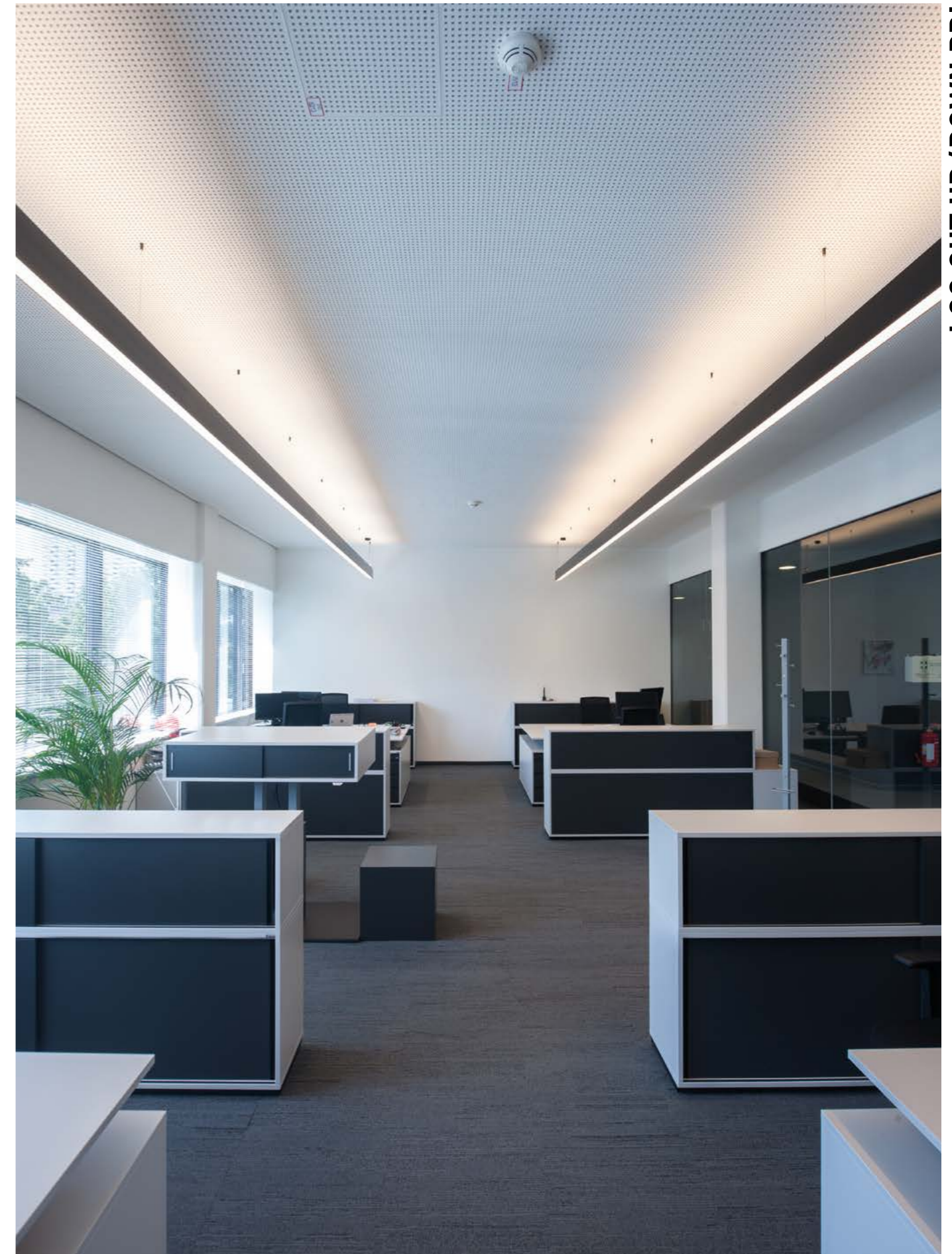

LOG OUT UP/DOWN PDI

Technical data and energy efficiency



Hilti Headquarter
 Vienna, Austria
 Photo: Joachim Rauch

LOG OUT UP/DOWN PDI



LOG OUT UP/DOWN W

220-240V AC 50/60Hz Design: INHOUSE

OPAL / MICROPRISMATIC DIFFUSER

LED Wandleuchte aus Aluminiumprofil · Oberfläche pulverbeschichtet oder eloxiert · Abdeckung mit Mikroprismenoptik oder Opaldiffusor
 LED wall luminaire from aluminium profile · surface powder-coated or anodized · opal or microprismatic diffuser
 Lampada a parete con profilo in alluminio · superficie verniciata a polveri o anodizzata · diffusore opale o microprismatico
 Applique LED en profilé d'aluminium · surface laquée en poudre ou anodisée · diffuseur opal ou en microprisme

SYS 42W	L: 870mm	LM	SYS 54W	L: 1156mm	LM	SYS 68W	L: 1441mm	LM
581-40W XCC		3500 - 3920	581-41W XCC		4670 - 5230	581-42W XCC		5840 - 6540
SYS 108W	L: 2299mm	LM	SYS 136W	L: 2869mm	LM	SYS 162W	L: 3442mm	LM
581-43W XCC		9350 - 10470	581-44W XCC		11690 - 13090	581-45W XCC		14030 - 15710
SYS 202W	L: 4297mm	LM						
581-46W XCC		17540 - 19640						

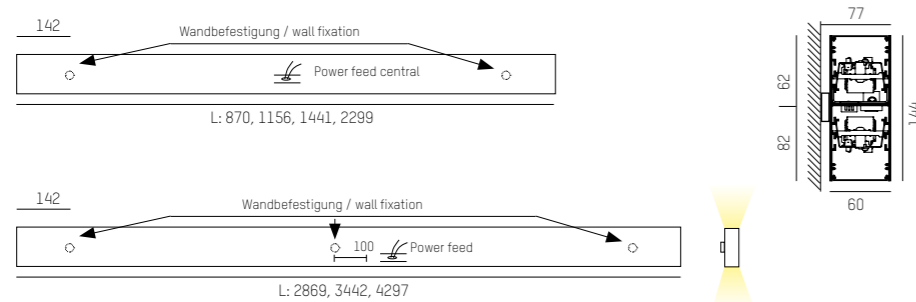

IP20 Ⓢ CE



COMPLETE CODE			
W = LIGHT COLOUR	X = COLOUR	C = COVER	Y = DIMMABLE
W3 LED 3000K = 9 CRI>80	W white = 5	Opal = pm	Ⓢ switchable = no addition
W4 LED 4000K = 10 CRI>80	S black = 6	microprismatic = mp UGR<19	Ⓣ DALI dimm. = code + ddd
	AE alu anodized = 8		

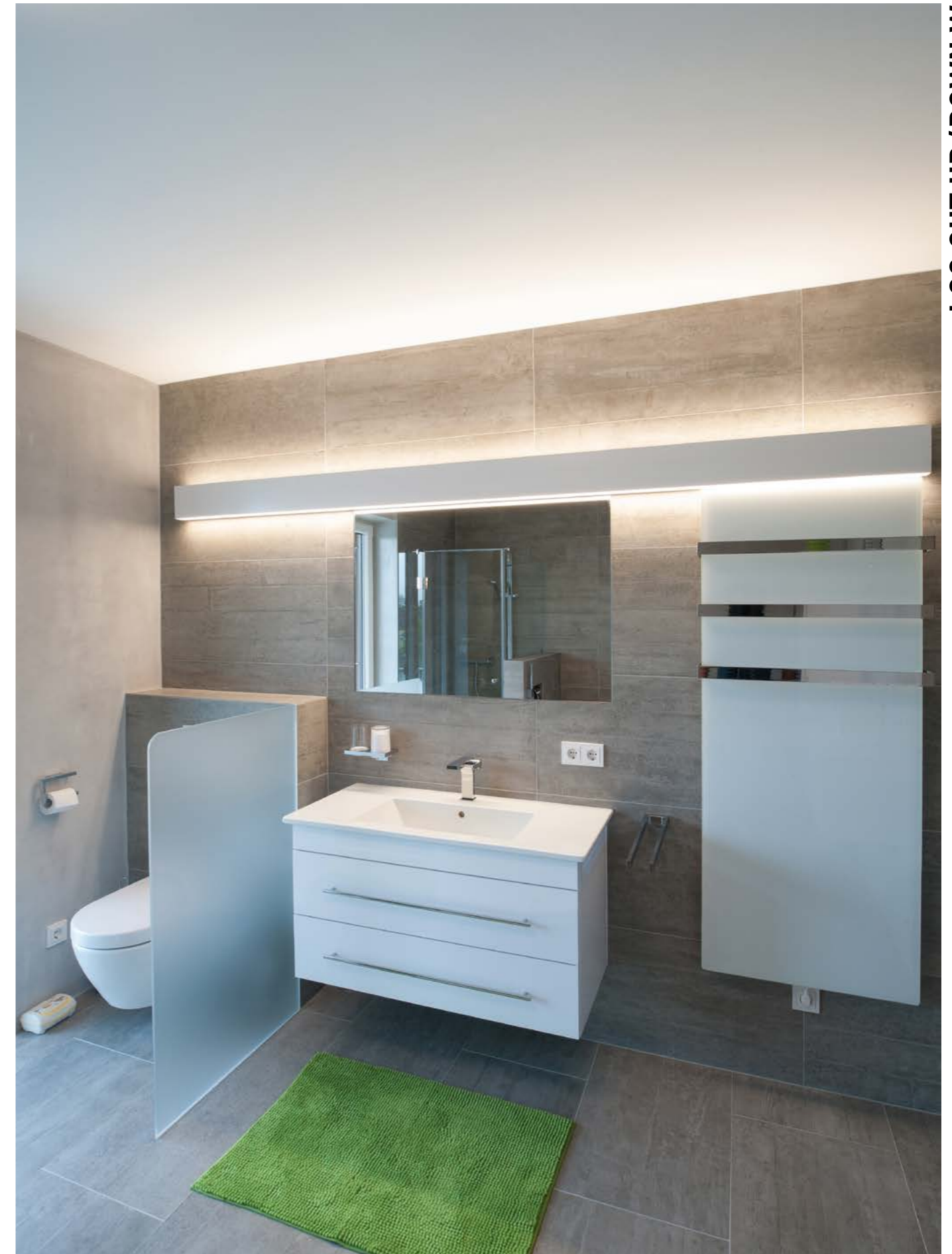

LOG OUT UP/DOWN W

Technical data and energy efficiency



Private residence
Austria
Photo: Joachim Rauch

LOG OUT UP/DOWN W

PROFILE

PROFILSYSTEM PROFILE SYSTEM	LÄNGE LENGHT	FÜR LICHTEINSATZ FOR LIGHT INSERT	PROFIL OBJEKT PROFILE OBJECT	LÄNGE LENGHT	ENDECKEL END PIECE	SET SET
581-2X583	583mm	SYS 2 x 15W	581-1X4500	4500mm	581-06X	2 pcs.
581-2X869	869mm	SYS 2 x 21W			inkl. Erdungskabel incl. ground cable	
581-2X1155	1155mm	SYS 2 x 27W				
581-2X2300	2300mm	SYS 4 x 27W				
581-2X3445	3445mm	SYS 6 x 27W				
581-2X1440	1440mm	SYS 2 x 34W				
581-2X2870	2870mm	SYS 4 x 34W				
581-2X4300	4300mm	SYS 6 x 34W				

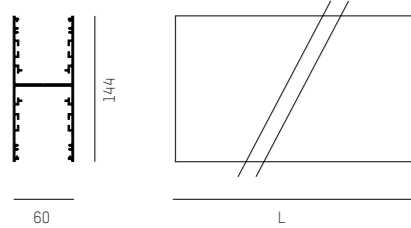

Abdeckungen, Lichteinsätze und Zubehör separat ordern
Order covers, light inserts and components separately

Technical data and energy efficiency



LOG OUT UP/DOWN SYSTEM

COMPLETE CODE FORPROFILE

X = COLOUR

W white = 5 **S** black = 6 **AE** alu anodized = 8

LIGHT INSERTS

LICHTEINSÄTZE LIGHT INSERTS	LÄNGE LENGHT	SYS SYS	LM LM
528-20W	571mm	SYS 15W	1730 - 1830
528-24W	857mm	SYS 21W	2600 - 2740
528-25W	1143mm	SYS 27W	3470 - 3660
528-26W	1428mm	SYS 34W	4340 - 4580

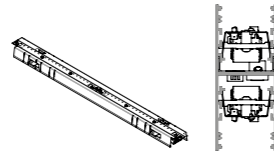

COMPLETE CODE FORPROFILE

W = LIGHT COLOUR

W3 LED 3000K = 9 CRI>80 **W4** LED 4000K = 10 CRI>80

3 CIRCUIT TRACK

SCHIENE TRACK	LÄNGE LENGHT
208-1910510X	1000mm
208-1910520X	2000mm
208-1910530X	3000mm

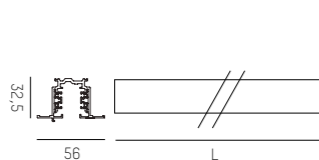

MONTAGESSET MOUNTING SET	FÜR FOR
581-09	3 circuit track

Distanz: jede 1000mm - 1 set
distance: every 1000mm - 1 set

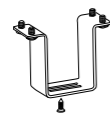

Zubehör für 3-Phasen Stromschiene: Seite 306-311
Components for 3-circuit track: page 306-311

COMPLETE CODE FORPROFILE

X = COLOUR

S black = 2 **W** white = 3 **G** grey = 5

COVERS

UGR<19

MIKROPRISMA MICROPRISMA	LÄNGE LENGHT
528-970583	582mm
528-970869	868mm
528-9701155	1154mm
528-9701440	1439mm
528-9702300	2298mm
528-9702870	2869mm
528-9703445	3443mm
528-9704300	4298mm
528-9704500	4500mm

PMMA OPAL

PMMA OPAL PMMA OPAL	LÄNGE LENGHT
528-405583	582mm
528-405869	868mm
528-4051155	1154mm
528-4051440	1439mm
528-4052300	2298mm
528-4052870	2869mm
528-4053445	3443mm
528-4054300	4298mm
528-1804500	4500mm

PMMA KLAR

PMMA KLAR PMMA CLEAR	LÄNGE LENGHT
581-980583	582mm
528-980869	868mm
528-9801155	1154mm
528-9801440	1439mm
528-9802300	2298mm
528-9802870	2869mm
528-9803445	3443mm
528-9804300	4298mm
528-9804500	4500mm

ALUMINIUMABDECKUNG ALUMINIUM COVER	LÄNGE LENGHT
528-27X3200	3200mm

COMPONENTS

90° VERBINDER 90° JUNCTION	LÄNGE LENGHT
581-01X	100mm

inkl. Aluminiumabdeckung
incl. aluminium cover

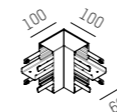

LINEARVERBINDER LINEAR JUNCTION	LÄNGE LENGHT
581-03	140mm

innenliegend
in board

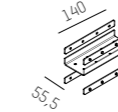

WANDMONTAGESSET WALL MOUNTING SET	LÄNGE LENGHT
581-109	140mm

Distanz: je 1000mm - 1 set
distance: every 1000mm - 1 set

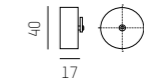

ABHÄNGUNG SUSPENSION	LÄNGE LENGHT
581-041X	max. 3000mm

Distanz: max. 800mm
distance: max. 800mm



BALDACHIN CANOPY	FARBE COLOUR
301-212000000400	grey
301-212000000500	white
301-212000000600	black

Einspeisekabel separat ordern
order power feed cable sepearly

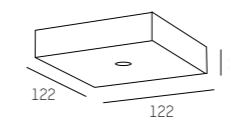

ERDUNGSSET EARTHING SET
581-05

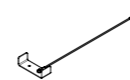

EINSPEISEKABEL POWER FEED CABLE	DIMENSION DIMENSION
301-k1547b2	3 x 0,75mm / L: 1750mm
301-k1547b1	3 x 0,75mm / L: 3150mm
301-k1627b2	3 x 1,50mm / L: 1750mm
301-k1627b1	3 x 1,50mm / L: 3150mm
301-k1787b2	5 x 0,75mm / L: 1750mm
301-k1787b1	5 x 0,75mm / L: 3150mm
301-k1867b2	5 x 1,50mm / L: 1750mm
301-k1867b1	5 x 1,50mm / L: 3150mm

Transparent, für Baldachin
inkl. Kabelbefestigungsringe
transparent, for canopy
incl. cable fixing rings



COMPLETE CODE FORPROFILE

X = COLOUR

W white = 5 **S** black = 6 **AE** alu anodized = 8



MORE THAN A TUBE

Unser schlichtes und zurückhaltendes 48V Lichtrohrsystem mit einem Durchmesser von nur 7cm schafft eine optimale Verbindung aus Grundlicht und Akzentuierung. Eine nicht sichtbar im opalen Kunststoffrohr eingelassene 48V Stromschiene bietet die Möglichkeit, die homogene Grundbeleuchtung der VALO optional mit Spots zu erweitern. Mit den 1-flammig sowie 2-flammig erhältlichen Strahlern lassen sich gekonnt Highlights im Raum in Szene setzen. Für ein hohes Maß an Flexibilität in der Lichtgestaltung sind die Strahlereinsätze frei in der Schiene platzierbar und lassen sich sowohl horizontal als auch vertikal schwenken.

Our simple and modest 48V light tube system with a diameter of only 7 cm perfectly combines basic lighting and accentuation. With the 48V track embedded invisibly in the opal plastic tube, it is possible to expand VALO's homogenous basic lighting optionally with spots. The spotlights, available in a one-lamp or two-lamp version, create individual accents in interior spaces. The fact that the spotlight inserts can be individually placed in the rail offers a high degree of flexibility for lighting design. On top of that, they can be swivelled horizontally as well as vertically.

Design: INHOUSE

VALO



Versions



Core Colours



Light beam

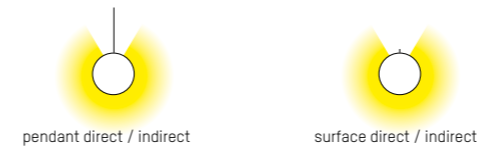

LED Colour



System inserts



Design: INHOUSE

Information VALO





VALO TRACK

220-240V AC 50/60Hz Design: INHOUSE

OPAL DIFFUSER

Zylindrische Stromschienenleuchte · sehr homogene Ausleuchtung · 230V Spannungsversorgung, ohne rückseitige 48V Stromschiene
 Pendant in cylindric shape · homogeneous lighting · 230V power supply, without rear 48V power rail
 Lampada a sospensione con struttura cilindrica · alimentazione 230V, senza barra di alimentazione 48V posteriore
 Lampe à suspension avec couvercle cylindrique · alimentation 230V, sans rail d'alimentation arrière 48V

SYS 26W L: 1146mm LM
 720-0083210WWXXY 2920 - 3000

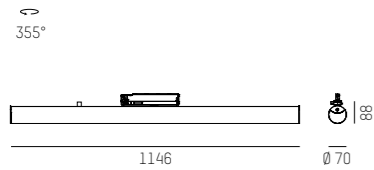

IP20 Ⓢ CE

COMPLETE CODE																			
WW = LIGHT COLOUR	XX = COLOUR	Y = DIMMBAR / DIMMABLE																	
<table border="1"> <tr> <td>W2</td> <td>LED 2700K = 23</td> <td>CRI>90</td> </tr> <tr> <td>W3</td> <td>LED 3000K = 29</td> <td>CRI>90</td> </tr> <tr> <td>W4</td> <td>LED 4000K = 24</td> <td>CRI>90</td> </tr> </table>	W2	LED 2700K = 23	CRI>90	W3	LED 3000K = 29	CRI>90	W4	LED 4000K = 24	CRI>90	<table border="1"> <tr> <td>W</td> <td>white = 55</td> </tr> </table>	W	white = 55	<table border="1"> <tr> <td>S</td> <td>switchable = 0</td> </tr> <tr> <td>P</td> <td>PULSE DALI dimm. = p</td> </tr> <tr> <td>B</td> <td>BLUETOOTH dimm. = b</td> </tr> </table>	S	switchable = 0	P	PULSE DALI dimm. = p	B	BLUETOOTH dimm. = b
W2	LED 2700K = 23	CRI>90																	
W3	LED 3000K = 29	CRI>90																	
W4	LED 4000K = 24	CRI>90																	
W	white = 55																		
S	switchable = 0																		
P	PULSE DALI dimm. = p																		
B	BLUETOOTH dimm. = b																		



VALO TRACK

For technical data and energy efficiency

Intersport Schneider
 Altenmarkt, Austria
 Photo: Joachim Rauch



VALO TRACK

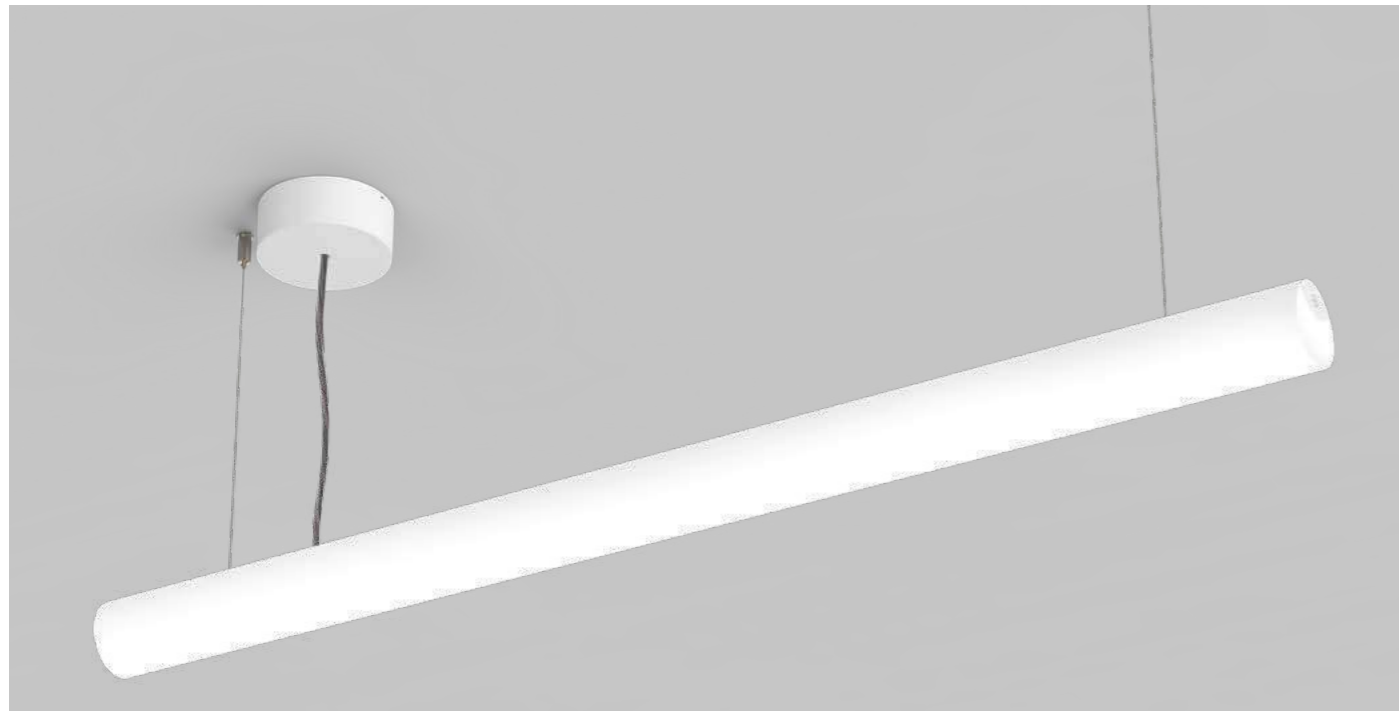

VALO HV PDI

220-240V AC 50/60Hz Design: INHOUSE

OPAL DIFFUSER

Zylindrische Pendelleuchte · sehr homogene Ausleuchtung · 230V Spannungsversorgung, ohne rückseitige 48V Stromschiene
 Pendant in cylindric shape · homogeneous lighting · 230V power supply, without rear 48V power rail
 Lampada a sospensione con struttura cilindrica · alimentazione 230V, senza barra di alimentazione 48V posteriore
 Lampe à suspension avec couvercle cylindrique · alimentation 230V, sans rail d'alimentation arrière 48V

SYS 26W L: 1146mm LM
 720-0073210WWXXY 2920 - 3000

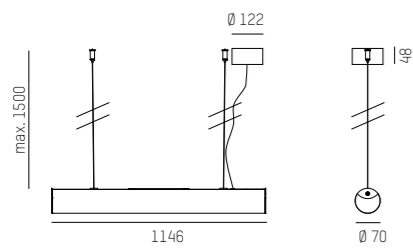

IP20 Ⓢ CE

COMPLETE CODE		
WW = LIGHT COLOUR	XX = COLOUR	Y = DIMMBAR / DIMMABLE
W2 LED 2700K = 23 CRI>90	W white = 55	S switchable = 0
W3 LED 3000K = 29 CRI>90		D DALI dimm. = d
W4 LED 4000K = 24 CRI>90		B BLUETOOTH dimm. = b

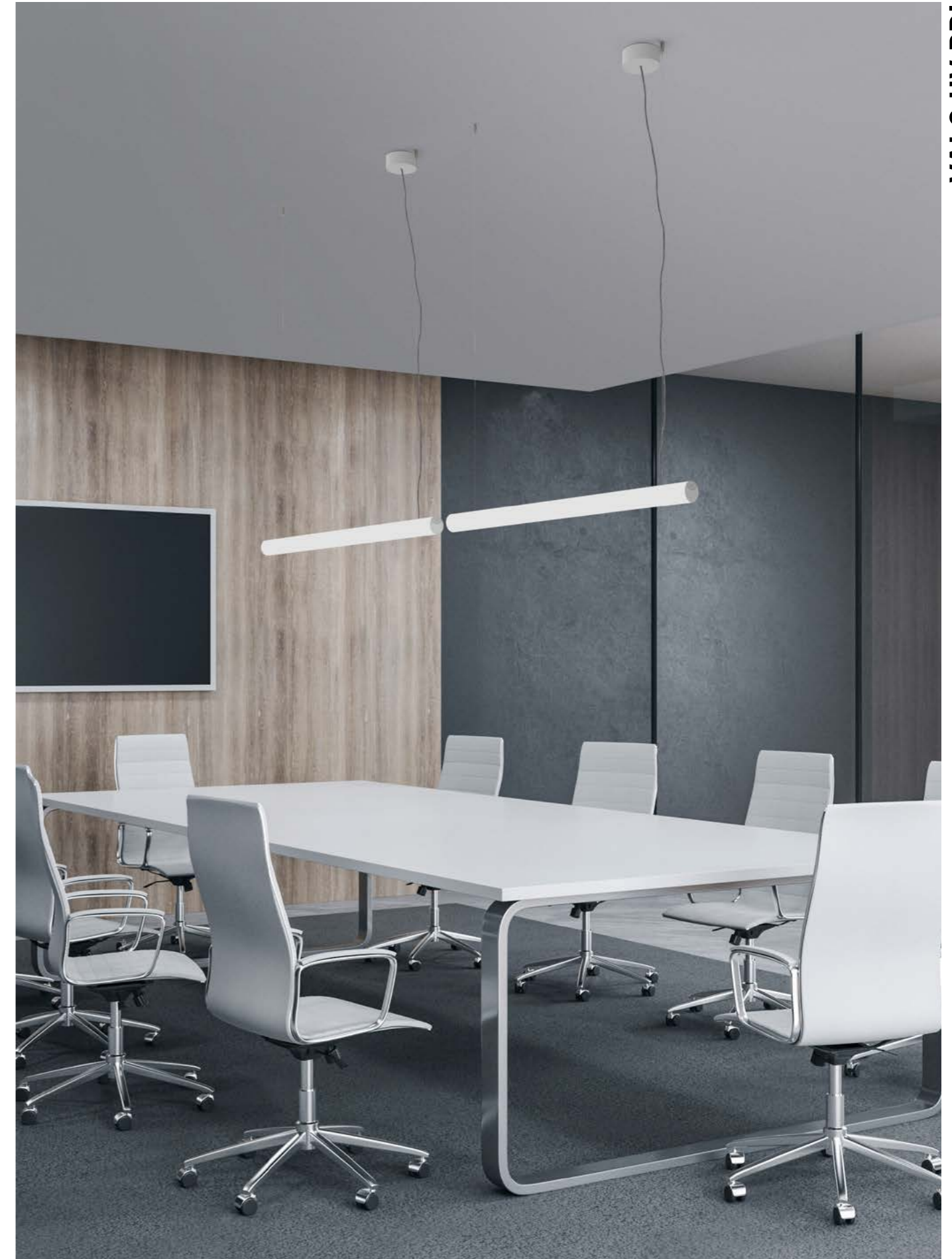

For technical data and energy efficiency



VALO PDI

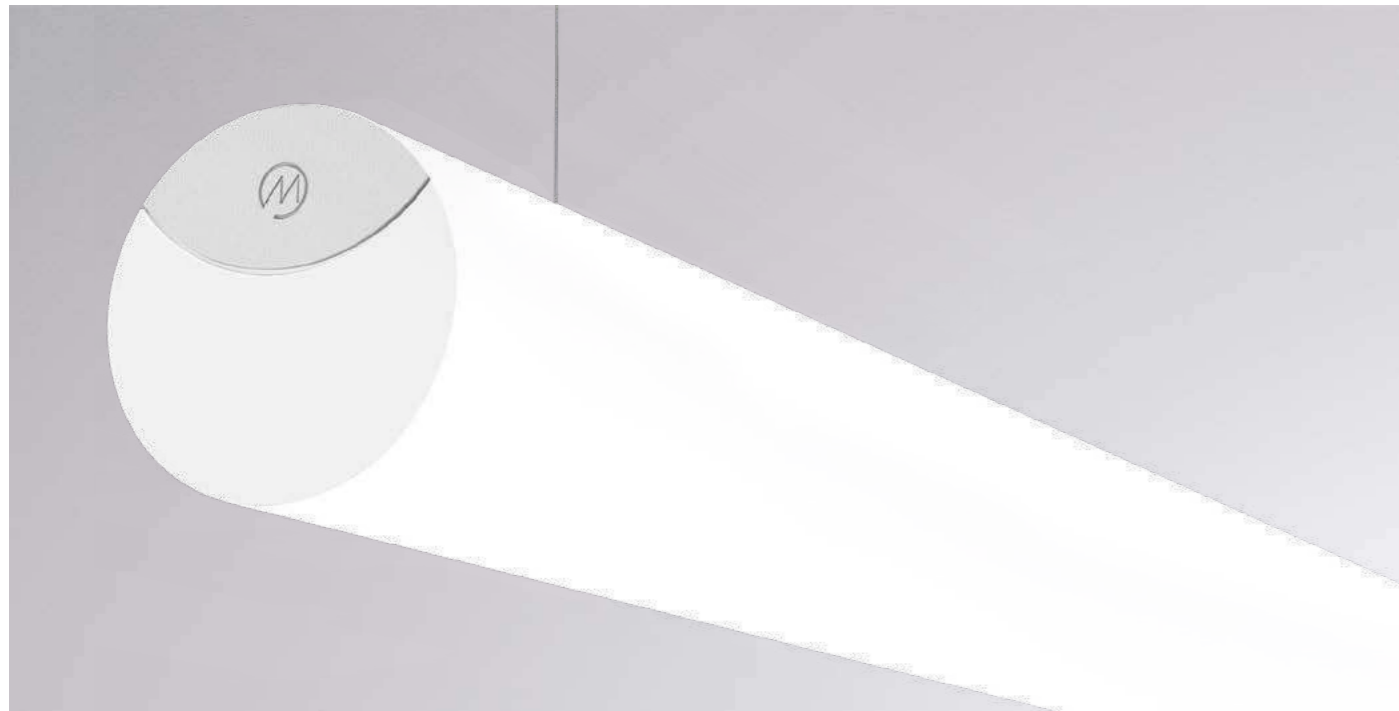

VALO PDI OPAL DIFFUSER

220-240V AC 50/60Hz Design: INHOUSE

Zylindrische Hängeleuchte · sehr homogene Ausleuchtung · deckenseitige 48V Stromschiene · 48V Konverter im Baldachin · Spot Einsätze nachrüstbar
 Pendant in cylindric shape · homogeneous lighting · 48V Track on the top side · 48V Driver included in canopy · spot insert can be edited
 Lampada a sospensione con struttura cilindrica · binario superiore da 48V · convertitore 48V nel rosone · inserti spot intercambiabili anche dopo l'installazione
 Lampe à suspension avec couvercle cylindrique · rail de plafond 48V · convertisseur 48V dans la verrière · les inserts spot pouvant être réaménagés

SYS 15W	L: 586mm	LM
720-0023110 WWXXY		1170 - 1290

SYS 60W	L: 2266mm	LM
720-0023410 WWXXY		4680 - 5170

SYS 30W	L: 1146mm	LM
720-0023210 WWXXY		2340 - 2580

SYS 90W	L: 3386mm	LM
720-0023510 WWXXY		7020 - 7750

SYS 45W	L: 1706mm	LM
720-0023310 WWXXY		3510 - 3870

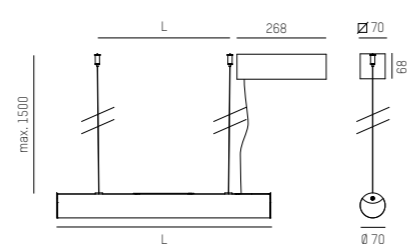
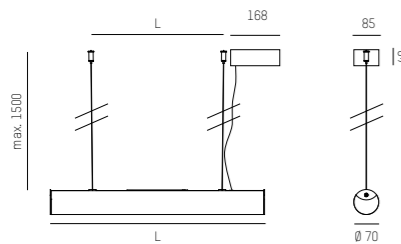

IP20

COMPLETE CODE		
WW = LIGHT COLOUR	XX = COLOUR	Y = DIMMBAR / DIMMABLE
W2 LED 2700K = 23 CRI>90	W white = 55	S switchable = 0
W3 LED 3000K = 29 CRI>90		D DALI dimm. = d
W4 LED 4000K = 24 CRI>90		B BLUETOOTH dimm. = b



Intersport Tscherne
 Salzburg, Austria
 Photo: Joachim Rauch



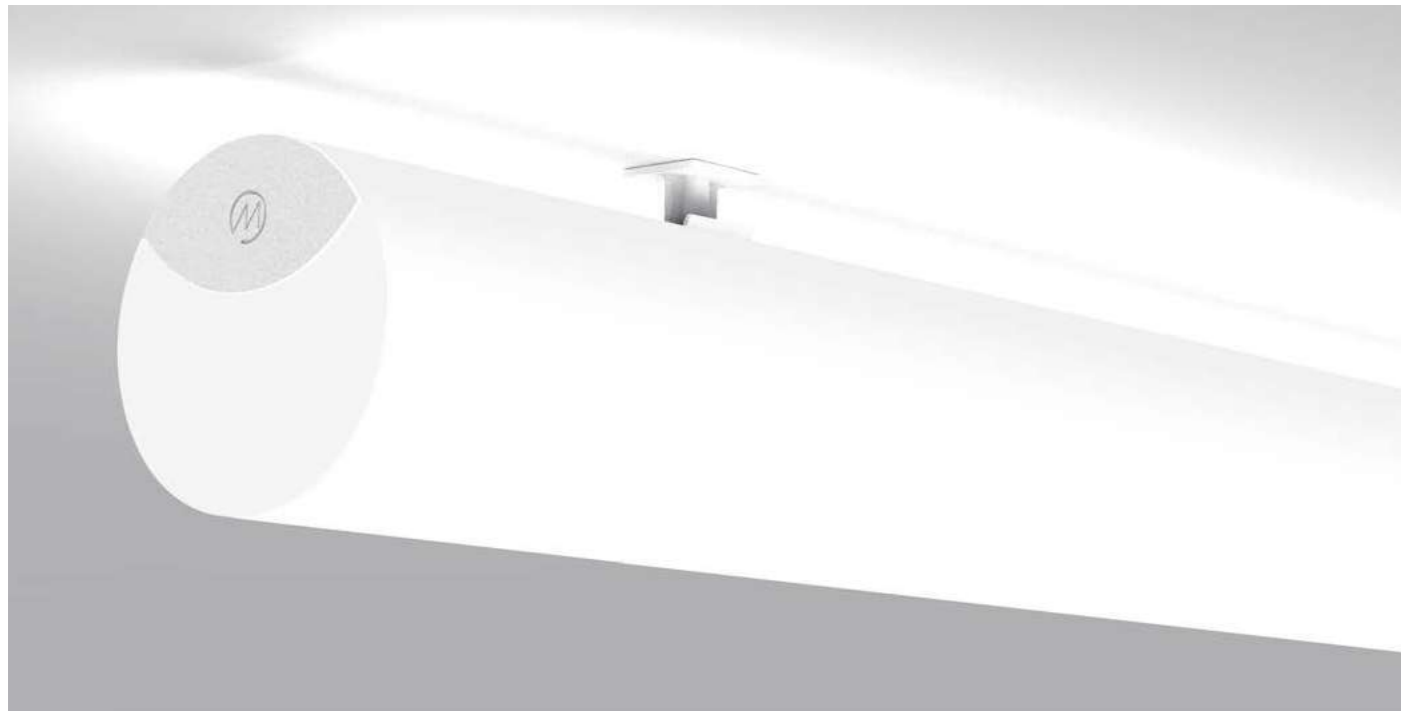

VALO SDI

220-240V AC 50/60Hz Design: INHOUSE

OPAL DIFFUSER

Zylindrische Wand- Deckenleuchte · sehr homogene Ausleuchtung · deckenseitige 48V Stromschiene · 48V Konverter im Baldachin
 Wall- Surface luminaries in cylindric shape · homogeneous lighting · 48V Track on the top side · 48V Driver included in canopy
 Lampada da parete / soffitto con struttura cilindrica · binario superiore da 48V · convertitore 48V nel rosone intercambiabili anche dopo l'installazione
 Lampe de plafond / murale avec couvercle cylindrique · rail de plafond 48V · convertisseur 48V dans la verrière pouvant être réaménagés

SYS 15W	L: 586mm	LM
720-0033110 WWXXY		1170 - 1290

SYS 60W	L: 2266mm	LM
720-0033410 WWXXY		4680 - 5170

SYS 30W	L: 1146mm	LM
720-0033210 WWXXY		2340 - 2580

SYS 90W	L: 3386mm	LM
720-0033510 WWXXY		7020 - 7750

SYS 45W	L: 1706mm	LM
720-0033310 WWXXY		3510 - 3870

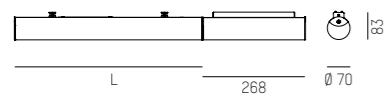

IP20

COMPLETE CODE		
WW = LIGHT COLOUR	XX = COLOUR	Y = DIMMBAR / DIMMABLE
LED 2700K = 23 CRI>90	white = 55	switchable = 0
LED 3000K = 29 CRI>90		DALI dimm. = d
LED 4000K = 24 CRI>90		BLUETOOTH dimm. = b

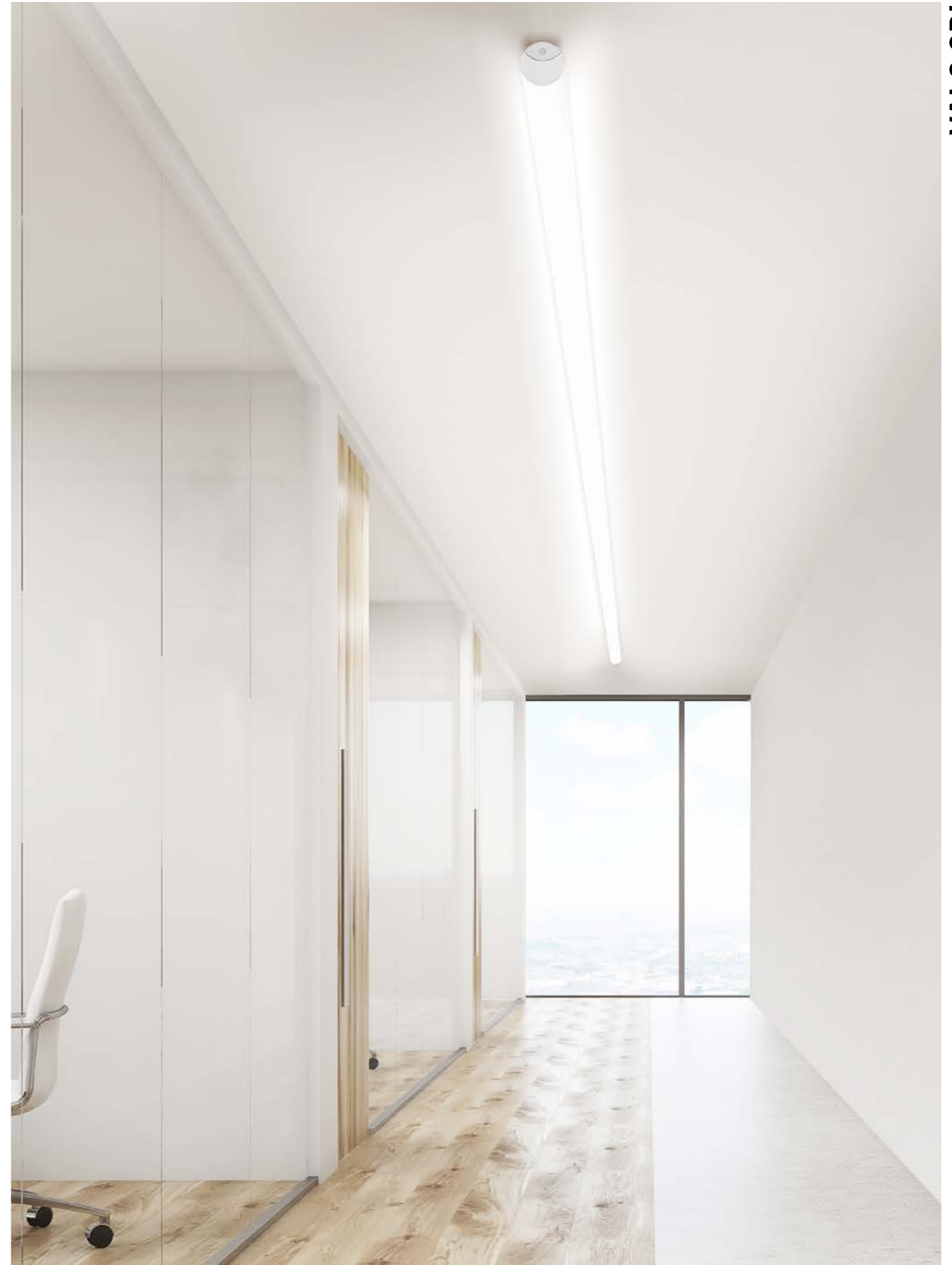

VALO SDI

For technical data and energy efficiency



VALO SDI

VALO SYSTEM TUBE

48V DC 50/60Hz

Zylindrische Systemleuchte · deckenseitige 48V Stromschiene · Spot Einsätze an jeder Stelle einsetzbar · Systemzubehör separat ordernt
System luminaries in cylindric shape · 48V Track on the top side · spot insert can be edited · order system accessories separately
Lampada da sistema con struttura cilindrica · binario superiore da 48V · inserti spot inseribili in qualsiasi punto · accessori da ordinare separatamente
Lampe système avec couvercle cylindrique · voie de plafond 48V · les inserts spot peuvent être utilisés partout · commandez les accessoires séparément

SYS 12W	L: 586mm	LM	SYS 24W	L: 1146mm	LM	SYS 36W	L: 1706mm	LM
720-0013110WWXXY		1170 - 1290	720-0013210WWXXY		2340 - 2580	720-0013310WWXXY		3510 - 3870

SYS 48W	L: 2266mm	LM	SYS 72W	L: 3386mm	LM
720-0013410WWXXY		4680 - 5170	720-0013510WWXXY		7020 - 7750



ENDECKELSET - 2 Stk. END PIECE SET - 2 pcs.	FARBE COLOUR
720-001180000050	white

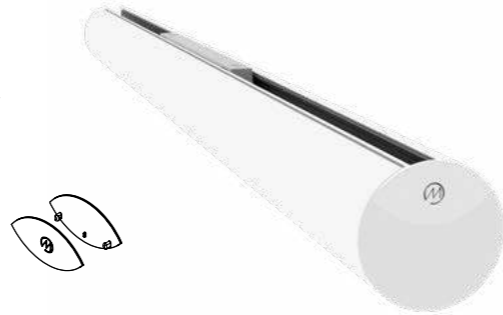

IP20 CE

COMPLETE CODE		
WW = LIGHT COLOUR	XX = COLOUR	Y = DIMMBAR / DIMMABLE
W2 LED 2700K = 23 CRI>90	W white = 55	S switchable = 0
W3 LED 3000K = 29 CRI>90		D DALI dimm. = d
W4 LED 4000K = 24 CRI>90		B BLUETOOTH dimm. = b

VALO SYSTEM SPOT

48V DC 50/60Hz

SINGLE / DOUBLE SPOT

System Spot Einsatz · 1- und 2- flammige Version · schaltbar, DALI oder Smart Bluetooth dimmbar · Oberfläche pulverbeschichtet
System Spot insert · 1- and 2- spot version · switchable, DALI or Smart Bluetooth dimmable · surface powder-coated
Proiettore da sistema · versione ad 1 o 2 spot · on/off, DALI o dimmerabile Smart Bluetooth · superficie verniciata a polveri
Encart pour spot sur le système · version spot 1 ou 2 · on/off, DALI- ou Smart Bluetooth dimmable · surface lacquée en poudre

VALO SYSTEM SPOT 1-FLAME

SYS 7W	L: 170mm	LM
720-004410RWWXXY		600 - 730

SYS 7W	L: 170mm	LM
720-004410RWWXXY		600 - 730

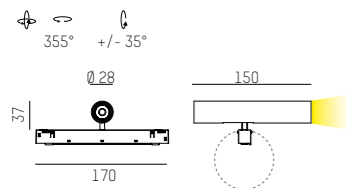

VALO SYSTEM SPOT 2-FLAME

SYS 14W	L: 170mm	LM
720-004420RWWXXY		2x 600 - 2x 730

SYS 14W	L: 170mm	LM
720-004420RWWXXY		2x 600 - 2x 730

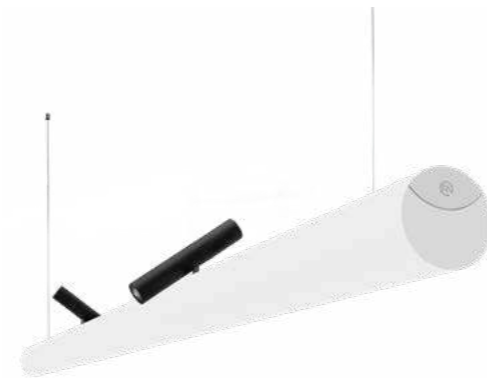
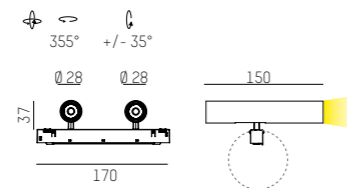

IP20 CE

COMPLETE CODE			
R = REFLECTOR	WW = LIGHT COLOUR	XX = COLOUR	Y = DIMMBAR / DIMMABLE
R 24° spot = 1	W2 LED 2700K = 43 PREMIUM CRI>90	W white = 55	S switchable = 0
R 38° flood = 3	W3 LED 3000K = 49 PREMIUM CRI>90	S black = 66	D DALI dimm. = d
	W4 LED 4000K = 24 CRI>90		B BLUETOOTH dimm. = b (only single spot)

COMPONENTS

ENDEINSPEISUNG PDI END POWER FEED PDI	FARBE COLOUR
720-001230000050	white

Für Pendelsysteme
inkl. 48V Konverter max. 150W
for system pendant mounting
incl. 48V driver max. 150W

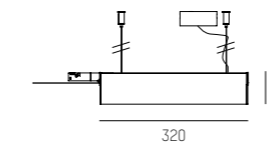

ENDEINSPEISUNG SDI END POWER FEED SDI	FARBE COLOUR
720-001080000050	white

Für Wand-/ Deckensysteme
inkl. 48V Konverter max. 150W
for system wall ceiling mounting
incl. 48V driver max. 150W

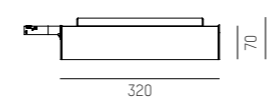

BALDACHIN AUFBAU CANOPY SURFACE	FARBE COLOUR	LEISTUNG POWER
720-001210000550	white	max. 70W
720-001210000660	black	max. 70W
720-001160000550	white	max. 150W
720-001160000660	black	max. 150W

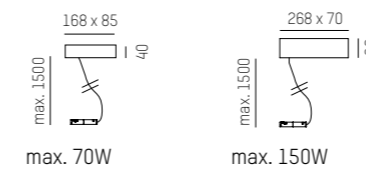

LINEARVERBINDER LINEAR JUNCTION	FARBE COLOUR
720-001020000050	white

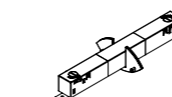

WANDMONTAGESSET WALL MOUNTING SET	FARBE COLOUR
720-001250000000	white

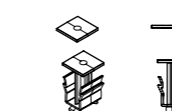

MITTELSPEISUNG PDI CENTER POWER FEED PDI	FARBE COLOUR
720-001240000050	white

Für Pendelsysteme
inkl. 48V Konverter max. 150W
for system pendant mounting
incl. 48V driver max. 150W

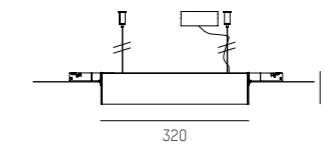

MITTELSPEISUNG SDI CENTER POWER FEED SDI	FARBE COLOUR
720-001090000050	white

Für Wand-/ Deckensysteme
inkl. 48V Konverter max. 150W
for system wall ceiling mounting
incl. 48V driver max. 150W

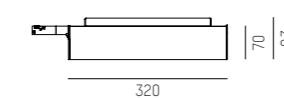

BALDACHIN EINBAU CANOPY RECESSED	FARBE COLOUR	LEISTUNG POWER
720-001170000550	white	max. 150W
720-001170000660	black	max. 150W

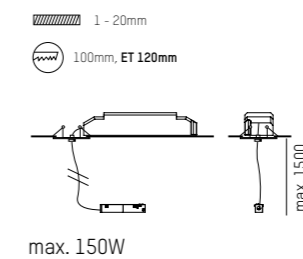

FLEXVERBINDER FLEXIBLE JUNCTION	FARBE COLOUR
720-001040000050	white

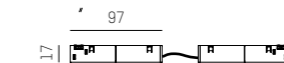

DECKENMONTAGESSET CEILING MOUNTING SET	FARBE COLOUR
720-001070000000	white



ABHÄNGUNG SUSPENSION	LÄNGE LENGHT
720-001050000000	max. 1500mm
720-001060000000	max. 4500mm



INDIREKTABDECKUNG WEISS INDIRECT COVER WHITE	LÄNGE LENGTH
720-001110000000	586mm
720-001120000000	1146mm
720-001130000000	1706mm
720-001140000000	2266mm
720-001150000000	3386mm
720-001220000000	per meter



DEMONTAGWERKZEUG

DEMOUNTING TOOL
720-001010000000
für Wand-/ Deckenleuchten
for wall- ceiling luminaires

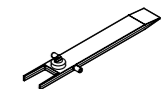

VALO SYSTEM TUBE VALO SYSTEM SPOT 1 FLAME VALO SYSTEM SPOT 2 FLAME



THE LINE SD

220-240V AC/DC 50/60Hz Design: INHOUSE

Aufbauleuchte aus stranggepresstem Aluminiumprofil · Enddeckel grau pulverbeschichtet · zweiseitig abstrahlende opale PMMA Abdeckung
 Surface luminaire made of extruded aluminium · end pieces grey powder coated · light emission on 2 sides, PMMA diffuser
 Plafone o da parete in alluminio estruso · tappi finali verniciati in polvere grigio · diffusore opale in PMMA, biemissione
 Plafonnier ou à paroi en aluminium extrudé · emboutes de fermeture vernissés a poudres gris · diffuseur opale en PMMA

SYS 17W	L: 601mm	LM	SYS 34W	L: 1163mm	LM	SYS 51W	L: 1731mm	LM
536-211 WW 8		1820 - 1910	536-212 WW 8		3640 - 3820	536-213 WW 8		5460 - 5730
SYS 68W	L: 2293mm	LM	SYS 85W	L: 2861mm	LM	SYS 102W	L: 3423mm	LM
536-214 WW 8		7280 - 7640	536-215 WW 8		9100 - 9550	536-216 WW 8		10920 - 11460
SYS 119W	L: 3991mm	LM	SYS 136W	L: 4553mm	LM			
536-217 WW 8		12740 - 13370	536-218 WW 8		14560 - 15280			

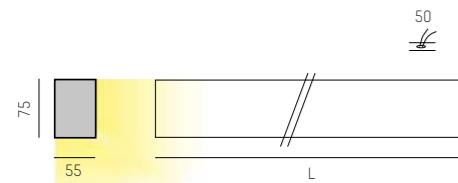

Sonderlängen auf Anfrage
 custom lenght upon request

IP20

COMPLETE CODE	
WW = LIGHT COLOUR	Y = DIMMABLE
W3 LED 3000K = 19 CRI>80	switchable = no addition
W4 LED 4000K = 14 CRI>80	DALI dimm. = code + ddd

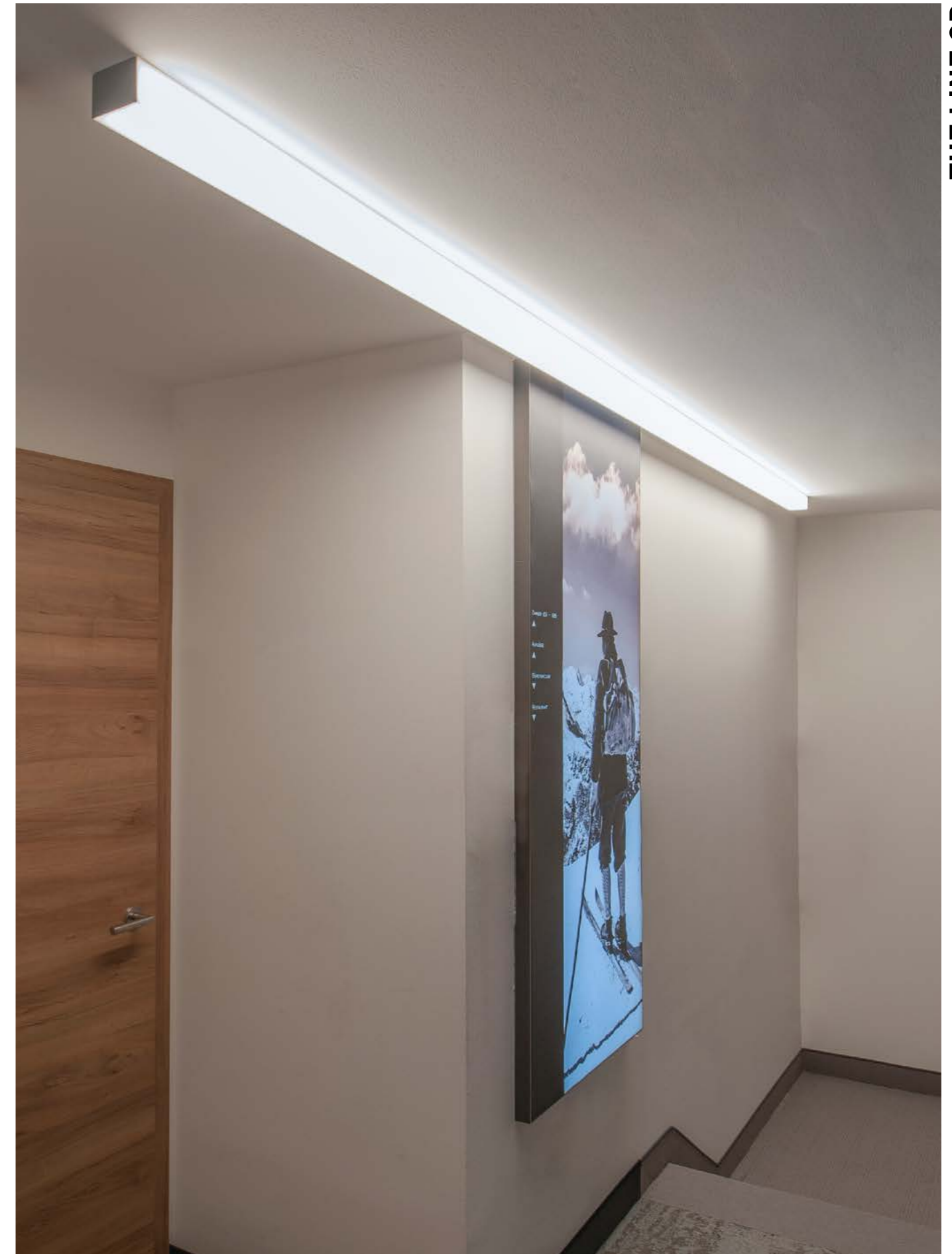

Technical data and energy efficiency

Hotel Christoph
 Ellmau, Austria
 Photo: Joachim Rauch



PROFILE

PROFIL SYSTEM PROFILE SYSTEM	LÄNGE LENGTH
536-22000	4600mm
536-22018	per running meter

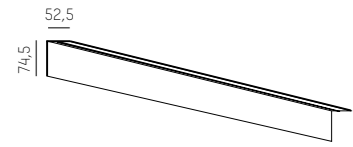

PMMA ABDECKUNG OPAL PMMA COVER OPAL	LÄNGE LENGTH
536-23001	4600mm
536-23010	per running meter

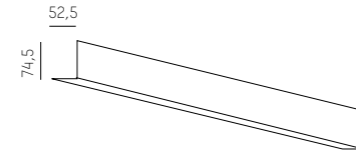

ACHTUNG: Abdeckung, Lichteinsätze und Systemteile separat ordern
ATTENTION: order covers, light inserts and components separately

LIGHT INSERTS

Einspeisung durchgangsverdrahtet 1,5mm², rsteckfertig, inkl. Verbindungskabel, Achtung: Lumenwerte inkl. Abdeckung
Feed through wired 1,5mm², ready to plug in, incl. connector cable, Attention: Lumendata are with cover

LOW OUTPUT

SYS 17W	L: 567mm	LM
536-241WW		1820 - 1910

SYS 34W	L: 1129mm	LM
536-242WW		3640 - 3820

HIGH OUTPUT

SYS 23W	L: 567mm	LM
536-241WWh		2290 - 2400

SYS 45W	L: 1129mm	LM
536-242WWh		4580 - 4800

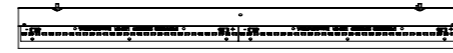

COMPLETE CODE	
WW = LIGHT COLOUR	Y = DIMMABLE
W3 LED 3000K = 19 CRI>80	S switchable = no addition
W4 LED 4000K = 14 CRI>80	D DALI dimm. = code + ddd

COMPONENTS

EINSPEISUNG POWER FEED	KABEL CABLE
536-270	3 x 0,75mm ²
536-270d	5 x 0,75mm ²

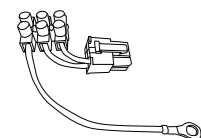

ENDECKELSET END PIECE SET	FARBE COLOUR
536-268	6

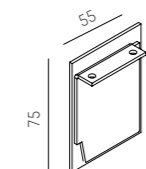

Set 2 Stk. inkl. Erdungskabel
set 2 pcs. incl. ground cable

LINEARVERBINDER LINEAR JUNCTION
536-258

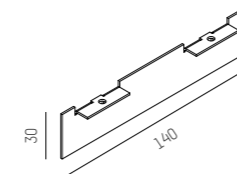

THE LINE SYSTEM



Private residence
Austria
Photo: Joachim Rauch

Technical data and energy efficiency



THE LINE SYSTEM



THE NEXT GENERATION OF OFFICE LUMINAIRES

CONCEPT ist die erste auf dem Markt erhältliche Büroleuchte, welche stirnseitig angebracht wird und ohne Überhang den kompletten Arbeitsplatz normkonform (EN 12464-1) und mit höchster Homogenität ausleuchtet. Die minimalistisch anmutende Leuchtenserie wurde speziell für die hohen Anforderungen einer effizienten Lichtstimmung moderner Einzel- sowie Doppelarbeitsplätze entwickelt. Durch die separate Steuerung lässt sich nur jener Bereich ausleuchten, welcher gerade benötigt wird und ermöglicht so eine besonders nachhaltige und energiesparende Beleuchtungslösung.

CONCEPT is the first office luminaire available on the market which is attached on the front side and still offers standard-compliant illumination (EN 12464-1) of the complete workstation with highest homogeneity without overhang. The luminaire series with minimalist appearance was developed especially for the high requirements on efficient light atmosphere of modern single and double workstations. The separate control makes it possible to illuminate only required areas with an especially sustainable and energy-saving illumination as a result.

Design: INHOUSE

CONCEPT



Versions

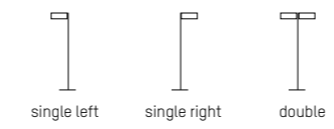

Core Colours



Creative Colours

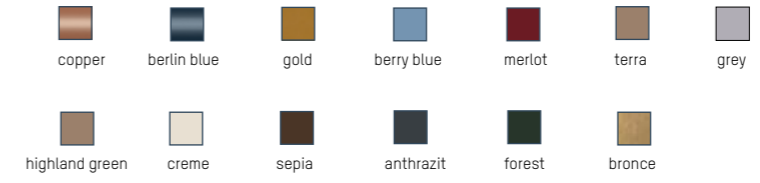

LED Colour



Special



place frontside to the workstation

Design: INHOUSE

Information CONCEPT



BACK TO CONTENT



CONCEPT LEFT F / CONCEPT RIGHT F

220-240V AC 50/60Hz CRI>80 Design: INHOUSE

LED Stehleuchte aus Aluminium · Oberfläche pulverbeschichtet · Freiformflächenreflektorm für Einzelarbeitsplatz · Platzierung links bzw. rechts von Arbeitsplatz · mit Tageslichtsensor, Bewegungsmelder und Schwarm-funktion

LED floor lamp in aluminium · surface powder-coated · free-form surface reflector for single workstation · placement left or right of workstation · with daylight control, motion detector and wireless swarm network-function

Piantana led ad ingombro ridotto in alluminio · superficie verniciata a polveri · riflettore a forma libera per postazione di lavoro singola · posizionamento sinistro o destro sul luogo di lavoro · sensore di movimento, rilevatore di luminosità e funzione di rete wireless

Lampadaire LED en aluminium · surface lacquée en poudre · réflecteur uniforme pour poste de travail individuel · positionnement à gauche ou à droite du plan de travail · Détecteur de mouvement, capteur de lumière et fonction réseau sans fil

CONCEPT LEFT F

SYS 70W	UGR<16	LM
723-0011101	WWXXY	7400 - 7710

Links am Schreibtisch platzieren
Place left of workstation

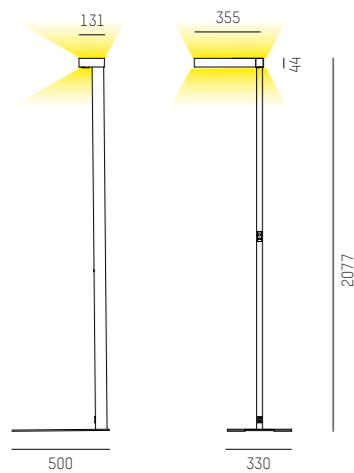

CONCEPT RIGHT F

SYS 70W	UGR<16	LM
723-0011201	WWXXY	7400 - 7710

Rechts am Schreibtisch platzieren
Place right of workstation

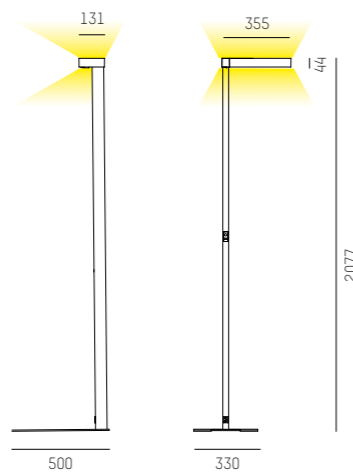

PUSH BUTTON MOTION SWARM

646-000040000050 **W** ON / OFF & Dimm

646-000040000060 **S** ON / OFF & Dimm

Optionaler radio push-button
Optional radio push-button

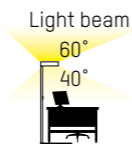
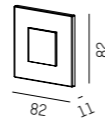

IP20

COMPLETE CODE		
WW = LICHTFARBE / LIGHT COLOUR	XX = FARBE / COLOUR	Y = DIMMBAR / DIMMABLE
W3 LED 3000K = 19	W white = 55	S switchable = 0
W4 LED 4000K = 14	S black = 66	MS motion swarm = m (without foil button)
		T push-button dimm. = t
		K motion daylight = k

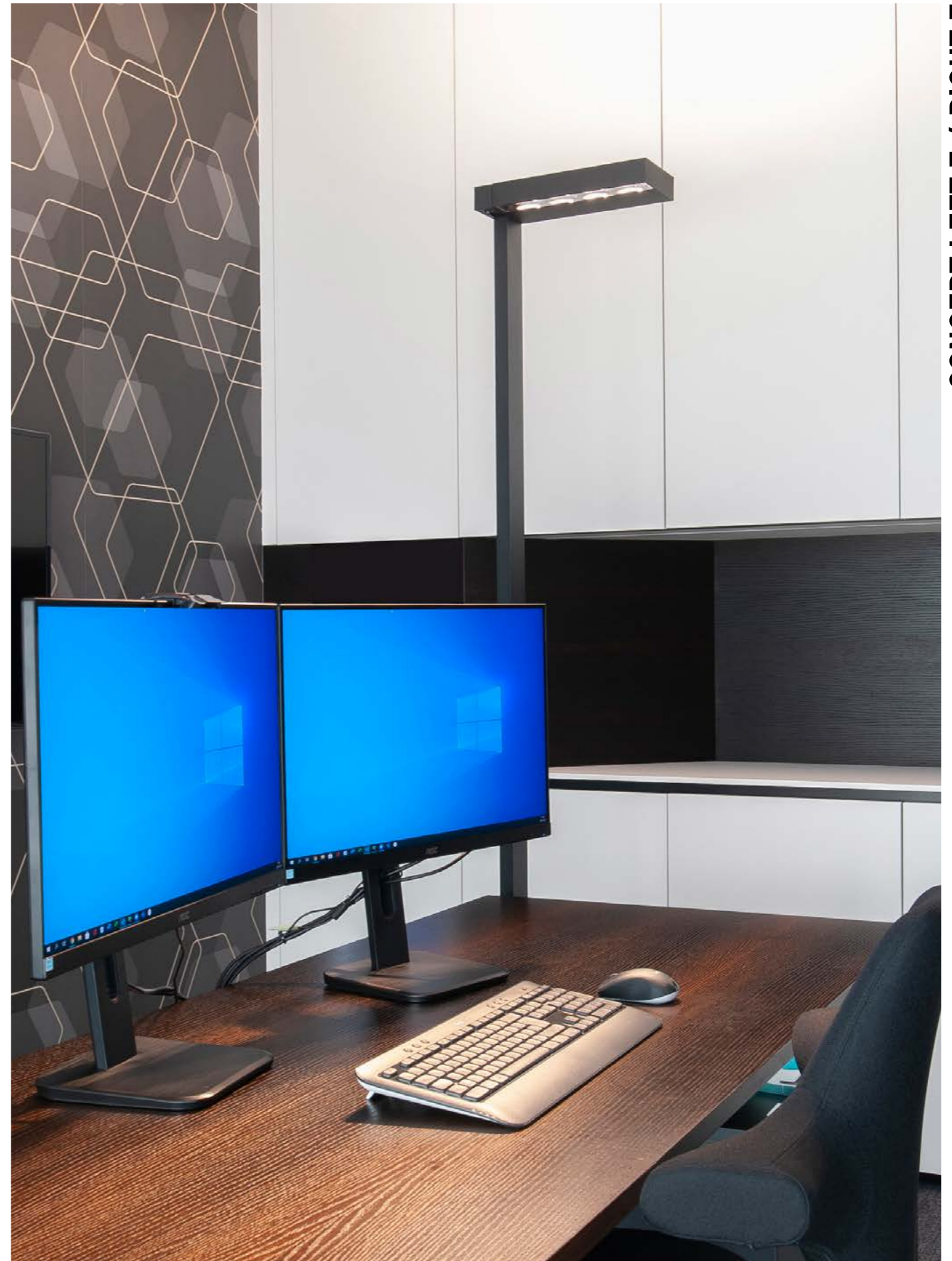

CONCEPT LEFT F / RIGHT F

Private residence
Unterweisersdorf, Austria
Leibets Interior Design
Photo: Joachim Rauch

Technical data and energy efficiency



CONCEPT LEFT F



CONCEPT RIGHT F



CONCEPT DOUBLE F

220-240V AC 50/60Hz CRI>80 Design: INHOUSE

LED Stehleuchte aus Aluminium · Oberfläche pulverbeschichtet · Freiformflächenreflektor für Doppelarbeitsplatz · mit Tageslichtsensor, Bewegungsmelder und Schwarm-funktion

LED floor lamp in aluminium · surface powder-coated · free-form surface reflector for double workstation · with daylight control, motion detector and wireless swarm network-function

Piantana led ad ingombro ridotto in alluminio · superficie verniciata a polveri · riflettore a forma libera per postazione di lavoro doppia · sensore di movimento, rilevatore di luminosità e funzione di rete wireless

Lampadaire LED en aluminium · surface laquée en poudre · réflecteur uniforme pour poste de travail individuel · réflecteur uniforme pour poste de travail double · Détecteur de mouvement, capteur de lumière et fonction réseau sans fil

CONCEPT DOUBLE F

SYS 140W	UGR<16	LM
723-0011303WWXXY		14800 - 15420
In der Mitte von 2 Schreibtischen platzieren Place in center of two workstations		

PUSH BUTTON MOTION SWARM

646-000040000050	W	ON / OFF & Dimm
646-000040000060	S	ON / OFF & Dimm
Optionaler radio push-button Optional radio push-button		

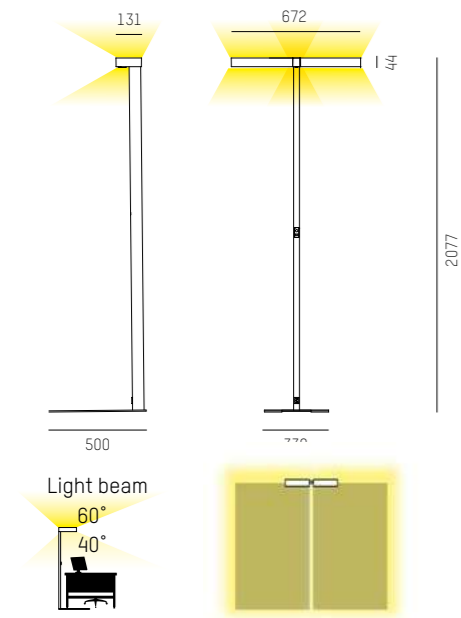
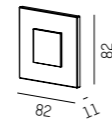

IP20 Ⓢ CE



COMPLETE CODE		
WW = LICHTFARBE / LIGHT COLOUR	XX = FARBE / COLOUR	Y = DIMMBAR / DIMMABLE
W3 LED 3000K = 19	W white = 55	S switchable = 0
W4 LED 4000K = 14	S black = 66	MS motion swarm = m (without foil button)
		T push-button dimm. = t
		K motion daylight = k

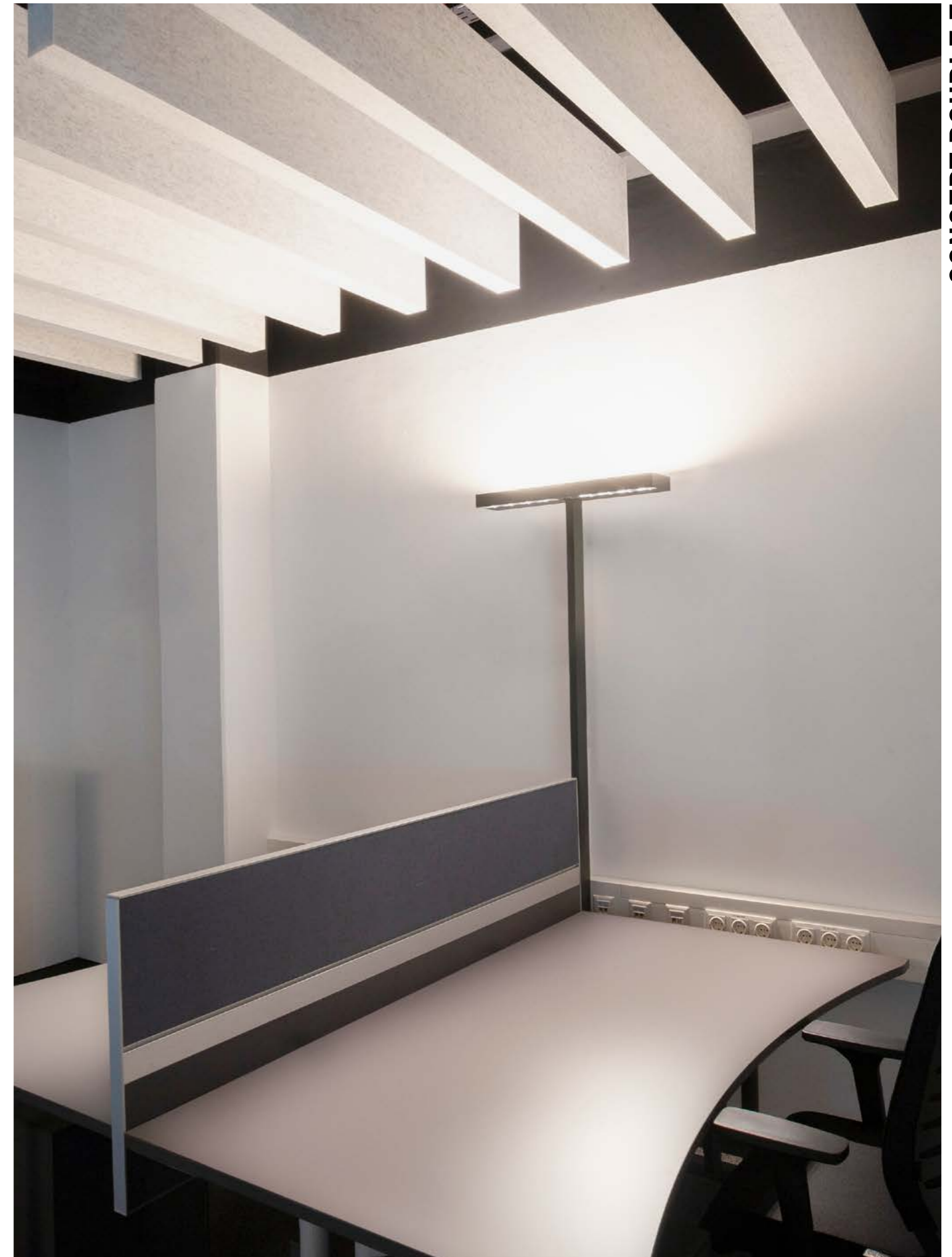

Technical data and energy efficiency



CONCEPT DOUBLE F

Molto Luce
Weißkirchen, Austria
Photo: Joachim Rauch

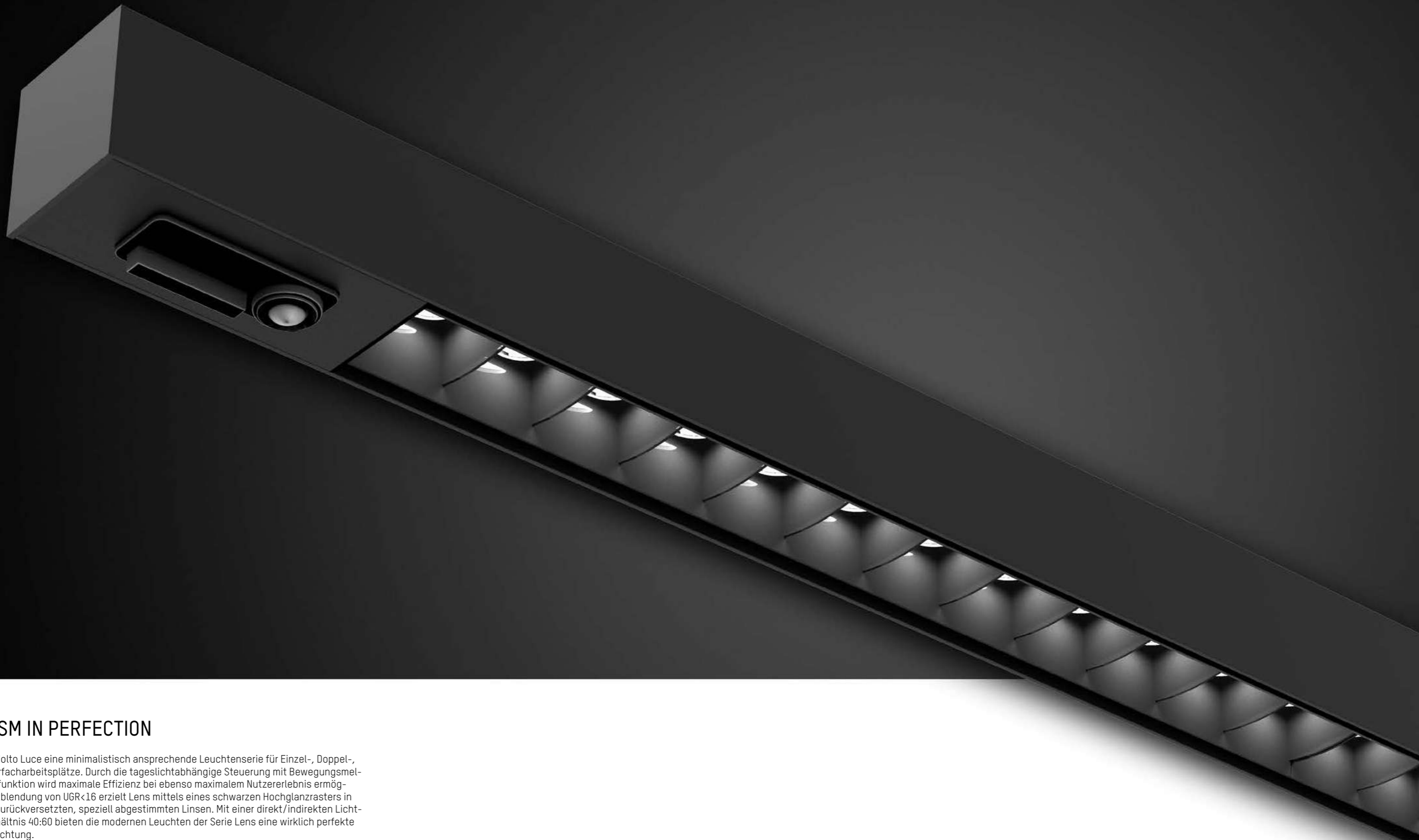

MINIMALISM IN PERFECTION

Mit Lens gelingt Molto Luce eine minimalistisch ansprechende Leuchtenserie für Einzel-, Doppel-, Dreifach- und Vierfcharbeitsplätze. Durch die tageslichtabhängige Steuerung mit Bewegungsmelder und Schwarmfunktion wird maximale Effizienz bei ebenso maximalem Nutzererlebnis ermöglicht. Perfekte Entblendung von UGR<16 erzielt Lens mittels eines schwarzen Hochglanzrasters in Kombination mit zurückversetzten, speziell abgestimmten Linsen. Mit einer direkt/indirekten Lichtverteilung im Verhältnis 40:60 bieten die modernen Leuchten der Serie Lens eine wirklich perfekte Arbeitsplatzbeleuchtung.

With Lens, Molto Luce has succeeded in creating an attractive minimalist luminaire range for single, double, triple and quad workstations. The daylight-dependent controls, with a motion sensor and swarm function not only provide maximum efficiency, but a maximum user experience as well. Lens achieves a perfect glare suppression with an UGR of <16, by means of a black high gloss louvre, combined with specially coordinated downward lenses. With a direct / indirect light distribution in a 40:60 ratio the contemporary luminaires of the Lens range offer absolutely perfect workstation illumination.

Design: INHOUSE

LENS



Versions



single/double pendant

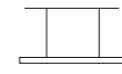

quad pendant



single/double floor



triple floor

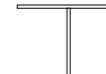

quad floor



single/double short pendant

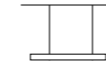

quad short pendant



single/double short floor



quad short floor

Core Colours



white



black



alu anodized

Creative Colours



copper



berlin blue



gold



berry blue



merlot



terra



highland green



creme



sepia



anthrazit



forest



bronze

LED Colour



3000K



4000K

Special



minimum glare / UGR<16





LENS F

220-240V AC 50/60Hz CRI>80 Design: INHOUSE

Superschlank LED Stehleuchte aus Aluminium · Oberfläche pulverbeschichtet oder eloxiert · Linsen mit Einzel- oder Doppelarbeitsplatz Optik · perfekte Entblendung durch schwarzen Hochglanzraster · mit Tageslichtsensor, Bewegungsmelder und Schwarmfunktion

Super-slim LED floor lamp in aluminium · surface powder-coated or anodized · recessed lens with single or double workstation optic · perfect anti-glare due to black high-gloss grid · daylight control, motion detector and wireless swarm network-function

Piantana a LED a ingombro ridotto in alluminio · superficie verniciata a polveri o anodizzata · lente retrocessa con ottica singola o doppia · anti-abbagliamento garantito da una griglia nera lucida · sensore di movimento e rilevatore quantità di luce e wireless funzione di rete

Lampadaire extra-fin à LED en aluminium · surface lacquée en poudre ou anodisée · optique à émission simple ou double · grille basse-luminance · détecteur de mouvement, capteur de lumière et fonction réseau sans fil.

LENS SINGLE F

SYS 53W	UGR<16	LM
646-1026103WWXXY		6100

In der Mitte eines Arbeitsplatzes platzieren
Place in center of one workstation

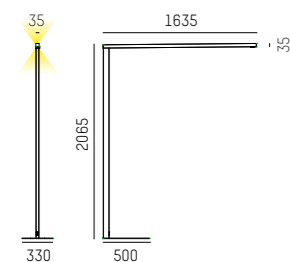

Light beam

60°

40°

IP20 CE

LENS DOUBLE F

SYS 111W	UGR<16	LM
646-1026205WWXXY		11480

In der Mitte von zwei Arbeitsplätzen platzieren
Place in center of two workstations

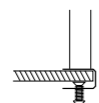
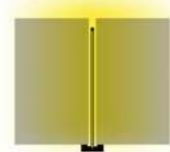
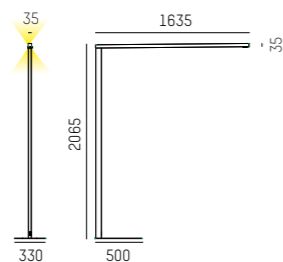

Table mounted version on request

PUSH BUTTON MOTION SWARM

646-000040000050	W	ON / OFF & Dimm
-------------------------	----------	-----------------

646-000040000060	S	ON / OFF & Dimm
-------------------------	----------	-----------------

Optionaler radio push-button
Optional radio push-button

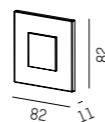

COMPLETE CODE																											
G = PUSH BUTTON	WW = LIGHT COLOUR	XX = COLOUR	Y = DIMMABLE																								
<table border="1"> <tr> <td></td> <td>push button = 0</td> </tr> <tr> <td></td> <td>foil button = 1</td> </tr> <tr> <td></td> <td>motion swarm = 0</td> </tr> </table>		push button = 0		foil button = 1		motion swarm = 0	<table border="1"> <tr> <td>W3</td> <td>LED 3000K = 29</td> </tr> <tr> <td>W4</td> <td>LED 4000K = 24</td> </tr> </table>	W3	LED 3000K = 29	W4	LED 4000K = 24	<table border="1"> <tr> <td>W</td> <td>white = 05</td> </tr> <tr> <td>S</td> <td>black = 06</td> </tr> <tr> <td>AE</td> <td>aluminium anodized = 08</td> </tr> </table>	W	white = 05	S	black = 06	AE	aluminium anodized = 08	<table border="1"> <tr> <td>S</td> <td>switchable = 0</td> </tr> <tr> <td>MS</td> <td>motion swarm = m (without foil or push button)</td> </tr> <tr> <td>T</td> <td>push-button dimm. = t</td> </tr> <tr> <td>K</td> <td>motion daylight = k</td> </tr> </table>	S	switchable = 0	MS	motion swarm = m (without foil or push button)	T	push-button dimm. = t	K	motion daylight = k
	push button = 0																										
	foil button = 1																										
	motion swarm = 0																										
W3	LED 3000K = 29																										
W4	LED 4000K = 24																										
W	white = 05																										
S	black = 06																										
AE	aluminium anodized = 08																										
S	switchable = 0																										
MS	motion swarm = m (without foil or push button)																										
T	push-button dimm. = t																										
K	motion daylight = k																										

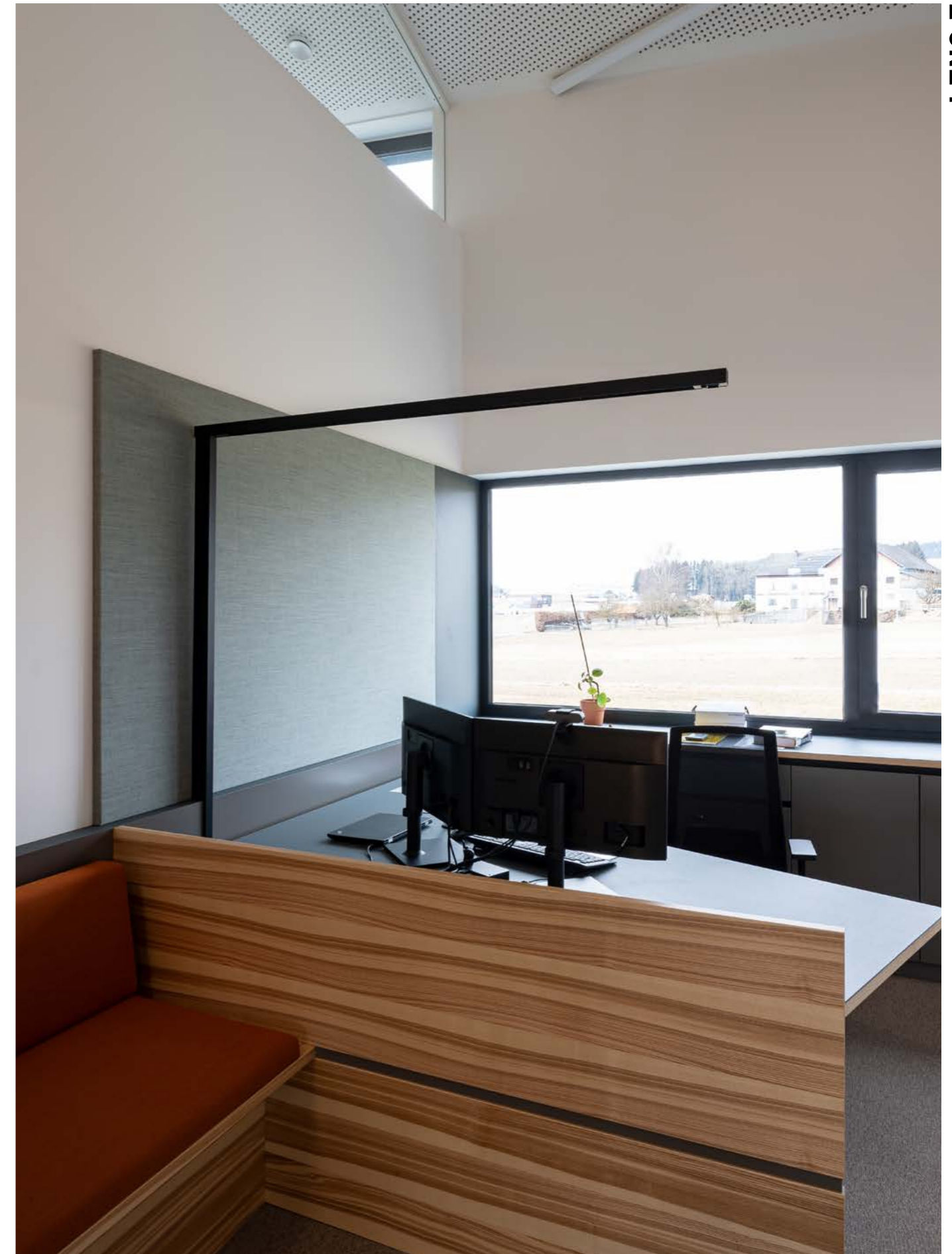

Nordfels
Bad Leonfelden, Austria
Photo: Joachim Rauch

Technical data and energy efficiency



LENS SINGLE F



LENS DOUBLE F



LENS F

220-240V AC 50/60Hz CRI>80 Design: INHOUSE

Superschlank LED Stehleuchte aus Aluminium · Oberfläche pulverbeschichtet oder eloxiert · Linsen mit Triple- oder Quadarbeitsplatz Optik · perfekte Entblendung durch schwarzen Hochglanzraster · mit Tageslichtsensor, Bewegungsmelder und Schwarmfunktion

Super-slim LED floor lamp in aluminium · surface powder-coated or anodized · recessed lens with triple or quad workstation optic · perfect anti-glare due to black high-gloss grid · daylight control, motion detector and wireless swarm network-function

Piantana a LED a ingombro ridotto in alluminio · superficie verniciata a polveri o anodizzata · lente retrocessa con ottica tripla o quadro · anti-abbagliamento garantito da una griglia nera lucida · sensore di movimento e rilevatore quantità di luce e wireless funzione di rete

Lampadaire extra-fin à LED en aluminium · surface lacquée en poudre ou anodisée · optique à émission triple ou quad · grille basse-luminance · détecteur de mouvement, capteur de lumière et fonction réseau sans fil.

LENS TRIPLE F

SYS 111W	UGR<16	LM
646-1126605WWXXY		11480

In der Mitte von drei Arbeitsplätzen platzieren
Place in center of three workstations

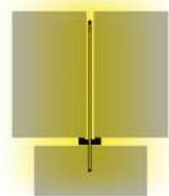
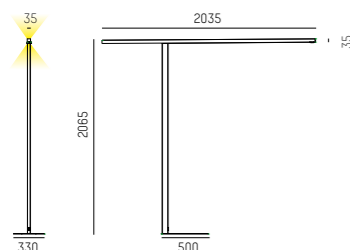

Light beam

60°

40°

IP20

LENS QUAD F

SYS 222W	UGR<16	LM
646-1076205WWXXY		22960

In der Mitte von vier Arbeitsplätzen platzieren
Place in center of four workstations

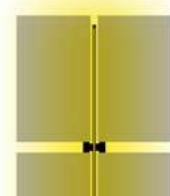
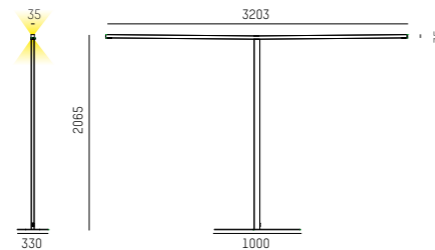

PUSH BUTTON MOTION SWARM

646-000040000050 ON / OFF & Dimm

646-000040000060 ON / OFF & Dimm

Optionaler radio push-button

Optional radio push-button

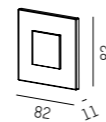

COMPLETE CODE			
G = PUSH BUTTON	WW = LIGHT COLOUR	XX = COLOUR	Y = DIMMABLE
push button = 0	LED 3000K = 29	white = 05	switchable = 0
foil button = 1	LED 4000K = 24	black = 06	motion swarm = m (without foil or push button)
motion swarm = 0		aluminium anodized = 08	push-button dimm. = t
			motion daylight = k

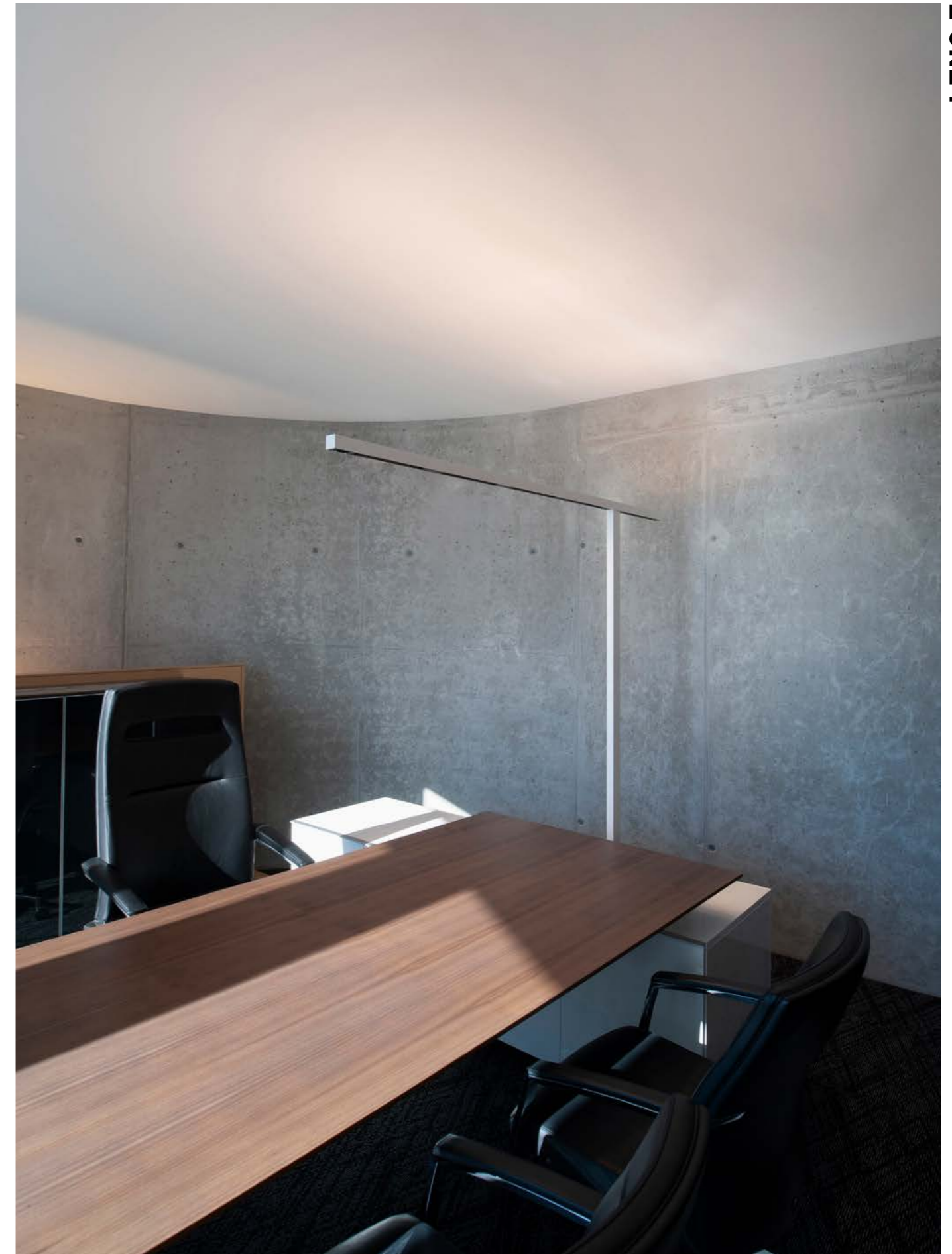

Technical data and energy efficiency



LENS TRIPLE F



LENS QUAD F

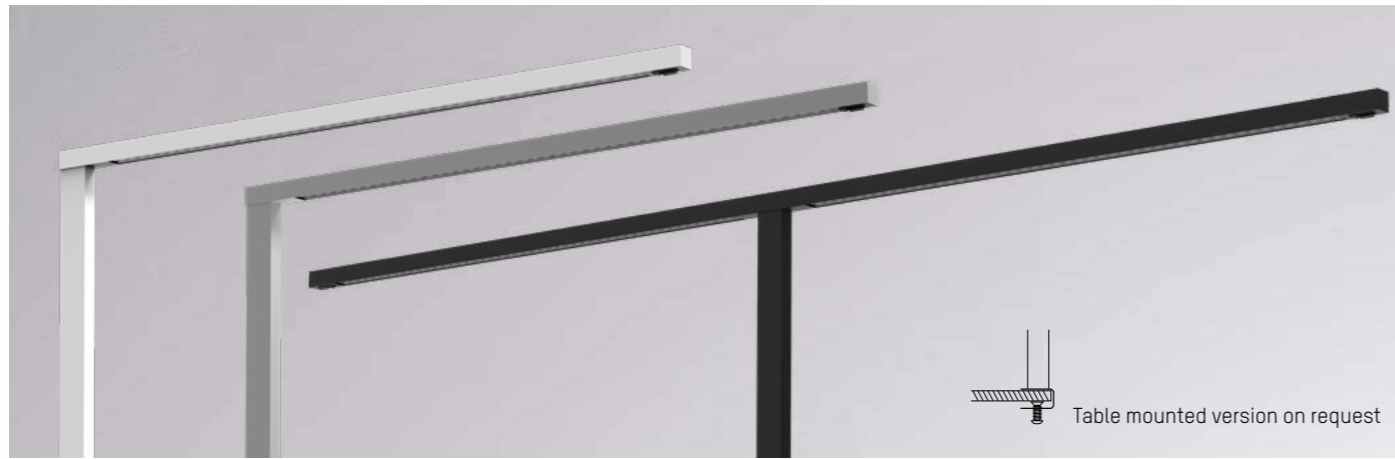

LENS SHORT F

220-240V AC 50/60Hz CRI>80 Design: INHOUSE

Superschlank LED Stehleuchte aus Aluminium · Oberfläche pulverbeschichtet oder eloxiert · Linsen mit Einzel-, Doppel- oder Quadarbeitsplatz Optik · perfekte Entblendung durch schwarzen Hochglanzraster · mit Tageslichtsensor, Bewegungsmelder und Schwarmfunktion
 Super-slim LED floor lamp in aluminium · surface powder-coated or anodized · recessed lens with single, double or quad workstation optic · perfect anti-glare due to black high-gloss grid · daylight control, motion detector and wireless swarm network-function
 Piantana a LED a ingombro ridotto in alluminio · superficie verniciata a polveri o anodizzata · lente retrocessa con ottica singola, doppia o quadro · anti-abbagliamento garantito da una griglia nera lucida · sensore di movimento e rilevatore quantità di luce e wireless funzione di rete
 Lampadaire extra-fin à LED en aluminium · surface lacquée en poudre ou anodisée · optique à émission simple, double ou quad · grille basse-luminance · détecteur de mouvement, capteur de lumière et fonction réseau sans fil.

LENS SHORT SINGLE F

SYS 48W	UGR<16	LM
646-1106103WWXXY		5600

In der Mitte eines Arbeitsplatzes platzieren
Place in center of one workstation

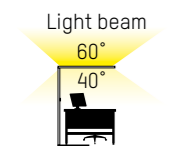
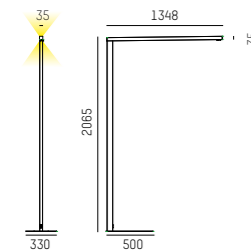

IP20 CE

LENS SHORT DOUBLE F

SYS 101W	UGR<16	LM
646-1106205WWXXY		10700

In der Mitte von zwei Arbeitsplätzen platzieren
Place in center of two workstations

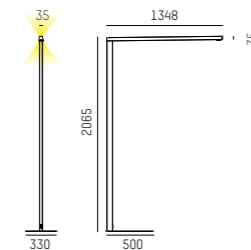

PUSH BUTTON MOTION SWARM

646-000040000050	W	ON / OFF & Dimm
646-000040000060	S	ON / OFF & Dimm

Optionaler radio push-button
Optional radio push-button

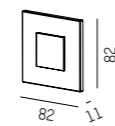

LENS SHORT QUAD F

SYS 202W	UGR<16	LM
646-1156205WWXXY		21400

In der Mitte von vier Arbeitsplätzen platzieren
Place in center of four workstations

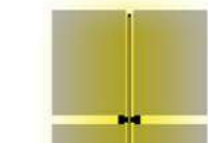
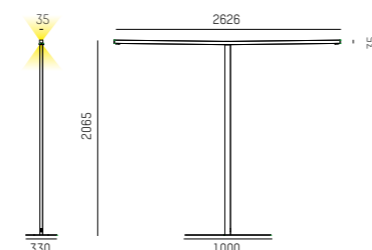

COMPLETE CODE			
G = PUSH BUTTON	WW = LIGHT COLOUR	XX = COLOUR	Y = DIMMABLE
push button = 0	LED 3000K = 29	white = 05	switchable = 0
foil button = 1	LED 4000K = 24	black = 06	motion swarm = m (without foil or push button)
motion swarm = 0		aluminium anodized = 08	push-button dimm. = t
			motion daylight = k



ID Werkstatt
Vorchdorf, Austria

LENS SHORT F



HP Ingenieure
Geretzried, Germany
© Jan Greune, hp-ingenieure.com

Technical data and energy efficiency

LENS SHORT SINGLE F

LENS SHORT DOUBLE F

LENS SHORT QUAD F

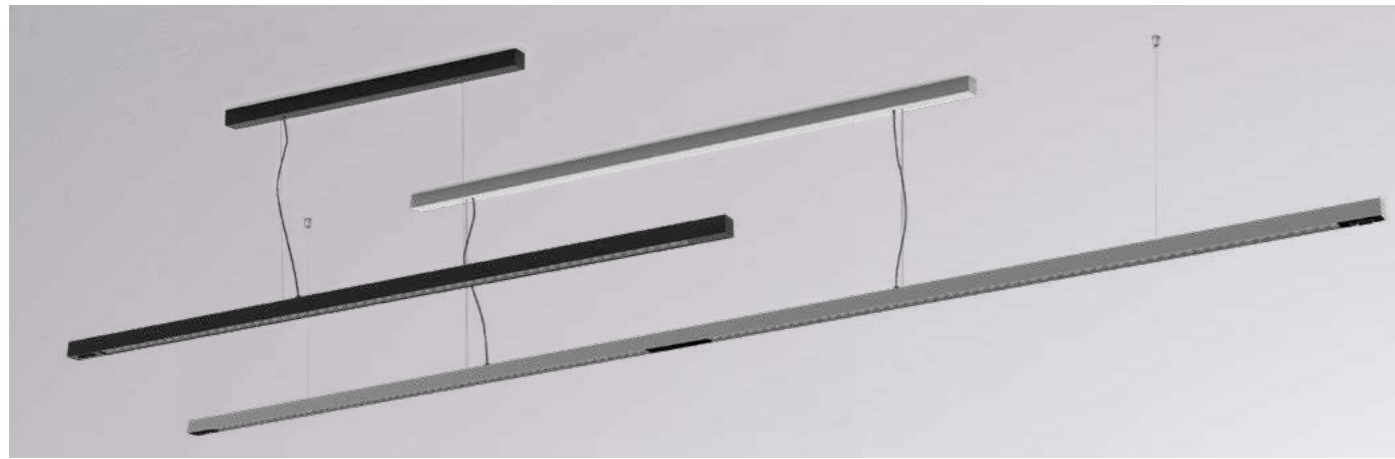

LENS PDI

220-240V AC 50/60Hz CRI>80 Design: INHOUSE

Superschlank LED Hängeleuchte aus Aluminium · Oberfläche pulverbeschichtet oder eloxiert · Linsen mit Einzel-, Doppel oder Quadarbeitsplatz Optik · perfekte Entblendung durch schwarzen Hochglanzraster · mit Tageslichtsensor, Bewegungsmelder und Schwarmfunktion

Super-slim LED suspension in aluminium · surface powder-coated or anodized · recessed lens with single, double or quad workstation optic · perfect anti-glare due to black high-gloss grid · daylight control, motion detector and wireless swarm network-function

Sospensione a LED a ingombro ridotto in alluminio · superficie verniciata a polveri o anodizzata · lente retrocessa con ottica singola, doppia o quadro · anti-abbagliamento garantito da una griglia nera lucida · sensore di movimento e rilevatore quantità di luce e wireless funzione di rete

Suspension extra-fin à LED en aluminium · surface lacquée en poudre ou anodisée · optique à émission simple, double ou quad · grille basse-luminance · détecteur de mouvement, capteur de lumière et fonction réseau sans fil.

LENS SINGLE PDI

SYS 53W	UGR<16	LM
646-1030103WWXXY		6100

In der Mitte eines Arbeitsplatzes platzieren
Place in center of one workstation

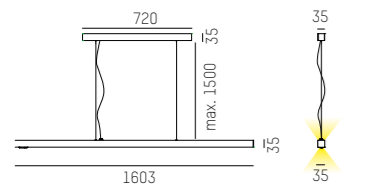

LENS DOUBLE PDI

SYS 111W	UGR<16	LM
646-1030205WWXXY		11480

In der Mitte von zwei Arbeitsplätzen platzieren
Place in center of two workstations

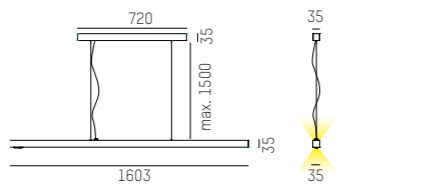

LENS QUAD PDI

SYS 222W	UGR<16	LM
646-1050205WWXXY		22960

In der Mitte von vier Arbeitsplätzen platzieren
Place in center of four workstations

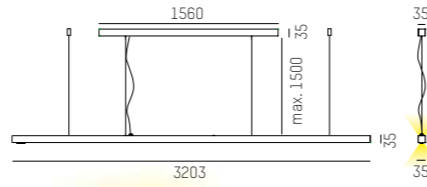

PUSH BUTTON MOTION SWARM

646-000040000050 **W** ON / OFF & Dimm

646-000040000060 **S** ON / OFF & Dimm

Optionaler radio push-button

Optional radio push-button

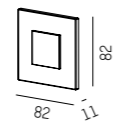

IP20

COMPLETE CODE

WW = LIGHT COLOUR	XX = COLOUR	Y = DIMMABLE
W3 LED 3000K = 29	W white = 05	S switchable = 0
W4 LED 4000K = 24	S black = 06	MS motion swarm = m
	AE aluminium anodized = 08	D DALI dimm. = d
		K motion daylight = k

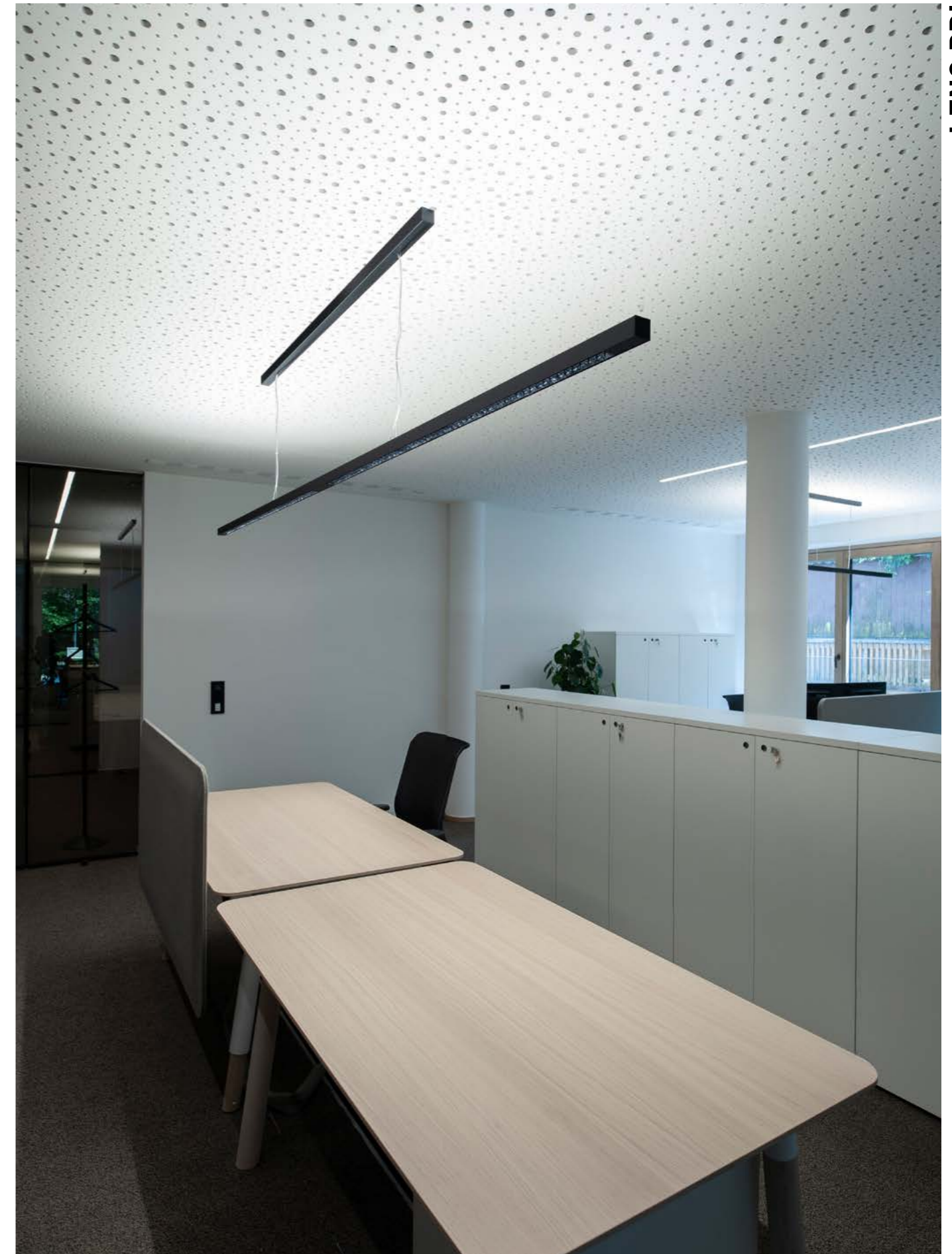

Raiffeisenbank Attersee-Süd
Nußdorf, Austria
Design + Architektur AREA.at
Photo: Joachim Rauch

Technical data and energy efficiency



LENS SINGLE PDI



LENS DOUBLE PDI



LENS QUAD PDI

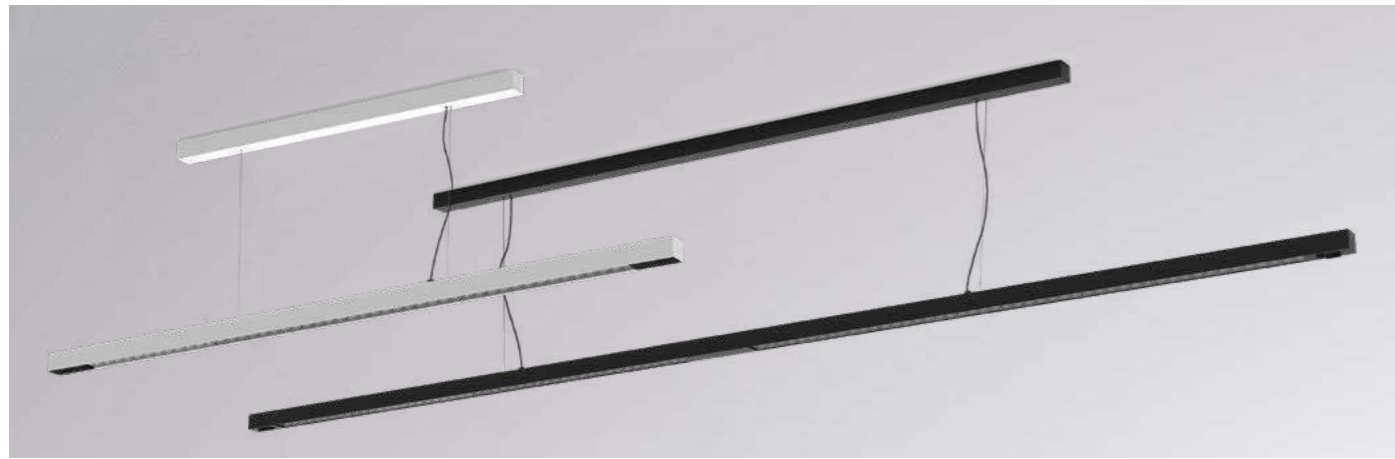

LENS SHORT PDI

220-240V AC 50/60Hz CRI>80 Design: INHOUSE

Superschlank LED Hängeleuchte aus Aluminium · Oberfläche pulverbeschichtet oder eloxiert · Linsen mit Einzel-, Doppel oder Quadarbeitsplatz Optik · perfekte Entblendung durch schwarzen Hochglanzraster · mit Tageslichtsensor, Bewegungsmelder und Schwarmfunktion

Super-slim LED suspension in aluminium · surface powder-coated or anodized · recessed lens with single, double or quad workstation optic · perfect anti-glare due to black high-gloss grid · daylight control, motion detector and wireless swarm network-function

Sospensione a LED a ingombro ridotto in alluminio · superficie verniciata a polveri o anodizzata · lente retrocessa con ottica singola, doppia o quadro · anti-abbagliamento garantito da una griglia nera lucida · sensore di movimento e rilevatore quantità di luce e wireless funzione di rete

Suspension extra-fin à LED en aluminium · surface lacquée en poudre ou anodisée · optique à émission simple, double ou quad · grille basse-luminance · détecteur de mouvement, capteur de lumière et fonction réseau sans fil.

LENS SHORT SINGLE PDI

SYS 48W	UGR<16	LM
646-1080103WWXXY		5600

In der Mitte eines Arbeitsplatzes plazieren
Place in center of one workstation

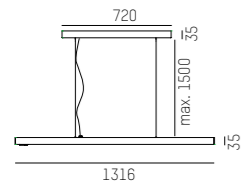

LENS SHORT DOUBLE PDI

SYS 101W	UGR<16	LM
646-1080205WWXXY		10700

In der Mitte von zwei Arbeitsplätzen plazieren
Place in center of two workstations

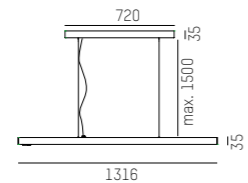

LENS SHORT QUAD PDI

SYS 162W	UGR<16	LM
646-1130205WWXXY		18460

In der Mitte von vier Arbeitsplätzen plazieren
Place in center of four workstations

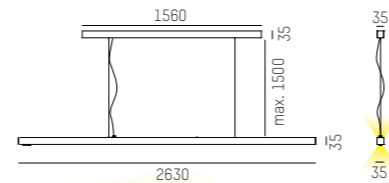

PUSH BUTTON MOTION SWARM

646-000040000050 **W** ON / OFF & Dimm

646-000040000060 **S** ON / OFF & Dimm

Optionaler radio push-button

Optional radio push-button

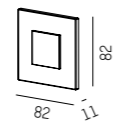

IP20 CE

COMPLETE CODE

WW = LIGHT COLOUR	XX = COLOUR	Y = DIMMABLE
W3 LED 3000K = 29	W white = 05	S switchable = 0
W4 LED 4000K = 24	S black = 06	MS motion swarm = m
	AE aluminium anodized = 08	D DALI dimm. = d
		K motion daylight = k

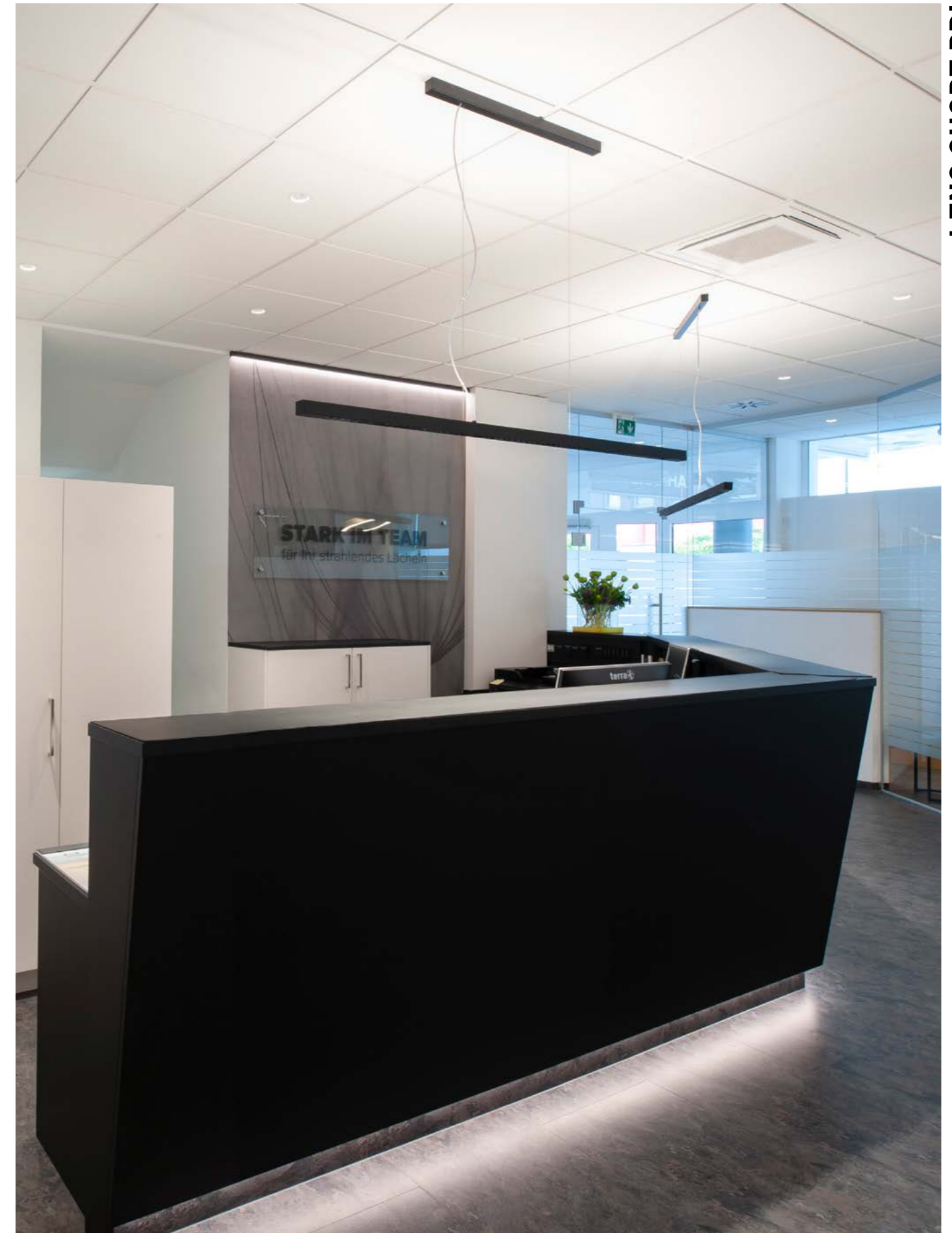

Dentist Dr. Loidl
Wels, Austria
Photo: Joachim Rauch



LENS SHORT SINGLE PDI

LENS SHORT DOUBLE PDI

LENS SHORT QUAD PDI

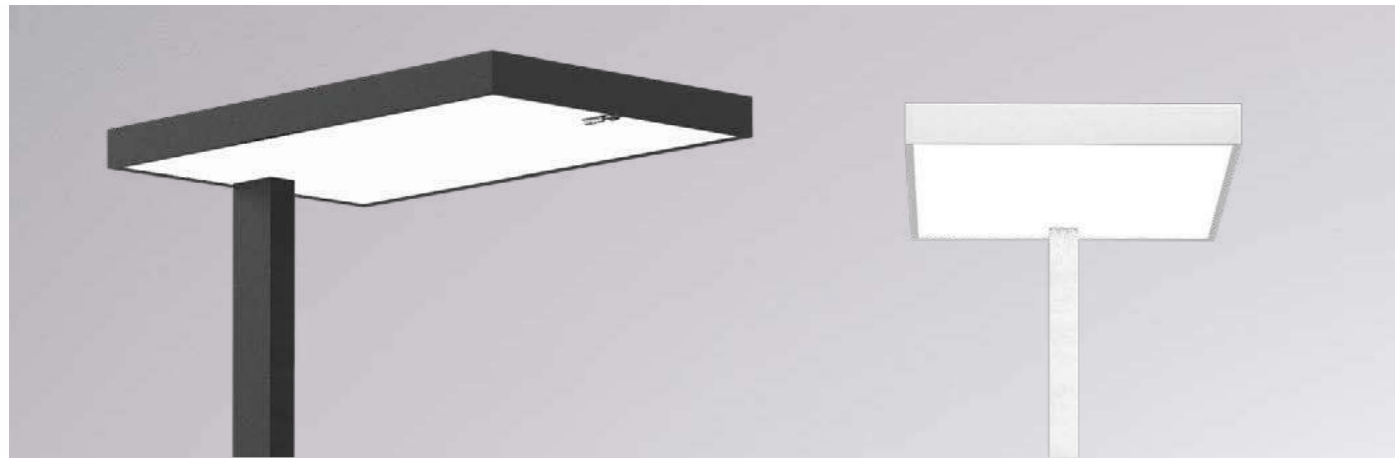

SYSTEM 01.1 F

220-240V AC 50/60Hz CRI>80 Design: INHOUSE

LED Stehleuchte direkt- / indirekt strahlend · hochtransparente Mikroprismen direkt, klare Abdeckung indirekt · versionsspezifisch: Taster dimmbar, Bewegungsmelder und Tageslichtsensor oder als Bewegungsmelder mit Tageslichtsensor und wireless Schwarm Netzwerkfunktion

LED floor lamp with direct and indirect beam · highly transparent microprismatic diffuser direct and clear cover indirect · versions with dimmable switch, motion detector and daylight control or motion detector and daylight control and wireless swarm network-function

Piantana a LED con luce diretta ed indiretta · diretta con diffusore microprismatico ad alta trasparenza, indiretta con copertura trasparente · dimmerabile con pulsante, Rivelatore di movimento e controllo luce del giorno oppure, rivelatore di movimento e controllo luce del giorno e wireless funzione di rete

Lampadaire LED avec émission directe et indirecte · diffuseur microprismatique haute qualité, indirect diffuseur transparent · dimmable avec interrupteur, détecteur de mouvement et contrôle lumière de jour ou détecteur de mouvement et contrôle lumière de jour et wireless fonction du réseau

SYS 93W	UGR<19	LM
697-0606130WWXXY		13640 - 14290

PUSH BUTTON MOTION SWARM

646-000040000050 **W** ON / OFF & Dimm

646-000040000060 **S** ON / OFF & Dimm

Optionaler radio push-button
Optional radio push-button

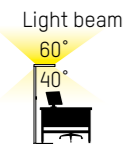
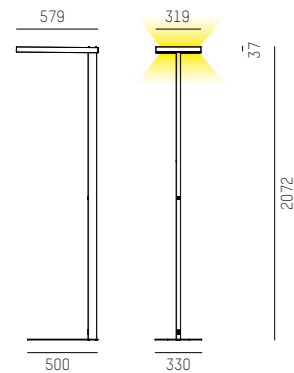
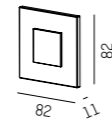

IP20

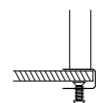
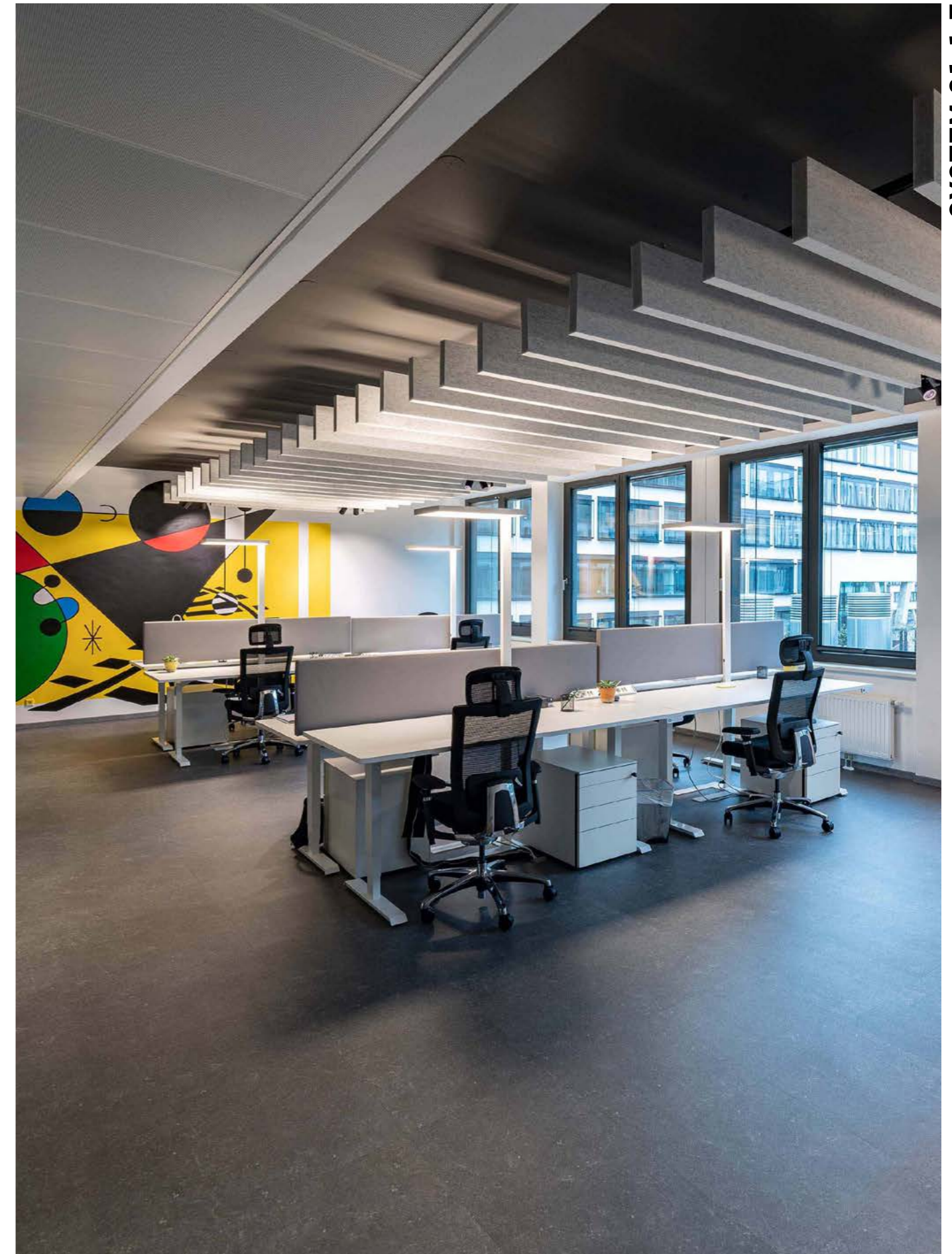

Table mounted version on request



COMPLETE CODE			
G = PUSH BUTTON	WW = LIGHT COLOUR	XX = COLOUR	Y = DIMMABLE
push button = 0	LED 3000K = 19	grey = 04	switchable = 0
foil button = 1	LED 4000K = 14	white = 05	motion swarm = m (without foil or push button)
motion swarm = 0		black = 06	push-button dimm. = t
			motion daylight = k



Technical data and energy efficiency





SYSTEM 01.1 PDI

220-240V AC 50/60Hz CRI>80 Design: INHOUSE

Schlanke Hängeleuchte aus Aluminiumprofil · Oberfläche pulverbeschichtet oder eloxiert · Direktabdeckung mit hochtransparenten Mikroprismen · erhältlich in 2 Längen · Abstrahlung mit Direkt- und Indirektanteil

Slim aluminium pendant · surface powder-coated or anodized · down light with highly clear microprismatic diffuser · in two lengths available · up and downlight emission

Sottile sospensione in alluminio · superficie verniciata a polveri o anodizzata · emissione diretta con microprismatico ad alta trasparenza · disponibile in due lunghezze · emissione diretta ed indiretta

Mince suspension en aluminium · surface laquée en poudre ou anodisée · diffuseur à haute transparence en microprismes · disponible en deux longueurs · émission directe et indirecte

SYS 50W	UGR<19	LM
697-0100030	WWXXY	7540 - 7900

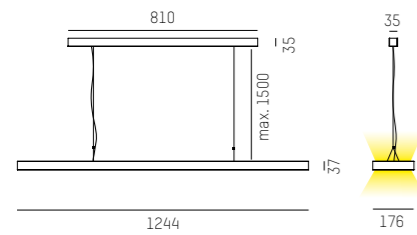

SYS 63W	UGR<19	LM
697-0200030	WWXXY	9430 - 9870

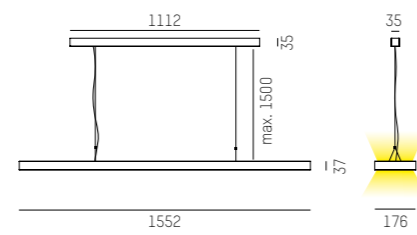

PUSH BUTTON MOTION SWARM

646-00004000050 ON / OFF & Dimm

646-00004000060 ON / OFF & Dimm

Optionaler radio push-button
Optional radio push-button

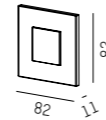

MECHANISCHER VERBINDER

MECHANICAL CONNECTION

697-00198

zur Verbindung von 2 Leuchten
for connection of 2 pendants



Light beam

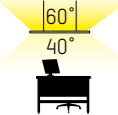

IP20

COMPLETE CODE		
WW = LIGHT COLOUR	XX = COLOUR	Y = DIMMABLE
<input type="checkbox"/> W3 LED 3000K = 19	<input type="checkbox"/> W white = 05	<input type="checkbox"/> S switchable = 0
<input type="checkbox"/> W4 LED 4000K = 14	<input type="checkbox"/> S black = 06	<input type="checkbox"/> D DALI dimm. = d
	<input type="checkbox"/> AE aluminium anodized = 08	<input type="checkbox"/> MS motion swarm = m
		<input type="checkbox"/> K motion daylight = k



Technical data and energy efficiency





SYSTEM 02.1 F

220-240V AC 50/60Hz CRI>80 Design: INHOUSE

LED Stehleuchte direkt- / indirekt strahlend · hochtransparente Mikroprismen direkt, klare Abdeckung indirekt · versionsspezifisch: Taster dimmbar, Bewegungsmelder und Tageslichtsensor oder als Bewegungsmelder mit Tageslichtsensor und wireless Schwarm Netzwerkfunktion

LED floor lamp with direct and indirect beam · highly transparent microprismatic diffuser direct and clear cover indirect · versions with dimmable switch, motion detector and daylight control or motion detector and daylight control and wireless swarm network-function

Piantana a LED con luce diretta ed indiretta · diretta con diffusore microprismatico ad alta trasparenza, indiretta con copertura trasparente · dimmerabile con pulsante, Rivelatore di movimento e controllo luce del giorno oppure, rivelatore di movimento e controllo luce del giorno e wireless funzione di rete

Lampadaire LED avec émission directe et indirecte · diffuseur microprismatique haute qualité, indirect diffuseur transparent · dimmable avec interrupteur, détecteur de mouvement et contrôle lumière de jour ou détecteur de mouvement et contrôle lumière de jour et wireless fonction du réseau

SYS 93W	UGR<19	LM
725-0406130WWXXY		13640 - 14290

PUSH BUTTON MOTION SWARM

646-000040000050  ON / OFF & Dimm

646-000040000060  ON / OFF & Dimm

Optionaler radio push-button
Optional radio push-button

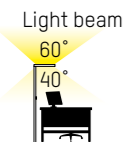
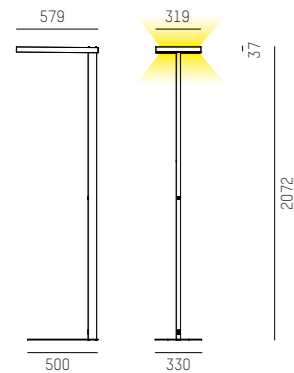
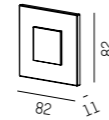















IP20 

Table mounted version on request 

COMPLETE CODE			
G = PUSH BUTTON	WW = LIGHT COLOUR	XX = COLOUR	Y = DIMMABLE
 push button = 0	 LED 3000K = 19	 white = 05	 switchable = 0
 foil button = 1	 LED 4000K = 14	 black = 06	 motion swarm = m (without foil or push button)
 motion swarm = 0		 aluminium anodized = 08	 push-button dimm. = t
			 motion daylight = k

206



SYSTEM 02.1 F

Technical data and energy efficiency



Molto Luce
Wels, Austria
Photo: Joachim Rauch

207

SYSTEM 02.1 F

BACK TO CONTENT

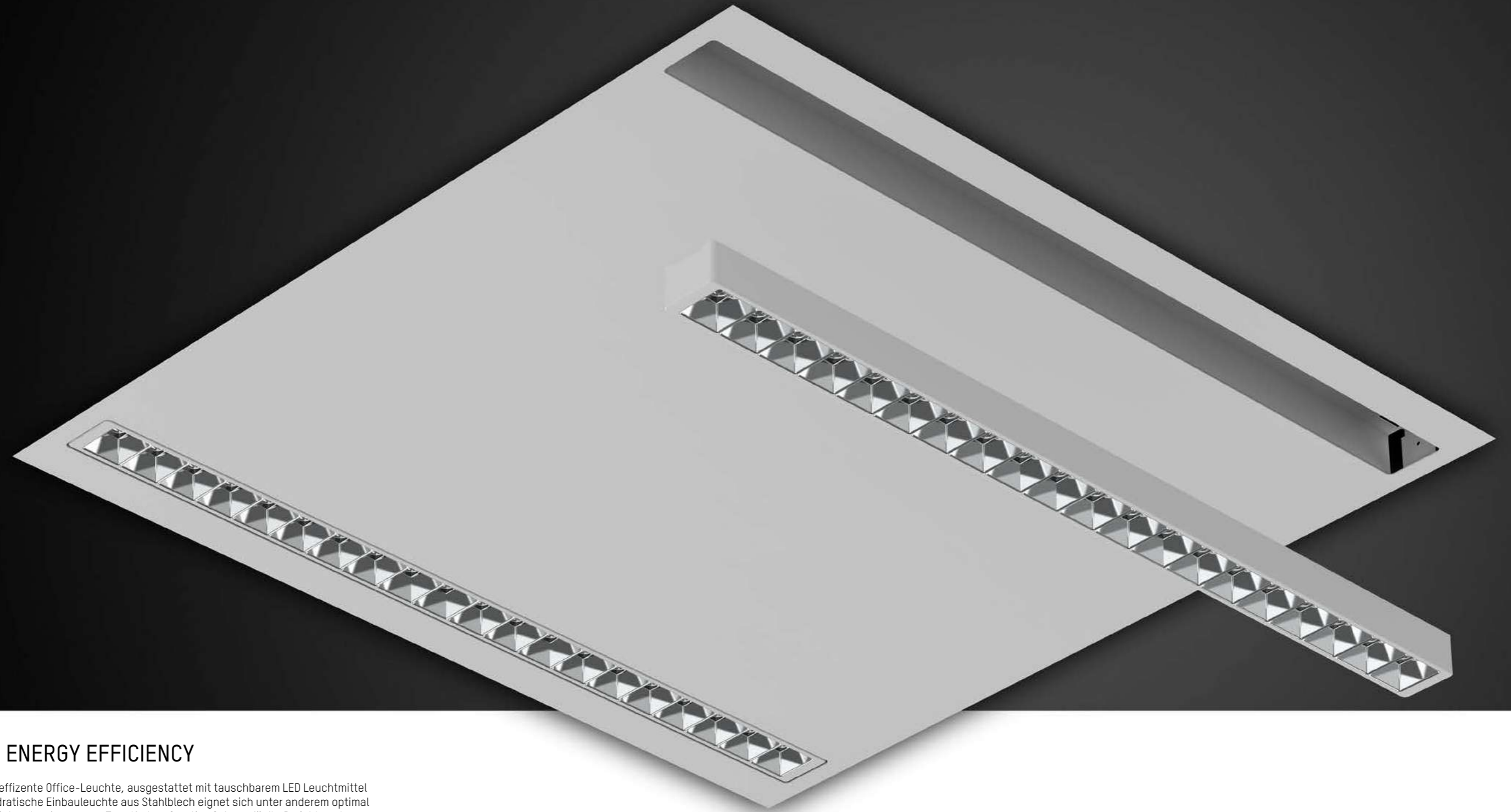

X-CHANGE TO ENERGY EFFICIENCY

INTERO ist unsere energieeffiziente Office-Leuchte, ausgestattet mit tauschbarem LED Leuchtmittel und Konverter. Diese quadratische Einbauleuchte aus Stahlblech eignet sich unter anderem optimal für Rasterdecken. INTERO ist zudem in unseren Trendfarben Creative Colours für Ihr Projekt nach Wunsch individualisierbar.

INTERO is our energy-efficient office luminaire equipped with an interchangeable LED bulb and converter. This square recessed luminaire made of steel plate is particularly suitable for louvred ceilings. INTERO can also be customised to your wishes with our trendy Creative Colours.

Design: INHOUSE

INTERO

Single versions

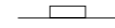

single recessed

Sizes



597 x 597mm

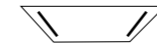

620 x 620mm

Core Colours



white

Creative Colours



copper



berlin blue



gold



berry blue



merlot



terra



black



highland green



creme



sepia



anthrazit



forest



bronze



grey

LED Colour



3000K



4000K

Special



LED insert & converter insert changable

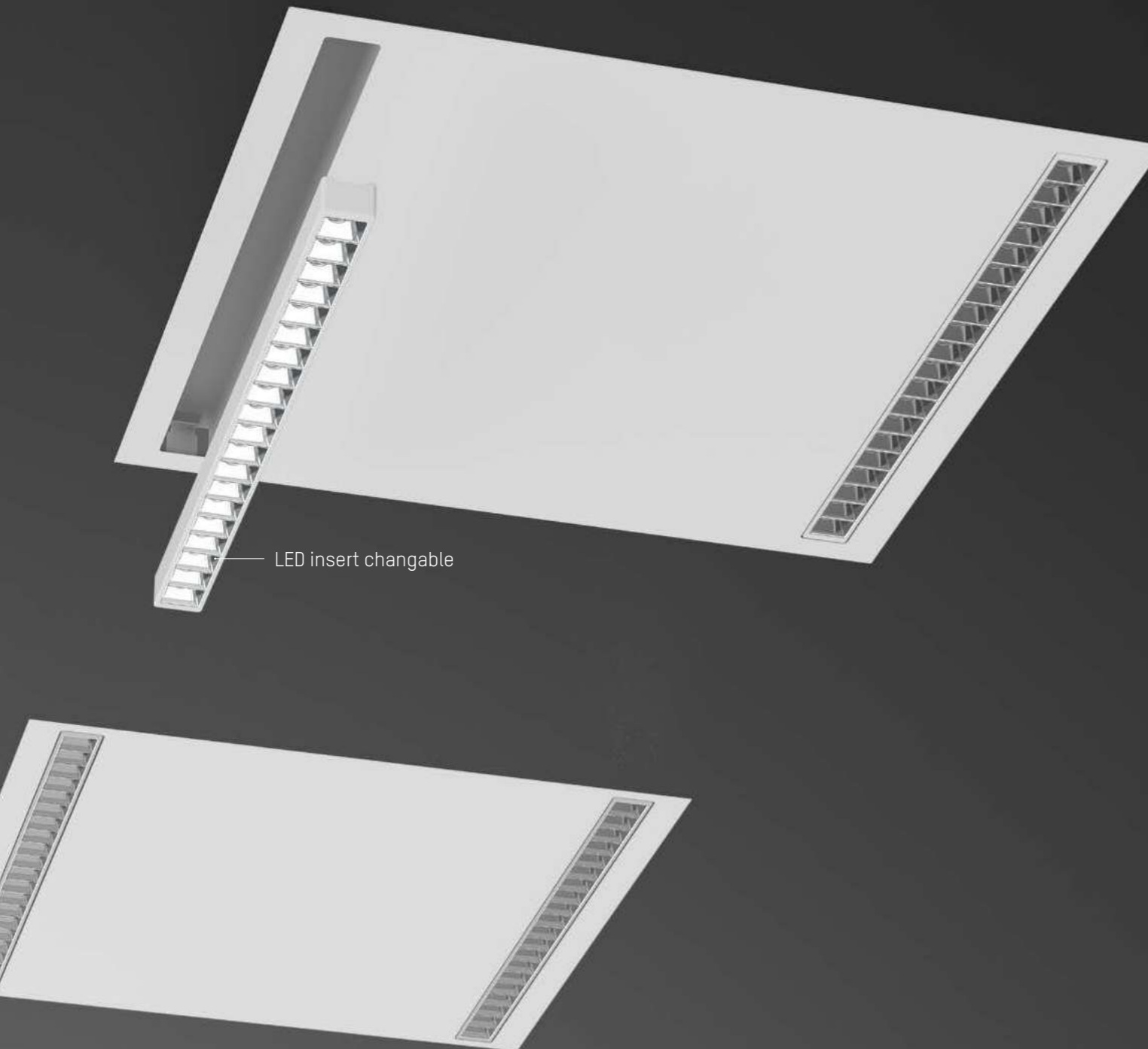

Design: INHOUSE

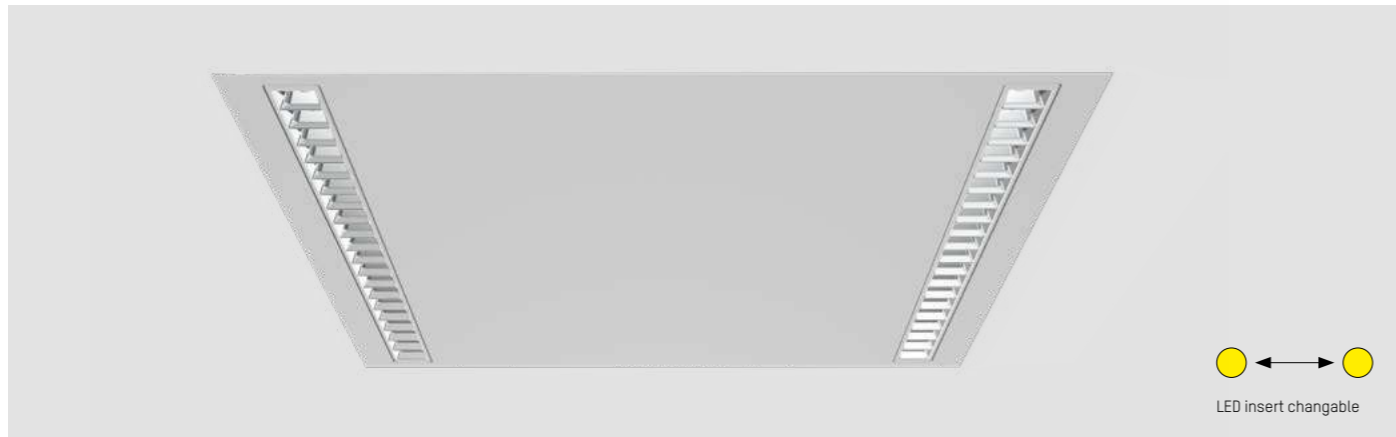

INTERO ECO 600 / 625 R

220-240V AC 50/60Hz UGR<19 Design: INHOUSE

LED Einbauleuchte aus Stahlblech · Oberfläche pulverbeschichtet · Lichteinsatz wechselbar · inkl. Konverter · Steckfertig mit 5 pol. Adels Stecker
 LED recessed luminaire made of sheet steel - powder-coated surface - light insert can be changed - incl. converter - ready to plug in with 5-pin Adels plug
 Lampada LED ad incasso in lamiera d'acciaio · verniciata a polveri · Inserti luce intercambiabili · converter incluso · Plug&Play con spina 5 poli Adels
 Luminaire encastrée LED - Surface revêtue de poudre - Inserts lumineux interchangeables - Convertisseur inclus - Plug&Play avec fiche Adels à 5 broches

SYS 18 - 36W L: 597 x W 597mm **LM**
712-01170112WW05Y 2358 - 4780
 Strom einstellbar 18 - 36W (350 - 700mA)
 Power switchable 18 - 36W (350 - 700mA)
 Austrahlwinkel: 2 x 80° / Beam angle: 2 x 80°

SYS 18 - 36W L: 620 x W 620mm **LM**
712-01180112WW05Y 2358 - 4780
 Strom einstellbar 18 - 36W (350 - 700mA)
 Power switchable 18 - 36W (350 - 700mA)
 Austrahlwinkel: 2 x 80° / Beam angle: 2 x 80°

BEFESTIGUNGSKLAMMERN **SET**
MOUNTING CLAMBS **SET**
712-0595000000000 4 pcs.

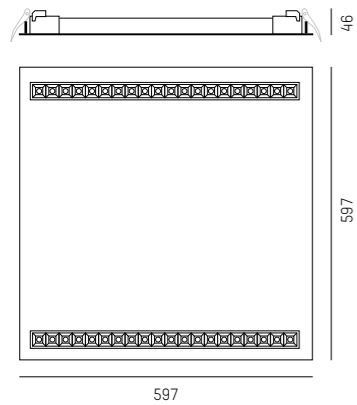

579 x 579mm
 76mm
 12,5 - 45mm

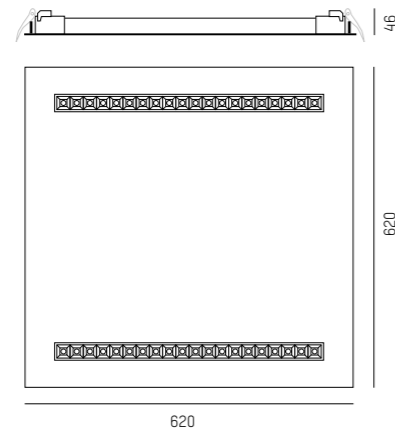

604 x 604mm
 76mm
 12,5 - 45mm

IP20



COMPLETE CODE	
WW = LIGHT COLOUR	Y = DIMMABLE
W2 LED 3000K = 19 CRI<80	switchable = 0
W3 LED 4000K = 14 CRI<80	DALI dimm. = d



Technical data and energy efficiency



INTERO ECO 600 R



INTERO ECO 625 R



SILENT MOOD OF LIGHT

Reduzierte akustische Belastungen, steigern Wohlbefinden, Konzentration sowie Leistungsfähigkeit und der Stresslevel sinkt nachweislich. Speziell in Vortrags- und Hörsälen, Theatern, Seminar-, Klassen-, und Büroräumen spielt die Akustik eine wesentliche Rolle. Optimiert werden kann das akustische Verhalten durch das Platzieren schallabsorbierender Elemente im Raum.

Akustik Baffeln mit Lichteinsätzen

Unsere Baffeln aus thermisch verfestigtem Vliesstoff verringern durch eine möglichst große und diffus reflektierende Fläche die Lärmbelastung und bestehen zudem aus 60% recycelten PET-Flaschen. Die Abhängehaken, welche absolut flächenbündig in der Baffle sitzen, werden direkt mit der 3-Phasen Stromschiene verbunden und sind ohne weiteren Montageaufwand variabel entlang der Stromschiene platzierbar. Beleuchtungselemente wie MOVA oder LOG 50 sind in der Stirnkante montiert und erzeugen neben einer hervorragenden Raumakustik die passende Lichtstimmung.

A reduced acoustic impact enhances the well-being, concentration and the performance and has proven to reduce stress. Especially in auditoriums, theatres, seminar and class rooms as well as in offices the acoustic plays a major role. The acoustic behaviour can be optimized by sound-absorbing elements in the room.

Acoustic baffles with light inserts

With their large and diffuse reflecting surface, our baffles made of thermally bonded non-woven fabric reduce the noise impact. On top of that, they are made of 60% of recycled PET bottles. The suspension hooks, fully flush in the baffle, are directly attached to the 3-phase track system and can be placed variably along the track system without the need to reassemble it. Illumination elements like MOVA or LOG50 are mounted on the front edge and create not only excellent room acoustics, but also the right lighting atmosphere.

Design: Ben Elmecker (e-design) & INHOUSE

ACOUSTICS

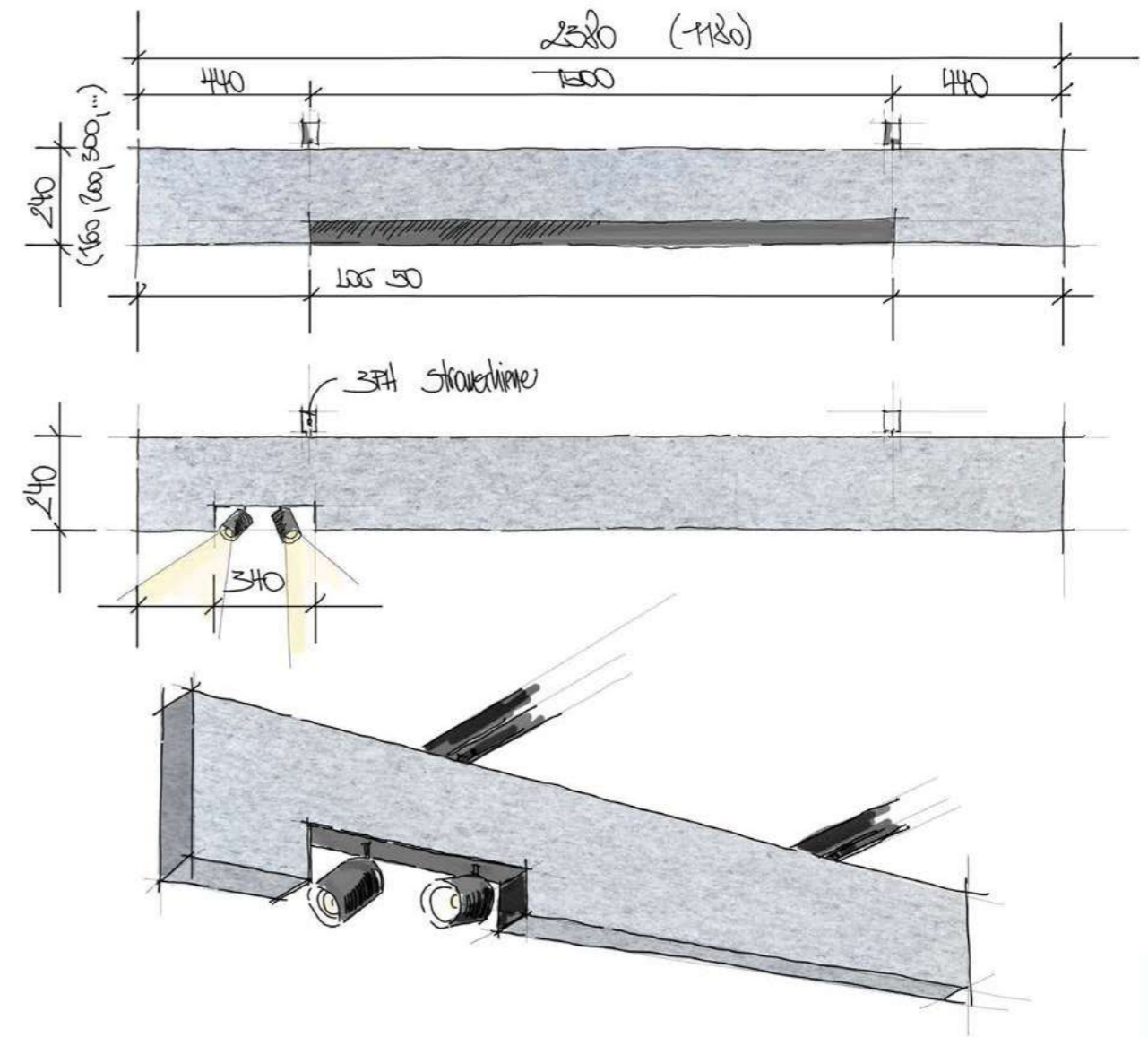

Design draft

ben elmecker



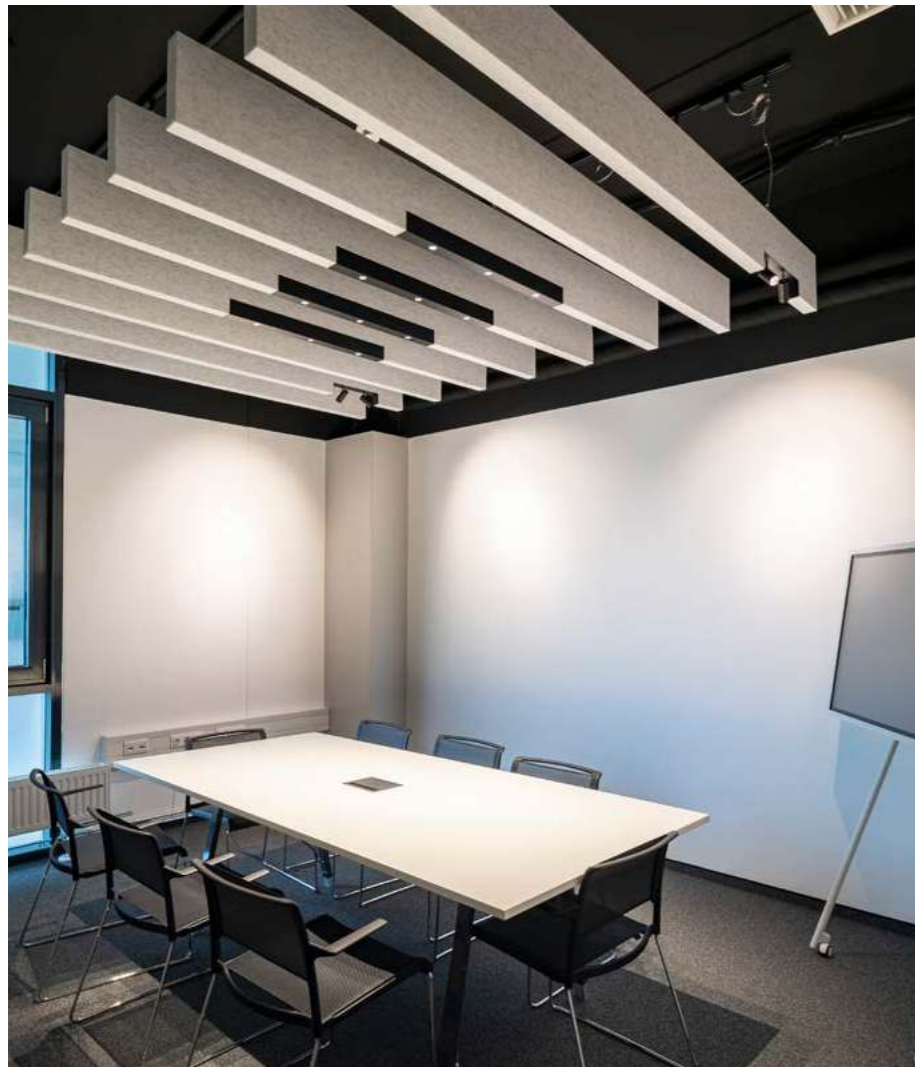
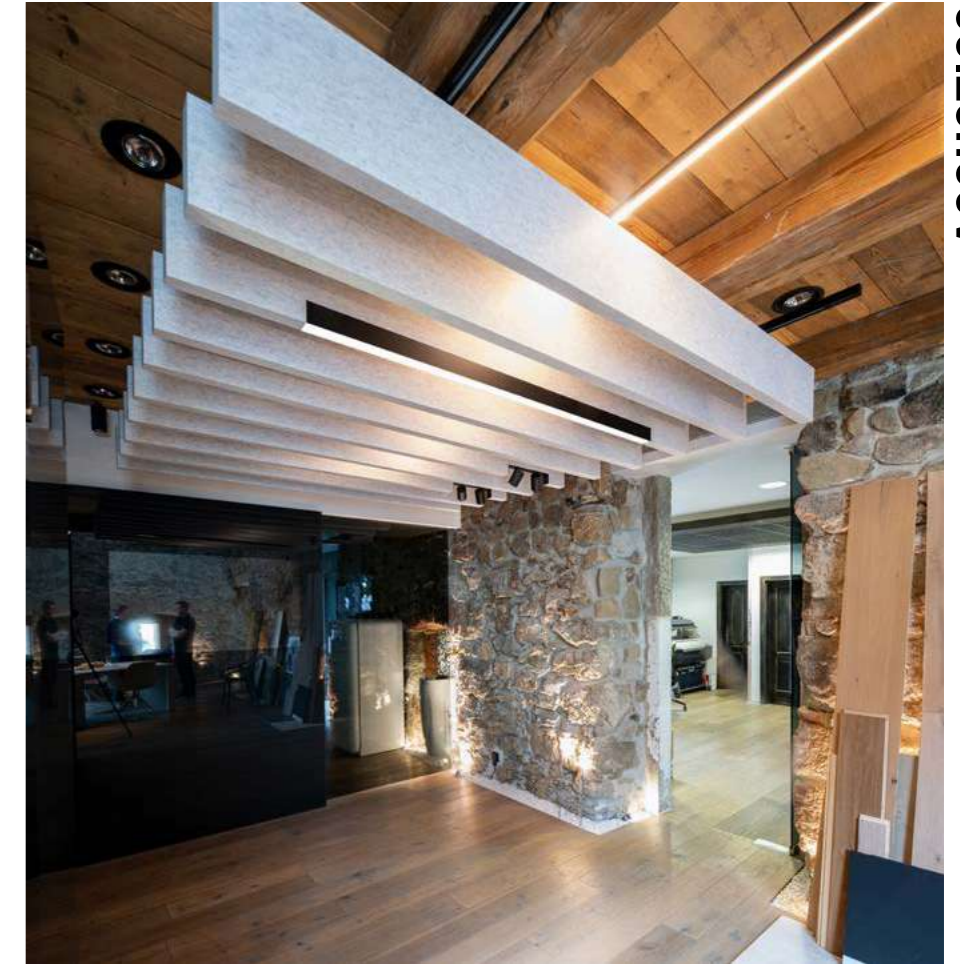
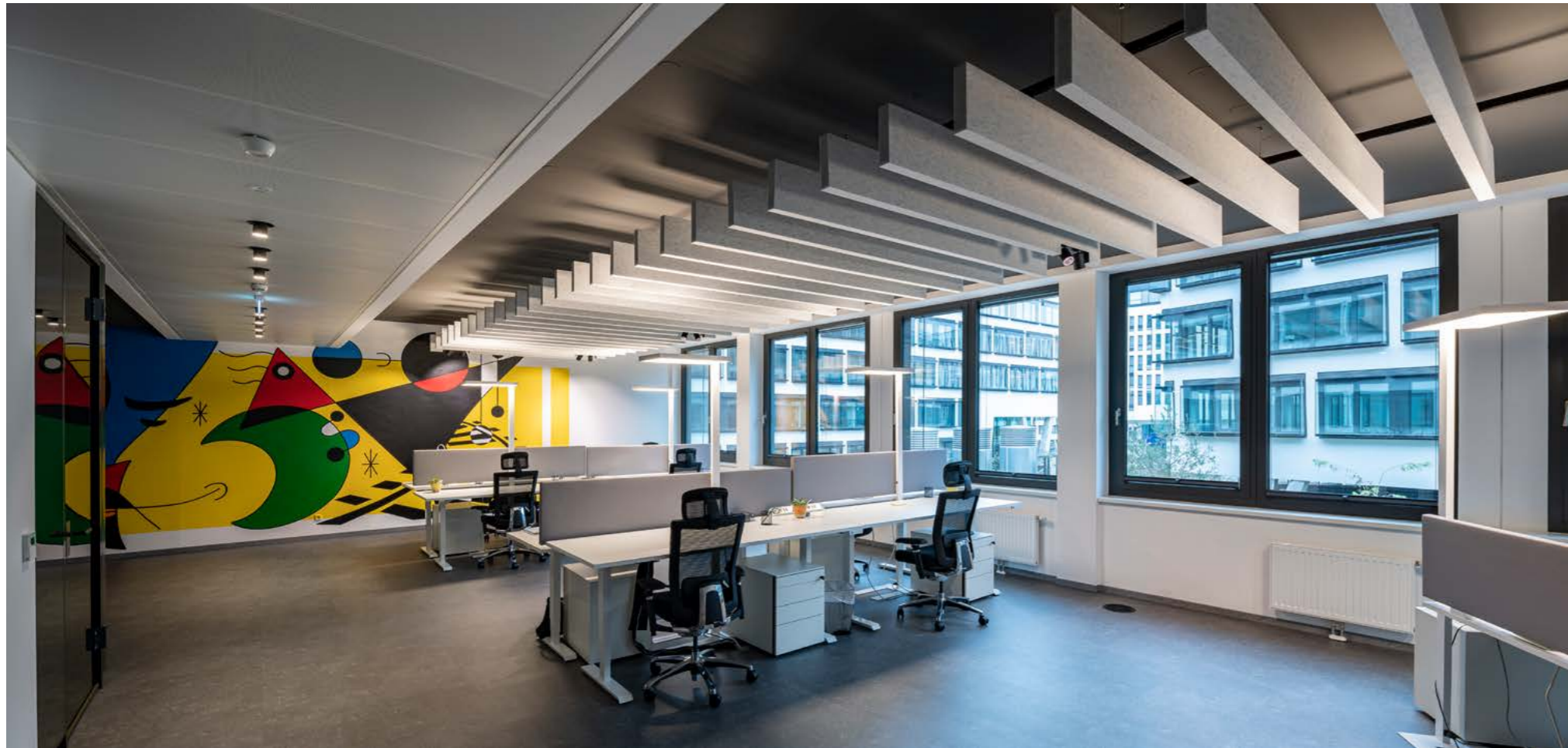

TMC
Vienna, Austria
Planing & Realisation: Ben Elmecker
Photo: Joachim Rauch



Office Ben Elmecker
Rainbach, Austria
Photo: Joachim Rauch

TMC
Vienna, Austria
Planing & Realisation: Ben Elmecker
Photo: Joachim Rauch

Wimberger Haus
Lasberg, Austria
Planing & Realisation: Ben Elmecker
Photo: Joachim Rauch



Molto Luce
Weißkirchen, Austria
Planing & Realisation: Ben Elmecker
Photo: Joachim Rauch



BOARD

Die aus akustisch wirksamem Material gefertigte Hängeleuchte BOARD verfügt über eine direkte/ indirekte Lichtverteilung im Verhältnis 30:60. Der direkte Lichtanteil ist breitstrahlend und die indirekte Beleuchtung ist 4x asymmetrisch für eine großflächige homogene Deckenaufhellung. Die direkten Reflektoren sind absolut flächenbündig in den Absorber integriert.

The suspension luminaire BOARD made of acoustic damping material has a direct/indirect light distribution at a 30:60 ratio. The direct light has a wide beam and the indirect light is 4x asymmetrical, which uniformly brightens up the ceiling over a large surface. The indirect reflectors are fully flush with the absorber.

Design: INHOUSE



DASH 2 TRACK

220-240V AC 50/60Hz UGR<19

Design: INHOUSE

Stromschiene Strahler aus Aluminium · Oberfläche pulverbeschichtet · Strahler 350° dreh-, 90° schwenkbar
 Track spotlight made of aluminium · powder-coated surface · spotlight 350° rotatable, 90° swivelling
 Faretto per binario in alluminio · superficie verniciata a polveri · testa girevole 350°, orientabile 90°
 Spot sur rail en aluminium · surface revêtue de poudre · tête orientable à 350°, pivotante à 90°.

SYS 10W / AC	LM
599-101010RWWXX0	500 - 590

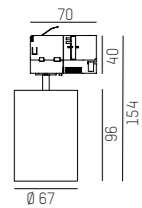

IP20 CE



COMPLETE CODE	WW = LIGHT COLOUR	XX = COLOUR
R = BEAM ANGLE		
☐ spot 17° = 2	W2 LED 2700K = 23 CRI>90	6 grey = 04
☐ medium 24° = 3	W3 LED 3000K = 29 CRI>90	W white = 05
☐ flood 40° = 4	W4 LED 4000K = 24 CRI>90	S black = 06



DASH 2 TRACK

Technical data and energy efficiency



DASH 2 TRACK



DASH 2 SD

220-240V AC 50/60Hz UGR<19

Design: INHOUSE

Aufbaustrahler aus Aluminium · Oberfläche pulverbeschichtet · für Deckenmontage · Strahler 350° dreh-, 90° schwenkbar
 Surface-mounted spotlight made of aluminium · powder-coated surface · for ceiling mounting · spotlight 350° rotatable, 90° swivelling
 Proiettore a plafone in alluminio · superficie verniciata a polveri · per montaggio a soffitto · testa girevole 350°, orientabile 90°
 Plafonnier en aluminium · surface revêtue de poudre · pour montage au plafond · tête orientable à 350°, pivotante à 90°.

SYS 10W / AC	LM
599-105010RWWXX0	500 - 590

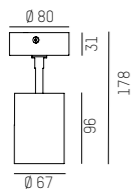

IP20



COMPLETE CODE	WW = LIGHT COLOUR	XX = COLOUR
R = BEAM ANGLE	W2 LED 2700K = 23 CRI>90	G grey = 04
spot 17° = 2	W3 LED 3000K = 29 CRI>90	W white = 05
medium 24° = 3	W4 LED 4000K = 24 CRI>90	S black = 06
flood 40° = 4		

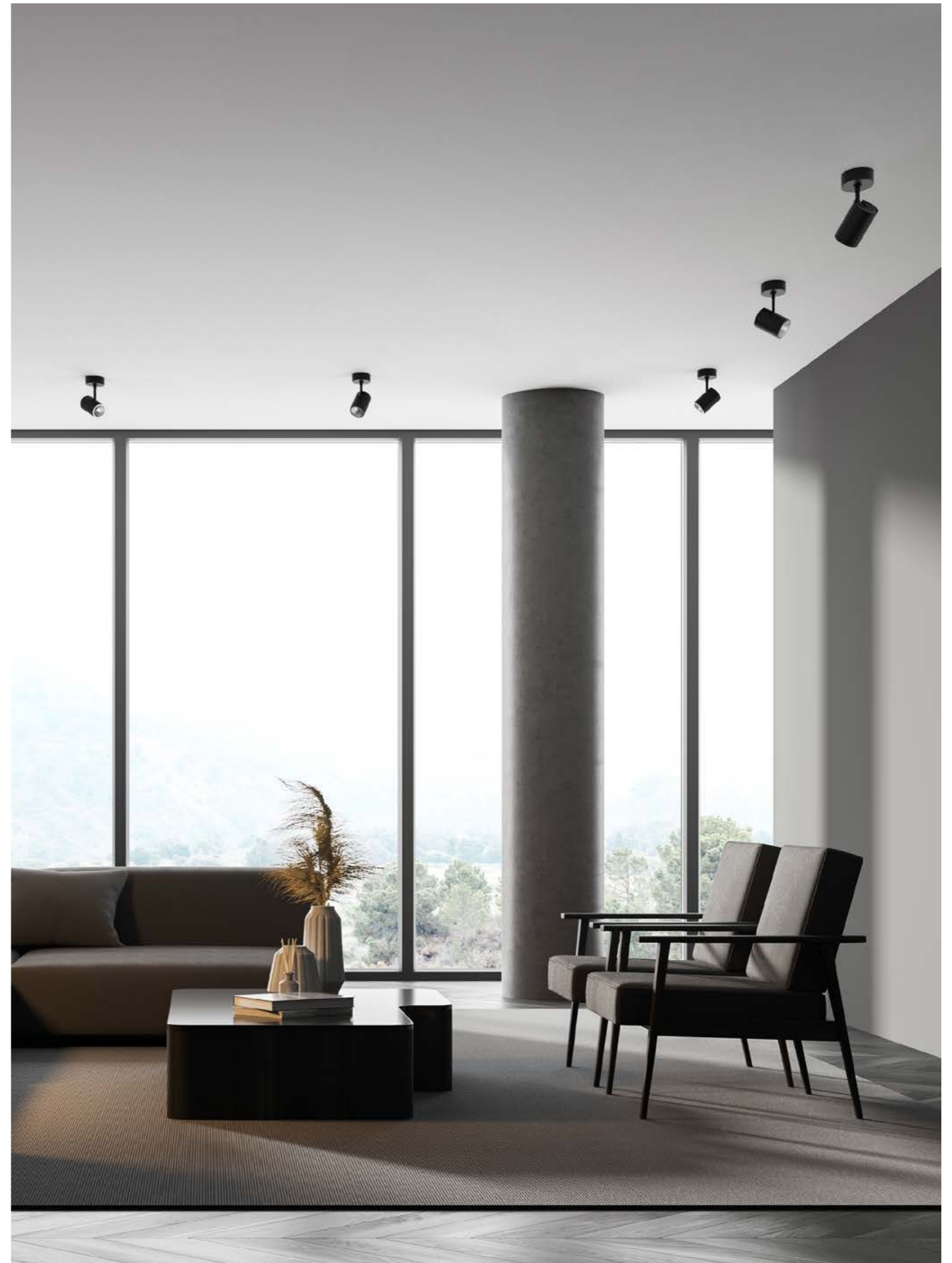

Technical data and energy efficiency



DASH 2 SD



INNOVATION WITH LFO LENS TECHNOLOGY

Die hochwertige und variantenreiche Leuchtenfamilie TRIGGA bringt das Licht auf besondere Art und Weise in den Raum. An der Austrittsöffnung wird das Licht durch die Bartenbach LFO Linsentechnik auf ein Minimum von 10 mm reduziert. Dies führt zu perfekter Entblendung und maßgeblicher Verbesserung des Sehkomforts. Durch ein speziell entwickeltes Gelenk kann das Licht perfekt gerichtet und mit zwei möglichen Ausstrahlwinkeln von 30° oder 55° gezielt auf die Beleuchtungsaufgabe abgestimmt werden.

The high-quality and versatile lighting family TRIGGA brings the light in a special way into the room. The light is reduced to a minimum of 10mm at the emission opening by the Bartenbach LFO Lens technology. This results in perfect glare and significant improvement in visual comfort. Thanks to a specially developed joint, the light can be directed perfectly and adjusted to the illumination task with two possible beam angles of 30° or 55°.

Design: Serge & Robert Cornelissen / INHOUSE

TRIGGA



Versions



Colour Colours

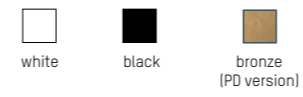

Creative Colours

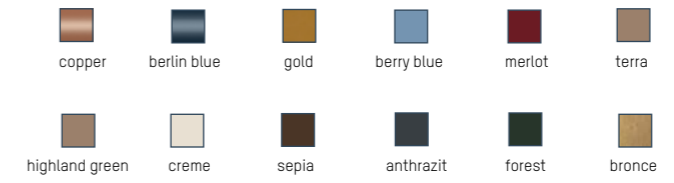

LED Colour

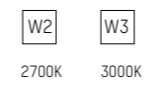

Special



Design: Serge & Robert Cornelissen / INHOUSE



TRIGGA R
UGR<16

Design: Serge & Robert Cornelissen / INHOUSE

LED Halbeinbauspot aus Aluminium · Oberfläche lackiert · zurückversetzte Linse mit verschiedenen Abstrahlwinkeln · Lichtaustrittsfläche von nur 10 mm
Semi recessed LED spotlight in aluminium · surface painted · recessed lenses with different beam-angles · light exit field with only 10 mm
Semi incasso LED in alluminio · superficie verniciata · lenti spostati indietro con varie emissioni · dispositivo d'illuminazione di soli 10 mm
Semi encastré LED en aluminium · surface laquée · lentilles décalées au fond avec d'émissions différentes · plus que 10 mm de surface d'émission de lumière

TRIGGA R

LED 6W - 500mA	LM
662-00602RRWWXXO	300 - 370

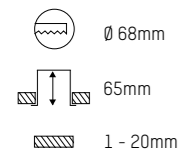
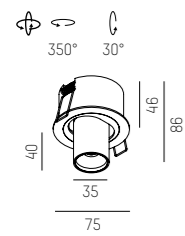

TRIGGA TRIMLESS R

LED 6W - 500mA	LM
662-00702RRWWXXO	300 - 370

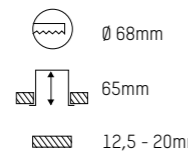
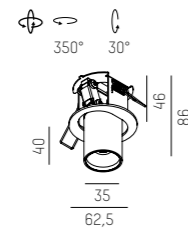

TRIGGA TRIMLESS R ACCESSORIES

MONTAGERING
MOUNTING RING
640-000010



WERKZEUG ZU MONTAGERING
TOOL FOR MOUNTING RING
640-000020



LFO Lens- Technology by Bartenbach

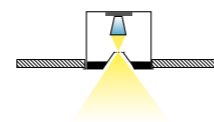

LED CONVERTER	mA	DIMM	FOR
24-122448	500	not dimmable	1 x TRIGGA R
24-151403	500	DALI dimmable	1 x TRIGGA R

IP20



COMPLETE CODE		
RR = REFLECTOR	WW = LIGHT COLOUR	XX = COLOUR
30° medium = 02	LED 2700K = 23 CRI>90	white = 55
55° flood = 05	LED 3000K = 29 CRI>90	black = 66

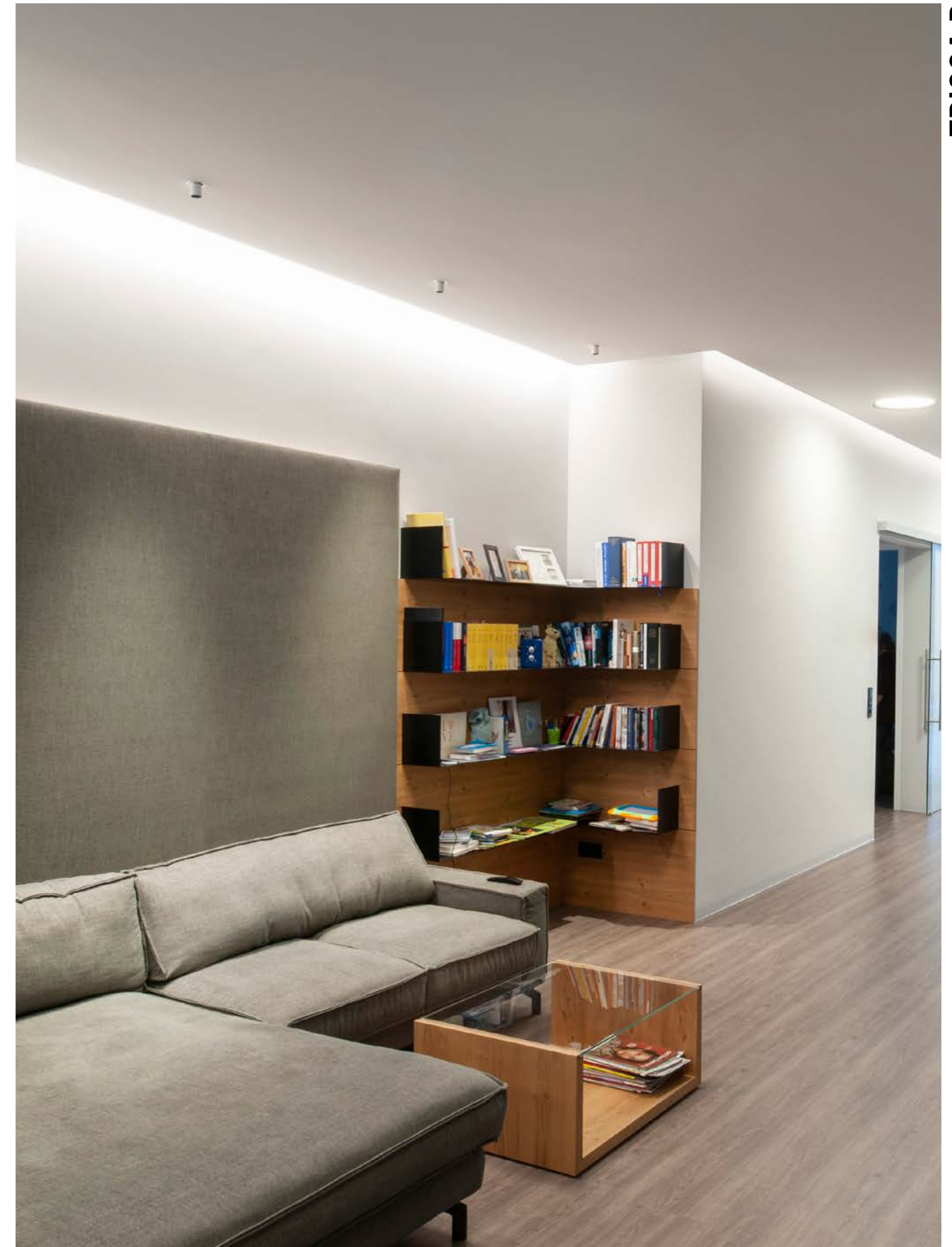

Private residence
Austria
Photo: Joachim Rauch

Technical data and energy efficiency



TRIGGA R



TRIGGA TRIMLESS R



TRIGGA SD

220-240V AC 50/60Hz UGR<16

Design: Serge & Robert Cornelissen / INHOUSE

LED Aufbaustrahler aus Aluminium · Oberfläche pulverbeschichtet · Zurückversetzte Linse mit verschiedenen Abstrahlwinkeln
 LED spotlight in aluminium · surface powder-coated · Recessed lenses with different beam-angles
 Faretto a LED in alluminio · superficie verniciata a polveri · Lenti spostati indietro con varie emissioni
 Spot à LED en aluminium · surface laquée en poudre · Lentilles décalés au fond avec d'émissions différentes

TRIGGA 1 SD

SYS 11W	LM
662-01104RRWWXX0v1	380 - 470
nicht dimmbar / not dimmable	

TRIGGA 2 SD

SYS 15W	LM
662-01005RRWWXX0v1	610 - 760
nicht dimmbar / not dimmable	

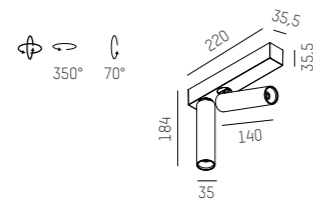
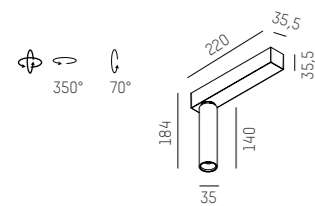

LFO Lens- Technology by Bartenbach

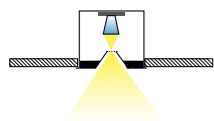

IP20



COMPLETE CODE		
RR = REFLECTOR	WW = LIGHT COLOUR	XX = COLOUR
30° medium = 02	LED 2700K = 23 CRI>90	white = 55
55° flood = 05	LED 3000K = 29 CRI>90	black = 66

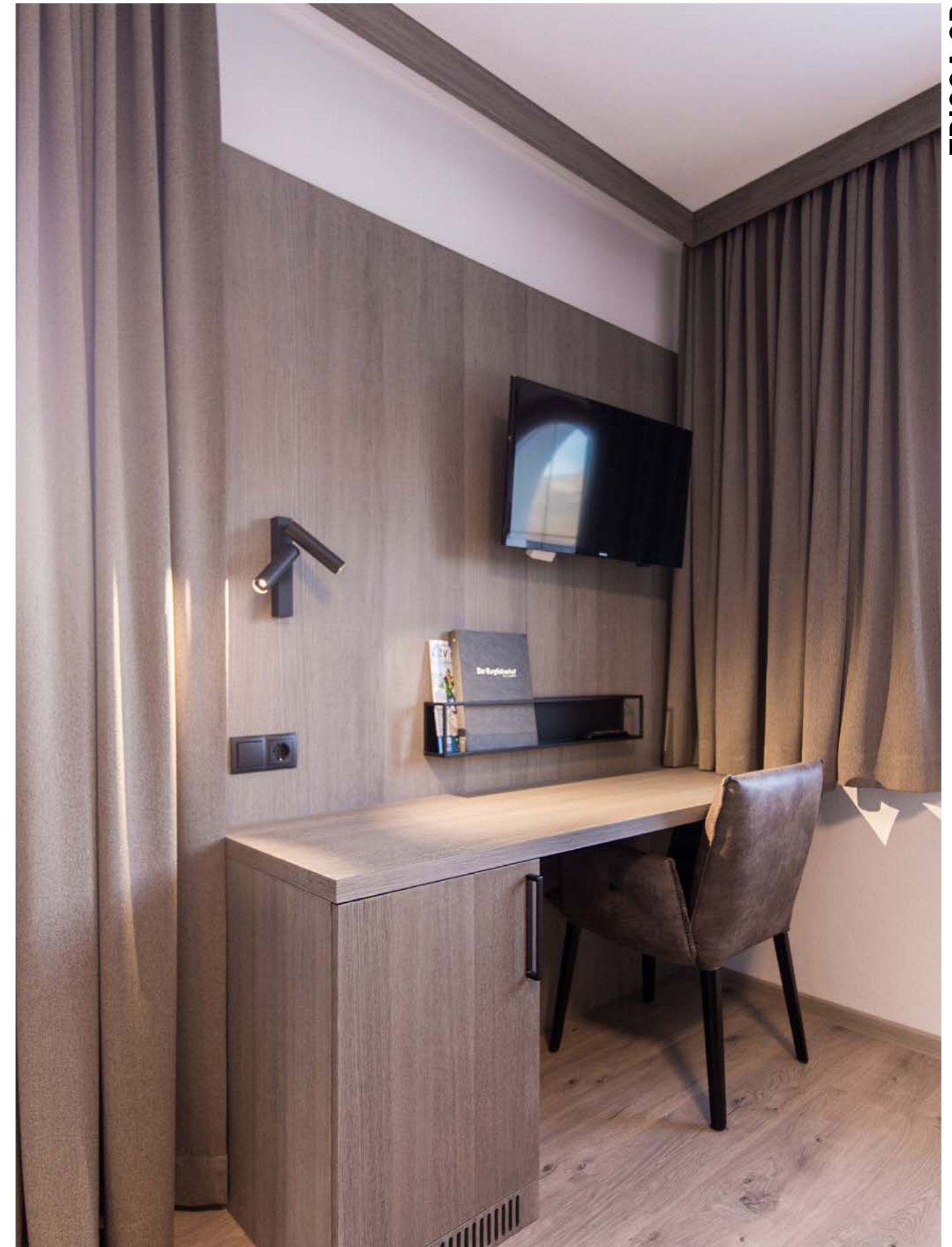

TRIGGA SD

Project: Hotel Burgfellnerhof
 Schladming, Austria
 Photo: Kotrasch Ges.m.b.H

Technical data and energy efficiency



TRIGGA 1 SD



TRIGGA 2 SD



TRIGGA W

220-240V AC 50/60Hz UGR<16

Design: Serge & Robert Cornelissen / INHOUSE

LED Aufbaustrahler aus Aluminium · Oberfläche pulverbeschichtet · Zurückversetzte Linse mit verschiedenen Abstrahlwinkeln
 LED spotlight in aluminium · surface powder-coated · Recessed lenses with different beam-angles
 Faretto a LED in alluminio · superficie verniciata a polveri · Lenti spostati indietro con varie emissioni
 Spot à LED en aluminium · surface laquée en poudre · Lentés déplacés au fond avec d'émissions différentes

SYS 6W	LM
662-01302RRWWXX0v1	230 - 290
inkl. ein - aus Schalter / nicht dimmbar incl. on - off switch / not dimmable	

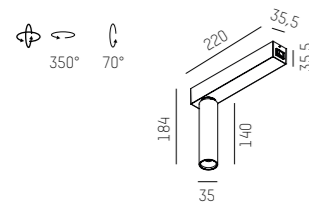

LFO Lens- Technology by Bartenbach

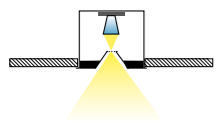

IP20



COMPLETE CODE		
RR = REFLECTOR	WW = LIGHT COLOUR	XX = COLOUR
30° medium = 02	LED 2700K = 23 CRI>90	white = 55
55° flood = 05	LED 3000K = 29 CRI>90	black = 66

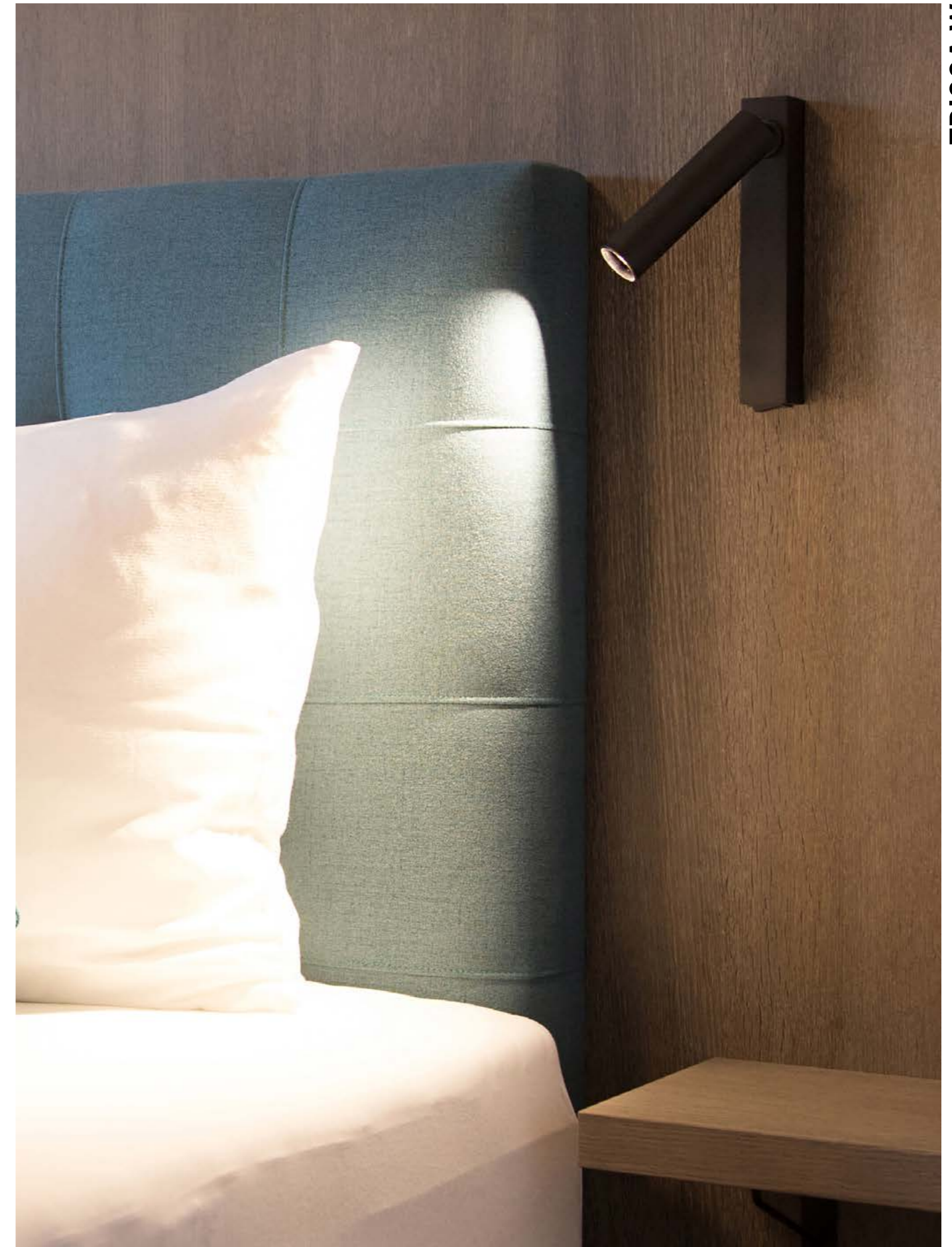

TRIGGA W

Technical data and energy efficiency



TRIGGA W

Project: Hotel Burgfellnerhof
 Schladming, Austria
 Photo: Kotrasch Ges.m.b.H



TRIGGA PD

220-240V AC 50/60Hz UGR<16

Design: Serge & Robert Cornelissen / INHOUSE

LED Pendelleuchte aus Aluminium · Oberfläche pulverbeschichtet · zurückversetzte Linsen mit verschiedenen Abstrahlwinkeln
 LED pendant in aluminium · surface powder-coated · recessed lenses with different beam-angles
 Sospensione a LED in alluminio · superficie verniciata a polveri · Lenti spostati indietro con varie emissioni
 Suspension à LED en aluminium · surface laquée en poudre · Lentilles déplacés au fond avec d'émissions différentes

TRIGGA SHORT PD

SYS 6W	LM
662-00402RRWWXX0	230 - 290
nicht dimmbar / not dimmable	

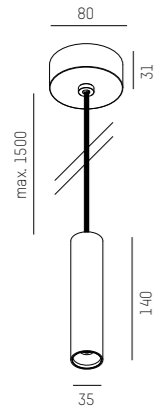

TRIGGA LONG PD

SYS 6W	LM
662-00502RRWWXX0	230 - 290
nicht dimmbar / not dimmable	

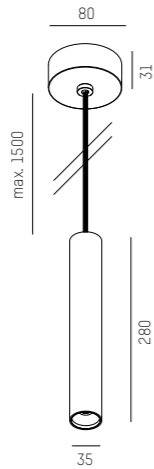

TRIGGA XL PD

SYS 6W	LM
662-02102RRWWXX0	230 - 290
nicht dimmbar / not dimmable	

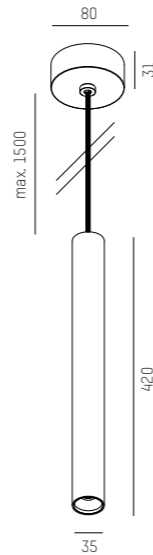

LFO Lens- Technology by Bartenbach

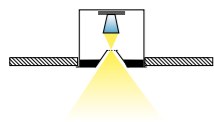

IP20



COMPLETE CODE		
RR = REFLECTOR	WW = LIGHT COLOUR	XX = COLOUR
30° medium = 02	LED 2700K = 23 CRI>90	white = 55
55° flood = 05	LED 3000K = 29 CRI>90	black = 66
		bronze = 68

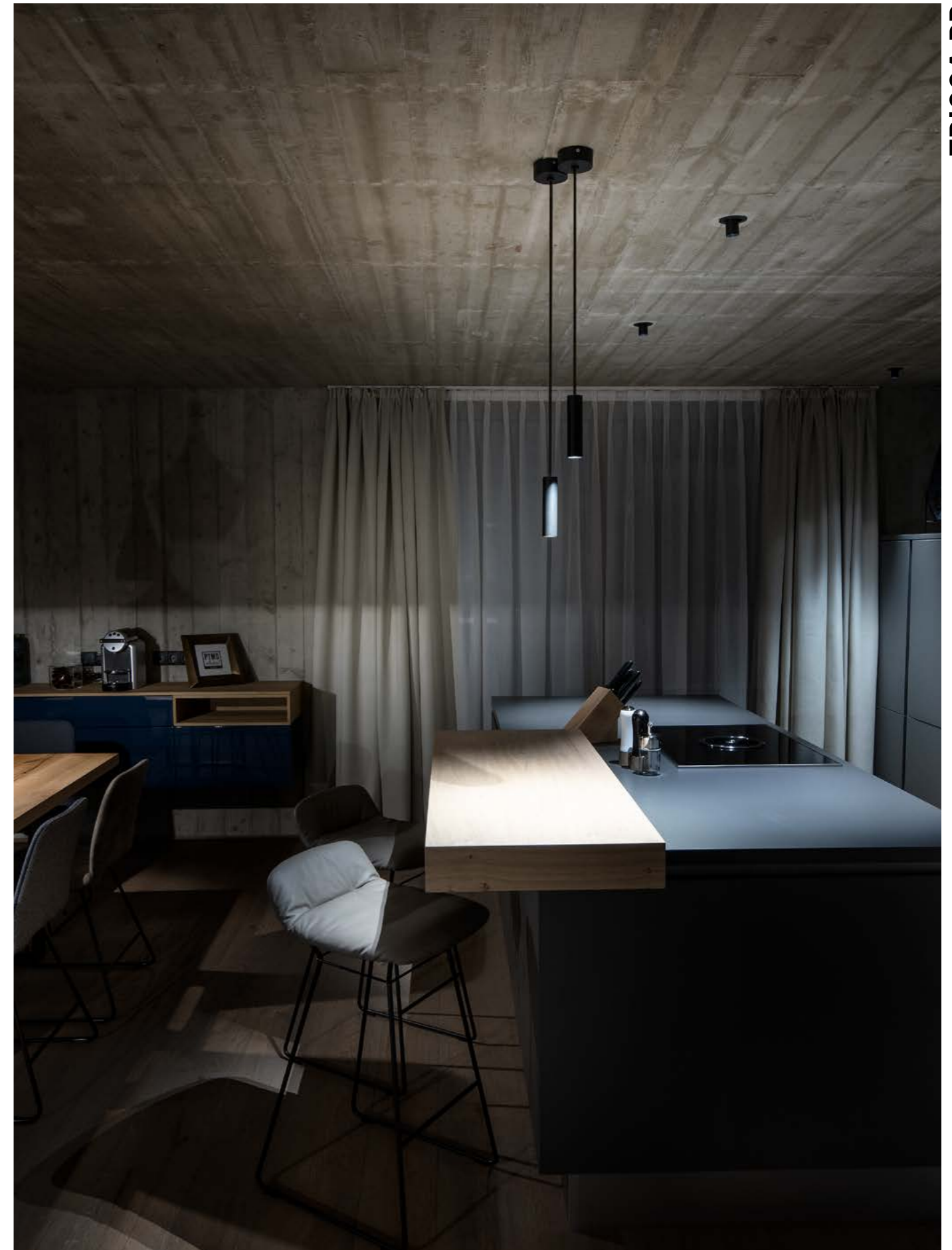

TRIGGA PD

Glanzer Homes
 Längenfeld, Austria
 Photo: hochundquerformat

Technical data and energy efficiency



TRIGGA SHORT PD



TRIGGA LONG PD



TRIGGA XL PD



TRIGGA LOON MINI PD

220-240V AC 50/60Hz UGR<16

Design: Serge & Robert Cornelissen / INHOUSE

LED Pendelleuchte aus Aluminium · Oberfläche schwarz pulverbeschichtet · zurückversetzte Linsen mit verschiedenen Abstrahlwinkeln
 LED pendant in aluminium · surface black powder-coated · recessed lenses with different beam-angles
 Sospensione a LED in alluminio · superficie nero verniciata a polveri · Lenti spostati indietro con varie emissioni
 Suspension à LED en aluminium · surface noir laquée en poudre · Lentilles déplacés au fond avec d'émissions différentes

SYS 6W	LM
662-01702RRWW6X0	230 - 290
nicht dimmbar / not dimmable	

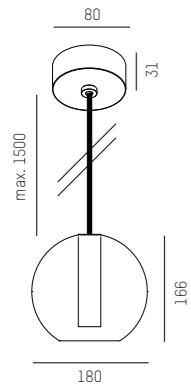

LFO Lens- Technology by Bartenbach

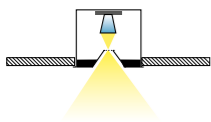

IP20

COMPLETE CODE		
RR = REFLECTOR	WW = LIGHT COLOUR	X = COLOUR GLASS
30° medium = 02	LED 2700K = 23 CRI>90	amber = 7
55° flood = 05	LED 3000K = 29 CRI>90	brown = 8
		grey = 9

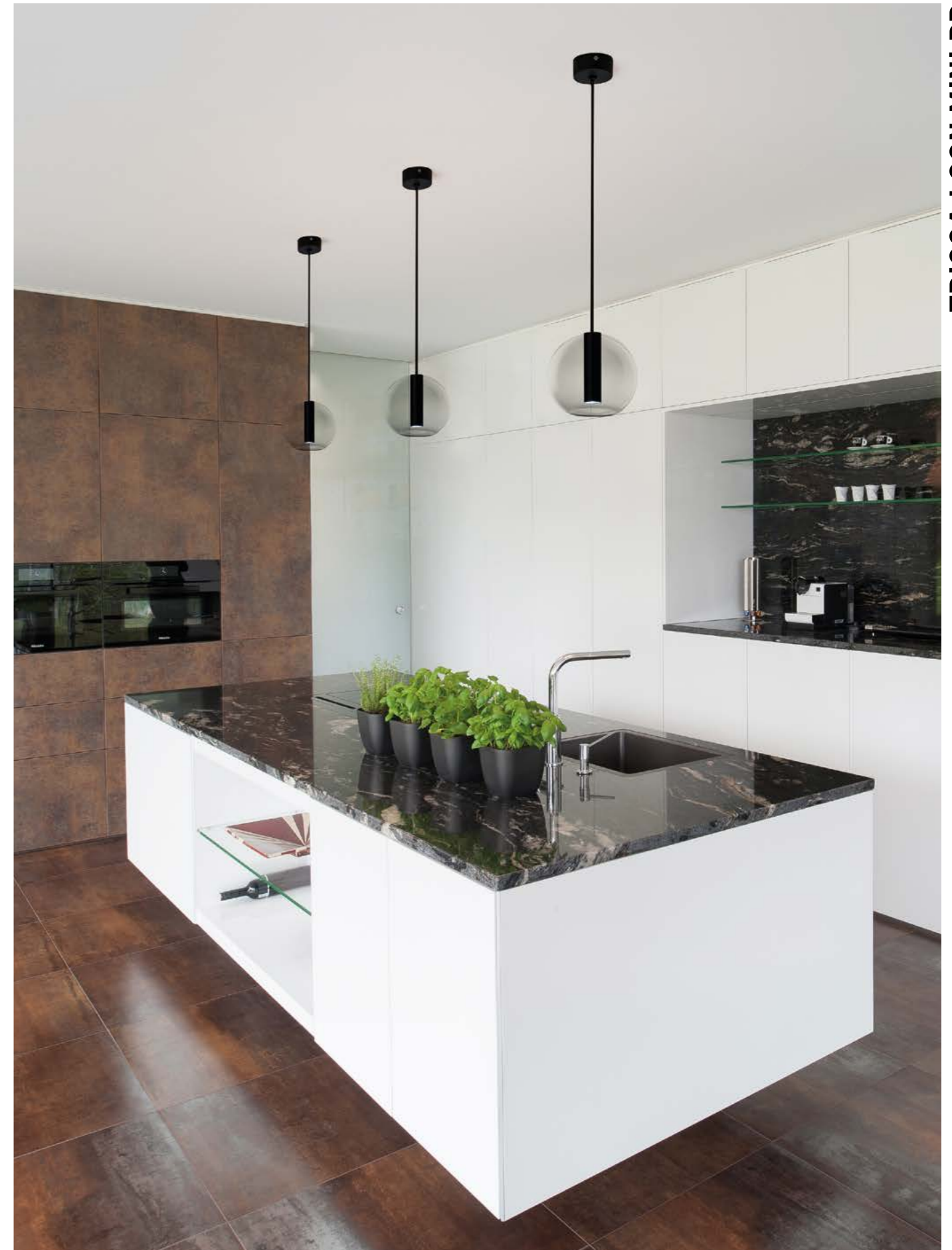

TRIGGA LOON MINI PD

Technical data and energy efficiency

Private residence
Austria
Photo: Joachim Rauch



TRIGGA LOON PD

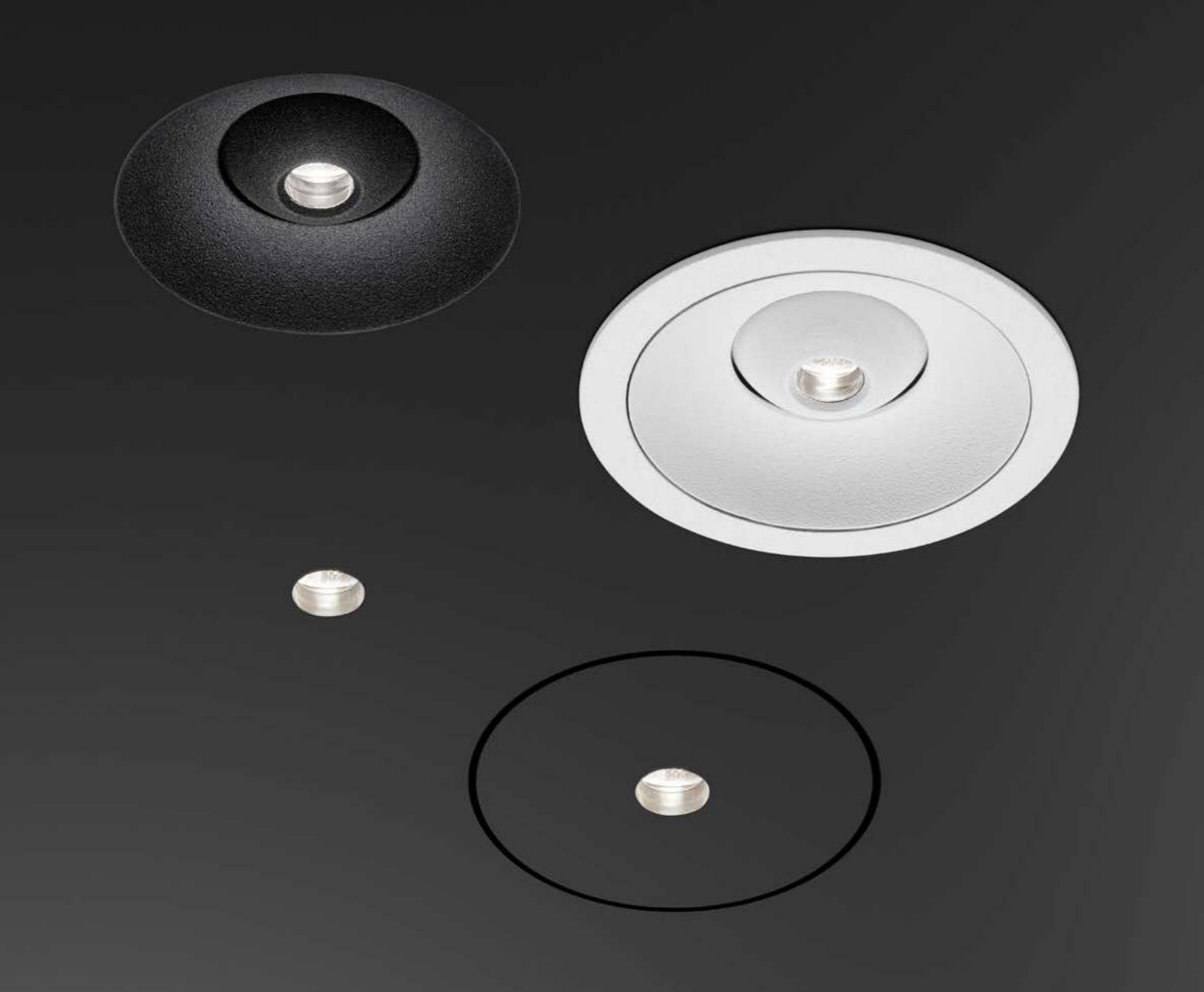

NEW TECHNOLOGY OUT OF THE SMALLEST SPACE

Beinahe unsichtbar bringt BLINDSPOT Beleuchtung in den Raum. Das Licht wird von der speziellen LFO Linse der Marke Bartenbach an der Lichtaustrittsöffnung auf 10mm reduziert und anschließend wieder auf 30° bzw. 55° aufgeweitet. LFO Linsen erzielen zudem beeindruckende Werte bei der Entblendung, was den Sehkomfort deutlich verbessert. Highlight ist die Version mit Mineralfaserplatte, bei der der Spot bis auf eine Lichtaustrittsöffnung von 13,5 mm gänzlich in der Decke verschwindet. Alles was bleibt, ist ein spannendes Lichterlebnis im Raum.

Blindspot brings light into a room almost invisible. The light is reduced to 10mm by the special LFO lens of the Bartenbach brand at the light emission opening and then widened again to 30° or 55°. The impressive glare control of the LFO lens significantly improves visual comfort. Particularly interesting is the version with mineral fiber plate, through which the spot disappears completely into the ceiling up to a light exit opening of 13.5 mm in diameter. All that remains is an exciting lighting experience in the room.

Design: Serge & Robert Cornelissen

BLINDSPOT

Versions

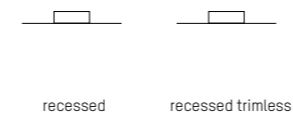

Core Colours



Creative Colours

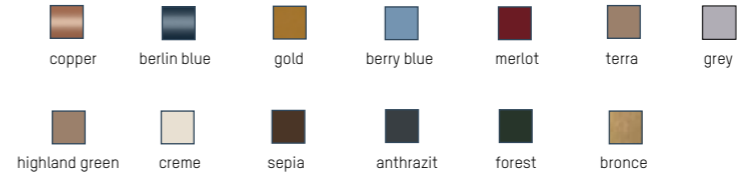

LED Colour

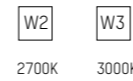

Special



Mounting



Design: Serge & Robert Cornelissen

Mounting video





BLINDSPOT TURN R

Design: Serge & Robert Cornelissen

UGR<16

Einbauspot aus Aluminium · Oberfläche pulverbeschichtet · zurückversetzte Linse mit verschiedenen Abstrahlwinkeln · Lichtaustrittsfläche von nur 10 mm
 Recessed LED spotlight in aluminium · surface powder coated · recessed lenses with different beam-angles · light exit field with only 10 mm
 Incasso LED in alluminio · superficie verniciata a polveri · lenti spostati indietro con varie emissioni · dispositivo d'illuminazione di soli 10 mm
 Encastré en aluminium · surface laquée en poudres · lentes déplacés au fond avec d'émissions différentes · plus que 10mm de surface d'émission de lumière

LED 9W - 700mA	LM
640-00101RRWWXX	400 - 430

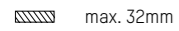
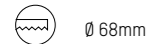
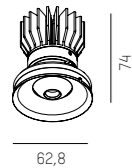
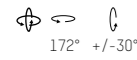

EINBAURAHMEN
RECESSED FRAME

- 640-000035 W
- 640-000036 S



MONTAGERING
MOUNTING RING

640-000010



WERKZEUG ZU MONTAGERING
TOOL FOR MOUNTING RING

640-000020

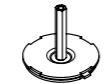

DEMONTAGWERKZEUG
DISASSEMBLING TOOL

640-000040



LED CONVERTER	mA	DIMM	FOR
24-122441	700	not dimmable	1 x BLINDSPOT TURN R
24-151403	700	DALI dimmable	1 x BLINDSPOT TURN R

LF0 Lens- Technology by Bartenbach

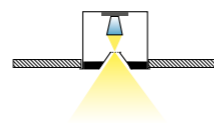

IP20



COMPLETE CODE		
RR = REFLECTOR	WW = LIGHT COLOUR	XX = COLOUR
30° medium = 01	LED 2700K = 23 CRI>90	white = 55
55° flood = 03	LED 3000K = 29 CRI>90	black = 66



BLINDSPOT TURN R

Technical data and energy efficiency



Private residence
Austria
Photo: Joachim Rauch

BLINDSPOT TURN R

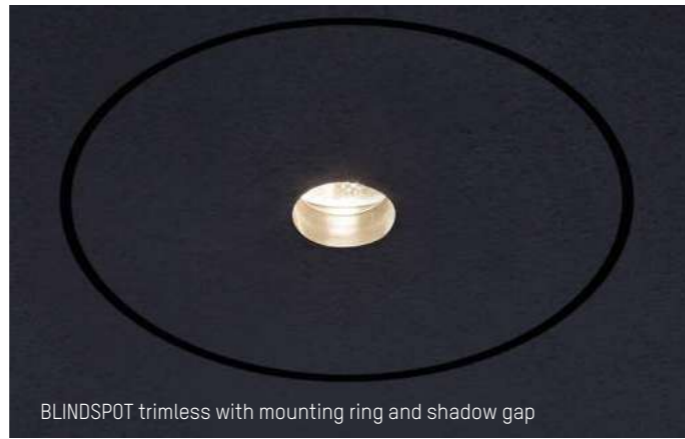

BLINDSPOT R
UGR<16

Design: Serge & Robert Cornelissen

LED Einbauspot aus Aluminium · Oberfläche: Mineralfaserplatte natur, überstreichbar · zurückversetzte Linse mit verschiedenen Abstrahlwinkeln
Trimless recessed LED spotlight in aluminium · surface: mineral fiber board nature, paintable · recessed lense with different beam-angles
Incasto LED a scomparsa in alluminio · superficie in fibra naturale tinteggiabile · lenti spostati indietro con varie emissioni
Encastré LED sans cadre en aluminium · surface en peinteable fibre naturelle · lentes déplacés au fond avec d'émissions différentes

LED 9W - 700mA	LM
640-00201RRWW00	400 - 430

MONTAGERING
MOUNTING RING
640-000010



WERKZEUG ZU MONTAGERING
TOOL FOR MOUNTING RING
640-000020

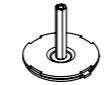

DEMONTAGWERKZEUG
DISASSEMBLING TOOL
640-000040

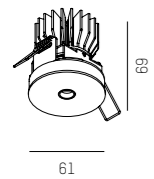

- Ø 68mm
- 100mm
- 12,5 - 32mm

LED CONVERTER	mA	DIMM	FOR
24-122441	700	not dimmable	1 x BLINDSPOT TURN R
24-151403	700	DALI dimmable	1 x BLINDSPOT TURN R

LFO Lens- Technology by Bartenbach

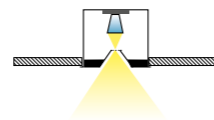

IP20

COMPLETE CODE	
RR = REFLECTOR	WW = LIGHT COLOUR
30° medium = 01	LED 2700K = 23 CRI>90
55° flood = 03	LED 3000K = 29 CRI>90

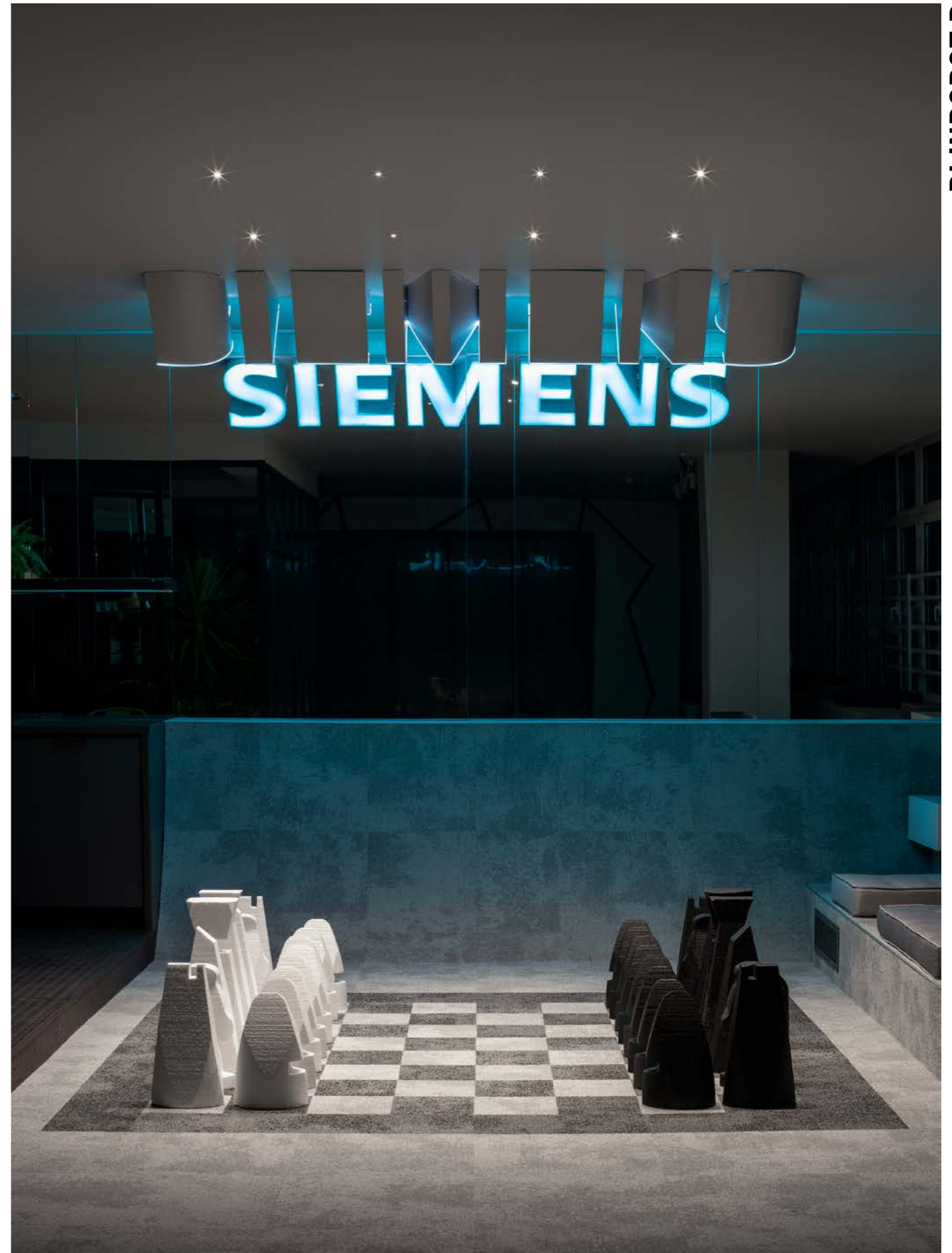

Technical data and energy efficiency



Simens Recreation Area
Sofia, Bulgaria
Photo: Dian Stancer

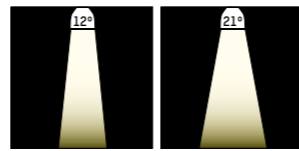

RIDE SPOT R

220-240V AC 50/60Hz

Design: INHOUSE

Schwenkbarer LED Einbauspot aus Aluminium · Oberfläche pulverbeschichtet oder eloxiert · facettierte Linse · Ausführung ein- oder zweiflammig
 Tilting recessed spotlight in aluminium t · surface powder coated or anodised · faceted lenses · single or double headed
 Incasso LED orientabile in alluminio · superficie verniciata a polveri o anodizzata · lente sfaccettata · mono o doppia testa
 Encastré orientable à LED en aluminium · surface laquée en poudre ou anodisée · lentille à facettes · mono ou double spot

RIDE SPOT 1 R

SYS 4W	LM
577-00601RRWWXX0	140 - 160
inkl. Konverter / nicht dimmbar incl. converter / not dimmable	

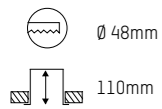
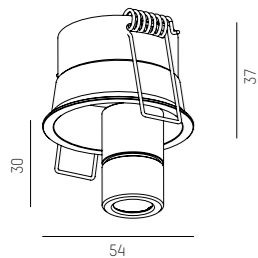

RIDE SPOT 2 R

SYS 7W	LM
577-00602RRWWXXY	290 - 320
inkl. Konverter / incl. converter	

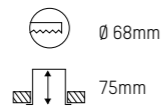
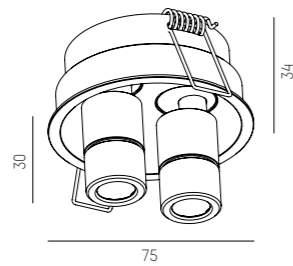

IP20



COMPLRTE CODE			
RR = BEAM ANGLE	WW = LIGHT COLOUR	XX = COLOUR	Y = DIMMABLE
spot 12° = 01	LED 2700K = 23 CRI>90	white = 05	switchable = 0
medium 21° = 02	LED 3000K = 29 CRI>90	black = 06	analog dimm 1-10V = a
	LED 4000K = 24 CRI>90	alu anodized = 08	DALI dimm = d



RIDE SPOT R

Burg Vital Resort
 Lech, Austria
 Photo: Joachim Rauch

Technical data and energy efficiency



RIDE SPOT 1 R



RIDE SPOT 2 R

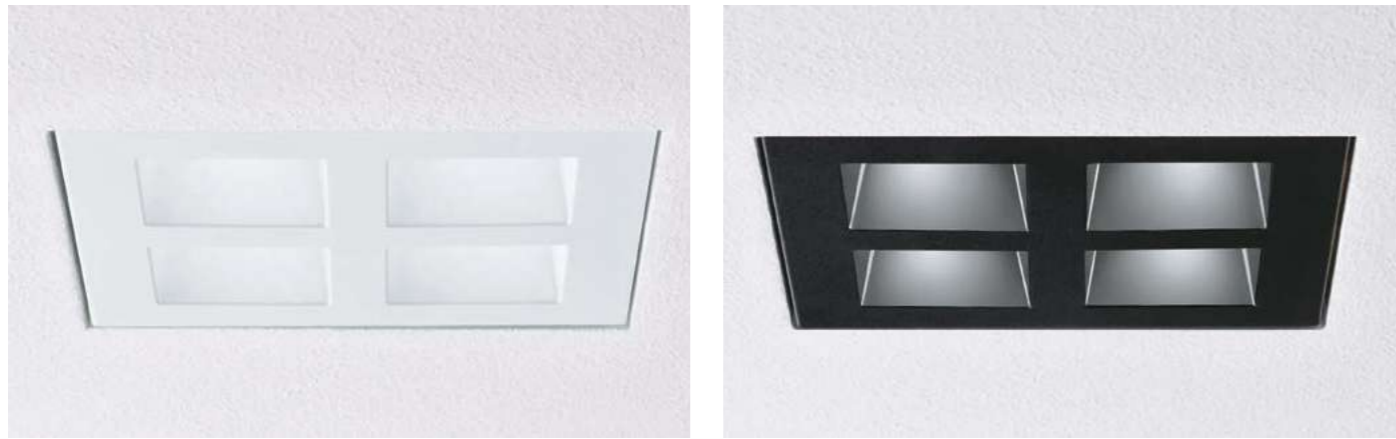

GRID TRIMLESS R

UGR<19

Design: INHOUSE

Rahmenloser LED Einbauspott · Oberfläche pulverbeschichtet · zurückversetzte Linsen · perfekte Entblendung durch Hochglanzraster
 Trimless recessed LED spotlight · surface powder-coated · recessed lenses with different beam-angles · perfect anti-glare due to high-gloss grid
 Incasso LED a scomparsa · superficie verniciata a polveri · lenti spostati indietro con varie emissioni · controllo anti-abbagliato per griglia lucida
 Encastré LED sans cadre · surface laquée en poudre · lentilles décalées au fond avec d'émissions différentes · control anti-éblouie pour grille brillé

GRID R EINBAUBOX RAHMENLOS GRID R RECESSING BOX TRIMLESS

BOX	COLOUR
629-205	white

GRID R LICHTEINSATZ GRID R LIGHT INSERT

LED 9W - 700mA	LM
629-3012RWX	520 - 640

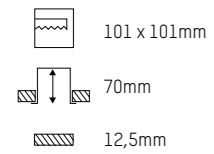
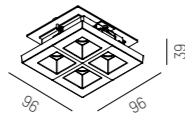
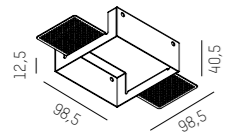

LED CONVERTER	mA	DIMM	FOR
24-122201	700	not dimmable	1 x GRID TRIMLESS R
24-151403	700	DALI dimmable	1 x GRID TRIMLESS R

IP20

COMPLETE CODE		
R = REFLECTOR	W = LIGHT COLOUR	XX = COLOUR
15° spot = 1	LED 2700K = 3 CRI>90	white = 5
30° medium = 2	LED 3000K = 9 CRI>90	black = 6
45° + 15° asymm = 3	LED 4000K = 4 CRI>90	

246



GRID TRIMLESS R

Technical data and energy efficiency



GRID TRIMLESS R

Sporthotel Gut Brandlhof
Saalfelden, Austria
Photo: Joachim Rauch

247

BACK TO CONTENT



Lichteinsatz höhenverstellbar mittels Verstellerschrauben
Light insert height-adjustable with adjusting screw

GRID R
UGR<19

Design: INHOUSE

LED Einbauspots · Oberfläche pulverbeschichtet · zurückversetzte Linsen · perfekte Entblendung durch Hochglanzraster
Recessed LED spotlight · surface powder-coated · recessed lenses with different beam-angles · perfect anti-glare due to high-gloss grid
Incasso LED · superficie verniciata a polveri · lenti spostati indietro con varie emissioni · controllo anti-abbagliato per griglia lucida
Encastré LED · surface laquée en poudre · lentilles décalées au fond avec d'émissions différentes · contrôle anti-éblouissement pour grille brillante

GRID R EINBAUBOX
GRID R RECESSING BOX

BOX
629-10X

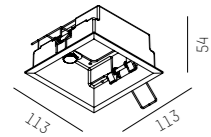

- 106 x 106mm
- 90mm
- 8 - 30mm

GRID R LICHTEINSATZ
GRID R LIGHT INSERT

LED 9W - 700mA	LM
629-3012RWX	520 - 640

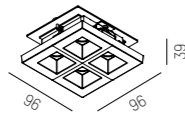

UNIVERSAL BETONEINBAUGEHÄUSE
UNIVERSAL CONCRETE HOUSING

GEHÄUSE / HOUSING	MATERIAL
332-1001	zinc-plated

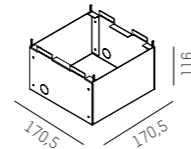

ABDECKUNG QUADRATISCH inkl. Zentrierteil
COVER SQUARE inkl. centering

FÜR GEHÄUSE / FOR HOUSING	MATERIAL
332-1502	zinc-plated
nicht geeignet für Sichtbeton not adapted for exposed concrete	

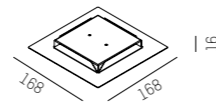

- 106 x 106mm

LED CONVERTER	mA	DIMM	FOR
24-122201	700	not dimmable	1 x GRID R
24-151403	700	DALI dimmable	1 x GRID R

IP20



COMPLETE CODE		
R = REFLECTOR	W = LIGHT COLOUR	XX = COLOUR
15° spot = 1	LED 2700K = 3 CRI>90	white = 5
30° medium = 2	LED 3000K = 9 CRI>90	black = 6
45° + 15° asymm = 3	LED 4000K = 4 CRI>90	



Technical data and energy efficiency



GRID R

Restaurant Fortino
Wels, Austria
Photo: Joachim Rauch



GRID TURN R

220-240V AC 50/60Hz UGR<19

Design: INHOUSE

LED Halbeinbaustrahler aus Aluminium · Oberfläche pulverbeschichtet · zurückversetzte Linsen · perfekte Entblendung durch Hochglanzraster
 Semi-recessed LED spotlight in aluminium · surface powder-coated · recessed lenses · perfect anti-glare due to high-gloss grid
 Semi-incasso a LED in alluminio · superficie verniciata a polveri · lenti spostati indietro · controllo anti-abbagliato per griglia lucida
 Semi-encastré à LED en aluminium · surface laquée en poudre · lentes déplacés au fond · control anti-éblouié pour grille brillé

SYS 10W	LM
629-4012RWXXYYY	520 - 640
inkl. Konverter / incl. converter	

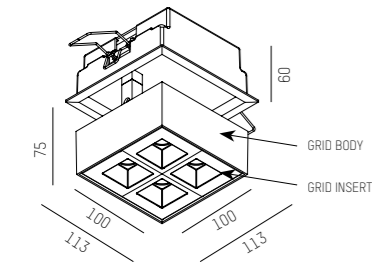

- 106 x 106mm
- 90mm
- 8 - 30mm

IP20



COMPLETE CODE				
R = REFLECTOR	W = LIGHT COLOUR	X = COLOUR BODY	X = COLOUR GRID INSERT	YYY = DIMMABLE
15° spot = 1	LED 2700K = 3 CRI>90	white = 5	white = 5	switchable = no addition
30° medium = 2	LED 3000K = 9 CRI>90	black = 6	black = 6	DALI dimm. = code + ddd
45° + 15° asymm = 3	LED 4000K = 4 CRI>90			



Technical data and energy efficiency



Brautschatz
 Götzis, Austria
 Photo: Joachim Rauch



GRID SD / GRID TURN SD

220-240V AC 50/60Hz UGR<19

Design: INHOUSE

LED Aufbaustrahler aus Aluminium · Oberfläche pulverbeschichtet · zurückversetzte Linsen · perfekte Entblendung durch Hochglanzraster
 LED spotlight in aluminium · surface powder-coated · recessed lenses · perfect anti-glare due to high-gloss grid
 Faretto a LED in alluminio · superficie verniciata a polveri · lenti spostati indietro · controllo anti-abbagliato per griglia lucida
 Spot à LED en aluminium · surface laquée en poudre · lentilles déplacées au fond · contrôle anti-éblouie pour grille brillée

GRID SD

SYS 10W	LM
629-5012RWXX	520 - 640

inkl. Konverter / incl. converter

GRID TURN SD

SYS 10W	LM
629-6012RWXX	520 - 640

inkl. Konverter / incl. converter

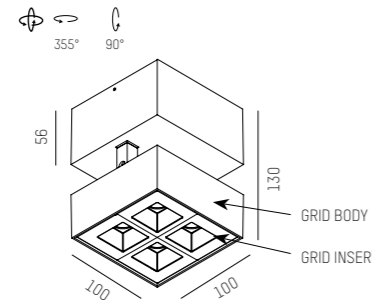
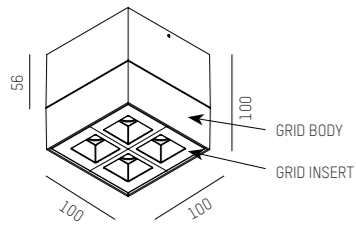

IP20



COMPLETE CODE				
R = REFLECTOR	W = LIGHT COLOUR	X = COLOUR BODY	X = COLOUR GRID INSERT	YYY = DIMMABLE
15° spot = 1	LED 2700K = 3 CRI>90	white = 5	white = 5	switchable = only code without YYY
30° medium = 2	LED 3000K = 9 CRI>90	black = 6	black = 6	DALI dimm. = code + ddd
45° + 15° asymm = 3	LED 4000K = 4 CRI>90			

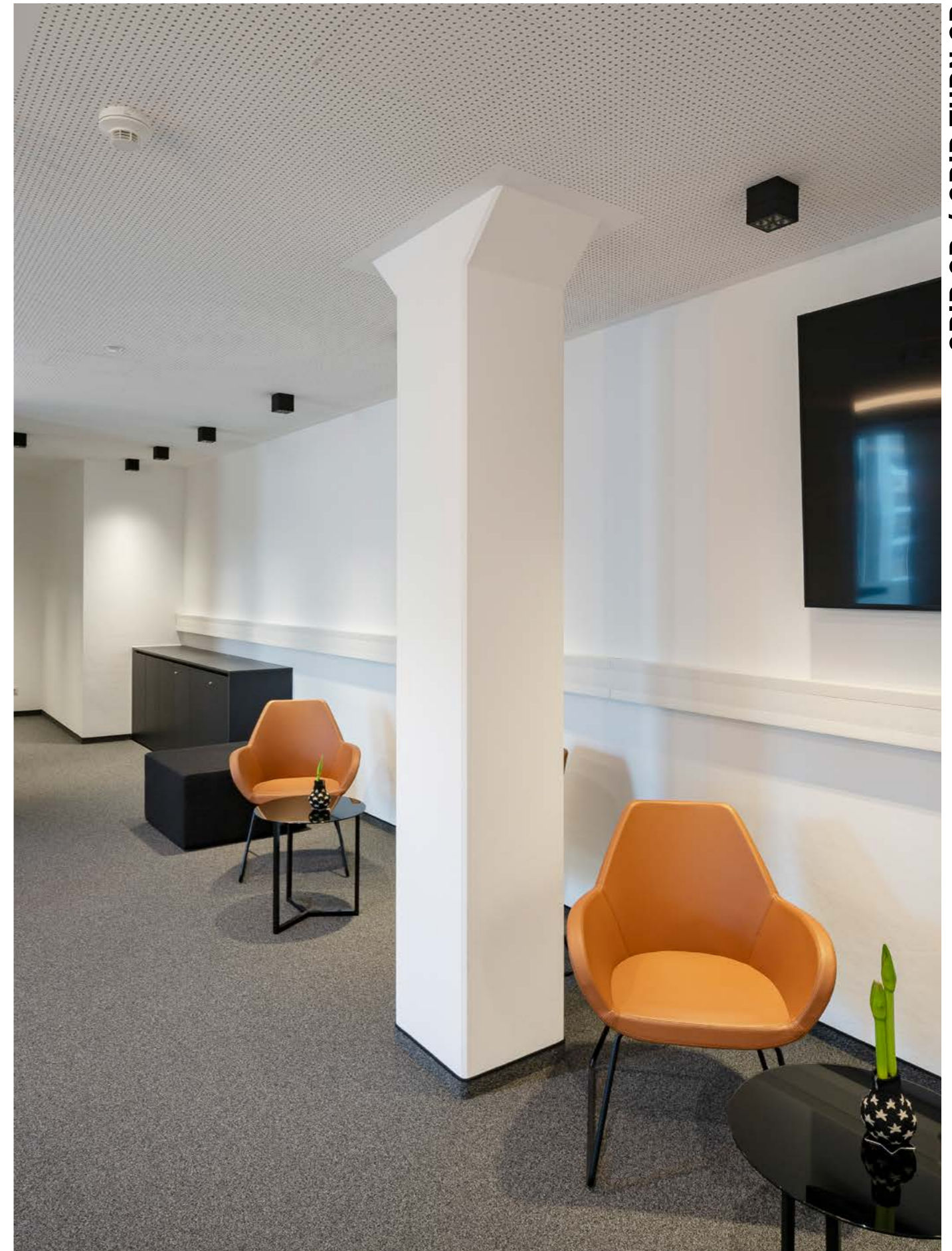

GRID SD / GRID TURN SD

Molto Luce
 Weißkirchen, Austria
 Photo: Joachim Rauch

Technical data and energy efficiency



GRID SD



GRID TURN SD



Versions

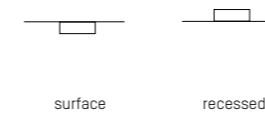

Core Colours



Creative Colours

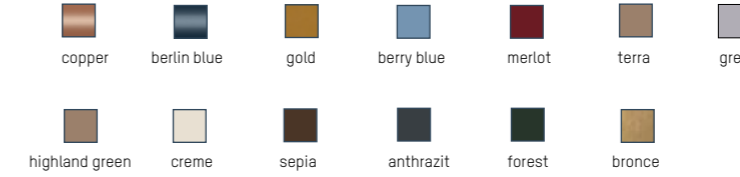

LED Colour



Special



REVIVAL OF QR111

Die klassische QR111 war in ihrer Brillanz und Lichtlenkung einzigartig und unverkennbar. Vibo setzt genau dort wieder an, schafft allerdings mit seiner neuen Lichttechnik den Spagat zwischen den positiven Aspekten der QR111 und maximaler Effizienz. Eine optimale Beleuchtung wird durch die wählbaren Ausstrahlwinkel von 10°, 23° und 34° bestens unterstützt. Formal geht der Strahler mit einer konvex geformten Außenseite einen eigenständigen, selbstbewussten Weg. Auch farblich kann Vibo einiges bieten: durch einen austauschbaren Dekorring können vier unterschiedliche Farbvarianten zusammengestellt werden. Vibo ist in jedem Bereich einsetzbar und meistert die Beleuchtungsaufgaben mit Bravour. Erhältlich ist Vibo als Einbau- & Aufbauvariante und kann mit Dali gesteuert werden.

The sheer brilliance and unique light control of the classic QR111 made it quite unmistakable. The Vibo continues in the same vein, taking advantage of new lighting technology to combine the positive aspects of the QR111 with maximum efficiency. Optimal lighting is perfectly supported by the choice of angles - 10°, 23° and 34°. With its convex exterior, the spotlight cuts a distinctive and bold figure. The Vibo also has something to offer in terms of colour. The interchangeable decorative rings allow you to create four different colour combinations. Vibo can be used in every area and masters lighting tasks with flying colours. Vibo is available as a recessed and surface luminaire and can be controlled with Dali.

Design: INHOUSE

VIBO



VIBO R

UGR<16

Design: INHOUSE

Einbaustrahler aus Aluminium · Oberfläche pulverbeschichtet · spezielle Linsenoptik ohne Streulicht · Dekoring pulverbeschichtet
 Recessed spotlight in aluminium · surface powder-coated · special lens optics without scattered light · decoration ring powder-coated
 Incasso in alluminio · superficie verniciata a polveri · ottica speciale senza luce diffusa · anello decorativo verniciato a polvere
 Encastré en aluminium · surface laquée en poudre · lentille optique sans lumière parasite · anneau décoratif laquée en poudre

LED 6W - 500mA	LM
668-00301RRWWXX	340 - 470

DEKORRING für 2 färbige Versionen DECOR RING for bi-coloured versions	FARBE COLOUR
668-000105	white
668-000106	black

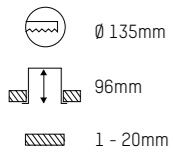
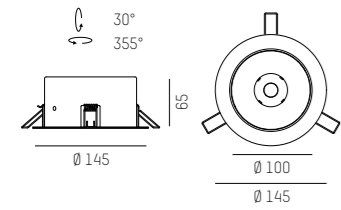

LED CONVERTER	mA	DIMM	FOR
24-122602	500	not dimmable	1 x VIBO R
24-151403	500	DALI dimmable	1 x VIBO R

IP20



COMPLETE CODE		
RR = REFLECTOR	WW = LIGHT COLOUR	XX = COLOUR
10° spot = 02	LED 2700K = 23 CRI>90	white = 55
23° medium = 05	LED 3000K = 29 CRI>90	black = 66
35° flood = 08	LED 4000K = 24 CRI>90	

256



VIBO R

For technical data and energy efficiency



VIBO R

257

BACK TO CONTENT



VIBO SD

220-240V AC 50/60Hz UGR<16

Design: INHOUSE

Aufbaustrahler aus Aluminium · Oberfläche pulverbeschichtet · spezielle Linsenoptik ohne Streulicht · Dekoring pulverbeschichtet
 Surface mounted spotlight in aluminium · surface powder-coated · special lens optics without scattered light · decoration ring powder-coated
 Faretto da soffitto in alluminio · superficie verniciata a polveri · ottica speciale senza luce diffusa · anello decorativo verniciato a polvere
 Spot au plafond en aluminium · surface laquée en poudre · lentille optique sans lumière parasite · anneau décoratif laquée en poudre

SYS 8W	LM
668-00101RRWWXX0	340 - 470
nicht dimmbar / not dimmable	

SYS 8W	LM
668-00201RRWWXXd	340 - 470
DALI dimmbar / DALI dimmable	

DEKORRING für 2 färbige Versionen	FARBE
DECOR RING for bi-coloured versions	COLOUR
668-000105	white
668-000106	black

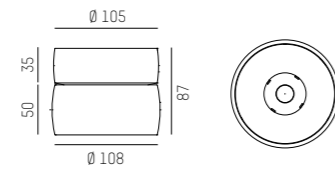
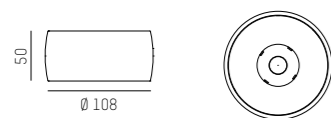

IP20 Ⓢ CE



COMPLETE CODE		
RR = REFLECTOR	WW = LIGHT COLOUR	XX = COLOUR
☐ 10° spot = 02	☐ W2 LED 2700K = 23 CRI>90	☐ W white = 55
☐ 23° medium = 05	☐ W3 LED 3000K = 29 CRI>90	☐ S black = 66
☐ 35° flood = 08	☐ W4 LED 4000K = 24 CRI>90	

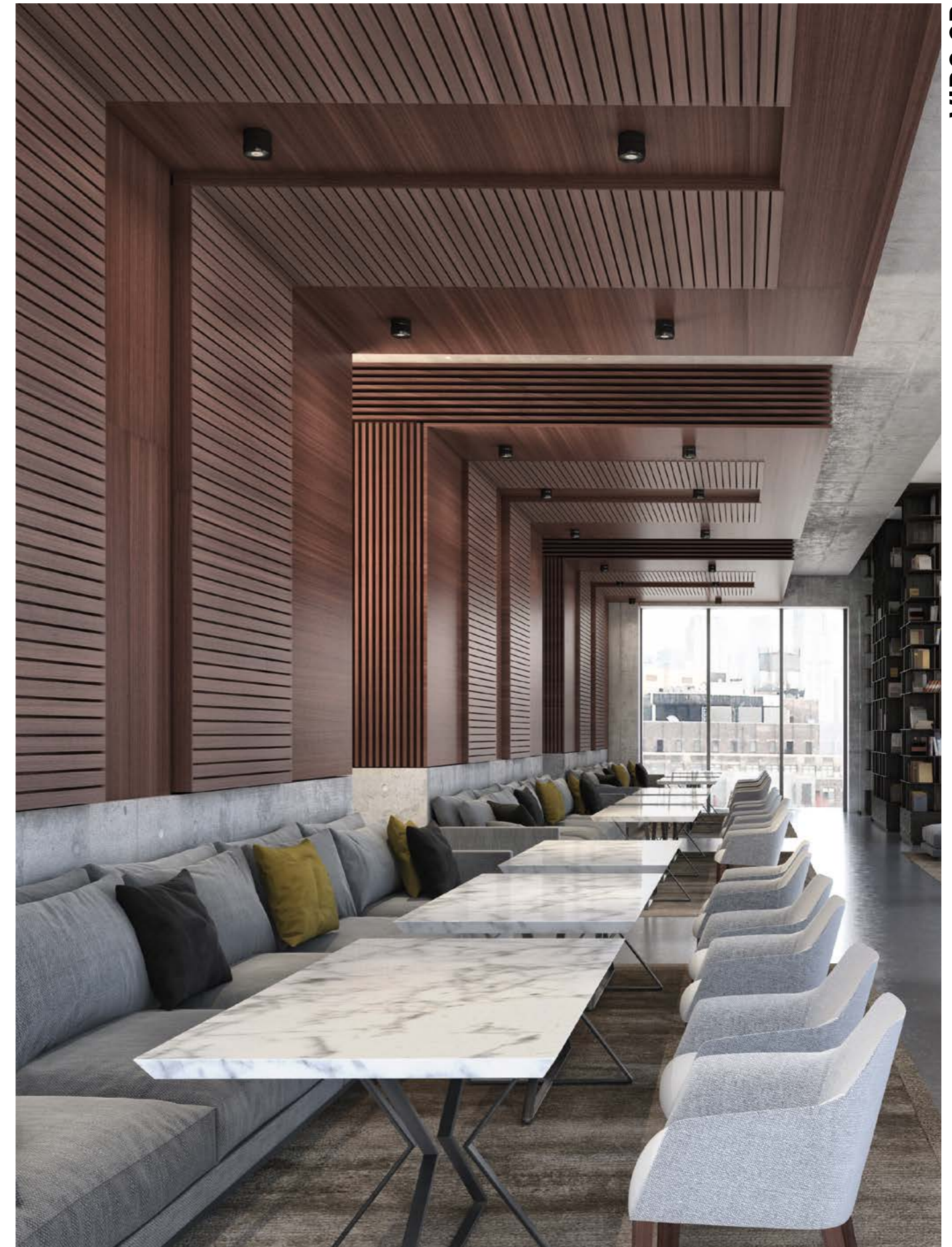

VIBO SD

For technical data and energy efficiency



VIBO SD



VIBO SD DIMMABLE

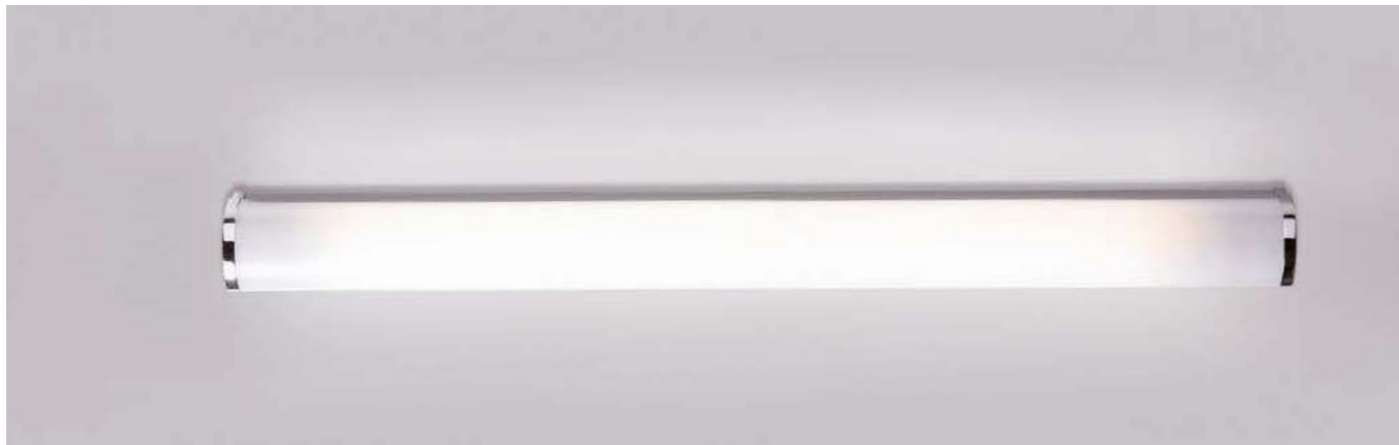

MICA IP44 SD

220-240V AC / DC 50/60Hz LED 3000K / CRI>80 Design: INHOUSE

OPAL DIFFUSER

LED Aufbauteuchte aus Aluminiumprofil · Oberfläche lackiert · Opale PMMA Abdeckung zylindrisch
 LED surface luminaire from aluminium profile · surface painted · opal PMMA diffuser curved
 Lampada LED a plafone con profilo in alluminio · Superficie verniciata · Diffusore PMMA cilindrico
 Plafonnier LED en profilé d'aluminium · surface lacquée · Diffuseur PMMA opal cylindrique

SYS 15W	L: 606mm	LM	SYS 21W	L: 904mm	LM
520-019XY		1090	520-029XY		1640

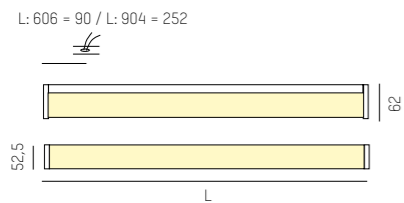

IP44

COMPLETE CODE	
X = COLOUR	YY = DIMMABLE
chrome = 1	switchable = no addition
grey = 4	Analog dimm. 1 - 10V = code + ad

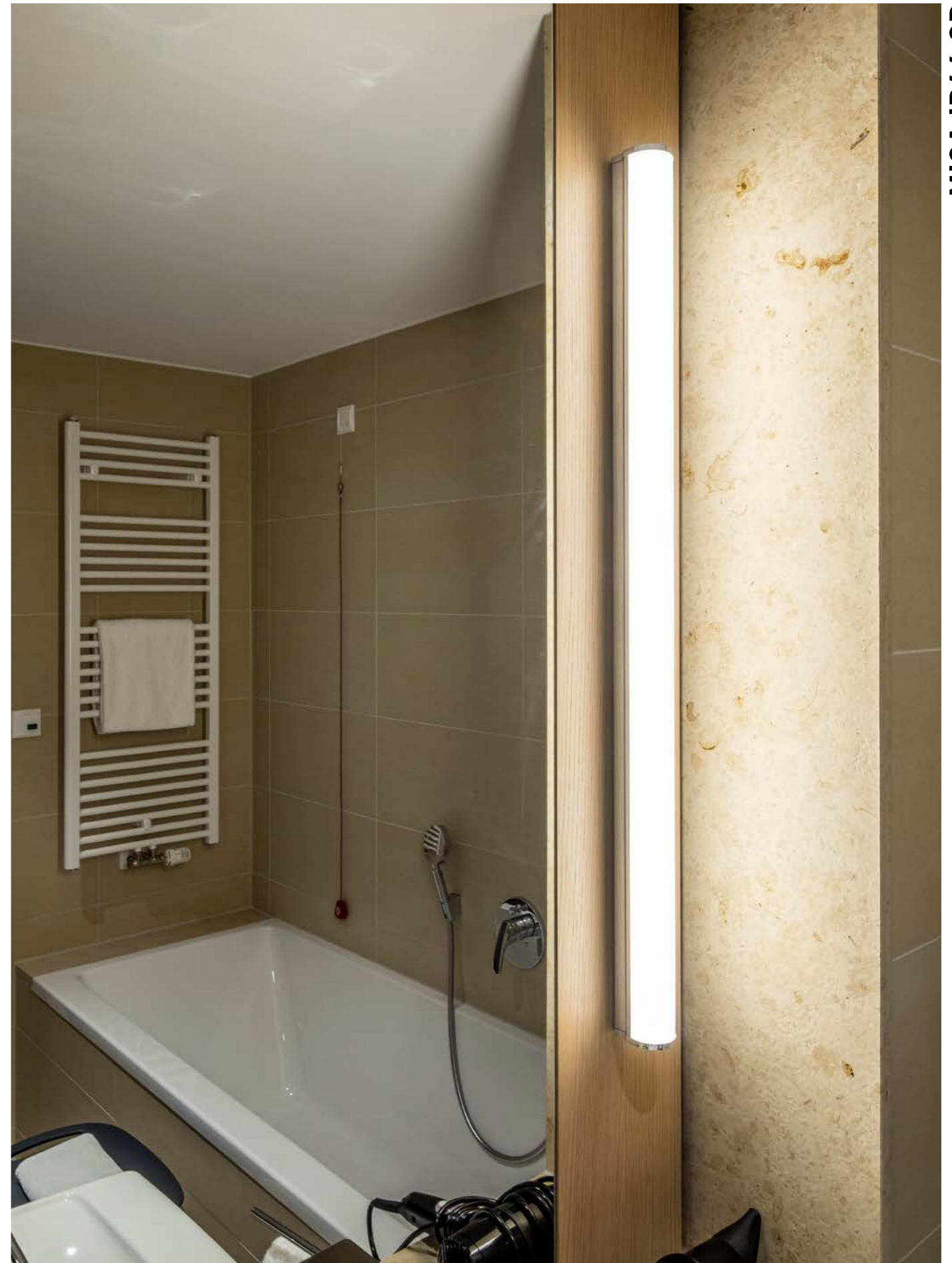

MICA IP44 SD

Technical data and energy efficiency



MICA IP44 SD

Ideamed GmbH
 Munich Germany
 Photo: Alexander Schwarz

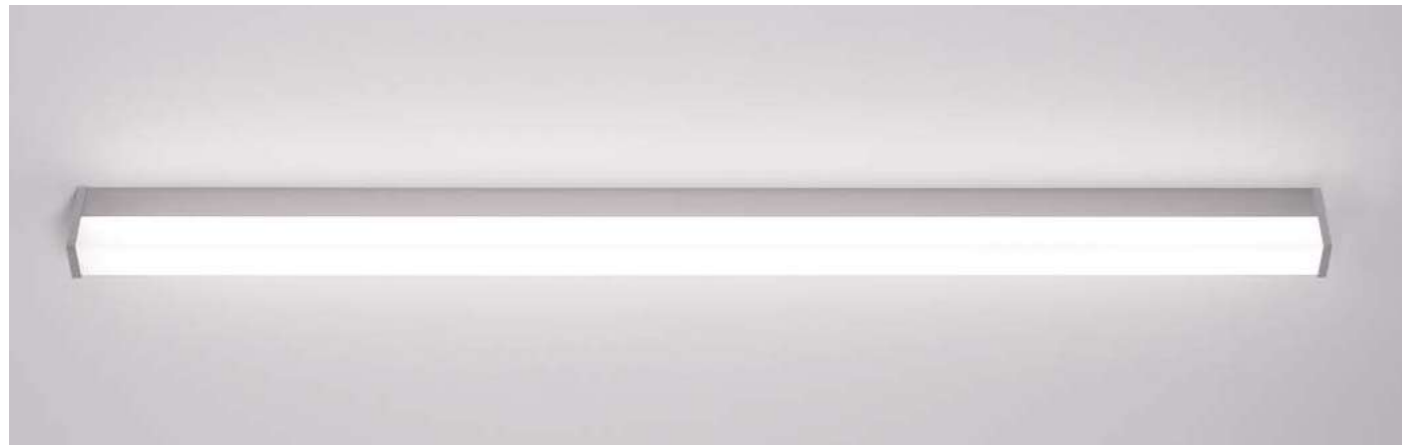

PARI SD OPAL DIFFUSER
 220-240V AC / DC 50/60Hz LED 3000K / CRI>80 Design: INHOUSE

LED Aufbauteuchte aus Aluminiumprofil · Oberfläche lackiert oder eloxiert · Opale PMMA Abdeckung kubisch
 LED surface luminaire from aluminium profile · surface painted or anodized · opal PMMA diffuser cubic
 Lampada LED a plafone con profilo in alluminio · Superficie verniciata o anodizzata · Diffusore PMMA opale cubico
 Plafonnier LED en profilé d'aluminium · surface lacquée ou anodisée · Diffuseur PMMA opal cubique

SYS 15W	L: 600mm	LM	SYS 21W	L: 900mm	LM	SYS 28W	L: 1200mm	LM
576-019XY		1460	576-029XY		2190	576-039XY		2920

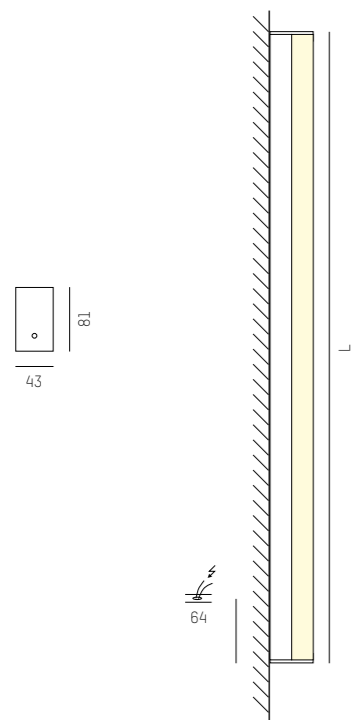

IP43

COMPLETE CODE	
X = COLOUR	Y = DIMMABLE
chrome = 1	switchable = no addition
white = 5	Analog dimm. 1 - 10V = code + ad
alu anodized = 8	

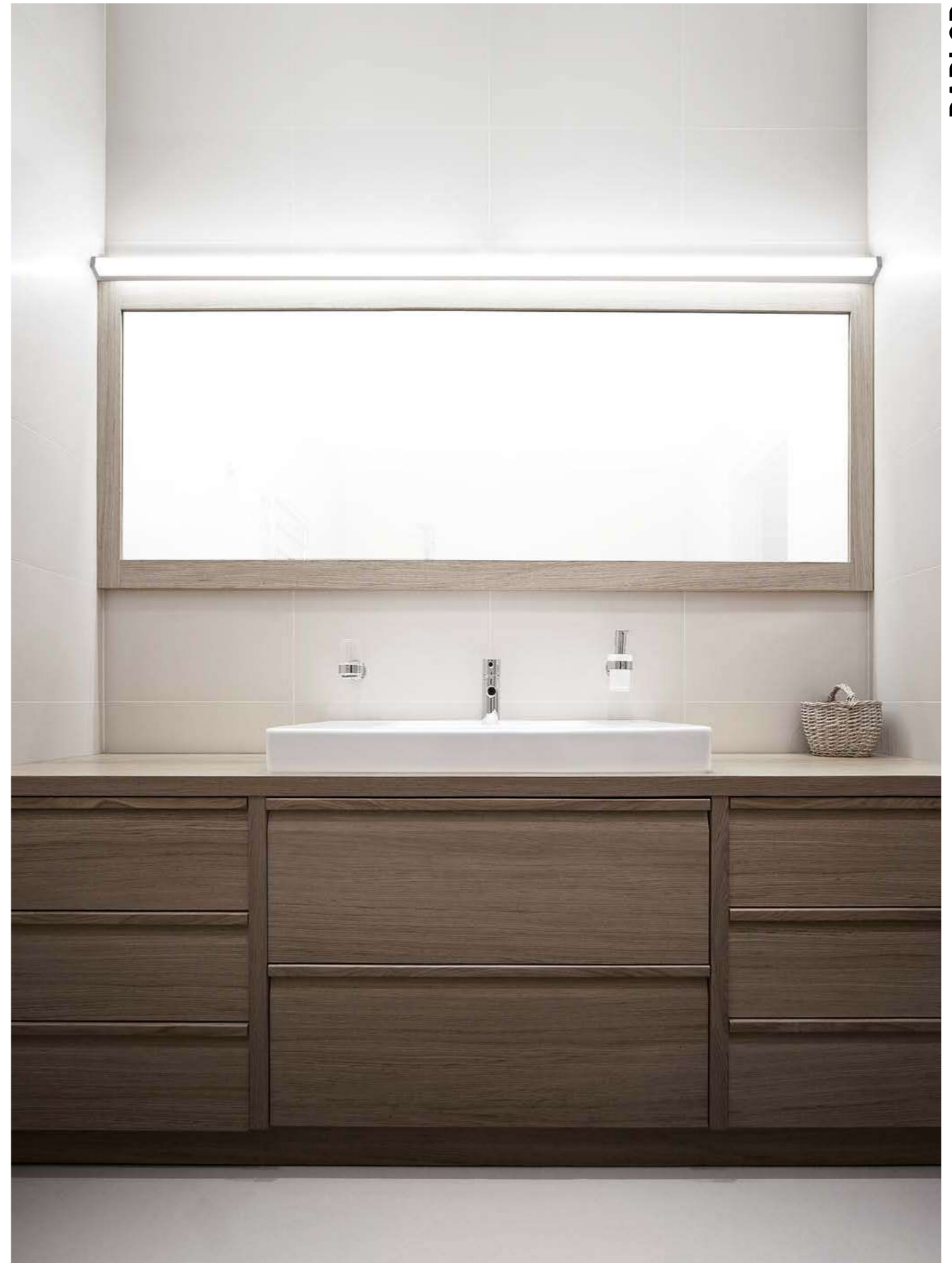

Technical data and energy efficiency





VOLTO COPERTO SD

220-240V AC 50/60Hz Design: INHOUSE

OPAL DIFFUSER

LED Aufbauleuchte aus Aluminiumprofil · Oberfläche pulverbeschichtet oder eloxiert · Opale PMMA Abdeckung kubisch, flach oder rund
 LED surface luminaire from aluminium profile · surface powder-coated or anodized · opal PMMA diffuser cubic, flat or round
 Lampada LED a plafone con profilo in alluminio · Superficie verniciata a polveri o anodizzata · Diffusore PMMA opale cubico, piatto o tondo
 Plafonnier LED en profilé d'aluminium · surface lacquée en poudre ou anodisée · Diffuseur PMMA opal cubique, plat ou rond

SYS 11W	L: 570mm	LM
539-01001COWWXXO		680 - 810
nicht dimmbar / not dimmable		

SYS 16W	L: 850mm	LM
539-01002COWWXXO		1020 - 1210
nicht dimmbar / not dimmable		

SYS 21W	L: 1130mm	LM
539-01003COWWXXO		1360 - 1620
nicht dimmbar / not dimmable		

SYS 26W	L: 1410mm	LM
539-01004COWWXXO		1700 - 2020
nicht dimmbar / not dimmable		



IP20 CE



COMPLETE CODE	WW = LIGHT COLOUR	XX = COLOUR
C = COVER		
opal flat = 1	W2 LED 2700K = 23 CRI>90	W white = 05
opal cubic = 2	W3 LED 3000K = 29 CRI>90	S black anodized = 06
opal round = 3	W4 LED 4000K = 24 CRI>90	AE alu anodized = 08

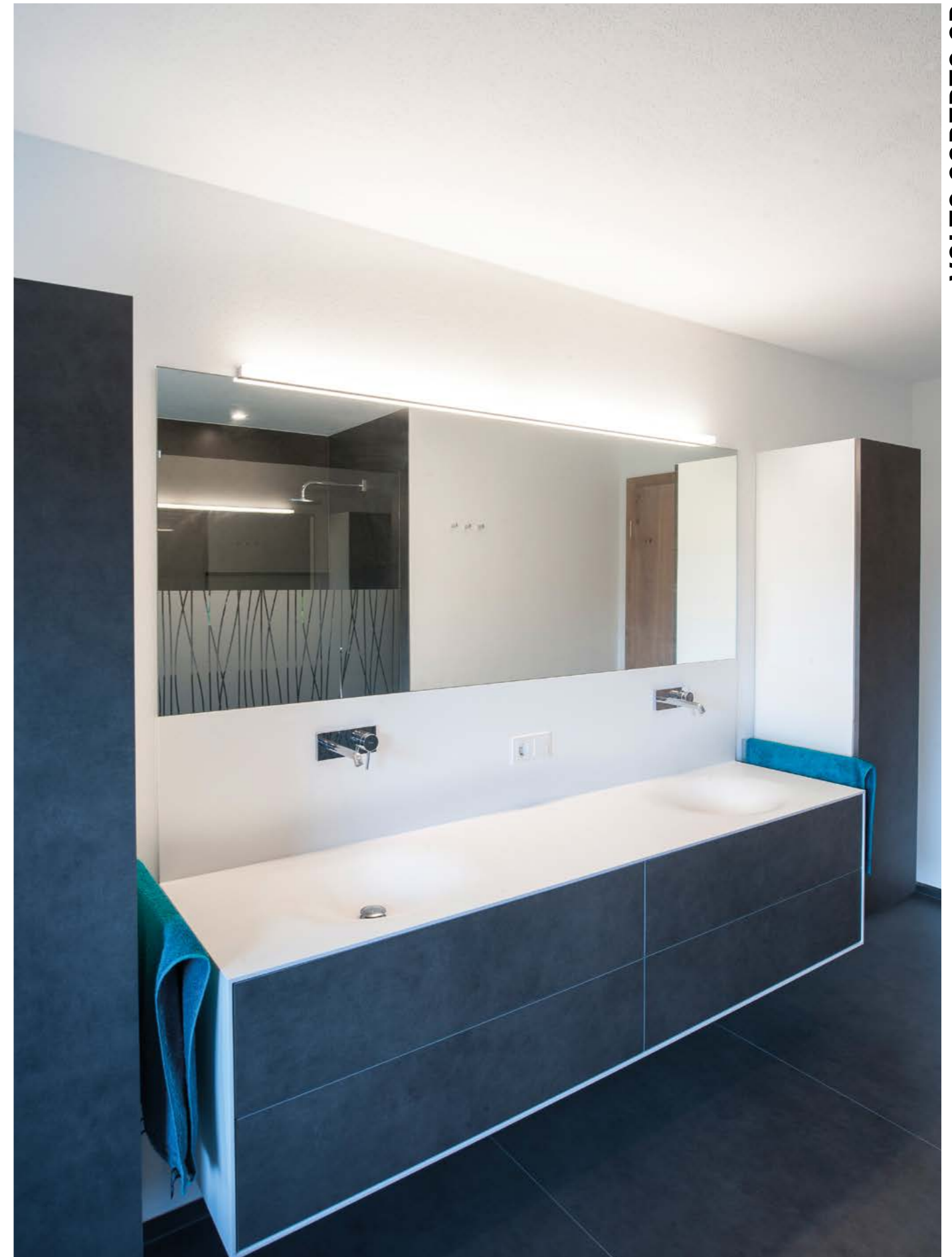

VOLTO COPERTO SD

Technical data and energy efficiency



Private residence
Austria
Photo: Joachim Rauch

VOLTO COPERTO SD



MORE VARIATIONS. MORE FLEXIBILITY.

Zehn Millionen Möglichkeiten, Modernste Technik & Klares Design - unsere flexible Strahler-Plattform setzt Maßstäbe. Der frei konfigurierbare Strahler bringt Varianten-Vielfalt, höchste Flexibilität und maximale Nachhaltigkeit aus nur einem Strahlerkopf. Auf diese Weise kann MOVA perfekt an unterschiedliche Anforderungen angepasst werden, ohne das Erscheinungsbild der jeweiligen Architektur verändern zu müssen. Dies ermöglicht eine ressourcenschonendere Beleuchtungslösung. Verschiedenste Accessoires ermöglichen eine noch bessere Entblendung, sowie zusätzliche Lichtszenarien für Spezialanwendungen.

Ten million possibilities, state-of-the-art technology and clear design - our flexible spotlight platform creates a milestone. The freely configurable spotlight offers a wide variety, highest flexibility and maximum sustainability, all of which with only one spotlight head. This is how MOVA can be perfectly adapted to different requirements without changing the overall appearance of the architecture, resulting in a more resource-efficient illumination. Various accessories provide an even better glare control as well as additional light scenarios for special applications.

Design: INHOUSE

MOVA



SIMPLY ADVANTAGEOUS

Eine Reihe von Vorteilen sind mit der wechselbaren LED verbunden. Selbstverständlich denkt man in erster Linie an den Austausch defekter LEDs nach Ende ihrer Lebenszeit, doch dies hat bei den langen Zyklen eher untergeordnete Bedeutung.



Einfacherer Generationenwechsel

Hersteller von COBs bringen im Schnitt alle 2-3 Jahre eine neue Generation von Platinen auf den Markt. Damit verbunden sind deutliche Effizienzsteigerungen, da weniger Strom bei gleichzeitig mehr Lumenoutput verbraucht wird. Die Molto Luce X-Change Technology ermöglicht, rasch auf neue COB-Generationen umzusteigen und davon wirkungs- und kostenseitig zu profitieren.



Unkomplizierte Adaption an sich ändernde Anforderungen

Durch die Molto Luce X-Change-Technology ist ein werkzeugloses Anpassen der Strahler an veränderte Beleuchtungsaufgaben möglich. Mit ein paar wenigen Handgriffen kann das COB-Modul oder auch der Reflektor getauscht werden. Eine andere Lichtfarbe oder CRI-Wert ist einfach, rasch und mit vergleichsweise geringen Kosten umgesetzt.



Effizienzsteigerung und Kostenersparnis

Der weiterentwickelte MOVA Strahler mit X-Change Technology konnte durch den größeren Reflektor und dessen innovativer Beschichtung in seiner Effizienz auf beachtliche 97% gesteigert werden. Die durch das neue System erzielte Flexibilität und Anpassungsmöglichkeit im Laufe der Lebenszeit des Strahlers bedeutet zudem einen massiven Einsparungseffekt, denn der Tausch der COB liegt bei rund 10% der Initialkosten, die ein Austausch eines kompletten Strahlers verursachen würde. Der Tausch amortisiert sich daher in wesentlich kürzerer Zeit.



Nachhaltigkeit und Ressourcenschonung

Weniger Materialverschwendung und Müll sowie geringere Transportaufwände sind mit einem reinen COB-Tausch zusätzlich gesichert. Das schützt unsere Umwelt. Zudem bringen die erzielten Effizienzsteigerungen durch niedrigere Leistungsaufnahme bei gleichem Lichtstromoutput, eine positivere Umweltbilanz mit sich.



Dekorative Leuchten ein langlebiges Designobjekt

Durch den einfachen COB-Tausch wird es in der Zukunft sicher auch für dekorative Leuchten möglich sein, die hochwertigen Leuchtenkörper deutlich länger als bis zum Lebensdauerende der LED im Einsatz zu haben. Wie von den GU10- oder E27-Fassungen bekannt, wird bei neuen Leuchten dann einfach nur das LED-Leuchtmittel getauscht. Geringe Kosten, umweltfreundliches Verhalten.

A number of advantages are associated with the replaceable LED. Of course, one thinks primarily of replacing defective LEDs at the end of their service life, but this is of rather secondary importance given the long cycles.

Easier generation change

Manufacturers of COBs bring a new generation of PCBs onto the market every 2-3 years on average. This is associated with significant increases in efficiency, as less power is consumed with more lumen output at the same time. The Molto Luce X-Change Technology makes it possible to quickly switch to new COB generations and to benefit from this in terms of effect and costs.

Uncomplicated adaptation to changing requirements

Thanks to the Molto Luce X-Change technology, the spotlights can be adapted to changing lighting tasks without tools. The COB module or the reflector can be changed in a few simple steps. A different light colour or CRI value can be implemented easily, quickly and at a comparatively low cost.

Increased efficiency and cost savings

The efficiency of the further developed MOVA spotlight with X-Change Technology has been increased to a remarkable 97% thanks to the larger reflector and its innovative coating. The flexibility and adaptability achieved by the new system in the course of the spotlight's lifetime also mean a massive savings effect, because replacing the COB is around 10% of the initial costs that would be incurred by replacing a complete spotlight. The replacement, therefore, pays for itself in a much shorter time.

Sustainability and resource conservation

Less material wastage and waste as well as lower transport costs are additionally ensured with a pure COB exchange. This protects our environment. In addition, the efficiency increases achieved through lower power consumption with the same luminous flux output result in a more positive environmental balance.

Decorative luminaires a durable design object

Thanks to simple COB replacement, it will certainly also be possible in the future for decorative luminaires to have the high-quality luminaire bodies in use significantly longer than until the end of the LED's service life. As known from GU10 or E27 sockets, only the LED light source is replaced in new luminaires. Low costs, environmentally friendly behaviour.

AREAS OF APPLICATION

Die Weiterentwicklung des, primär im Retail-Sektor eingesetzten, Strahlers, bietet nun eine funktionale Lösung, um Anpassungen rasch und mit möglichst geringen Kosten vornehmen zu können. Der Wechsel der COB erfolgt mit Hilfe eines Bajonette-Verschlusses komplett werkzeuglos und kann auch direkt an der Stromschiene vorgenommen werden. Das COB-Modul gibt es einerseits mit einem Schutzglas für wirkungsvollen Staubschutz, aber auch ohne Glas als hoch-effiziente Lösung.

The further development of the spotlight, which is primarily used in the retail sector, now offers a functional solution to enable adjustments to be made quickly and at the lowest possible cost. The COB can be changed completely without tools using a bayonet lock and can also be carried out directly on the power rail. The COB module is available with protective glass for effective dust protection, but also without glass as a highly efficient solution.



Info & Video X-CHANGE



Configure MOVA X-CHANGE



X-CHANGE



Ducati Flagship Store
Ingolstadt, Germany
Photo: Joachim Rauch

Wimberger Haus
Lasberg, Austria
Planing & Realisation: Ben Elmecker
Photo: Joachim Rauch

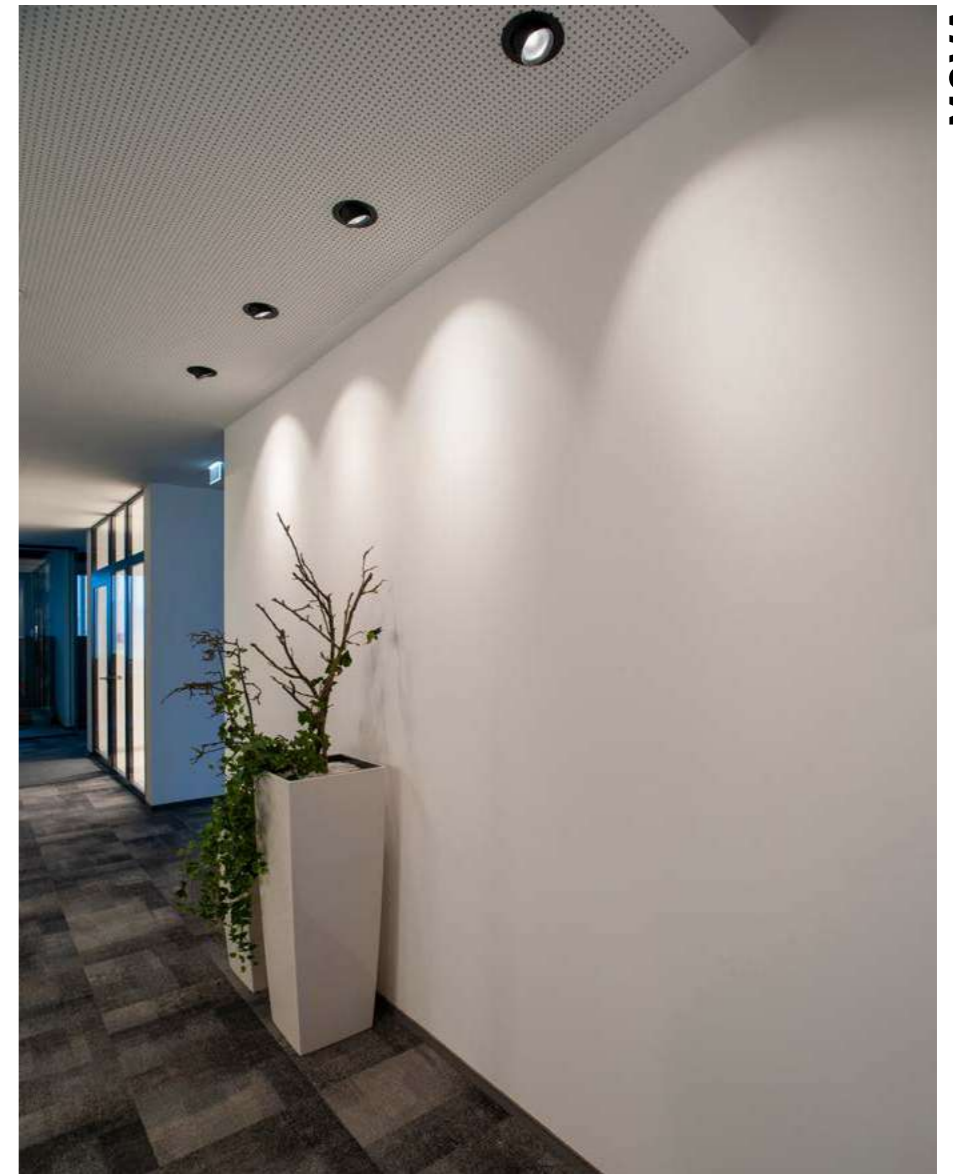

Optik Tieber
Schladming, Austria
Photo: Joachim Rauch



TIENDA OFICIAL GRANADA C.F. Estadio
Granada, Spain
Photo: Juanan Barros





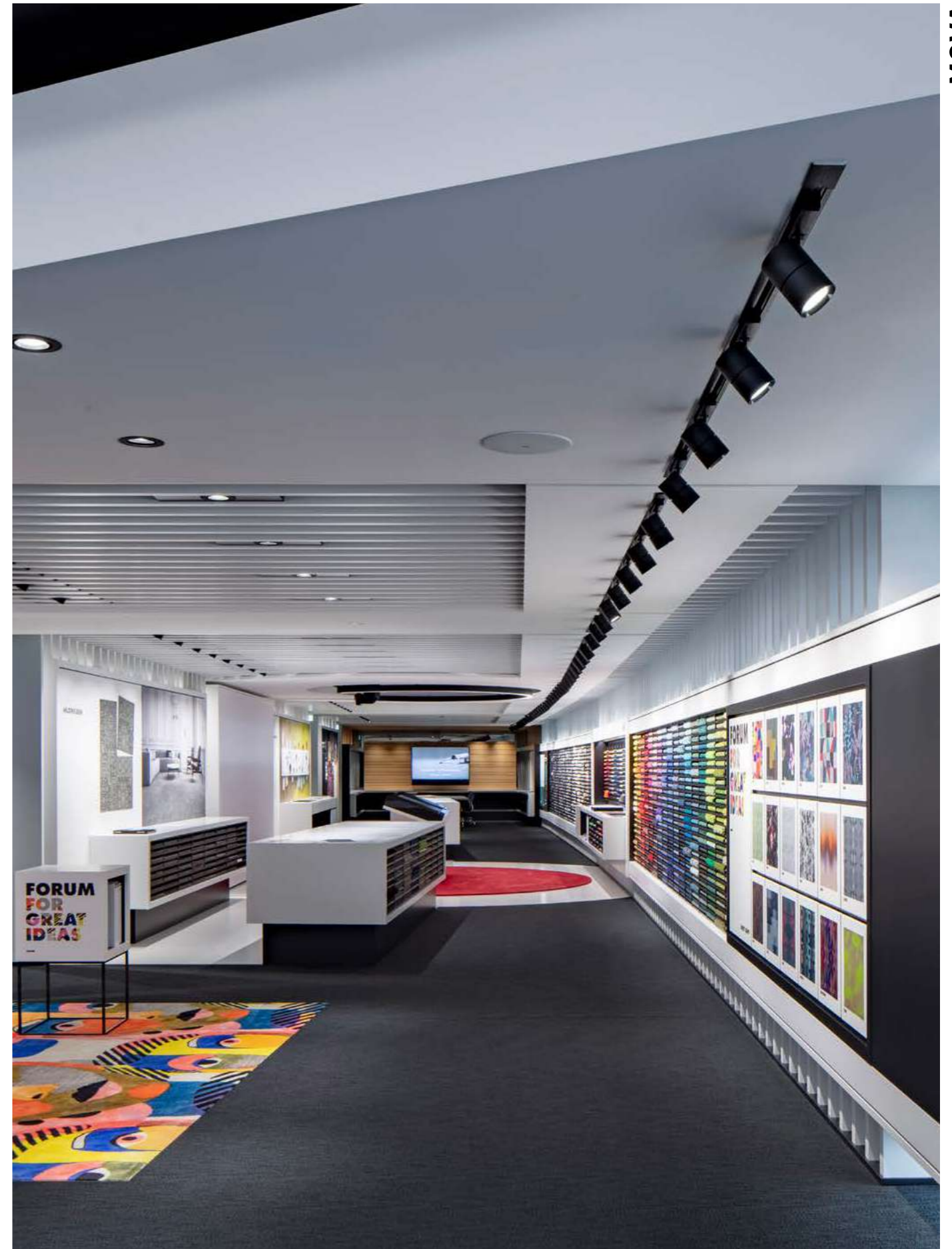



Mercedes Showroom
Dubai, VAE
Photo: yasserphotography.com



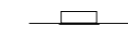

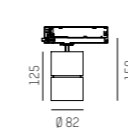
Object Carpet GmbH / City of Visions
Denkendorf, Germany
Photo: Markus Guhl

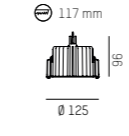
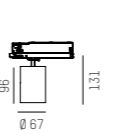
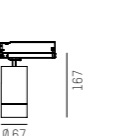

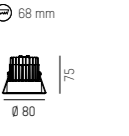
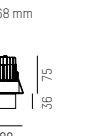











Versions

										
recessed	track									
										
MOVA M track 14 - 40W 680 - 4650lm	MOVA M TURN recessed 12 - 35W 680 - 4650lm	MOVA M recessed 12 - 35W 680 - 4650lm	MOVA S track 8 - 20W 390 - 2130lm	MOVA S L track 8 - 20W 190 - 1640lm	MOVA S TURN recessed 8 - 20W 390 - 2130lm	MOVA S L TURN recessed 8 - 20W 190 - 1640lm	MOVA S recessed 8 - 20W 390 - 2130lm	MOVA S L recessed 8 - 20W 190 - 1640lm		

Core Colours

		
white	black	grey

Creative Colours

					
copper	berlin blue	gold	berry blue	merlot	terra
					
highland green	creme	sepia	anthrazit	forest	bronze

Optics

				
basic reflector	high efficiency reflector	asymmetric reflector	dark reflector	lens

Accessoires

			
protector glass	spread lens	softener lens	honeycomb

LED Colour

									
2700K	3000K	3500K	4000K	RED MEAT	MARBLE MEAT	FISH	BREAD	MAGIC COLOUR	MAGIC WHITE

Specials

		
dim2spot	dim2warm	

Design: INHOUSE

Configurate MOVA





MOVA S GU10 TRACK

220-240V AC 50/60Hz QPAR 16 / GU10 / Retrofit max. 9W

Design: INHOUSE

LED Schienenstrahler aus Aluminiumdruckguss · Feinstrukturlack · passend für LED Retrofit QPAR 16 · exkl. Leuchtmittel.

LED track spotlight made of die-cast aluminium · fine textured paint · suitable for LED retrofit QPAR 16 · without lamps.

Proiettore LED in alluminio pressofuso · verniciatura · compatibile con lampadine LED retrofit QPAR16 · lampadine escluse.

Projecteur LED en aluminium moulé sous pression · peinture · compatible avec les ampoules LED QPAR16 retrofit · sans ampoules.

MOVA S GU10 TRACK

495-72000000XX0

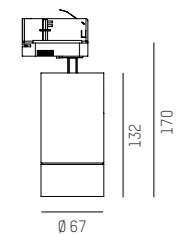

LEUCHTMITTEL 6,2W CRI>90

BULB 6,2W CRI>90

30-675414

30-705251

LICHTFARBE

COLOUR

2700K / 575lm

3000K / 575lm



IP20

COMPLETE CODE FOR ADAPTER

X = COLOUR

grey = 44

white = 55

black = 66

276

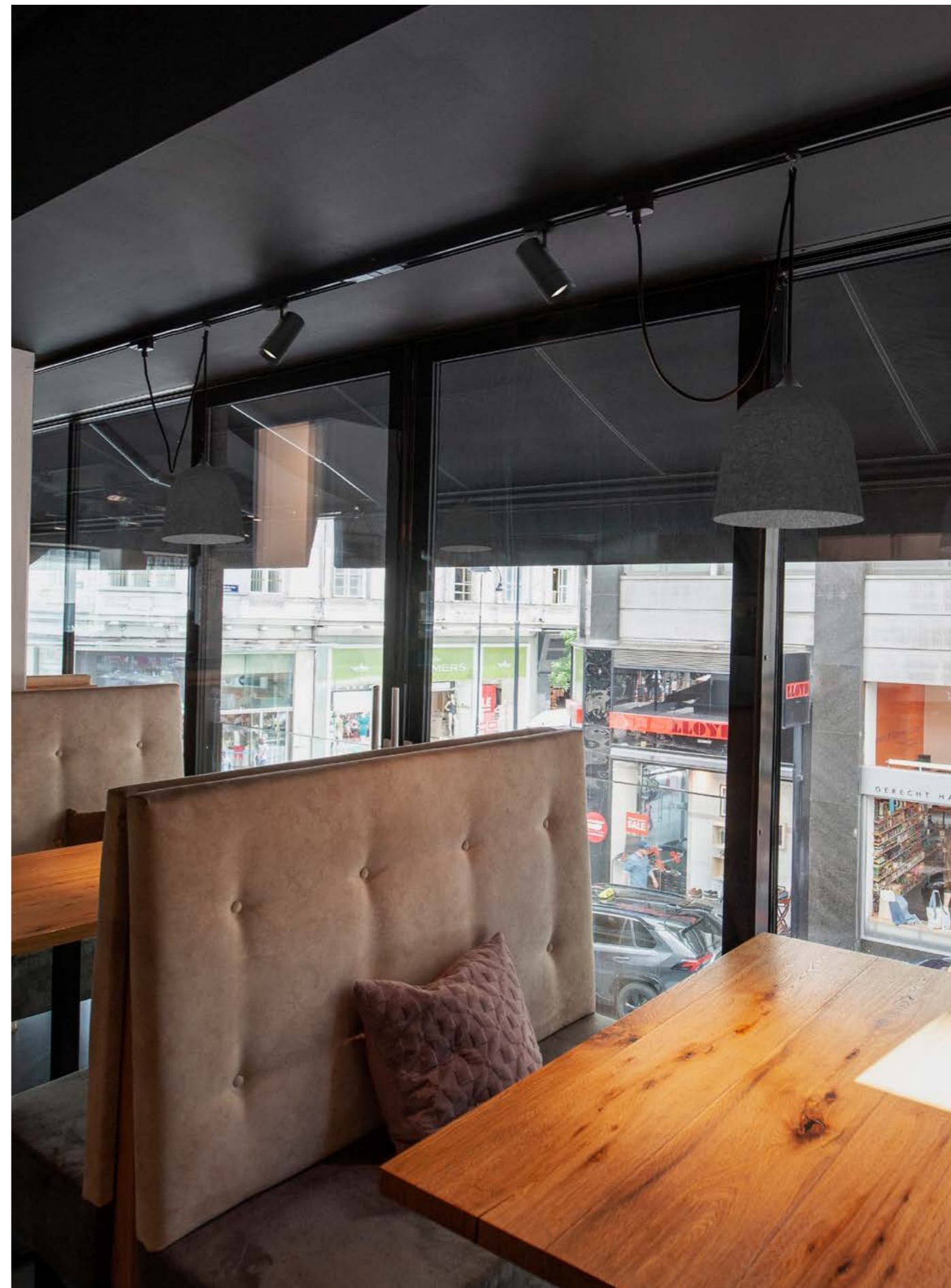

MOVA S GU10 TRACK

Technical data and energy efficiency



MOVA S GU10 TRACK

Restaurant Le Burger
Vienna, Austria
Photo: Joachim Rauch

277

BACK TO CONTENT



PERFECT LIGHTING TECHNOLOGY FOR RETAIL

ARTIS ist als 3-Phasen Stromschienenstrahler oder Einbaustrahler in 1-flammig asymmetrisch und 2-flammig doppelasymmetrisch sowie als Gondelkopfversion erhältlich. Der eigens konstruierte Freiformflächenreflektor mit Facettierung kombiniert maximale Effizienz mit bestmöglicher Längsentblendung bei einer absolut homogenen Ausleuchtung der zur beleuchtenden Fläche. Zudem kann Artis auch in den Sonderlichtfarben Magic Colour, Magic White, Meat & Fish, Fruits & Vegetables, Bread sowie 3500K Premium CRI>90 bestellt werden. Artis Matrix bietet eine absolute Innovation, welche erstmals das Anpassen der Abstrahlcharakteristik Vorort möglich macht. Für mehr Licht am Boden stellen sie einfach am Strahler die benötigte Helligkeit ein. Mit dem separat erhältlichen Light Guider verfügen Sie zudem über eine Bannerbeleuchtung in der dritten Ebene.

Artis is available as a 3-phase track spotlight or recessed spotlight with 1 light asymmetrical and with 2 lights double asymmetrical as well as single shelf version in black and white. The specially designed free-form surface reflector with faceting combines maximum efficiency with the best possible longitudinal glare control for absolutely homogeneous lighting of the surface to be illuminated. Artis can also be ordered in the special light colours Magic Colour, Magic White, Meat & Fish, Fruits & Vegetables, Bread and 3500K Premium CRI>90. Artis Matrix offers an absolute innovation, which for the first time makes it possible to adapt the beamangle on-site. If you would like more light on the floor just set the required brightness on the spotlight. With the separately available Light Guider banner on the 3rd level can also be illuminated.

Design: INHOUSE

ARTIS

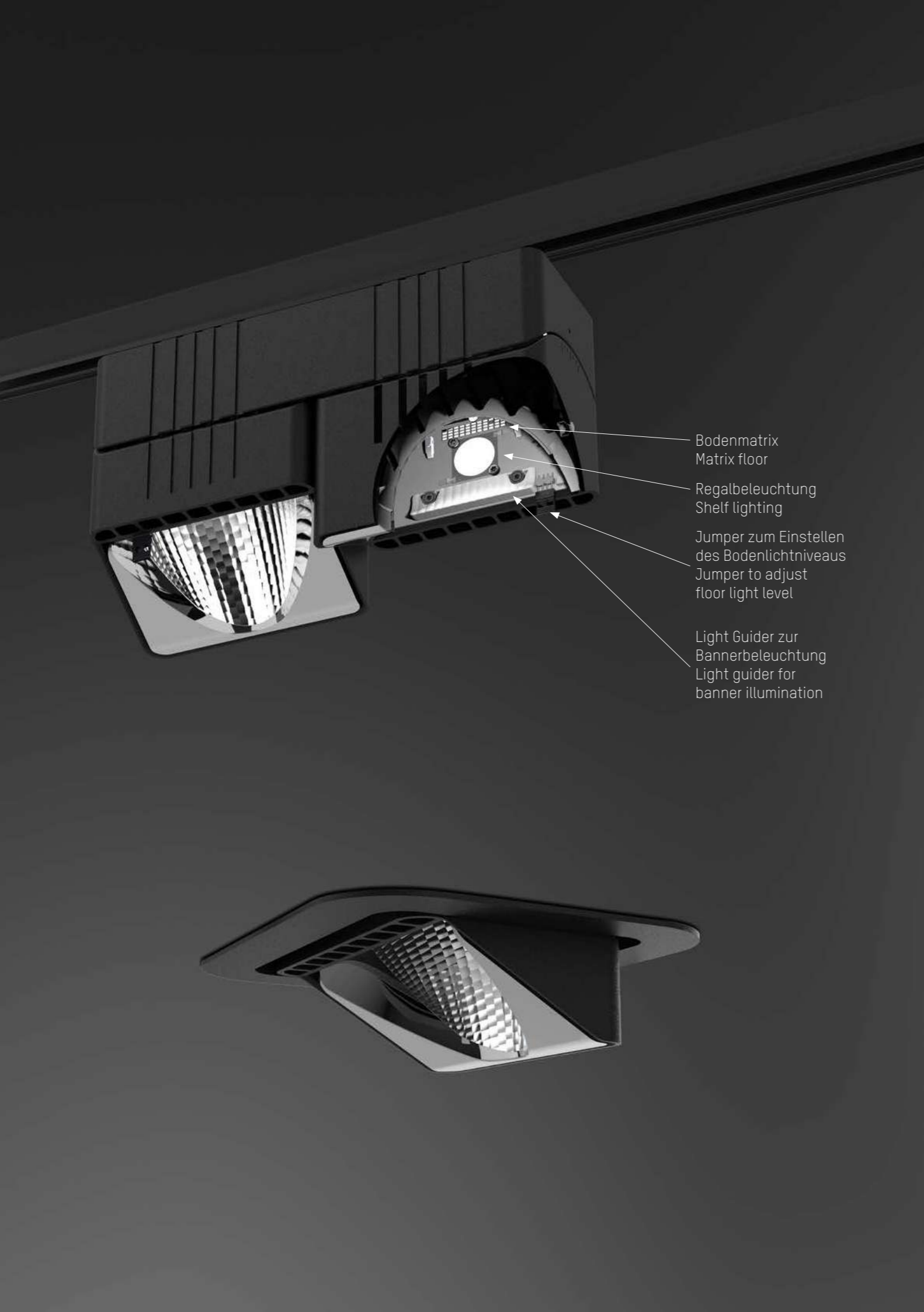

Versions



Core Colours



Light beam



LED Colour



Specials

Artis Matrix - Der erste Strahler bei dem das Lichtbild Vorort elektronisch beeinflusst und adaptiert werden kann. Selbst nach der Montage kann die Abstrahlcharakteristik auf einfachste Weise direkt am Strahler angepasst werden.

Artis Matrix - The first spotlight in which the light pattern can be electronically influenced and adapted on site. Even after mounting, the radiation characteristics can be easily adjusted directly on the spotlight.

Artis Shelf Strahler wird im Shop verwendet, um Produkte in Stirnseiten von Regalen perfekt in Szene zu setzen.

Artis Shelf spotlights are used in shops to show perfectly products in the front of shelves.

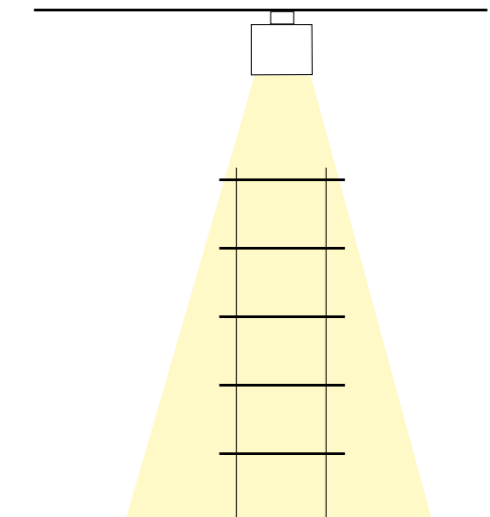
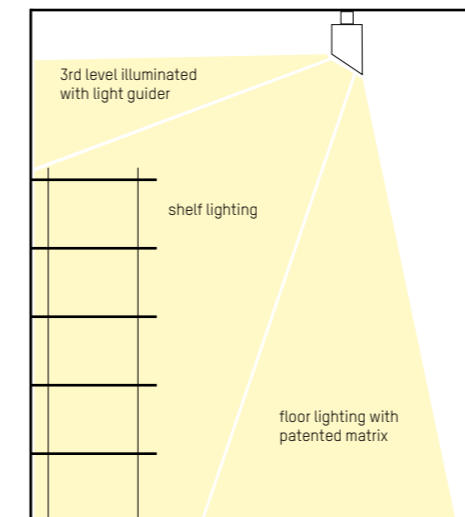

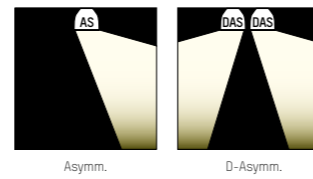

ARTIS TRACK

220-240V AC 50/60Hz Design: INHOUSE



Stromschienenstrahler mit Wallwasheroptik · Oberfläche Feinstrukturlack · vakuumbedampfter +/- 15° schwenkbarer Reflektor
 Track spotlight with wallwasher optics · surface microstructure painting · vacuum deposited reflector +/- 15° swiveling
 Proiettore da binario con ottica wallwasher · superficie verniciata a struttura fine · riflettore purissimo sottovuoto +/- 15° orientabile
 Projecteur pour rail avec optique wallwasher · surface fine texture peinte · réflecteur à vide pur +/- 15° réglable

ARTIS 1 TRACK

SYS 40W	LM
704-1110101WWXXY	3690 - 4390

Asymmetrischer Lichtaustritt
 Asymmetric light beam

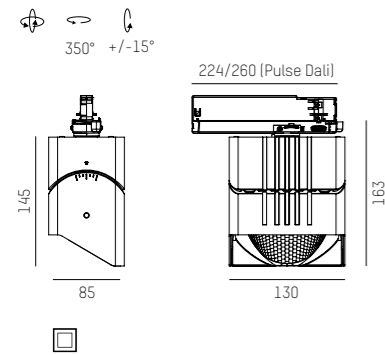

ARTIS 2 TRACK

SYS 80W	LM
704-1120102WWXXY	7380 - 8780

Doppelasymmetrischer Lichtaustritt
 Double asymmetric light beam

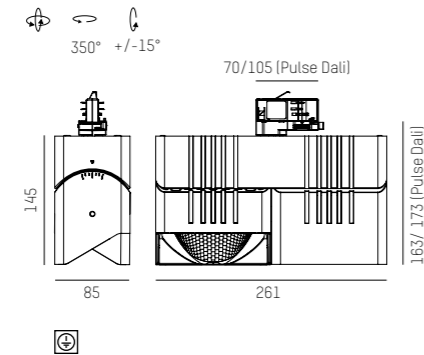

LIGHT GUIDER

704-9000310

Zusätzlicher Reflektor zur Bannerbeleuchtung
 in der 3. Ebene
 Additional reflector to illuminate banners
 in the 3rd level

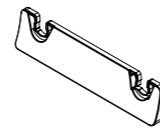

IP20 CE

COMPLETE CODE		
WW = LIGHT COLOUR	XX = COLOUR	Y = DIMMABLE
W2 LED 2700K = 43 PREMIUM CRI>90	W white = 05	S switchable = 0
W3 LED 3000K = 49 PREMIUM CRI>90	S black = 06	P PULSE DALI dimm. = p
W4 LED 4000K = 24 CRI>90		B SMART BLUETOOTH = b

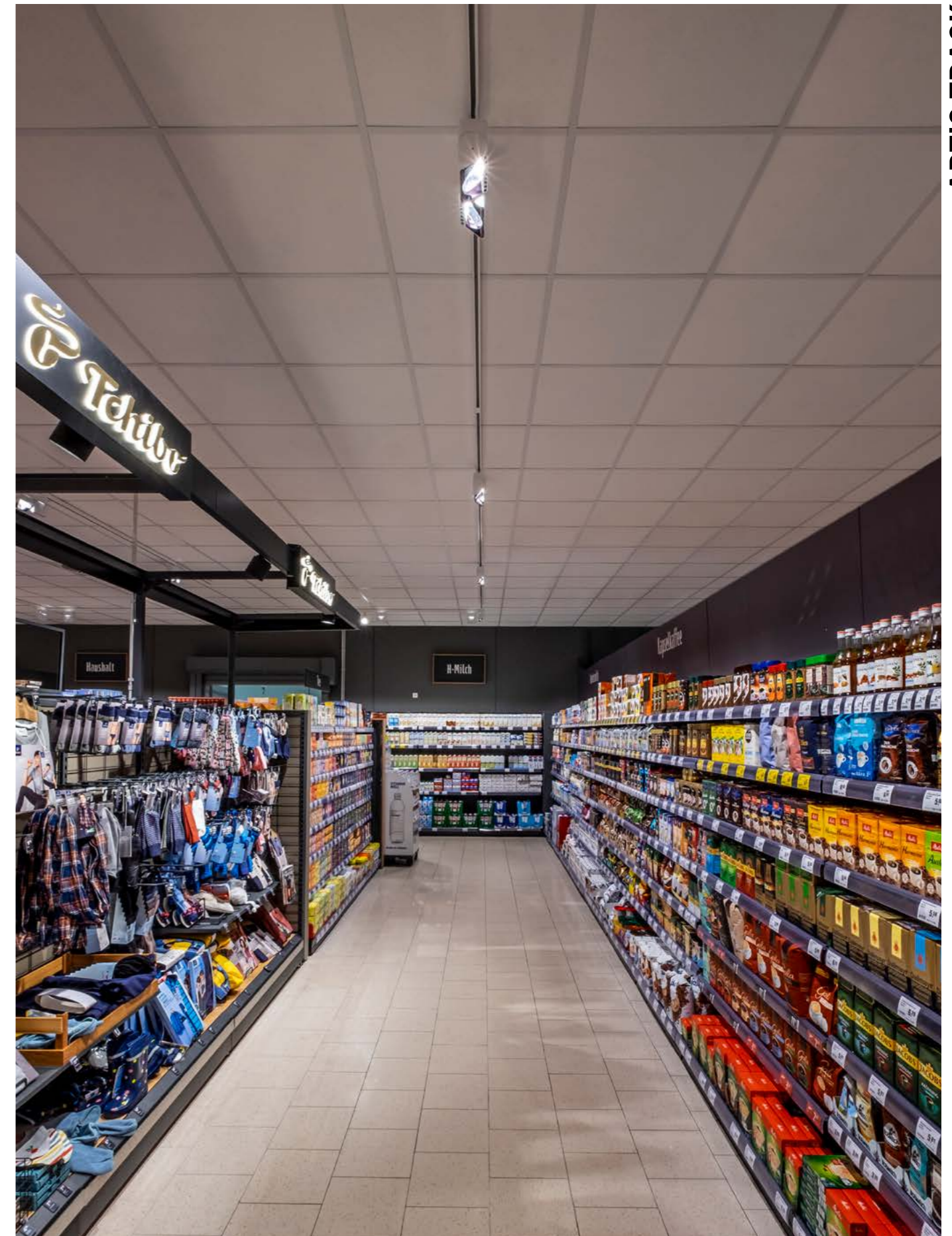

ARTIS TRACK

REWE
 Troisdorf/Bergheim, Germany
 Photo: Alexander Schwarz

Technical data and energy efficiency



ARTIS 1 TRACK



ARTIS 2 TRACK

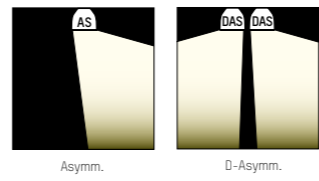

ARTIS MATRIX FLOOR TRACK

220-240V AC 50/60Hz Design: INHOUSE

Stromschienenstrahler mit Wallwasheroptik · Oberfläche Feinstrukturlack · vakuumbedampfter +/- 15° schwenkbarer Reflektor
 Track spotlight with wallwasher optics · surface microstructure painting · vacuum deposited reflector +/- 15° swiveling
 Proiettore da binario con ottica wallwasher · superficie verniciata a struttura fine · riflettore purissimo sottovuoto +/- 15° orientabile
 Projecteur pour rail avec optique wallwasher · surface fine texture peinte · réflecteur à vide pur +/- 15° réglable



ARTIS 1 MATRIX FLOOR TRACK

SYS 40W	LM
704-1110301WWXXY	3690 - 4390
Asymmetrischer Lichtaustritt Asymmetric light beam	

ARTIS 2 MATRIX FLOOR TRACK

SYS 80W	LM
704-1120302WWXXY	7380 - 8780
Doppelasymmetrischer Lichtaustritt Double asymmetric light beam	

LIGHT GUIDER

704-9000310
 Zusätzlicher Reflektor zur Bannerbeleuchtung in der 3. Ebene
 Additional reflector to illuminate banners in the 3rd level

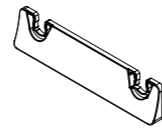
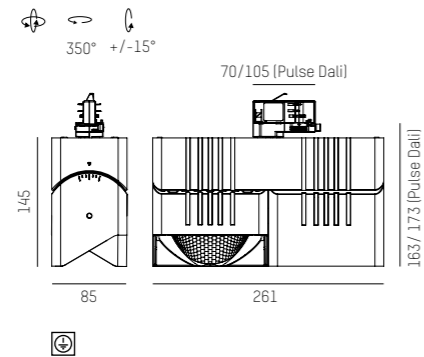
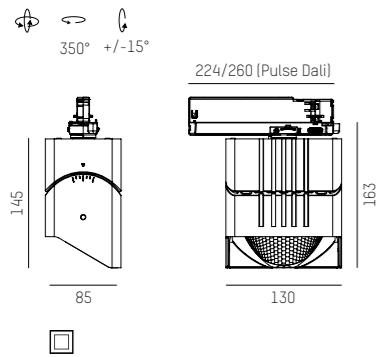

Technical data and energy efficiency



ARTIS 1 MATRIX FLOOR TRACK



ARTIS 2 MATRIX FLOOR TRACK

IP20 CE

COMPLETE CODE		
WW = LIGHT COLOUR	XX = COLOUR	Y = DIMMABLE
W2 LED 2700K = 43 PREMIUM CRI>90	W white = 05	S switchable = 0
W3 LED 3000K = 49 PREMIUM CRI>90	S black = 06	P PULSE DALI dimm. = p
W4 LED 4000K = 24 CRI>90		B SMART BLUETOOTH = b

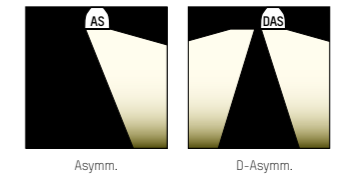

To luminaire the head of the shelf ARTIS Single Shelf

ARTIS SINGLE SHELF TRACK

220-240V AC 50/60Hz Design: INHOUSE

Stromschienenstrahler mit Wallwasheroptik · Oberfläche Feinstrukturlack · vakuumbedampfter +/- 15° schwenkbarer Reflektor dimmbar
 Track spotlight with wallwasher optics · fine structure powder-coated in white or black · vacuum deposited reflector +/- 15° swiveling
 Proiettore da binario con ottica wallwasher · finitura in bianco o nero · riflettore purissimo sottovuoto +/- 15° orientabile · on/off oppure dimmerabile DALI
 Projecteur pour rail avec optique wallwasher · finition noire ou blanche · réflecteur à vide pur +/- 15° réglable · on/off ou DALI dimmable



ARTIS 1 SINGLE SHELF TRACK

SYS 40W	LM
704-1111101WWXXY	3370 - 4020
Asymmetrischer Lichtaustritt Asymmetric light beam	

ARTIS 2 SINGLE SHELF TRACK

SYS 80W	LM
704-1121102WWXXY	6750 - 8040
Doppelasymmetrischer Lichtaustritt Double asymmetric light beam	

LIGHT GUIDER

704-9000310
 Zusätzlicher Reflektor zur Bannerbeleuchtung in der 3. Ebene
 Additional reflector to illuminate banners in the 3rd level

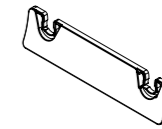
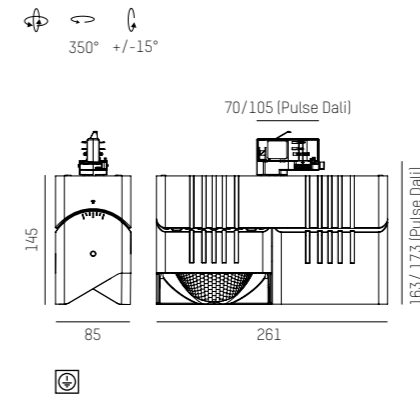
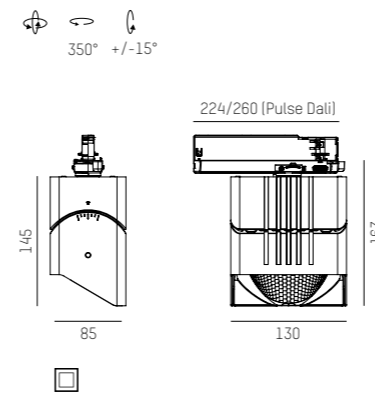

Technical data and energy efficiency



ARTIS 1 SINGLE SHELF TRACK



ARTIS 2 SINGLE SHELF TRACK

IP20 CE

COMPLETE CODE		
WW = LIGHT COLOUR	XX = COLOUR	Y = DIMMABLE
W2 LED 2700K = 43 PREMIUM CRI>90	W white = 05	S switchable = 0
W3 LED 3000K = 49 PREMIUM CRI>90	S black = 06	P PULSE DALI dimm. = p
W4 LED 4000K = 24 CRI>90		B SMART BLUETOOTH = b

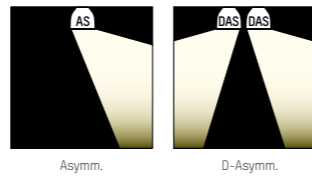

ARTIS R

220-240V AC 50/60Hz Design: INHOUSE



Einbastrahler mit Wallwasheroptik · Oberfläche Feinstrukturlack · vakuumbedampfter +/- 15° schwenkbarer Reflektor
 Recessed spotlight with wallwasher optics · surface microstructure painting · vacuum deposited reflector +/- 15° swiveling
 Incasso con ottica wallwasher · superficie verniciata a struttura fine · riflettore purissimo sottovuoto +/- 15° orientabile
 Spot encastré avec optique wallwasher · surface fine texture peinte · réflecteur à vide pur +/- 15° réglable

ARTIS 1 R

LED 40W 1050mA LM
 704-2110101WWXXY 3690 - 4390

Asymmetrischer Lichtaustritt
 Asymmetric light beam

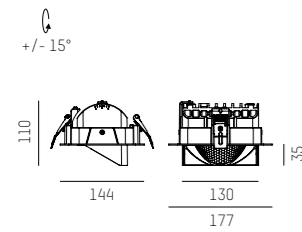

133 x 145mm
 100mm
 1 - 25mm

LED CONVERTER	DIMM
24-127484	driver switchable
24-127490	driver Dali dimm.
701-1001	driver BLUETOOTH dimm.

ARTIS 2 R

LED 80W 2x 1050mA LM
 704-2120102WWXXY 7380 - 8780

Doppelasymmetrischer Lichtaustritt
 Double asymmetric light beam

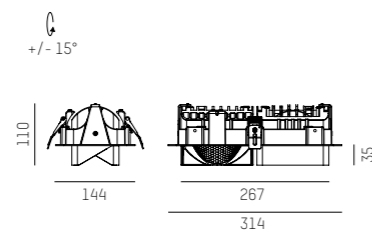

133 x 280mm
 100mm
 1 - 25mm

LED CONVERTER	DIMM
2x 24-127484	driver switchable
2x 24-127490	driver Dali dimm.
2x 701-1001	driver BLUETOOTH dimm.

LIGHT GUIDER

704-9000310

Zusätzlicher Reflektor zur Bannerbeleuchtung
 in der 3. Ebene
 Additional reflector to illuminate banners
 in the 3rd level

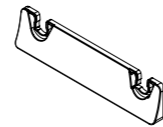

IP20 CE

COMPLETE CODE	
WW = LIGHT COLOUR	XX = COLOUR
W2 LED 2700K = 43 PREMIUM CRI>90	W white = 05
W3 LED 3000K = 49 PREMIUM CRI>90	S black = 06
W4 LED 4000K = 24 CRI>90	

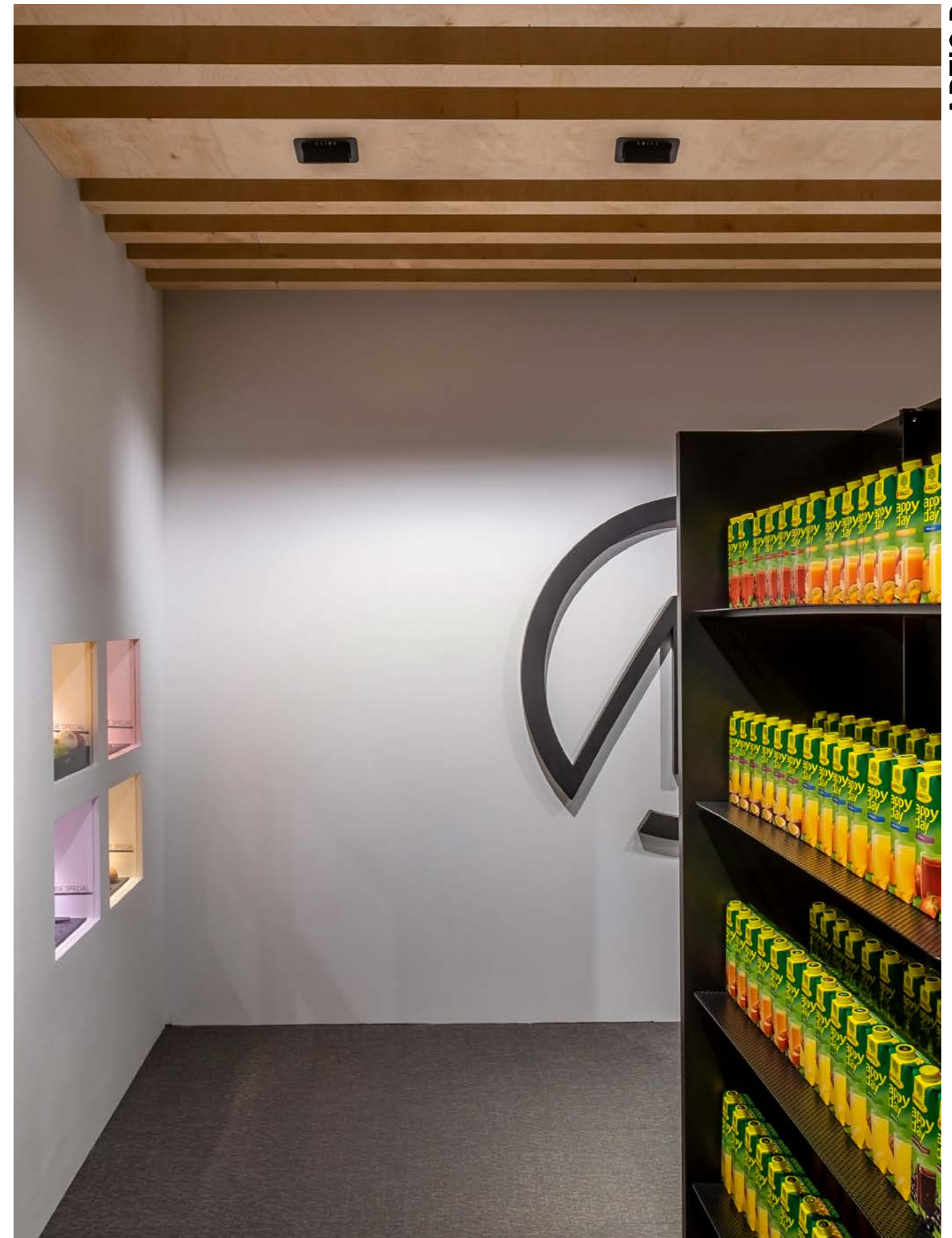

ARTIS R

Molto Luce Fair Stand
 Düsseldorf, Germany

Technical data and energy efficiency



ARTIS 1 R



ARTIS 2 R

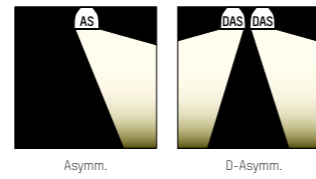

ARTIS R

220-240V AC 50/60Hz Design: INHOUSE

Einbaustrahler mit Wallwasheroptik · Oberfläche Feinstrukturlack · vakuumbedampfter +/- 15° schwenkbarer Reflektor
 Recessed spotlight with wallwasher optics · surface microstructure painting · vacuum deposited reflector +/- 15° swiveling
 Incasso con ottica wallwasher · superficie verniciata a struttura fine · riflettore purissimo sottovuoto +/- 15° orientabile
 Spot encastré avec optique wallwasher · surface fine texture peinte · réflecteur à vide pur +/- 15° réglable



ARTIS 1 MATRIX FLOOR R

LED 40W 1050mA	LM
704-2110301WWXXY	3690 - 4390

Asymmetrischer Lichtaustritt
 Asymmetric light beam

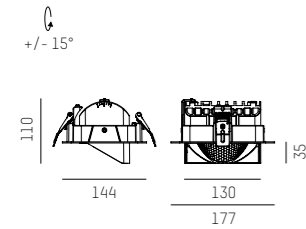

- 133 x 145mm
- 100mm
- 1 - 25mm

ARTIS 2 MATRIX FLOOR R

LED 80W 2x 1050mA	LM
704-2120302WWXXY	7380 - 8780

Doppelasymmetrischer Lichtaustritt
 Double asymmetric light beam

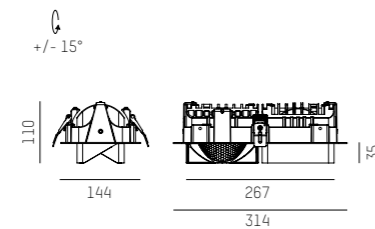

- 133 x 280mm
- 100mm
- 1 - 25mm

LED CONVERTER	DIMM
24-127484	driver switchable
24-127490	driver Dali dimm.
701-1001	driver BLUETOOTH dimm.

LED CONVERTER	DIMM
2x 24-127484	driver switchable
2x 24-127490	driver Dali dimm.
2x 701-1001	driver BLUETOOTH dimm.

LIGHT GUIDER

704-9000310
 Zusätzlicher Reflektor zur Bannerbeleuchtung in der 3. Ebene
 Additional reflector to illuminate banners in the 3rd level

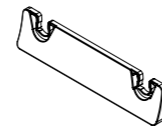

Technical data and energy efficiency



ARTIS 1 MATRIX FLOOR R



ARTIS 2 MATRIX FLOOR R

IP20

COMPLETE CODE	
WW = LIGHT COLOUR	XX = COLOUR
W2 LED 2700K = 43 PREMIUM CRI>90	W white = 05
W3 LED 3000K = 49 PREMIUM CRI>90	S black = 06
W4 LED 4000K = 24 CRI>90	

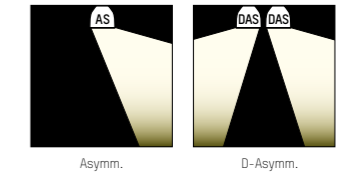

ARTIS SINGLE SHELF R

220-240V AC 50/60Hz Design: INHOUSE

Einbaustrahler mit Wallwasheroptik · Oberfläche Feinstrukturlack · vakuumbedampfter +/- 15° schwenkbarer Reflektor
 Recessed spotlight with wallwasher optics · surface microstructure painting · vacuum deposited reflector +/- 15° swiveling
 Incasso con ottica wallwasher · superficie verniciata a struttura fine · riflettore purissimo sottovuoto +/- 15° orientabile
 Spot encastré avec optique wallwasher · surface fine texture peinte · réflecteur à vide pur +/- 15° réglable

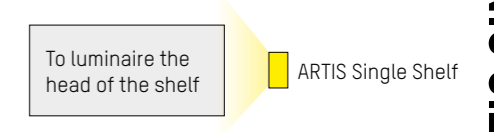

ARTIS 1 SINGLE SHELF R

LED 40W 1050mA	LM
704-2111101WWXXY	3370 - 4020

Asymmetrischer Lichtaustritt
 Asymmetric light beam

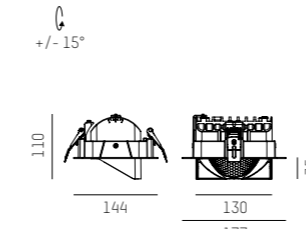

- 133 x 145mm
- 100mm
- 1 - 25mm

ARTIS 2 SINGLE SHELF R

LED 80W 2x 1050mA	LM
704-2121102WWXXY	6750 - 8040

Doppelasymmetrischer Lichtaustritt
 Double asymmetric light beam

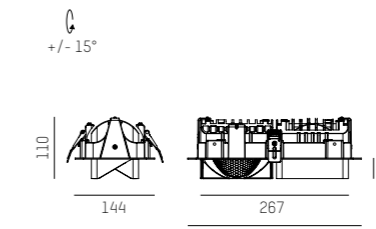

- 133 x 280mm
- 100mm
- 1 - 25mm

LED CONVERTER	DIMM
24-127484	driver switchable
24-127490	driver Dali dimm.
701-1001	driver BLUETOOTH dimm.

LED CONVERTER	DIMM
2x 24-127484	driver switchable
2x 24-127490	driver Dali dimm.
2x 701-1001	driver BLUETOOTH dimm.

LIGHT GUIDER

704-9000310
 Zusätzlicher Reflektor zur Bannerbeleuchtung in der 3. Ebene
 Additional reflector to illuminate banners in the 3rd level

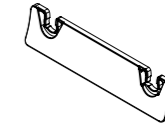

Technical data and energy efficiency



ARTIS 1 SINGLE SHELF R



ARTIS 2 SINGLE SHELF R

IP20

COMPLETE CODE	
WW = LIGHT COLOUR	XX = COLOUR
W2 LED 2700K = 43 PREMIUM CRI>90	W white = 05
W3 LED 3000K = 49 PREMIUM CRI>90	S black = 06
W4 LED 4000K = 24 CRI>90	

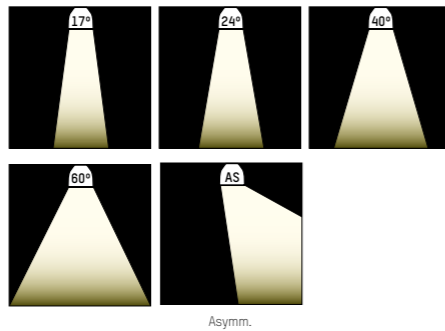

Asymm.

2 GO+ TRACK

220-240V AC 50/60Hz Design: INHOUSE

BLUETOOTH  

LED Strahler aus Aluminiumdruckguss · Oberfläche pulverbeschichtet · Konverter im Strahlerkopf · steuerbar über Molto Luce Smart APP
 Die cast aluminium LED track spotlight · surface powder-coated · integrated Bluetooth LED Driver · controllable with Molto Luce Smart APP
 Faretto in alluminio pressofuso per binario · superficie verniciata a polveri · Bluetooth LED driver integrato · controllabile con Molto Luce Smart APP
 Spot sur rail en aluminium · surface thermolaquée · pilotage de LED par Bluetooth intégré · contrôlable avec système Molto Luce Smart APP

SYS 27W	LM
637-00402RRWWXXbv1	2380 - 2900







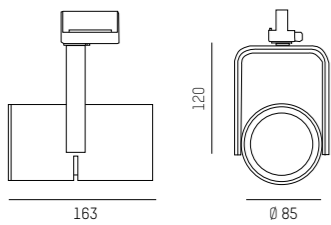



BLUETOOTH GATEWAY

701-0001

zusätzlich zur APP erforderlich bei zeitgesteuerten Abläufen
 in addition to the app required for timed operations



IP20 

COMPLETE CODE		
RR = BEAM ANGLE	WW = LIGHT COLOUR	XX = COLOUR
 spot 17° = 01	 LED 2700K = 43 PREMIUM CRI>90	 grey = 04
 medium 24° = 02	 LED 3000K = 49 PREMIUM CRI>90	 white = 05
 flood 40° = 03	 LED 4000K = 24 CRI>90	 black = 06
 wide flood 60° = 04		
 asymmetric = 05		



2 GO+ TRACK

Technical data and energy efficiency



2 GO TRACK

Kulturgarage
 Vienna, Austria
 Photo: Joachim Rauch

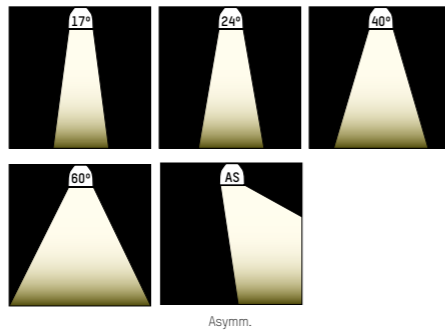

Asymm.

2 GO TRACK

220-240V AC 50/60Hz Design: INHOUSE



LED Strahler aus Aluminiumdruckguss · Oberfläche pulverbeschichtet · Converter im Strahlerkopf DALI dimmbar oder schaltbar
 Die cast aluminium LED track spotlight · surface powder-coated · Integrated Dali dimmable or switchable
 Faretto in alluminio pressofuso per binario · superficie verniciata a polveri · converter on-off o dimmerabile DALI inclusoorizzontale
 Spot sur rail en aluminium · surface thermolaquée · convertiseur on-off ou dimmable DALI inclusconvertiseur

2 GO TRACK

SYS 19W	LM
637-00101RRWWXX0v1	1770 - 2190

2 GO TRACK

SYS 27W	LM
637-00102RRWWXXYv1	2350 - 2910

2 GO PRO TRACK

SYS 26W	LM
637-00103RRWWXX0v1	2700 - 3220

Mit 24° und 40° Reflektor verfügbar
 Available with 24° and 40° reflector

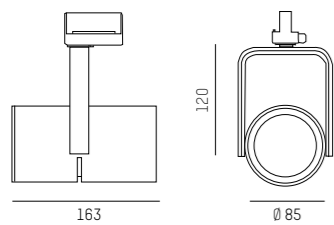

IP20 Ⓢ CE

COMPLETE CODE			
RR = BEAM ANGLE	WW = LIGHT COLOUR	XX = COLOUR	Y = DIMMABLE
spot 17° = 01	W2 LED 2700K = 43 PREMIUM CRI>90	g grey = 04	Ⓢ switchable = 0
medium 24° = 02	W3 LED 3000K = 49 PREMIUM CRI>90	w white = 05	Ⓟ PULSE DALI dimm = p
flood 40° = 03	W4 LED 4000K = 24 CRI>90	s black = 06	
wide flood 60° = 04			
asymmetric = 05			

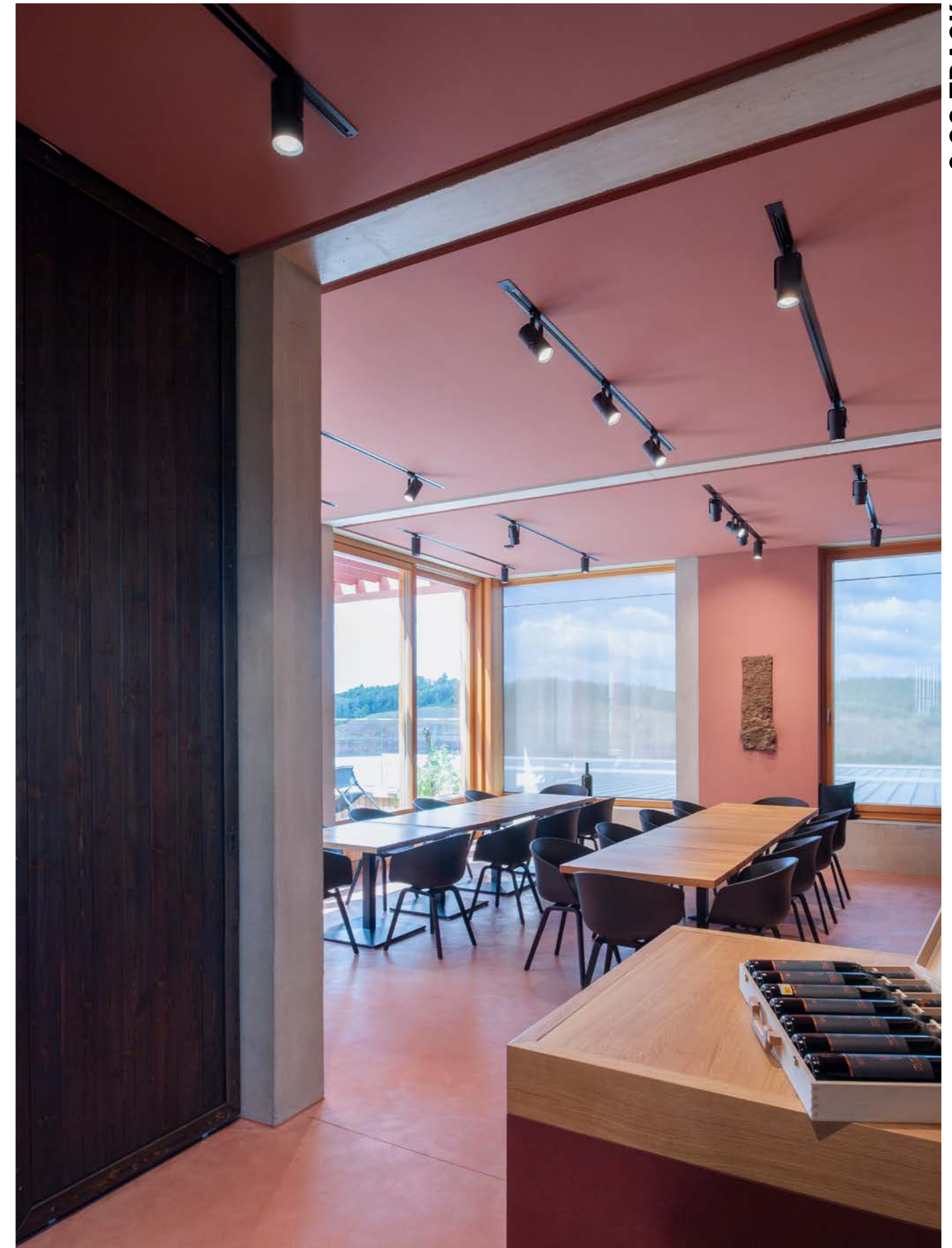

2 GO TRACK

Weingut Müller Vinothek
 Klöch, Austria
 Photo: Joachim Rauch

Technical data and energy efficiency



2 GO TRACK

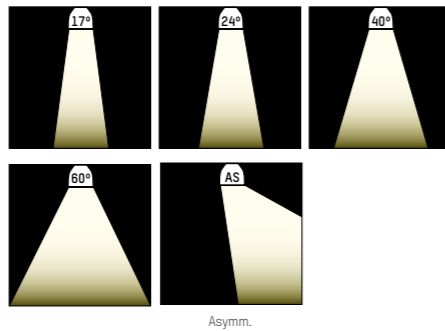

Asymm.

2 GO SD
220-240V AC 50/60Hz Design: INHOUSE



LED Aufbaustrahler aus Aluminiumdruckguss · Oberfläche pulverbeschichtet · Konverter im Strahlerkopf DALI dimmbar oder schaltbar
Die cast aluminium LED spotlight · surface powder-coated · Integrated Dali dimmable or switchable
Faretto in alluminio pressofuso · superficie verniciata a polveri · converter on-off o dimmerabile DALI inclusoorizzontale
Spot en aluminium · surface thermolaquée · convertiseur on-off ou dimmable DALI inclusconvertiseur

SYS 19W	LM	SYS 27W	LM
637-00501RRWWXX0v1	1770 - 2190	637-00502RRWWXXYv1	2350 - 2910

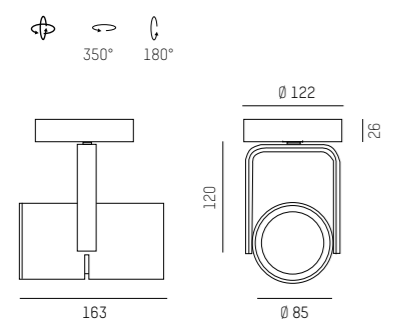

IP20 Ⓢ CE

COMPLETE CODE			
RR = BEAM ANGLE	WW = LIGHT COLOUR	XX = COLOUR	Y = DIMMABLE
☐ spot 17° = 01	W2 LED 2700K = 43 PREMIUM CRI>90	☐ grey = 04	☐ switchable = 0
☐ medium 24° = 02	W3 LED 3000K = 49 PREMIUM CRI>90	☐ white = 05	☐ DALI dimm = d
☐ flood 40° = 03	W4 LED 4000K = 24 CRI>90	☐ black = 06	
☐ wide flood 60° = 04			
☐ asymmetric = 05			

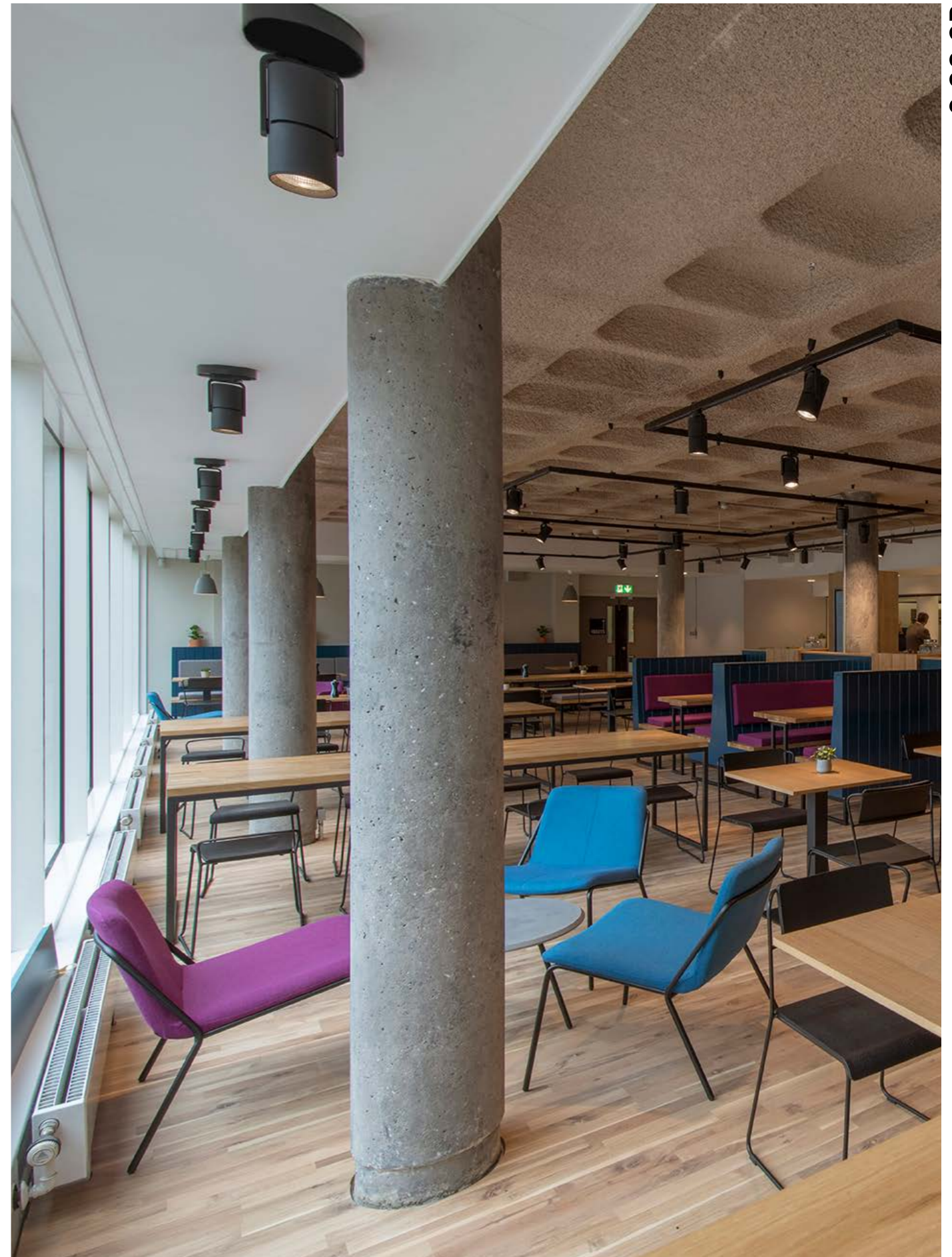

2 GO SD

The Cafe
Edinburgh, Scotland
Solus Solutions for lighting design
Project Architect: Lee Boyd

Technical data and energy efficiency



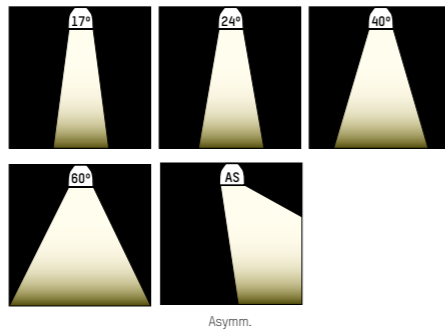

Asymm.

2 GO R

220-240V AC 50/60Hz Design: INHOUSE



LED Einbaustrahler · Oberfläche pulverbeschichtet · Strahler 350° drehbar, Leuchtenkopf 35° schwenkbar
 Die cast aluminium LED spotlight · surface powder-coated · 350° swiveling and 35° tilting head
 Incasso LED in alluminio · superficie verniciata a polveri · girevole a 350° e testa orientabile di 35°
 Encassé à LED en aluminium · surface thermolaquée · pivotant à 350 et inclinaison de 35°

LED 17W - 500mA	LM
LED 25W - 700mA	1770 - 2940
637-00201RRWWXXv1	

LED CONVERTER	mA	DIMM	FOR
24-127532n	500	schaltbar/switchable	2 GO R 17W
24-127534n	700	schaltbar/switchable	2 GO R 25W
24-127490	500-700	DALI dimm.	2 GO R 17/25W
701-1001	350 - 1200	SMART BLUETOOTH Dimm.	2 GO R 17/25W



350° 35°

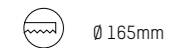
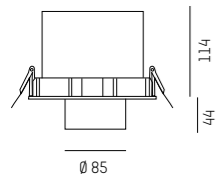

Ø 165mm

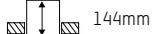

144mm

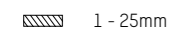

1 - 25mm

IP20

COMPLETE CODE		
RR = BEAM ANGLE	WW = LIGHT COLOUR	XX = COLOUR
spot 17° = 01	LED 2700K = 43 PREMIUM CRI>90	grey = 04
medium 24° = 02	LED 3000K = 49 PREMIUM CRI>90	white = 05
flood 40° = 03	LED 4000K = 24 CRI>90	black = 06
wide flood 60° = 04		
asymmetric = 05		

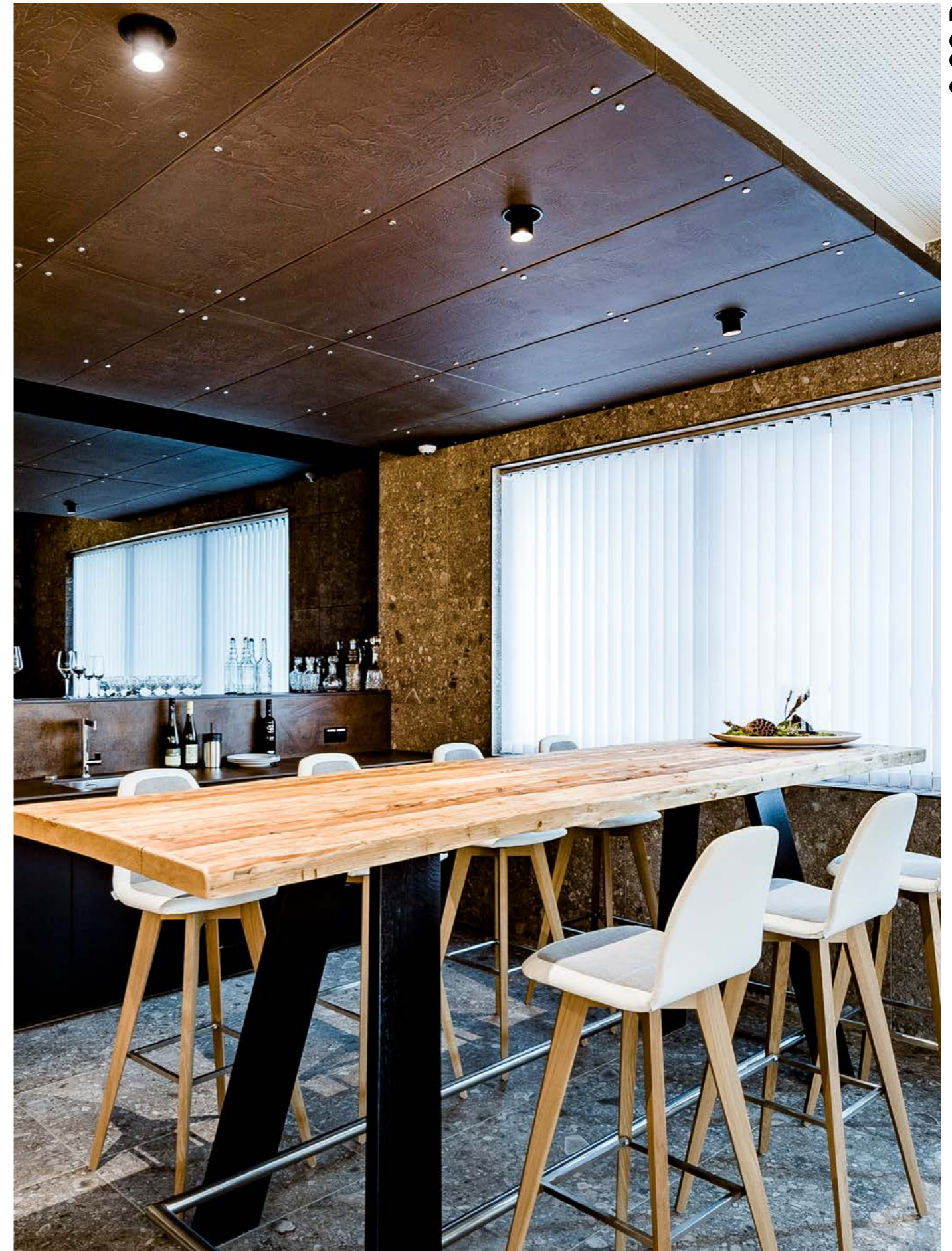

Technical data and energy efficiency

Kreisel & Electrics
 Rainbach, Austria
 Planning/realisation: Ben Elmecker
 Photo: Kreisel Electric / Martin Pröll



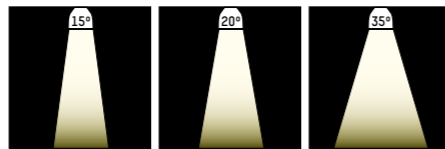

SHOPSTAR LEAN TRACK

220-240V AC 50/60Hz Design: INHOUSE



LED Stromschienenstrahler aus Aluminiumdruckguss · Oberfläche pulverbeschichtet · LED Konverter in 3-Phasen Adapter integriert
 Die cast aluminium LED track spotlight · surface microstructure painting · LED Driver integrated in 3 phase adapter
 Faretto in alluminio pressofuso per binario · superficie verniciata a struttura fine · converter LED integrato nell' adattatore trifase
 Spot sur rail en aluminium · surface fine texture peinte · convertisseur LED intégré dans adaptateur

SYS 27W	LM
608-00301CRWWXXYv1	2400 - 2810

SYS 34W	LM
608-00302CRWWXXYv1	2800 - 3280

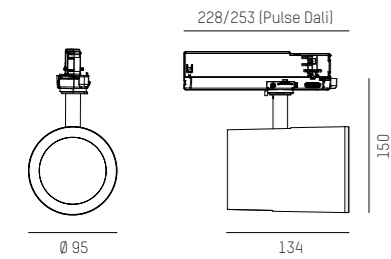

IP20



COMPLETE CODE	C = COVER	R = BEAM ANGLE	WW = LIGHT COLOUR	XX = COLOUR	Y = DIMMABLE
with glass = 0	spot 15° = 2	w2 LED 2700K = 43 PREMIUM CRI>90	g grey = 04	s switchable = 0	
without glass = 1	medium 20° = 5	w3 LED 3000K = 49 PREMIUM CRI>90	w white = 05	p PULSE DALI dimm = p	
	flood 35° = 8	w4 LED 4000K = 24 CRI>90	s black = 06		
	wide flood 60° = 9				



SHOPSTAR LEAN TRACK

IGLE Bookstore
 Amsterdam, Netherlands
 Project by Unique Brands
 Designer: M+R Interior Architecture
 Photo: Studio de Winter

Technical data and energy efficiency



SHOPSTAR LEAN TRACK



TRAIL TRACK

220-240V AC 50/60Hz UGR<19

Design: INHOUSE

3-Phasen Stromschienenleuchte · Oberfläche pulverbeschichtet · 4 verschiedene Abstrahlcharakteristiken · DALI oder Bluetooth dimmbar
 3-phase track luminaire · powder-coated surface · 4 different beam angels · DALI or Bluetooth dimmable
 Lampada da binario trifase · superficie verniciata a polveri · 4 diverse ottiche · dimmerabile Bluetooth o DALI
 Luminaire sur rail triphasée · surface revêtue de poudre · 4 optiques différentes · gradable par Bluetooth ou DALI

SYS 40W L: 858mm LM
 666-1001030RWWXXY 6060 - 6590

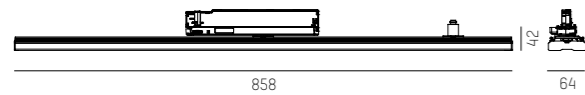

IP20

COMPLETE CODE			
R = BEAM ANGLE	WW = LIGHT COLOUR	XX = COLOUR	Y = DIMMABLE
wide = 1	LED 2700K = 13 CRI>80	grey = 04	switchable = 0
asymmetric = 2	LED 3000K = 19 CRI>80	white = 05	PULSE DALI dimm. = p
medium = 3	LED 4000K = 14 CRI>80	black = 06	BLUETOOTH dimm. = b
double sasymmetric = 4			

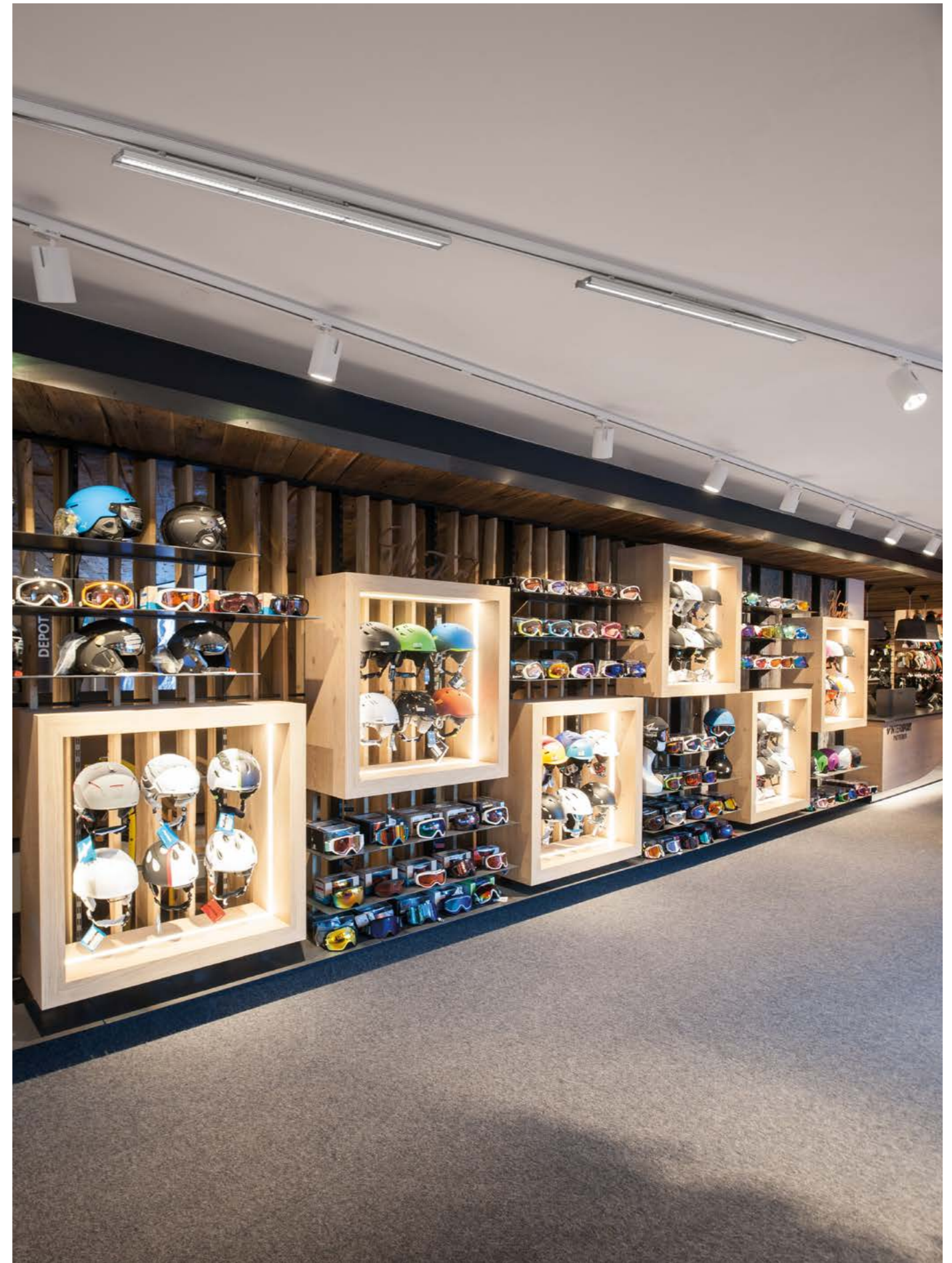

Technical data and energy efficiency



TRAIL TRACK

Intersport Patterer
 Krimml, Austria
 Photo: Joachim Rauch



Version



track

Core Colours



white



black

Creative Colours



copper



berlin blue



gold



berry blue



merlot



terra



grey



highland green



creme



sepia



anthrazit



forest



bronze

LED Colour



2700K



3000K



4000K

Special



minimum glare / UGR<19

THE SLIM ALLROUNDER

Varido kombiniert alle wichtigen Eigenschaften moderner Stromschienenleuchten. Sich verändernde Raumgegebenheiten stellen ab sofort keine Herausforderung mehr dar. Der frei um 350° schwenkbare Lichteinsatz ermöglicht maximale Flexibilität auf der Schiene. Eine perfekte Entblendung von UGR<16 erzielt Varido mittels eines schwarzen Hochglanzrasters in Kombination mit zurückversetzten, speziell abgestimmten Linsen. Zudem beeindruckt die absolut homogene Abstrahlcharakteristik bei einer sehr breiten Lichtverteilung. Das schlanke und zurückhaltende Erscheinungsbild garantiert eine flüssige Integration in unterschiedlichste Raumkonzepte.

Varido combines all essential characteristics of modern bus bar luminaires. Changing room characteristics are no longer a challenge. The luminaire insert that is freely swivelling by 350° ensures maximum flexibility on the rail. Varido offers optimum glare control of UGR<16 by means of a black high-gloss mesh in combination with recessed, especially adapted lenses. On top of that, it stands out with its absolutely homogenous beam characteristic while offering a very broad light distribution. The lean and modest appearance guarantees a smooth integration into highly diverse space concepts.

Design: INHOUSE

VARIDO



VARIDO TRACK

220-240V AC 50/60Hz UGR<19

Design: INHOUSE

Stromschienenleuchte aus Metall · Oberfläche pulverbeschichtet · Breitstrahlend · Leuchte 350° drehbar
 Sheet metal LED track luminaire · surface powder coated · wide-beam · luminaire 350° swiveling
 Lampada da binario in metallo · superfice verniciata a polveri · Fascio largo · Girevole a 350°
 Luminaire à rail métallique · surface revêtue de poudre · Large faisceau · luminaire orientable à 350°

SYS 47W	L: 846mm	LM
679-1010302WWXXY		4550 - 4810

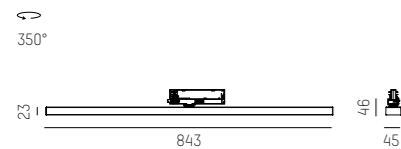

IP20 CE

COMPLRTE CODE		
WW = LIGHT COLOUR	XX = COLOUR	Y = DIMMABLE
W2 LED 2700K = 13 CRI>80	W white = 55	S switchable = 0
W3 LED 3000K = 19 CRI>80	S black = 66	P PULSE DALI dimm. = p
W4 LED 4000K = 14 CRI>80		B BLUETOOTH dimm. = b

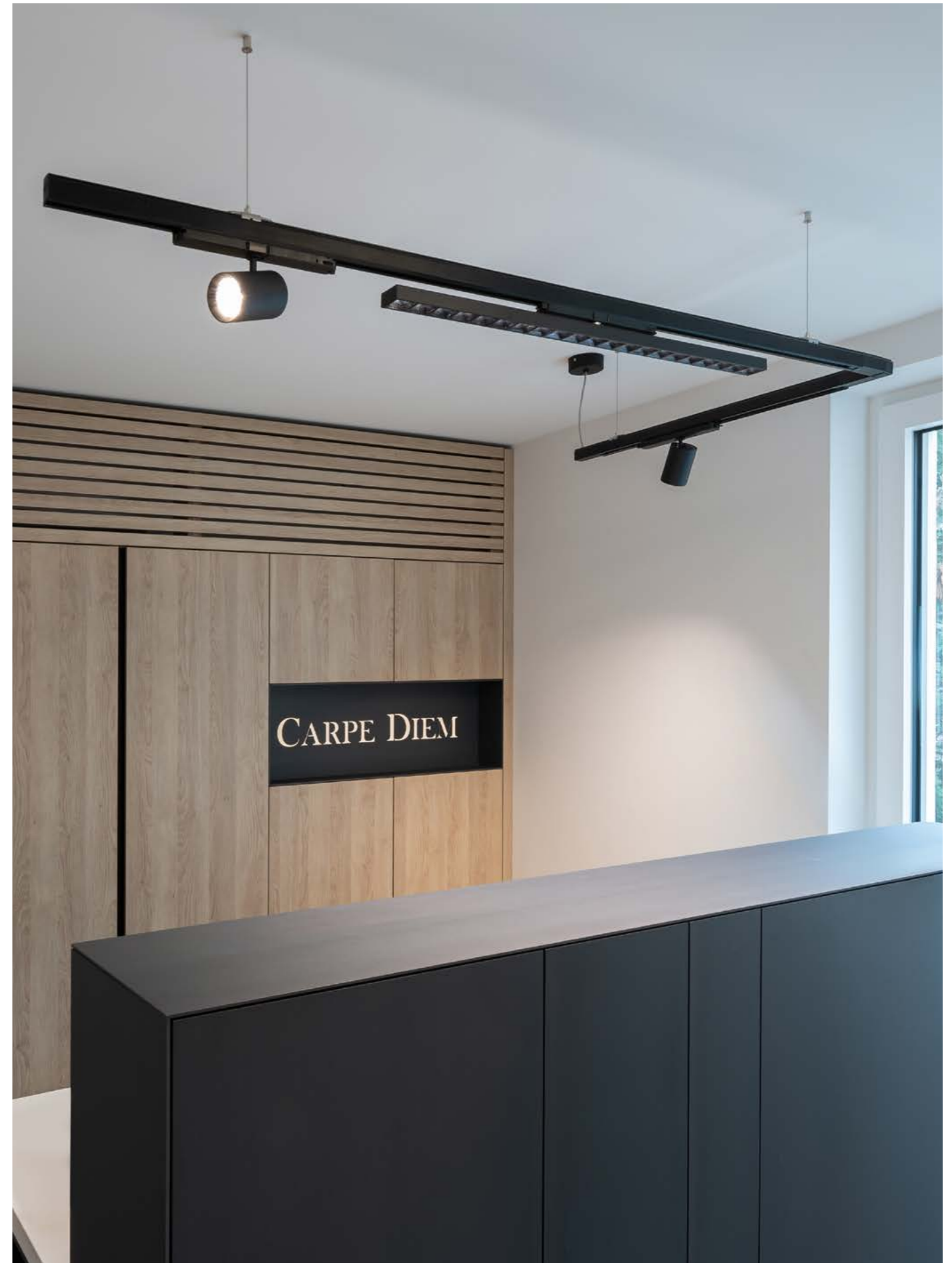

For technical data and energy efficiency

Carpe Diem
 Linz, Austria
 Photo: Joachim Rauch



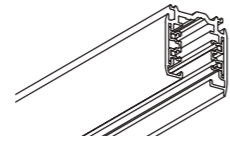
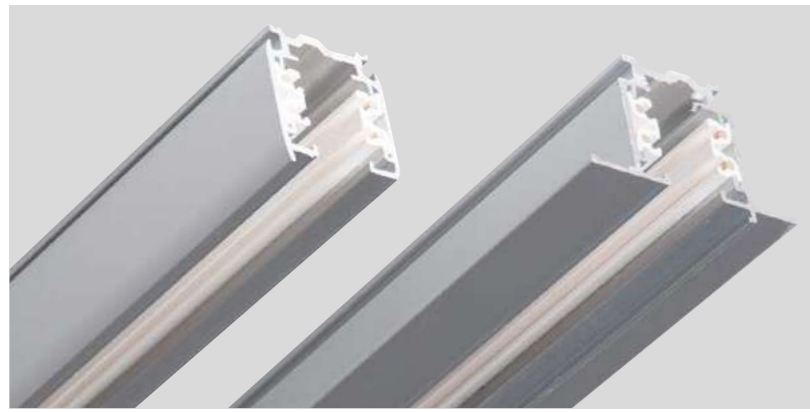

Info track & accessoires



3 PHASE TRACK SD

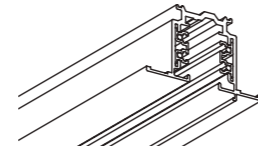

Info track & accessoires



3 PHASE TRACK R

3-PHASE TRACK

220-240V AC 50/60Hz

3-Phasen Stromschiene aus Aluminiumprofil · Oberfläche pulverbeschichtet · Installation als Aufbau, Einbau- und Pendelmontage · Zubehör separat ordern
 3-phase rail made of aluminium · surface powder-coated · surface, recessed or suspended mount · Order accessories separately
 Binario trifase in alluminio · superficie verniciata a polveri · Montaggio a soffitto, incasso o sospensione · Ordinare gli accessori separatamente
 Rail à 3 phases en aluminium · surface thermolaquée · Montage à plafon, encastre ou suspension · Commander les accessoires séparément

3-PHASEN SCHIENE AUFBAU / ABGEHÄNGT

3-PHASE TRACK SURFACE / PENDANT	LÄNGE LENGHT
208-1910410X	1000mm
208-1910420X	2000mm
208-1910430X	3000mm
208-1910440X	4000mm

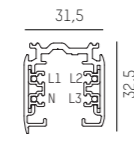

3-PHASEN SCHIENE EINBAU

3-PHASE TRACK RECESSED	LÄNGE LENGHT
208-1910510X	1000mm
208-1910520X	2000mm
208-1910530X	3000mm

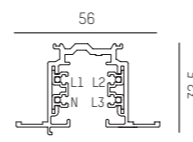

IP20

COMPLETE CODE FOR TRACK

X = COLOUR

black = 2	white = 3	grey = 5
-----------	-----------	----------

**ENDKAPPE
END PIECE**

208-1917041X



Alle Stromschiene müssen mit einer Endkappe versehen werden!
 All track endings have to be equipped with endpieces!

**BIEGEWERKZEUG
BENDING TOOL**

208-19135121

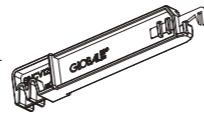

Zum Biegen der Stromleiter bei gekürzter Schiene
 for easy conductor bending with shortened rails

POWER FEED

**ENDEINSPEISUNG
END POWER FEED**

208-1917011X 66mm

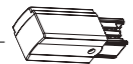

Schutzleiter rechts / Earth right

**MITTELEINSPEISUNG
CENTER POWER FEED**

208-1917014X 100mm

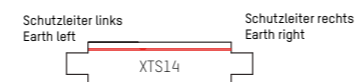

Schutzleiter links Earth left Schutzleiter rechts Earth right

**ENDEINSPEISUNG
END POWER FEED**

208-1917012X 66mm



Schutzleiter links / Earth left

COMPLETE CODE FOR TRACK

X = COLOUR

grey = 1	black = 2	white = 3
----------	-----------	-----------

JUNCTION

**LINEARVERBINDER
LINEAR JUNCTION ELECTRIC**

208-1917021X

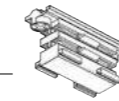

**FLEXVERBINDER
FLEXIBLE JUNCTION**

208-1917023X 175mm
 biegebar 0 - 360° / bendable 0 - 360°

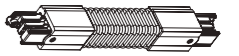

**WINKELVERBINDER
FLEXIBLE JUNCTION**

208-1917024X 160mm
 biegebar 60 - 300° / bendable 60 - 300°

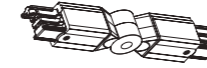

**X-VERBINDER
X-JUNCTION**

208-1917038X 100x100mm

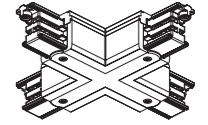

Mit Einspeisemöglichkeit / with optional power feed

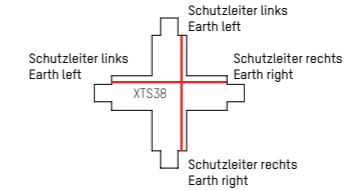

**L-VERBINDER
L-JUNCTION**

208-1917034X 66x66mm

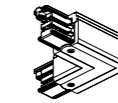

Mit Einspeisemöglichkeit / with optional power feed

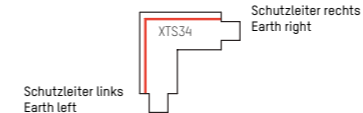

**L-VERBINDER
L-JUNCTION**

208-1917035X 66x66mm

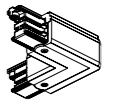

Mit Einspeisemöglichkeit / with optional power feed

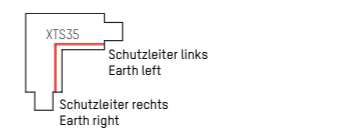

**T-VERBINDER
T-JUNCTION**

208-1917036X 100x66mm

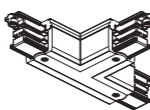

Mit Einspeisemöglichkeit / with optional power feed

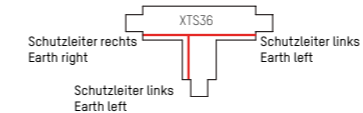

**T-VERBINDER
T-JUNCTION**

208-1917037X 100x66mm

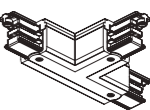

Mit Einspeisemöglichkeit / with optional power feed

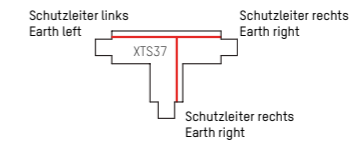

**T-VERBINDER
T-JUNCTION**

208-1917039X 100x66mm

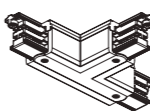

Mit Einspeisemöglichkeit / with optional power feed

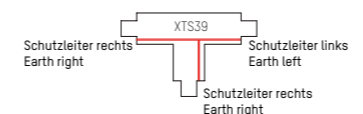

**T-VERBINDER
T-JUNCTION**

208-1917040X 100x66mm

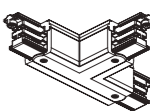

Mit Einspeisemöglichkeit / with optional power feed

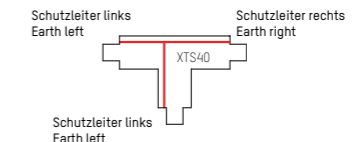

COMPLETE CODE FOR TRACK

X = COLOUR

grey = 1	black = 2	white = 3
----------	-----------	-----------

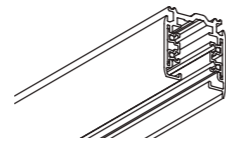
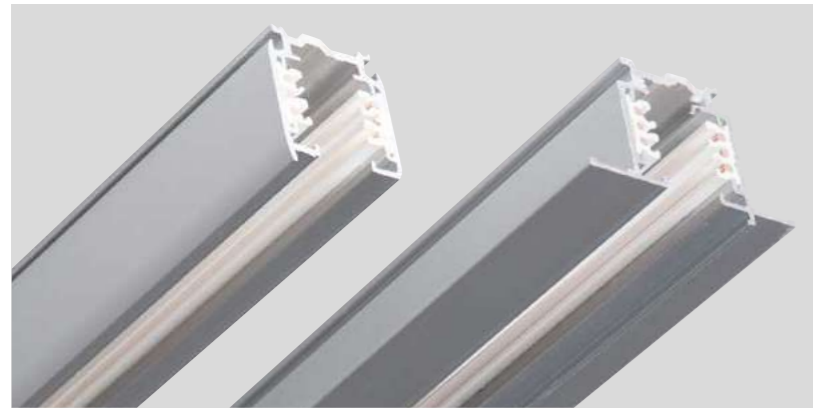

3 PHASE TRACK PULSE DALI SD

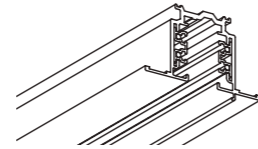

3 PHASE TRACK PULSE DALI R



3-PHASE TRACK PULSE DALI

220-240V AC 50/60Hz

3-Phasen Stromschiene aus Aluminiumprofil · Oberfläche pulverbeschichtet · Installation als Aufbau, Einbau- und Pendelmontage · Zubehör separat ordern
 3-phase rail made of aluminium · surface powder-coated · surface, recessed or suspended mount · Order accessories separately
 Binario trifase in alluminio · superficie verniciata a polveri · Montaggio a soffitto, incasso o sospensione · Ordinare gli accessori separatamente
 Rail à 3 phases en aluminium · surface thermolaquée · Montage à plafon, encastre ou suspension · Commander les accessoires séparément

3-PHASEN SCHIENE AUFBAU / ABGEHÄNGT

3-PHASE TRACK SURFACE / PENDANT	LÄNGE LENGHT
208-1910610X	1000mm
208-1910620X	2000mm
208-1910630X	3000mm
208-1910640X	4000mm

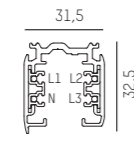

3-PHASEN SCHIENE EINBAU

3-PHASE TRACK RECESSED	LÄNGE LENGHT
208-1910650X	1000mm
208-1910660X	2000mm
208-1910670X	3000mm

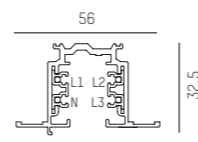

IP20 CE

COMPLETE CODE FOR TRACK

X = COLOUR

G grey = 1	S black = 2	W white = 3
-------------------	--------------------	--------------------

ENDKAPPE END PIECE

208-1917041X



Alle Stromschiene müssen mit einer Endkappe versehen werden!
 All track endings have to be equipped with endpieces!

BIEGEWERKZEUG BENDING TOOL

208-19135121

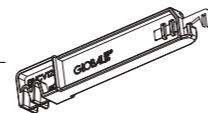

Zum Biegen der Stromleiter bei gekürzter Schiene
 for easy conductor bending with shortened rails

POWER FEED

ENDEINSPEISUNG

END POWER FEED

208-191c611X 90mm

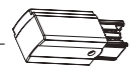

MITTELEINSPEISUNG

CENTER POWER FEED

208-191nc614X 150mm



ENDEINSPEISUNG

END POWER FEED

208-191c612X 90mm



COMPLETE CODE FOR TRACK

X = COLOUR

G grey = 1	S black = 2	W white = 3
-------------------	--------------------	--------------------

JUNCTION

LINEARVERBINDER ELEKTRISCH

LINEAR JUNCTION ELECTRIC

208-191d621X

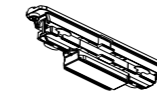

FLEXVERBINDER

FLEXIBLE JUNCTION

208-191c623X

LÄNGE

LENGHT

223mm

biegbar 0 - 360° / bendable 0 - 360°

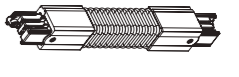

X-VERBINDER

X-JUNCTION

208-191nc638X

LxB

LxW

150x150mm

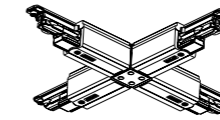

Mit Einspeisemöglichkeit / with optional power feed

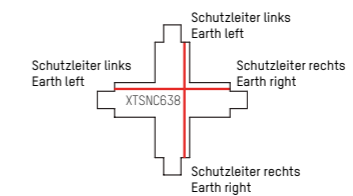

L-VERBINDER

L-JUNCTION

208-191nc634X

LxB

LxW

91x91mm

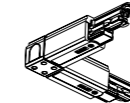

Mit Einspeisemöglichkeit / with optional power feed

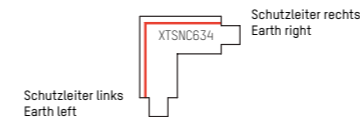

L-VERBINDER

L-JUNCTION

208-191nc635X

LxB

LxW

91x91mm

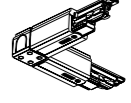

Mit Einspeisemöglichkeit / with optional power feed

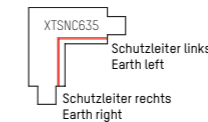

T-VERBINDER

T-JUNCTION

208-191nc636X

LxB

LxW

150x91mm

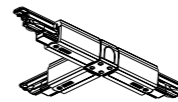

Mit Einspeisemöglichkeit / with optional power feed

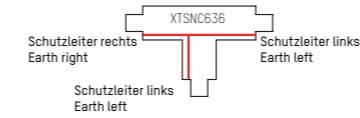

T-VERBINDER

T-JUNCTION

208-191nc637X

LxB

LxW

150x91mm

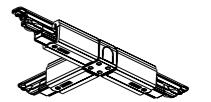

Mit Einspeisemöglichkeit / with optional power feed

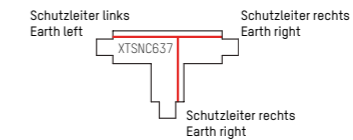

T-VERBINDER

T-JUNCTION

208-191nc639X

LxB

LxW

150x91mm

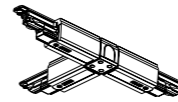

Mit Einspeisemöglichkeit / with optional power feed

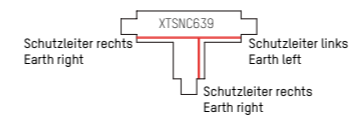

T-VERBINDER

T-JUNCTION

208-191nc640X

LxB

LxW

150x91mm

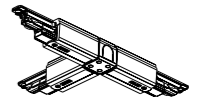

Mit Einspeisemöglichkeit / with optional power feed

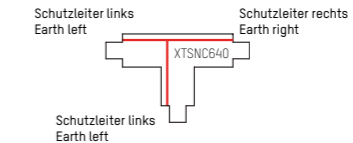

COMPLETE CODE FOR TRACK

X = COLOUR

G grey = 1	S black = 2	W white = 3
-------------------	--------------------	--------------------

FIXING COMPONENTS

ABHÄNGESSET SUSPENSION SET	FARBE COLOUR	LÄNGE LENGHT
208-19003	W	1500mm
208-19002	S	1500mm
208-19001	G	1500mm

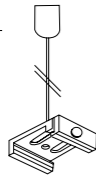

ABHÄNGESSET SUSPENSION SET	FARBE COLOUR	LÄNGE LENGHT
208-19005	W	3000mm
208-19006	S	3000mm
208-19004	G	3000mm

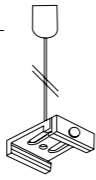

MONTAGEBÜGEL INSTALLATION BRACKET	FARBE COLOUR
775-hv60000808	G

für 3-Phasen Einbauschiene, inkl Schraube M 4x60
for 3-phase recessed track, incl screw M 4x60

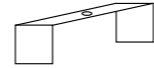

DECKENHALTERUNG SURFACE FIXATION	FARBE COLOUR
208-19180123	W
208-19180122	S
208-19180121	AE



DECKENBEFESTIGUNG SURFACE FIXATION	FARBE COLOUR
208-19180116	W
208-19180115	S
208-19180114	G



STAHLSEIL STEEL CABLE	LÄNGE LENGTH
208-19190501	per meter

beliebig kürzbar, Ø 1,5mm
cut to any length, Ø 1,5mm



SCHNELLBESTIGUNGSSET FAST FIXATION SET	FARBE COLOUR
639-as	N



Stahlseil und Deckenbefestigungsset separat ordern
order steel cable & ceiling fixation separately

KABELABHÄNGUNGSSET CABLE SUSPENSION SET	LÄNGE LENGTH
639-s3000	3000mm
639-s6000	6000mm

beliebig kürzbar, Ø 1,2mm
cut to any length, Ø 1,2mm

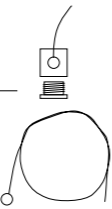

DECKENBEFESTIGUNGSSET CEILING FIXATION	FARBE COLOUR
5-plsb	N

2 Halterungen + 2 Kabelfixierungen
2 holders + 2 cable fix



COMPONENTS

MULTIADAPTER TRACK

ADAPTER ADAPTER	FARBE COLOUR	LxBxH LxWxH
208-19130681	W	85x30x55
208-19130685	S	85x30x55
208-19130684	G	85x30x55

Tragkraft: 10kg /payload: 10kg

MULTIADAPTER TRACK

ADAPTER ADAPTER	FARBE COLOUR	LxBxH LxWxH
208-19130698	W	70x30x40
208-19130697	S	70x30x40
208-19130696	G	70x30x40

Tragkraft: 5kg /payload: 5kg

BLINDADAPTER TRACK

BLINDADAPTER BLINDADAPTER	FARBE COLOUR
208-19162173	W

Tragkraft: 10kg,
zur Aufhängung von Leuchten
payload: 10kg,
for mounting luminaires



MULTIADAPTER PULSE DALI TRACK

ADAPTER ADAPTER	FARBE COLOUR	LxBxH LxWxH
208-19137403	W	105x30x55
208-19137402	S	105x30x55
208-19137401	G	105x30x55

Tragkraft: 10kg /payload: 10kg

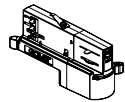

MULTIADAPTER PULSE DALI TRACK

ADAPTER ADAPTER	FARBE COLOUR	LxBxH LxWxH
208-19137503	W	105x30x40
208-19137502	S	105x30x40
208-19137501	G	105x30x40

Tragkraft: 5kg /payload: 5kg

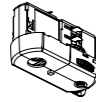

ZUGENTLASTUNG CORD GRIP	FARBE COLOUR
208-19825016	W
208-19825019	S

Zum Aufschrauben auf Alu-Nippel M10
for fixation on barrel nipple M10



ZUGENTLASTUNG CORD GRIP	FARBE COLOUR
208-19130133	W
208-19130132	S

Zum Aufschrauben auf Alu-Nippel M13
for fixation on barrel nipple M13



ALUNIPPEL / BARREL NIPPLE

NIPPEL NIPPLE	FARBE COLOUR	GRÖSSE SIZE
208-19130551	W	M 13x1
208-19130571	W	M 10x1

L: 12mm, zum fixation von Strahlern am Adapter
L: 12mm, for fixation spotlight to adapter

L: 12mm, zum fixation von Strahlern am Adapter
L: 12mm, for fixation spotlight to adapter

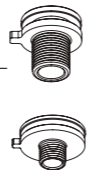

SCHUKO ADAPTER BLINDADAPTER	FARBE COLOUR
208-19130678	W

16A



COMPONENTS

COVER FOR 3-PHASE TRACK

ABDECKPLATTE COVERPLATE	FARBE COLOUR
208-19172303	W
208-19172302	S
208-19172301	G

für T, L und X Verbinder
nur für Einbauschiene
for T, L and X junction
for recessed track only

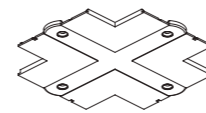

COVER FOR 3-PHASE PULSE DALI TRACK

ABDECKPLATTE COVERPLATE	FARBE COLOUR
208-191f6303	W
208-191f6302	S
208-191f6301	G

für T, L und X Verbinder
nur für Einbauschiene
for T, L and X junction
for recessed track only

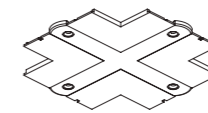

COVER FOR 3-PHASE TRACK

ABDECKPLATTE COVERPLATE	FARBE COLOUR
208-19172103	W
208-19172102	S
208-19172101	G

für Mittel- und Endeinspeisung
nur für Einbauschiene
for center and end power feed
for recessed track only

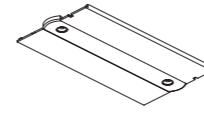

COVER FOR 3-PHASE PULSE DALI TRACK

ABDECKPLATTE COVERPLATE	FARBE COLOUR
208-191f6103	W
208-191f6102	S
208-191f6101	G

für Mittel- und Endeinspeisung
nur für Einbauschiene
for center and end power feed
for recessed track only

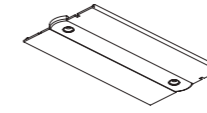

ADAPTER FÜR DEKOHAKEN ADAPTER FOR DECO HOOK	FARBE COLOUR
208-19160143	W
208-19160142	S
208-19160141	G

zum einklippen in die Schiene
to clip into rail



DEKOHAKEN DECO HOOK	FARBE COLOUR
208-19160111	G

Adapter separat ordern
order adapter separately



Intersport Tscherne
Salzburg, Austria
Photo: Joachim Rauch





SAVO 10 R

Design: INHOUSE



Einbaudownlight aus Aluminium · Oberfläche pulverbeschichtet · vakuumbedampfter Alurefektor · Strahlerelement dreh- und schwenkbar
 Aluminium downlighter · surface powder-coated · vacuum deposited reflector · swiveling and tilting
 Incasso in alluminio · superficie verniciata a polveri · ottiche in 3 fasci di emissione · girevole e orientabile
 Encastré en aluminium · surface laquée en poudre · réflecteur en 3 angles d'émission · tournant et pivotant

LED 12W - 350mA	LM
LED 17W - 500mA	
LED 24W - 700mA	
633-00101RRWWXXv1	1210 - 2850

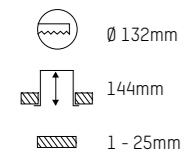
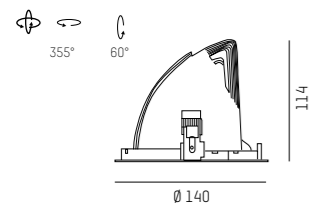

LED CONVERTER	mA	DIMM	FOR
24-127530n	350	not dimmable	1 x SAVO 10 12W
24-127532n	500	not dimmable	1 x SAVO 10 17W
24-127534n	700	not dimmable	1 x SAVO 10 24W
24-127490	350 - 700	DALI dimmable	1 x SAVO 10 12 - 24W

IP20

COMPLETE CODE		
RR = REFLECTOR	WW = LIGHT COLOUR	XX = COLOUR
15° spot = 02	LED 2700K = 43 PREMIUM CRI>90	white = 05
28° medium = 05	LED 3000K = 49 PREMIUM CRI>90	
40° flood = 08	LED 4000K = 24 CRI>90	



Technical data and energy efficiency



SAVO 10 R

Intersport
 St. Pölten, Austria
 Photo: Joachim Rauch



SAVO 20 ROUND R

Design: INHOUSE



Einbaudownlight aus Aluminium · Oberfläche pulverbeschichtet · vakuumbedampfter Alureflektor · Strahlerelement schwenkbar
 Aluminium downlighter · surface powder-coated · vacuum deposited reflector · tilting
 Incasso in alluminio · superficie verniciata a polveri · ottiche in 3 fasci di emissione · orientabile
 Encastré en aluminium · surface laquée en poudre · réflecteur en 3 angles d'émission · pivotant

LED 12W - 350mA	LM
LED 17W - 500mA	
LED 24W - 700mA	
633-00201RRWWXXv1	1250 - 2940

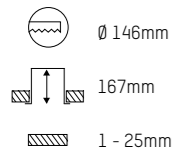
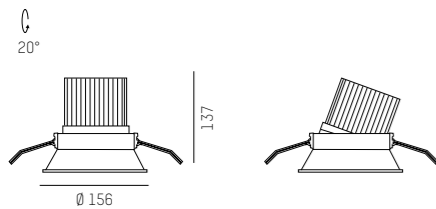

LED CONVERTER	mA	DIMM	FOR
24-127530n	350	not dimmable	1 x SAVO 20 ROUND 12W
24-127532n	500	not dimmable	1 x SAVO 20 ROUND 17W
24-127534n	700	not dimmable	1 x SAVO 20 ROUND 24W
24-127490	350 - 700	DALI dimmable	1 x SAVO 20 ROUND 12 - 24W

IP20

COMPLETE CODE		
RR = REFLECTOR	WW = LIGHT COLOUR	XX = COLOUR
16° spot = 02	LED 2700K = 43 PREMIUM CRI>90	white = 05
24° medium = 05	LED 3000K = 49 PREMIUM CRI>90	black = 06
40° flood = 08	LED 4000K = 24 CRI>90	

314



SAVO 20 ROUND R

Technical data and energy efficiency



Object Carpet GmbH / City of Visions
 Denkendorf, Germany
 Photo: Markus Guhl

SAVO 20 ROUND R

315

BACK TO CONTENT



SAVO 20 SQUARE R

Design: INHOUSE



Einbaudownlight aus Aluminium · Oberfläche pulverbeschichtet · vakuumbedampfter Alurefektor · Strahlerelement dreh- und schwenkbar
 Aluminium downlighter · surface powder-coated · vacuum deposited reflector · tilting and pivoting
 Incasso in alluminio · superficie verniciata a polveri · ottiche in 3 fasci di emissione · orientabile
 Encastré en aluminium · surface laquée en poudre · réflecteur en 3 angles d'émission · pivotant

SAVO 20 SQUARE R

LED 12W - 350mA	LM
LED 17W - 500mA	
LED 24W - 700mA	
633-00301RRWWXXv1	1250 - 2940

SAVO 20 SQUARE DOUBLE R

2 x LED 12W - 2 x 350mA	LM
2 x LED 17W - 2 x 500mA	
2 x LED 24W - 2 x 700mA	
633-00302RRWWXXv1	2500 - 5880

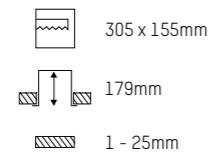
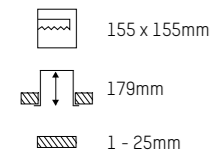
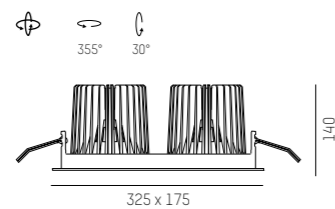
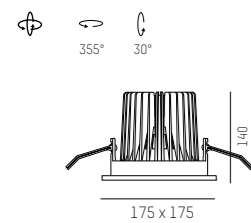

LED CONVERTER	mA	DIMM	ORDER FOR
24-127530n	350	not dimmable	1 x SAVO 20 SQUARE 12W / 2 x SAVO 20 SQUARE DOUBLE 2 x 12W
24-127532n	500	not dimmable	1 x SAVO 20 SQUARE 17W / 2 x SAVO 20 SQUARE DOUBLE 2 x 17W
24-127534n	700	not dimmable	1 x SAVO 20 SQUARE 24W / 2 x SAVO 20 SQUARE DOUBLE 2 x 24W
24-127490	350 - 700	DALI dimmable	1 x SAVO 20 SQUARE 12 - 24W / 2 x SAVO 20 SQUARE DOUBLE 2 x 12 - 24W

IP20

COMPLETE CODE		
RR = REFLECTOR	WW = LIGHT COLOUR	XX = COLOUR
16° spot = 02	LED 2700K = 43 PREMIUM CRI>90	white = 05
24° medium = 05	LED 3000K = 49 PREMIUM CRI>90	black = 06
40° flood = 08	LED 4000K = 24 CRI>90	



SAVO 20 SQUARE R

Technical data and energy efficiency



SAVO 20 SQUARE R



SAVO 20 SQUARE DOUBLE R

Romeo & Juliet
 Perg, Austria
 Photo: Joachim Rauch



SAVO 20 S SQUARE R

Design: INHOUSE



Einbaudownlight aus Aluminium · Oberfläche pulverbeschichtet · vakuumbedampfter Alureflektor · Strahlerelement dreh- schwenkbar
 Aluminium downlighter · surface powder-coated · vacuum deposited reflector · tilting and pivoting
 Incasso in alluminio · superficie verniciata a polveri · ottiche in 3 fasci di emissione · orientabile
 Encastré en aluminium · surface laquée en poudre · réflecteur en 3 angles d'émission · pivotant

SAVO 20 S SQUARE R

LED 12W - 350mA	LM
LED 18W - 500mA	
633-00501RRWWXXv1	1260 - 2110

SAVO 20 S SQUARE DOUBLE R

2 x LED 12W - 2 x 350mA	LM
2 x LED 18W - 2 x 500mA	
633-00502RRWWXXv1	2520 - 4220



355° 30°

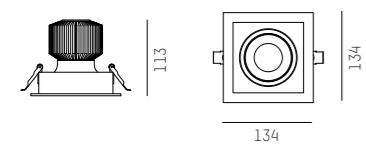

115 x 115mm
 149mm
 1 - 25mm



355° 30°

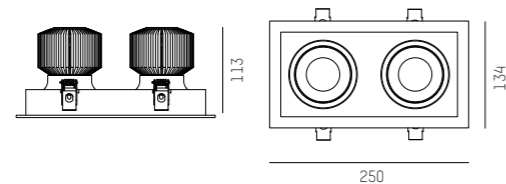

230 x 115mm
 149mm
 1 - 25mm

LED CONVERTER	mA	DIMM	ORDER FOR
24-127530n	350	not dimmable	1 x SAVO 20 S SQUARE 12W / 2 x SAVO 20 S SQUARE DOUBLE 2 x 12W
24-127532n	500	not dimmable	1 x SAVO 20 S SQUARE 18W / 2 x SAVO 20 S SQUARE DOUBLE 2 x 18W
24-127490	350 - 500	DALI dimmable	1 x SAVO 20 S SQUARE 12 - 18W / 2 x SAVO 20 S SQUARE DOUBLE 2 x 12 - 18W

IP20

COMPLETE CODE	RR = REFLECTOR	WW = LIGHT COLOUR	XX = COLOUR
24° medium = 05	LED 2700K = 43 PREMIUM CRI>90	white = 05	black = 06
45° flood = 08	LED 3000K = 49 PREMIUM CRI>90		
	LED 4000K = 24 CRI>90		

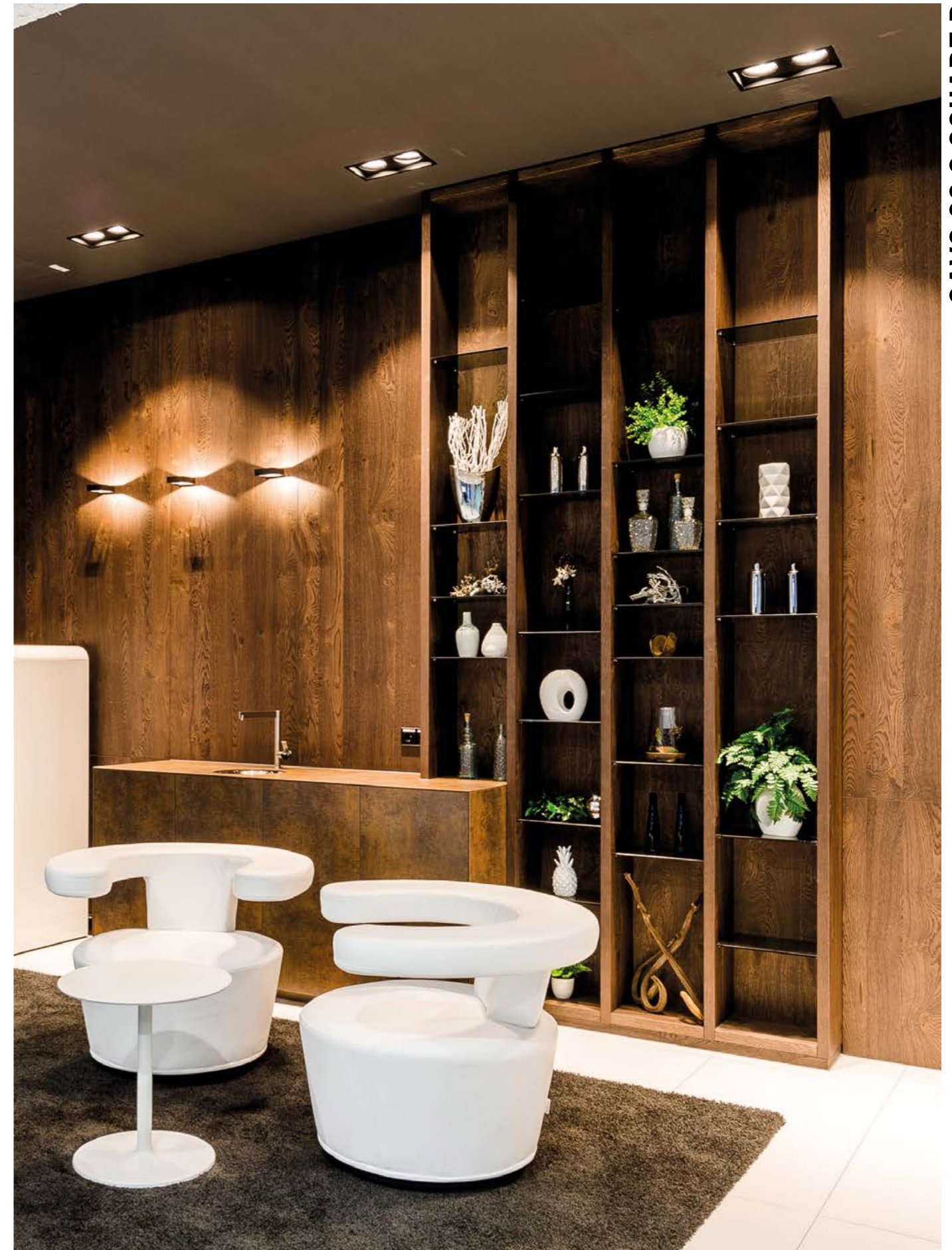

SAVO 20 S SQUARE R

Technical data and energy efficiency

Kreisel & Electrics
 Rainbach, Austria
 Planning/realisation: Ben Elmecker
 Photo: Kreisel Electric / Martin Pröll



SAVO 20 S SQUARE R



SAVO 20 S SQUARE DOUBLE R



NOW 2 ROUND R

Design: INHOUSE



Einbaudownlight aus Aluminium · Oberfläche pulverbeschichtet · vakuumbedampfter Alurefektor · Strahlerelement schwenkbar
 Aluminium downlighter · surface powder-coated · vacuum deposited reflector · tilting
 Incasso in alluminio · superficie verniciata a polveri · ottiche in 3 fasci di emissione · orientabile
 Encastré en aluminium · surface laquée en poudre · réflecteur en 3 angles d'émission · pivotant

LED 12W - 350mA	LM
LED 17W - 500mA	
635-00100RRWWXX	1270 - 2140

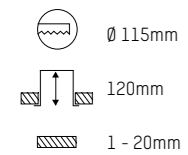
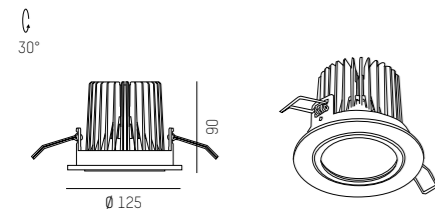

LED CONVERTER	mA	DIMM	FOR
24-127530n	350	not dimmable	1 x NOW 2 ROUND 12W
24-127532n	500	not dimmable	1 x NOW 2 ROUND 17W
24-127490	350 - 500	DALI dimmable	1 x NOW 2 ROUND 12 - 17W

IP20

COMPLETE CODE		
RR = BEAM ANGLE	WW = LIGHT COLOUR	XX = COLOUR
16° spot = 02	LED 2700K = 43 PREMIUM CRI>90	grey = 04
25° medium = 05	LED 3000K = 49 PREMIUM CRI>90	white = 05
40° flood = 08	LED 4000K = 24 CRI>90	black = 06

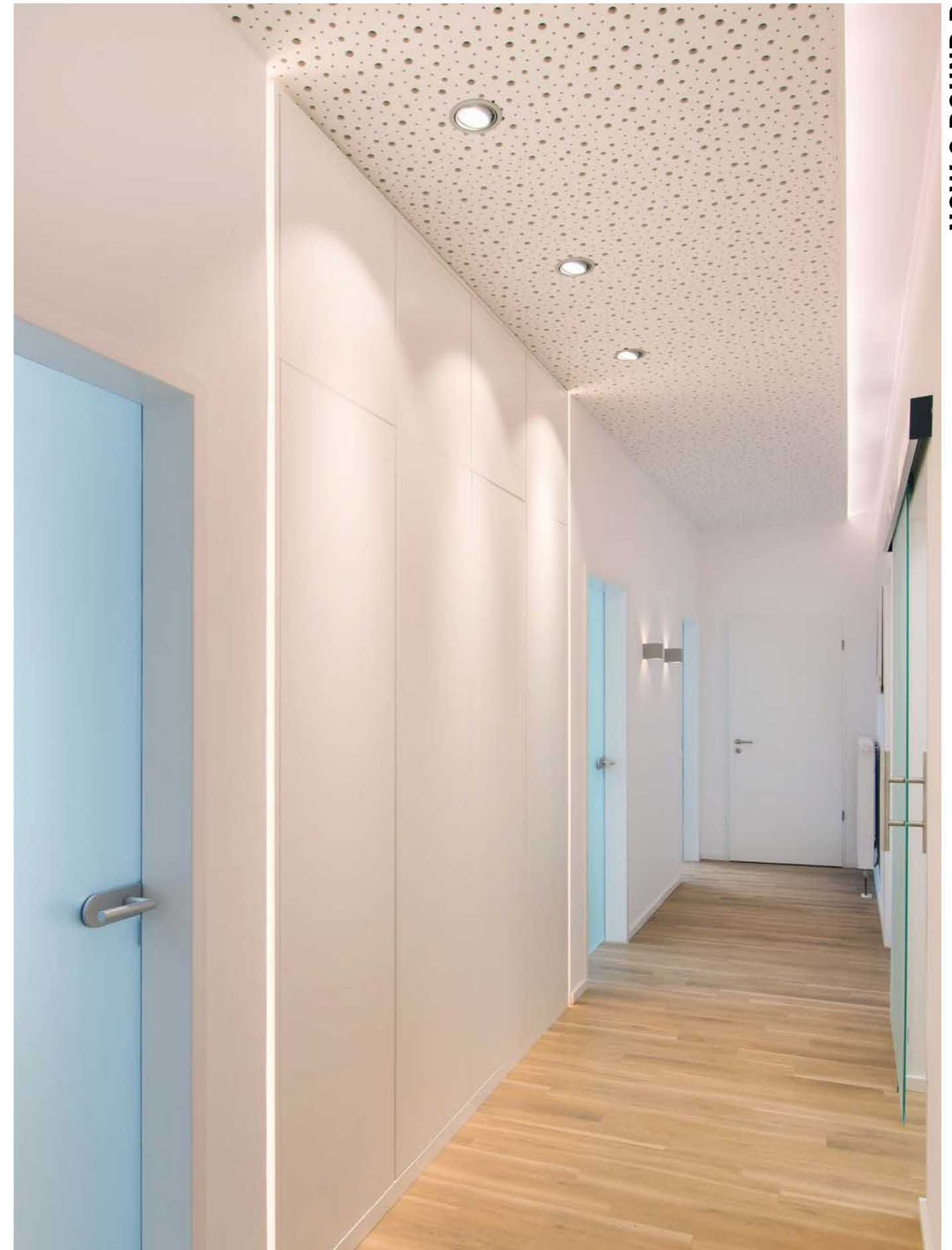

Technical data and energy efficiency





NOW 2 SQUARE R

Design: INHOUSE



Einbaudownlight aus Aluminium · Oberfläche pulverbeschichtet · vakuumbedampfter Alureflektor · Strahlerelement schwenkbar
 Aluminium downlighter · surface powder-coated · vacuum deposited reflector · tilting
 Incasso in alluminio · superficie verniciata a polveri · ottiche in 3 fasci di emissione · orientabile
 Encastré en aluminium · surface laquée en poudre · réflecteur en 3 angles d'émission · pivotant

NOW 2 SQUARE R

LED 12W - 350mA	LM
LED 17W - 500mA	
635-00200RRWWXX	1270 - 2140

NOW 2 SQUARE DOUBLE R

2 x LED 12W - 2 x 350mA	LM
2 x LED 17W - 2 x 700mA	
635-00300RRWWXX	2540 - 4280

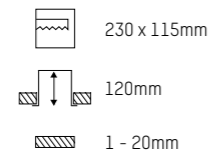
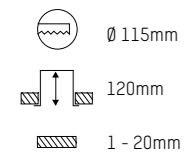
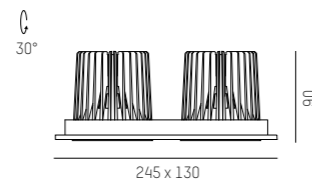
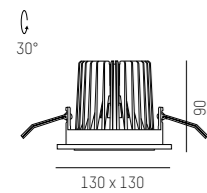

LED CONVERTER	mA	DIMM	ORDER FOR
24-127530n	350	not dimmable	1 x NOW 2 SQUARE 12W / 2 x NOW 2 SQUARE DOUBLE 2 x 12W
24-127532n	500	not dimmable	1 x NOW 2 SQUARE 17W / 2 x NOW 2 SQUARE DOUBLE 2 x 17W
24-127490	350 - 500	DALI dimmable	1 x NOW 2 SQUARE 12 - 17W / 2 x NOW 2 SQUARE DOUBLE 2 x 12 - 17W

IP20

COMPLETE CODE		
RR = BEAM ANGLE	WW = LIGHT COLOUR	XX = COLOUR
16° spot = 02	LED 2700K = 43 PREMIUM CRI>90	grey = 04
25° medium = 05	LED 3000K = 49 PREMIUM CRI>90	white = 05
40° flood = 08	LED 4000K = 24 CRI>90	black = 06

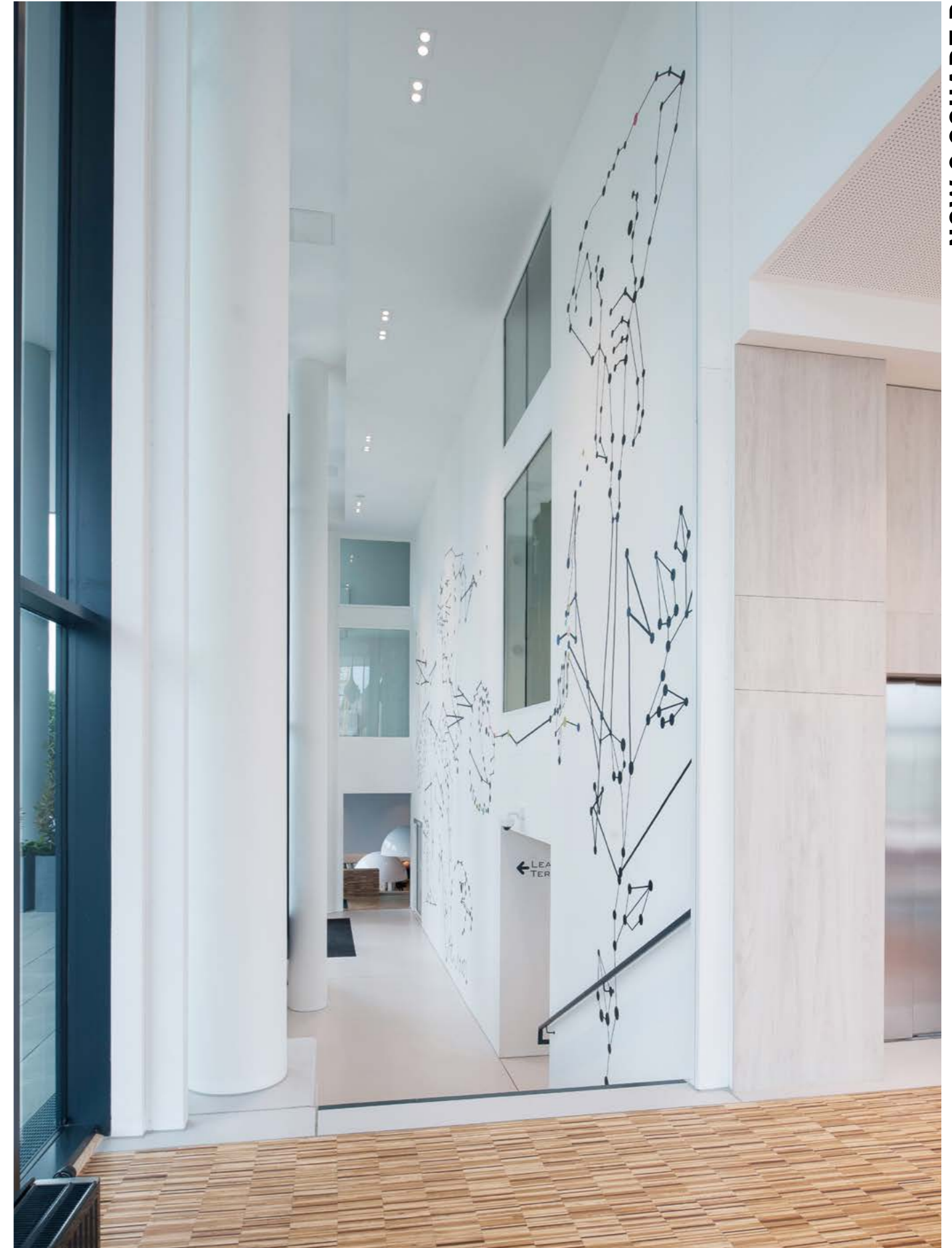

NOW 2 SQUARE R

Capera Linked Living Studios
 Vienna, Austria
 Photo: Joachim Rauch

Technical data and energy efficiency



NOW 2 SQUARE R



NOW 2 SQUARE DOUBLE R



ONLY XS R

Design: INHOUSE



Einbaudownlight aus Aluminium · Oberfläche pulverbeschichtet · vakuumbedampfter Alurefektor · Strahlerelement dreh- und schwenkbar
 Aluminium downlighter · surface powder-coated · vacuum deposited reflector · swiveling and tilting
 Incasso in alluminio · superficie verniciata a polveri · ottiche in 4 fasci di emissione · girevole e orientabile
 Encastré en aluminium · surface laquée en poudre · réflecteur en 4 angles d'émission · tournant et pivotant

LED 12W - 350mA	LM
LED 17W - 500mA	
LED 24W - 750mA	
619-00101RRWWXXv1	1270 - 2940

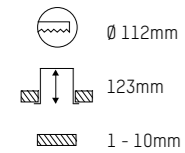
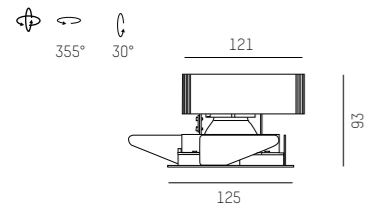

EINBAUGEHÄUSE 1	FARBE
RECESSED HOUSING 1	COLOUR
544-124	grey
544-125	white
544-126	black

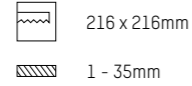
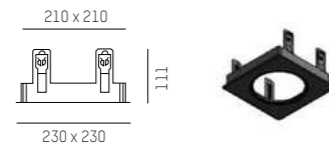

EINBAUGEHÄUSE 2	FARBE
RECESSED HOUSING 2	COLOUR
544-224	grey
544-225	white
544-226	black

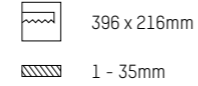
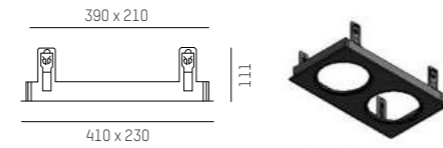

LED CONVERTER	mA	DIMM	FOR
24-127530n	350	not dimmable	1 x ONLY XS 12W
24-127532n	500	not dimmable	1 x ONLY XS 17W
24-127534n	700	not dimmable	1 x ONLY XS 24W
24-127490	350 - 700	DALI dimmable	1 x ONLY XS 12 - 27W

IP20

COMPLETE CODE		
RR = BEAM ANGLE	WW = LIGHT COLOUR	XX = COLOUR
15° spot = 02	LED 2700K = 43 PREMIUM CRI>90	grey = 04
20° medium = 05	LED 3000K = 49 PREMIUM CRI>90	white = 05
35° flood = 08	LED 4000K = 24 CRI>90	black = 06
60° wide flood = 09		

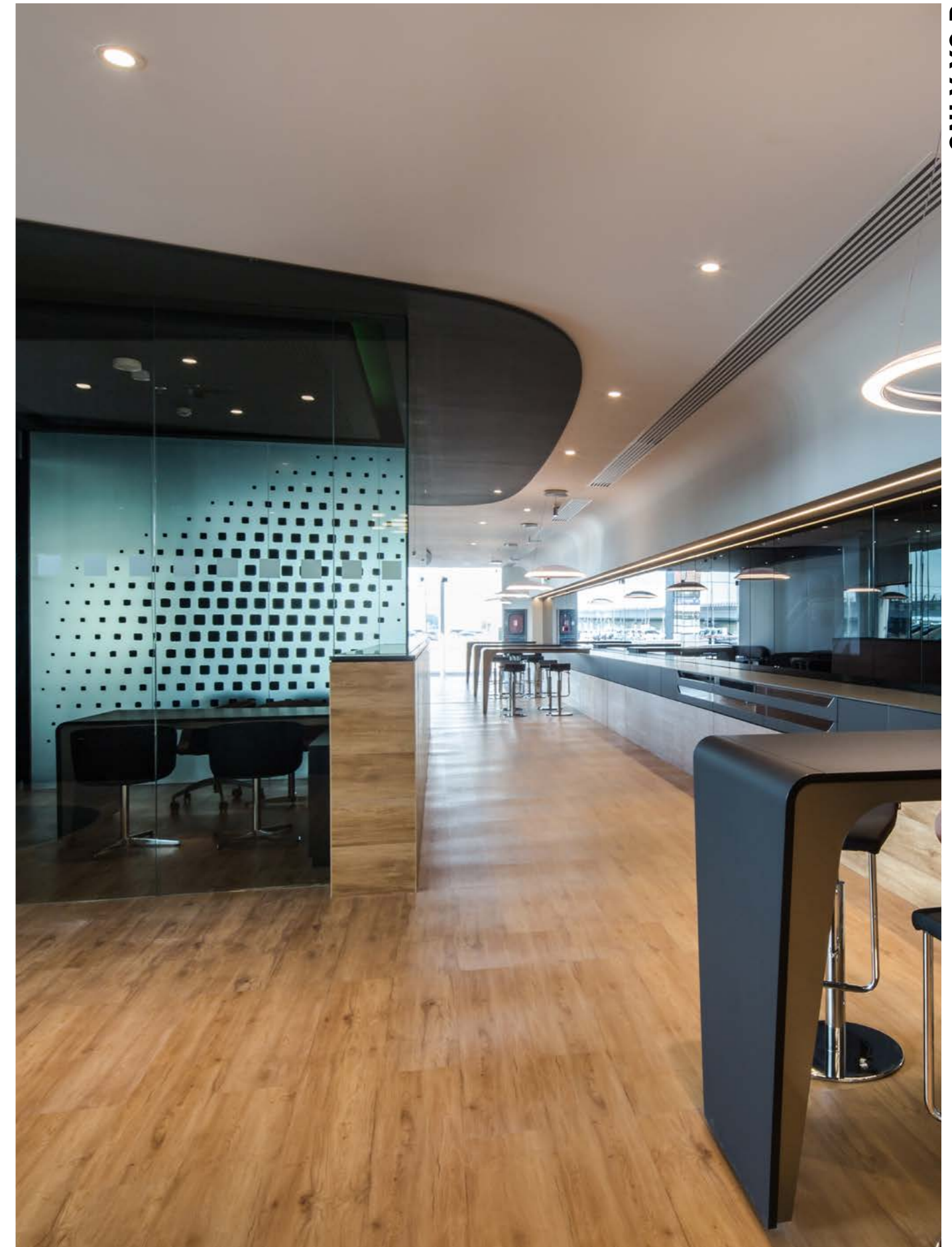

ONLY XS R

Technical data and energy efficiency



ONLY XS R

Mercedes Showroom
 Dubai, VAE
 Photo: yasserphotography.com



ONLY M R

Design: INHOUSE



Einbaudownlight aus Aluminium · Oberfläche pulverbeschichtet · vakuumbedampfter Alurefektor · Strahlerelement dreh- und schwenkbar
 Aluminium downlighter · surface powder-coated · vacuum deposited reflector · swiveling and tilting
 Incasso in alluminio · superficie verniciata a polveri · ottiche in 3 fasci di emissione · girevole e orientabile
 Encastré en aluminium · surface laquée en poudre · réflecteur en 3 angles d'émission · tournant et pivotant

LED 23W - 700mA	LM
LED 30W - 900mA	
LED 36W - 1050mA	
619-00201RRWWXXv1	2480 - 4270

EINBAUGEHÄUSE 1	FARBE
RECESSED HOUSING 1	COLOUR
544-114	grey
544-115	white
544-116	black

EINBAUGEHÄUSE 2	FARBE
RECESSED HOUSING 2	COLOUR
544-214	grey
544-215	white
544-216	black

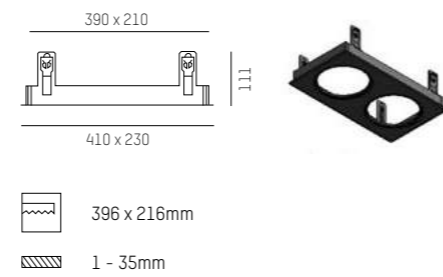
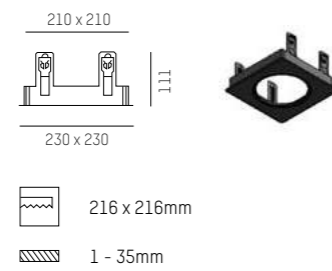
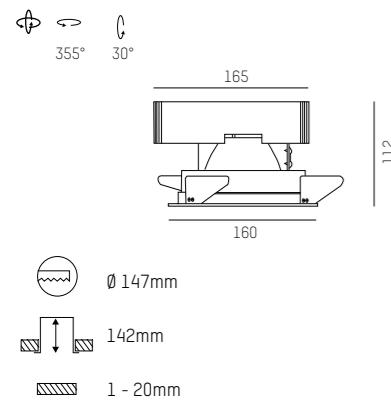

LED CONVERTER	mA	DIMM	FOR
24-127534n	700	not dimmable	1 x ONLY M 23W
24-127536n	900	not dimmable	1 x ONLY M 30W
24-127538n	1050	not dimmable	1 x ONLY M 36W
24-127490	700 - 1050	DALI dimmable	1 x ONLY M 23 - 36W

IP20

COMPLETE CODE		
RR = BEAM ANGLE	WW = LIGHT COLOUR	XX = COLOUR
17° spot = 02	LED 2700K = 43 PREMIUM CRI>90	grey = 04
29° medium = 05	LED 3000K = 49 PREMIUM CRI>90	white = 05
40° flood = 08	LED 4000K = 24 CRI>90	black = 06

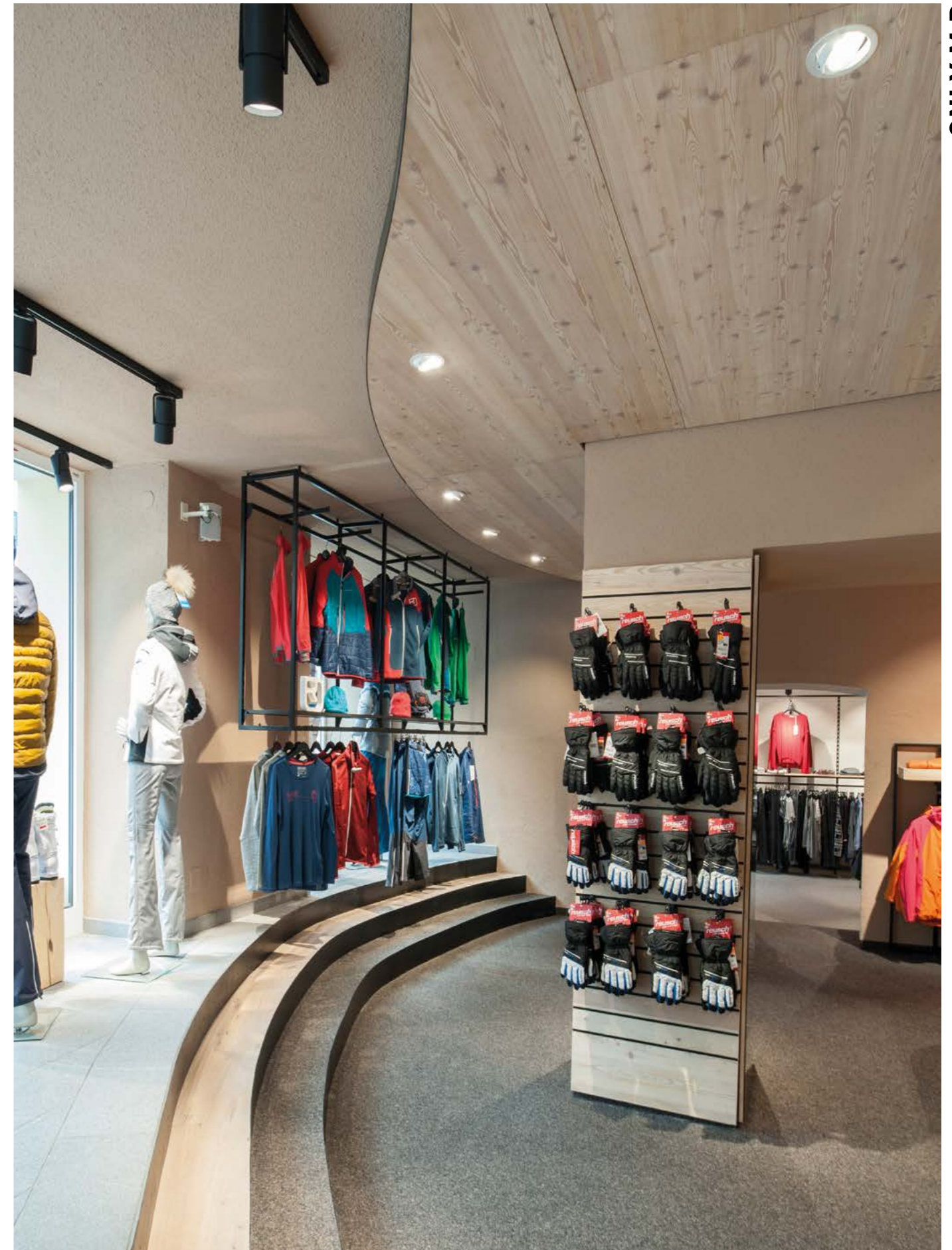

ONLY M R

Technical data and energy efficiency



ONLY M R

Intersport Bachler
 Schladming, Austria
 photo: Joachim Rauch



GET FLAT mit flachem opalem od. mikroprismatischem Diffusor / IP44
GET FLAT with flat opal or microprismatic diffuser / IP44



GET REFL mit Reflektor und opalem od. mikroprismatischem Diffusor / IP20
GET REFL with reflector and opal or microprismatic diffuser / IP20

GET ROUND R

Design: INHOUSE

Einbaudownlight aus Aluminium · Oberfläche pulverbeschichtet · Reflektor mit breitstrahlender Lichtverteilung · Diffuser mit Mikroprisma oder Opaldiffusor
Aluminium downlighter · surface powder coated · flood reflector · Opal or microprismatic cover
Incasso in alluminio · superficie verniciata a polveri · riflettore flood · diffusore opale o microprismatico
Encastré en aluminium · surface laqué en poudres · réflecteur flood · diffuseur opal ou en microprisme

GET ROUND FLAT XS R

LED 10W - 350mA
LED 15W - 500mA
LED 20W - 700mA

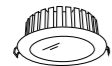

LM

468-1100CWWXX | 1182 - 2461
flache Abdeckung / 90° Ausstrahlung
flat cover / 90° light beam

GET ROUND FLAT M R

LED 21W - 700mA
LED 27W - 900mA
LED 31W - 1050mA

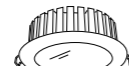

LM

468-1200CWWXX | 2482 - 4326
flache Abdeckung / 90° Ausstrahlung
flat cover / 90° light beam

GET AUFBAUGEHÄUSE GET SURFACE HOUSING

FÜR GET XS
FOR GET XS

FARBE
COLOUR

468-1125 | white
max. 500mA Version

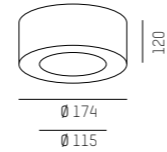

GET ROUND REFL XS R

LED 10W - 350mA
LED 15W - 500mA
LED 20W - 700mA

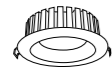

LM

468-1101CWWXX | 1150 - 2392
mit Reflektor / 100° Ausstrahlung
with reflector / 100° light beam

GET ROUND REFL M R

LED 21W - 700mA
LED 27W - 900mA
LED 31W - 1050mA

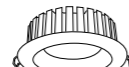

LM

468-1201CWWXX | 2502 - 4190
mit Reflektor / 100° Ausstrahlung
with reflector / 100° light beam

FÜR GET M
FOR GET M

FARBE
COLOUR

468-1225 | white
max. 900mA Version

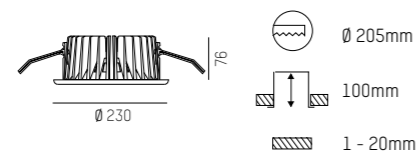
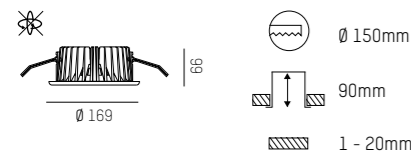
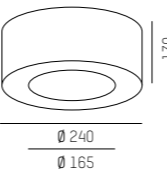

FÜR GET XS
FOR GET XS

FARBE
COLOUR

468-1115 | white



FÜR GET M
FOR GET M

FARBE
COLOUR

468-1215 | white

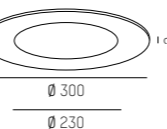

LED CONVERTER	mA	DIMM	FOR
24-127530n	350	not dimmable	1 x GET XS 10W
24-127532n	500	not dimmable	1 x GET XS 15W
24-127534n	700	not dimmable	1 x GET XS 20W / 1 x GET M 21W
24-127536n	900	not dimmable	1 x GET M 27W
24-127538n	1050	not dimmable	1 x GET M 31W
24-127490	350 - 700	DALI dimmable	1 x GET XS 10 - 20W / 1 x GET M 21 - 31W

IP40 / IP44



COMPLETE CODE		
C = COVER	WW = LIGHT COLOUR	XX = COLOUR
opal = 1	LED 3000K = 19 CRI>80	white = 55
microprismatic = 2 UGR<19	LED 4000K = 14 CRI>80	

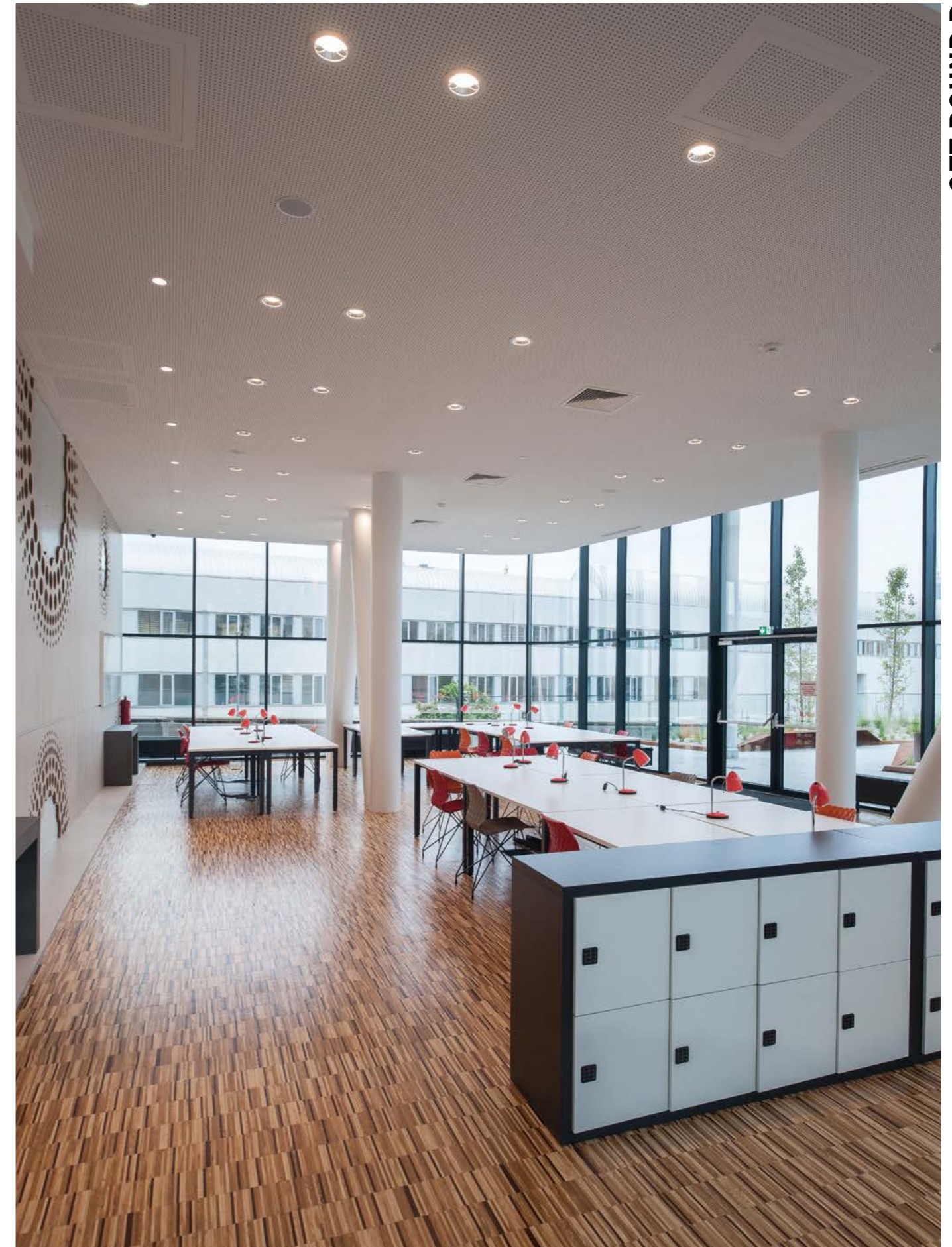

Capera Linked Living Studios
Vienna, Austria
Photo: Joachim Rauch

Technical data and energy efficiency



GET ROUND FLAT XS R



GET ROUND FLAT M R



GET ROUND REFL XS R



GET ROUND REFL M R

GET ROUND FLAT XS R
329



GET FLAT mit flachem opalem od. mikroprismatischem Diffusor / IP44
GET FLAT with flat opal or microprismatic diffuser / IP44



GET REFL mit Reflektor und opalem od. mikroprismatischem Diffusor / IP20
GET REFL with reflector and opal or microprismatic diffuser / IP20

GET SQUARE R

Design: INHOUSE

Einbaudownlight aus Aluminium · Oberfläche lackiert · Reflektor mit breitstrahlender Lichtverteilung · Diffuser mit Mikroprismanoptik oder Opaldiffusor
Aluminium downlighter · surface laquered · flood reflector · Opal or microprismatic cover
Incasso in alluminio · superficie verniciata · riflettore flood · diffusore opale o microprismatico
Encastré en aluminium · surface laqué · réflecteur flood · diffuseur opal ou en microprisme

GET SQUARE FLAT XS R



LED 10W - 350mA
LED 15W - 500mA
LED 20W - 700mA

LM

468-2100CWWXX 945 - 2113

flache Abdeckung / 90° Ausstrahlung
flat cover / 90° light beam

GET SQUARE FLAT M R



LED 21W - 700mA
LED 27W - 900mA
LED 31W - 1050mA

LM

468-2200CWWXX 2079 - 3824

flache Abdeckung / 90° Ausstrahlung
flat cover / 90° light beam

GET AUFBAUGEHÄUSE
GET SURFACE HOUSING

FÜR GET XS FOR GET XS	FARBE COLOUR
468-2125	white

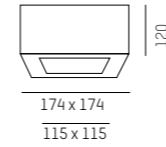

max. 500mA Version

FÜR GET M FOR GET M	FARBE COLOUR
468-2225	white

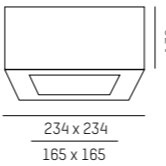

max. 900mA Version

GET SQUARE REFL XS R

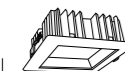

LED 10W - 350mA
LED 15W - 500mA
LED 20W - 700mA

LM

468-2101CWWXX 1229 - 2583

mit Reflektor / 100° Ausstrahlung
with reflector / 100° light beam

GET SQUARE REFL M R

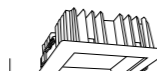

LED 21W - 700mA
LED 27W - 900mA
LED 31W - 1050mA

LM

468-2201CWWXX 2664 - 4372

mit Reflektor / 100° Ausstrahlung
with reflector / 100° light beam

GET AUSGLEICHSRAHMEN
GET CORRECTION FRAME

FÜR GET XS FOR GET XS	FARBE COLOUR
468-2115	white

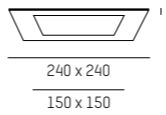

FÜR GET M FOR GET M	FARBE COLOUR
468-2215	white

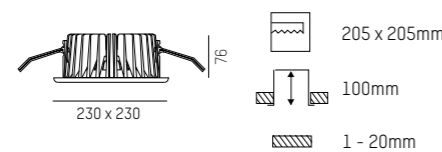
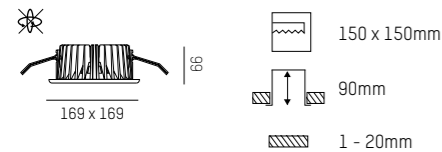
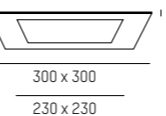

LED CONVERTER	mA	DIMM	FOR
24-127530n	350	not dimmable	1 x GET XS 10W
24-127532n	500	not dimmable	1 x GET XS 15W
24-127534n	700	not dimmable	1 x GET XS 20W / 1 x GET M 21W
24-127536n	900	not dimmable	1 x GET M 27W
24-127538n	1050	not dimmable	1 x GET M 31W
24-127490	350 - 700	DALI dimmable	1 x GET XS 10 - 20W / 1 x GET M 21 - 31W

IP40 / IP44



COMPLETE CODE		
C = COVER	WW = LIGHT COLOUR	XX = COLOUR
opal = 1	LED 3000K = 19 CRI>80	white = 55
microprismatic = 2 UGR<19	LED 4000K = 14 CRI>80	

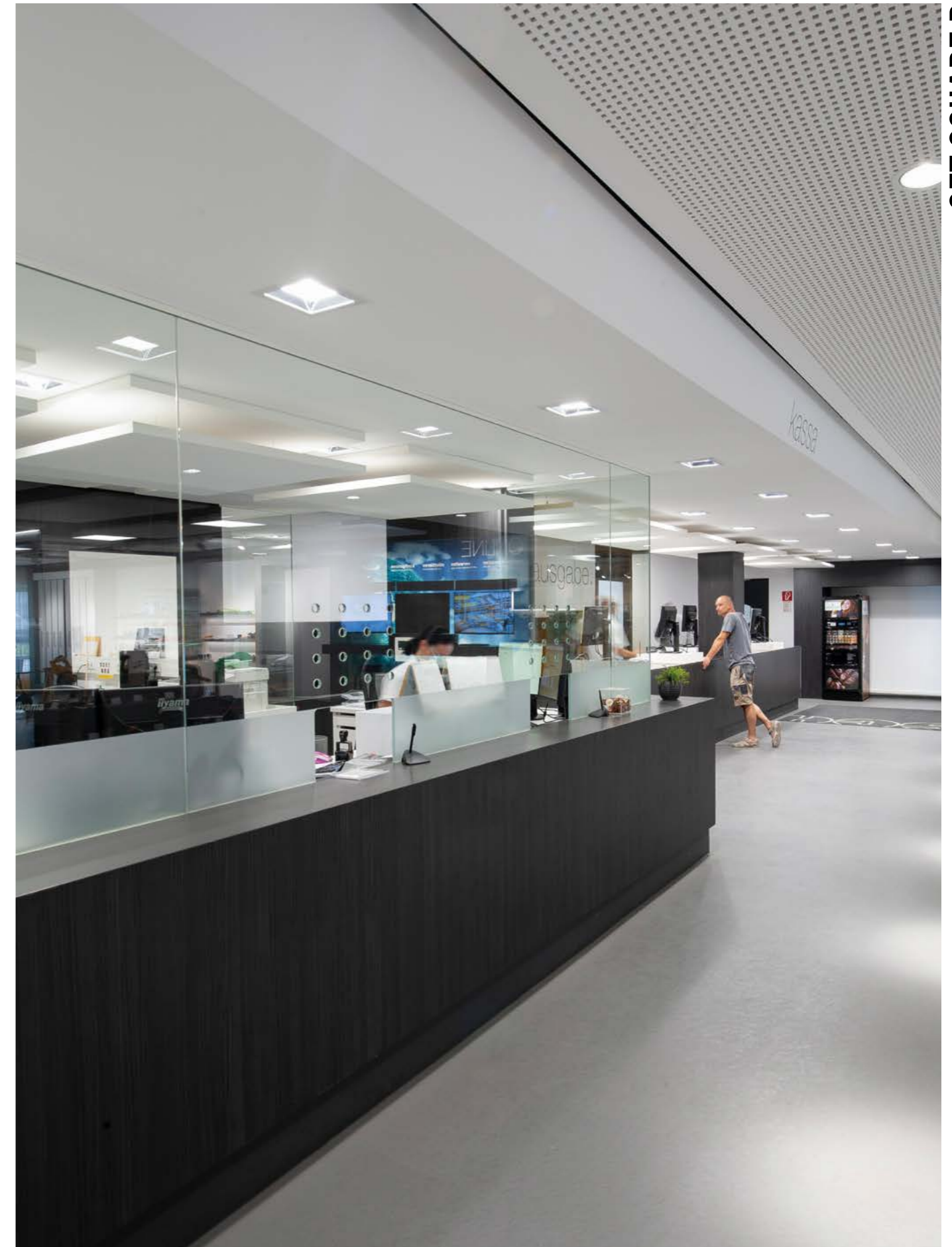

Schachermayer
Vienna, Austria
Photo: Joachim Rauch

Technical data and energy efficiency



GET SQUARE FLAT XS R
331



GET SQUARE FLAT M R



GET SQUARE REFL XS R



GET SQUARE REFL M R

UNIVERSAL BETONEINBAUGEHÄUSE
 UNIVERSAL CONCRETE HOUSING

GEHÄUSE / HOUSING	MATERIAL
332-2001	zinc plated

Einbaugehäuse für Beton ohne Abdeckung, verzinktes Blech, je eine Schlauch-einführung DM 20mm und 25mm links und rechts, Abdeckung separat ordern

Recessed housing for concrete without cover, made of zinc-plated sheet, each tube insertion DM 20mm and 25mm left and right, order cover separately

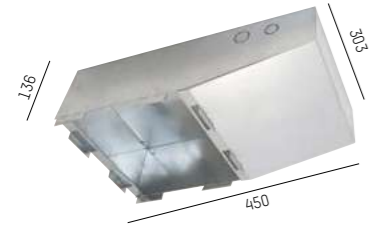
ABDECKUNG RUND / COVER ROUND

ABDECKUNG COVER	AUSSCHNITT CUTOUT	FÜR FOR
332-3r115	Ø 115	ONLY XS R, NOW 2 ROUND R, SAVO 20 S R
332-3r150	Ø 150	ONLY M R, SAVO 20 ROUND R, GET ROUND XS R, DARK NIGHT MEDIUM R
332-3r170	Ø 170	2 G0 R
332-3r205	Ø 205	GET ROUND M R

Abdeckung inkl. Zentrierteil zu Betoneinbaugehäuse 332-2001, verzinktes Blech, nicht für Sichtbeton geeignet

Cover incl. centering for recessed housing for concrete 332-2001, made of zinc-plated sheet, not adapted for exposed concrete

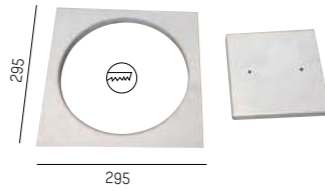
ABDECKUNG QUADRATISCH / COVER SQUARE

ABDECKUNG COVER	AUSSCHNITT CUTOUT	FÜR FOR
332-3q115	115 x 115	NOW 2 SQUARE R
332-3q155	150 x 150	GET SQUARE XS R, SAVO 20 SQUARE R
332-3q205	205 x 205	GET SQUARE M R

Abdeckung inkl. Zentrierteil zu Betoneinbaugehäuse 332-2001, verzinktes Blech, nicht für Sichtbeton geeignet

Cover incl. centering for recessed housing for concrete 332-2001, made of zinc-plated sheet, not adapted for exposed concrete

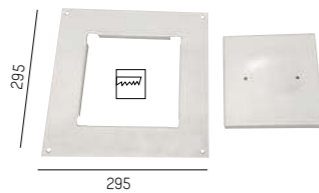
UNIVERSAL BETONEINBAUGEHÄUSE
 UNIVERSAL CONCRETE HOUSING

GEHÄUSE / HOUSING	MATERIAL
332-1001	zinc plated

Einbaugehäuse für Beton ohne Abdeckung, verzinktes Blech, je eine Schlauch-einführung DM 20mm und 25mm links und rechts, Abdeckung separat ordern

Recessed housing for concrete without cover, made of zinc-plated sheet, each tube insertion DM 20mm and 25mm left and right, order cover separately

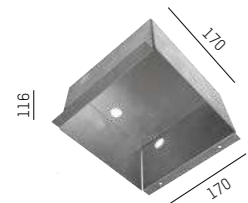
ABDECKUNG RUND / COVER ROUND

ABDECKUNG COVER	AUSSCHNITT CUTOUT	FÜR FOR
332-1402	Ø 80	DARK NIGHT SMALL R

Abdeckung inkl. Zentrierteil zu Betoneinbaugehäuse 332-1001, verzinktes Blech, nicht für Sichtbeton geeignet

Cover incl. centering for recessed housing for concrete 332-1001, made of zinc-plated sheet, not adapted for exposed concrete

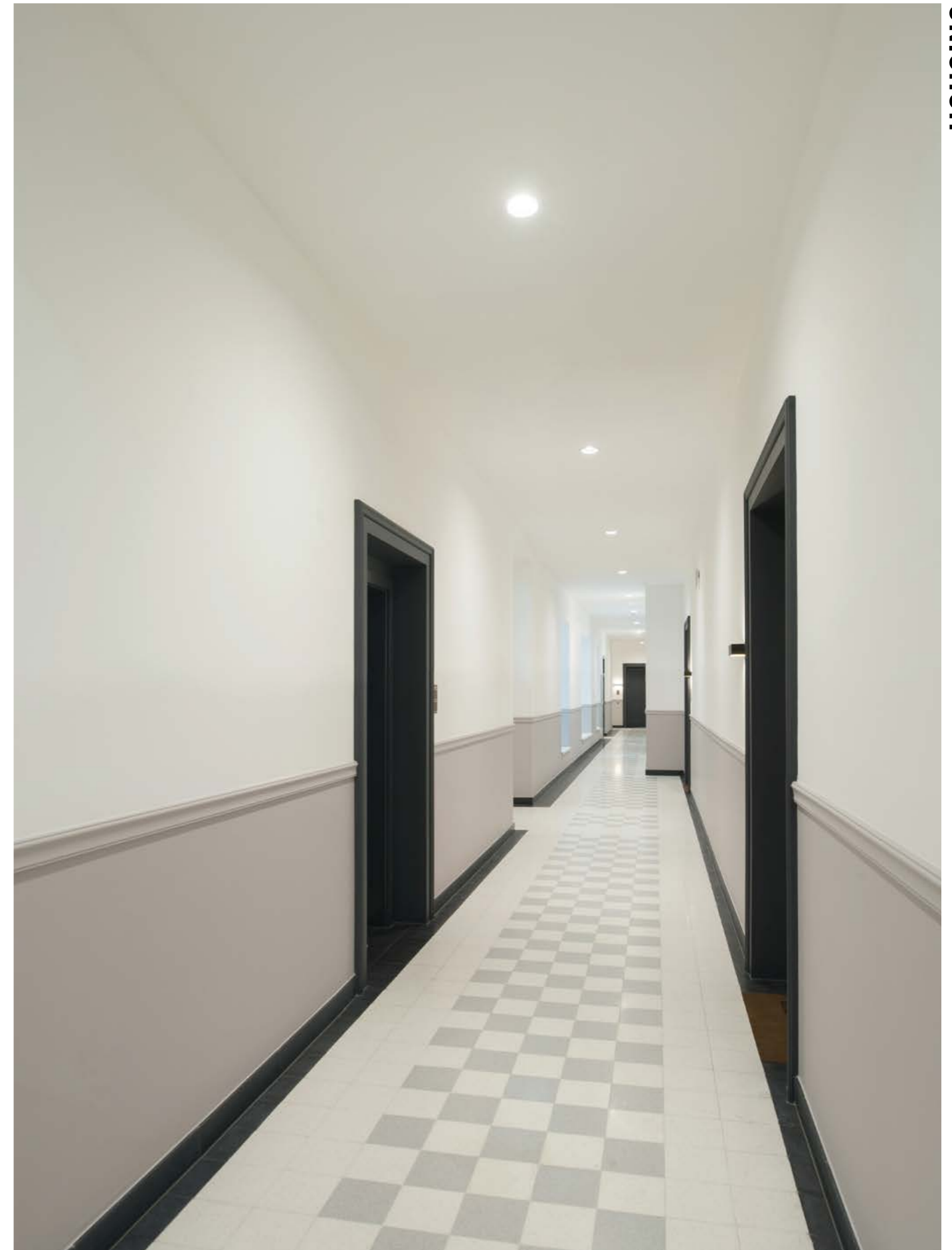
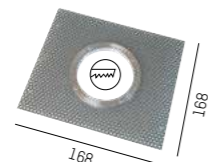



TOUCH DOWN PD

220-240V AC 50/60Hz

Design: INHOUSE

Dekorative Hängeleuchte aus Aluminium · Oberfläche pulverbeschichtet oder lackiert · inkl. 1500mm Abhängung
 Decorative suspension, aluminium · surface powder-coated or painted · PMMA opal diffuser type · included 1500mm cable
 Sospensione decorativa in alluminio · superficie verniciata a polveri o verniciata · Variante con diffusore opale in PMMA · compreso di cavo da 1500mm
 Suspension décorative en tubulaire d'aluminium · surface laquée en poudre ou laquée · Variante avec diffuseur opal en PMMA · 1500mm câble inclus

SYS 25W	LM
692-001010RWWXXYv1	2040 - 2630

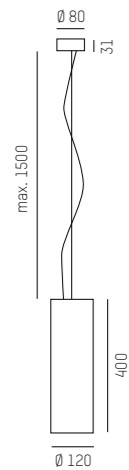

IP20 Ⓢ CE



COMPLETE CODE			
R = BEAM ANGLE	WW = LIGHT COLOUR	XX = COLOUR	Y = DIMMABLE
☐ 24° medium = 5	☐ W2 LED 2700K = 43 PREMIUM CRI>90	☐ chrome = 11	☐ switchable = 0
☐ 60° flood = 9	☐ W3 LED 3000K = 49 PREMIUM CRI>90	☐ white = 55	☐ DALI dimm. = d
	☐ W4 LED 4000K = 24 CRI>90	☐ black = 66	



TOUCH DOWN PD

Private residence
 Austria
 Photo: Joachim Rauch

Technical data and energy efficiency



TOUCH DOWN PD

DECORATIVE



THE SMALLEST 2-PHASE TRACK SYSTEM IN THE WORLD

Die Alternative für Menschen, die das Zarte und das Besondere suchen. Minimalismus und Purismus werden in einer 230V 2-Phasen Schiene mit 18x18mm vereint. Volare ist weltweit das kleinste 2-Phasen-Stromschienensystem. Einfachste Montage der Schienen direkt an Wand oder Decke durch vorgebohrte Löcher oder als abgehängte Versionen mittels Seil oder Stangen. Der neue Adapter besticht nicht nur durch seine kompakte Bauform, sondern ist auch völlig unkompliziert in der Schiene zu fixieren.

The alternative for those who are looking for something delicate and special. Minimalism and purism are united in a 230V two-phase 18x18mm rail. Volare is currently the smallest two-phase power rail system worldwide. Pre-drilled holes make rails extremely simple to fit to walls and ceilings or as pendant versions with cables and rods. The new adaptor is not only impressively small but is also extremely simple to fit into the rail.

VOLARE



Versions

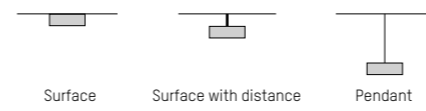

Track 18 x 18mm



Core Colours



Pendants

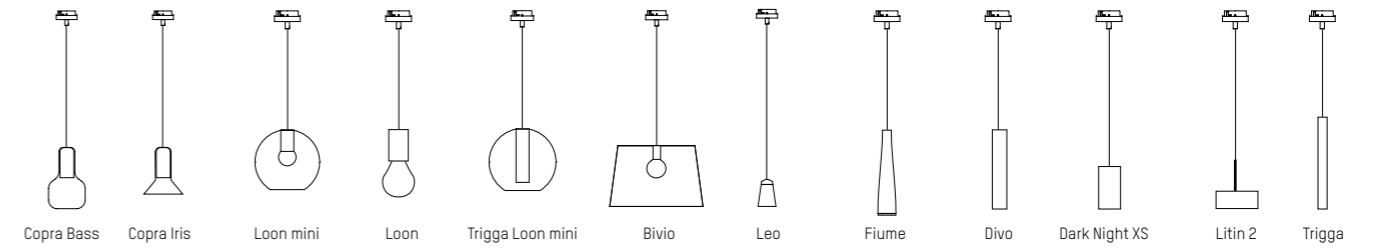

Copra Bass Copra Iris Loon mini Loon Trigga Loon mini Bivio Leo Fiume Divo Dark Night XS Litin 2 Trigga

Spots

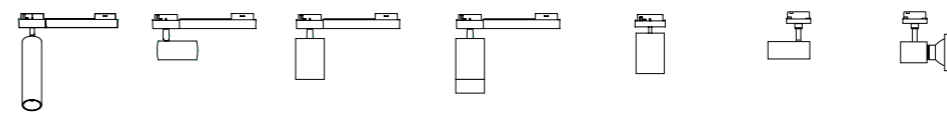

Trigga Vibo Mova S Mova S L Dash 2 Litin 2 Senso

Luminaires

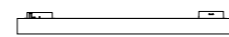

V-Line

Video adapter mounting



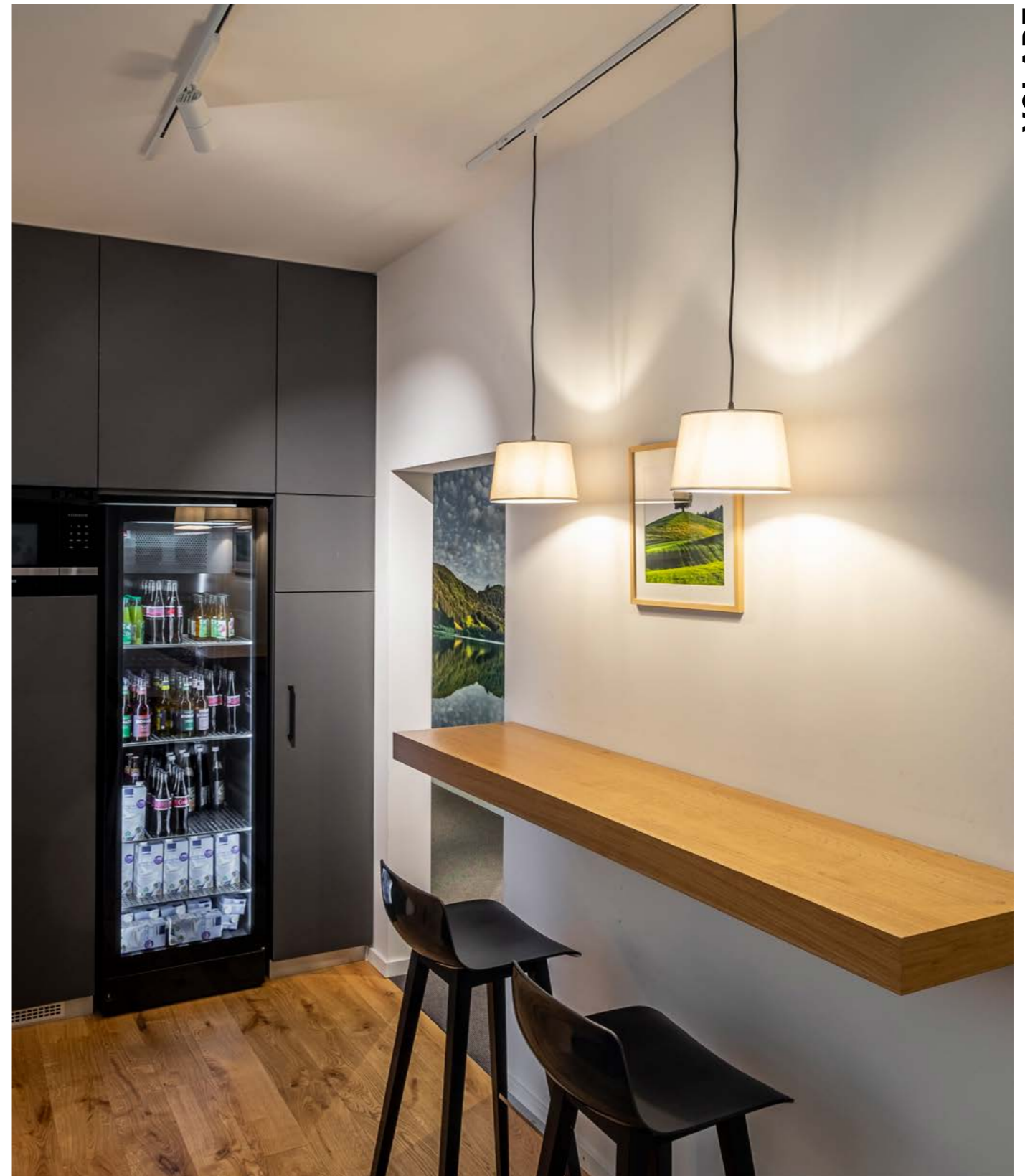

Ideamed GmbH
Munich, Germany
Photo: Alexander Schwarz

CIP Tagesklinik
Munich, Germany
Photo: Alexander Schwarz



Info track & accessoires



TRACK COMPONENTS

220-240V AC 50/60Hz

Design: Doc Form

2-Phasen Stromschiene aus Aluminiumprofil · Oberfläche eloxiert oder lackiert · Installation als Aufbau- und Pendelmontage Systemzubehör separat ordern

2-phase rail made of aluminium · Anodised or painted surface · Surface or suspended mount · Order accessories separately

Binario bifase in alluminio · Anodizzato o verniciato · Montaggio a soffitto/parete o sospensione · Ordinare gli accessori separatamente

Rail à 2 phases en aluminium · Anodisé ou laqué · Montage à plafon/paroi ou suspension · Commander les accessoires séparément

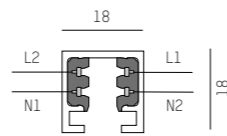

2 - Phase Stromschiene inkl. Bohrungen; 230V max. Belastung: 10A pro Phase beliebig kürzbar

2 - phase circuit track incl. holes; 230V max. load: 10A per phase cut to any length

VOLARE SCHIENE VOLARE TRACK	LÄNGE LENGHT
652-001010000X	1000mm
652-001020000X	2000mm
652-001030000X	2950mm

BLINDABDECKUNG BLIND COVER	LÄNGE LENGHT
652-005010000X	1000mm

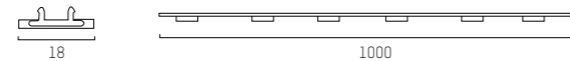
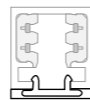

IP20

ENDKAPPE / END PIECE

652-005020000X
Alle Schienen mit einer Endkappe montieren!
All track endings have to be equipped with endpieces!

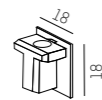

DEMONTAGWERKZEUG / REMOVAL TOOL

652-0000100000
für Volare DC und V-Line Leuchten
for Volare DC and V-Line luminaires

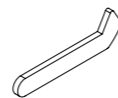

COMPLETE CODE FOR TRACK

X = COLOUR

white = 5 black = 6 alu anodized = 8

VOLARE ADAPTER VOLARE ADAPTER	LÄNGE LENGHT
652-008020000X	71mm



für Pendelleuchten, max. Tragkraft: 5kg
for fixing pendants, max. load 5 kg

COMPLETE CODE FOR ADAPTER

X = COLOUR

grey = 4 white = 5 black = 6

FIXING COMPONENTS

AUFBAUMONTAGE SURFACE MOUNTING	HÖHE HEIGHT
652-002010000X	15mm
652-002020000X	71mm

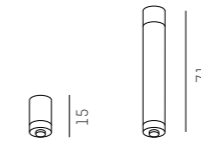

KABELABHÄNGUNG STEEL CABLE SUSPENSION	LÄNGE LENGHT
652-002030000X	1000mm

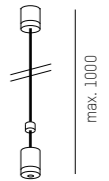

JUNCTION

LINEARVERBINDER LINEAR JUNCTION	LÄNGE LENGHT
652-0030100001	70mm

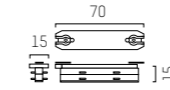

ISOLIERVERBINDER INSULATING JUNCTION	LÄNGE LENGHT
652-0030200001	70mm

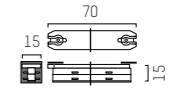

FLEXVERBINDER FLEXIBLE JUNCTION	LÄNGE LENGHT
652-0030300001	110mm

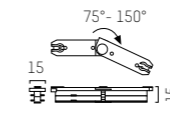

90° VERBINDER 90° JUNCTION	LÄNGE LENGHT
652-003040000X	25mm

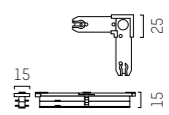

T VERBINDER T-JUNCTION	LÄNGE LENGHT
652-003050000X	130mm

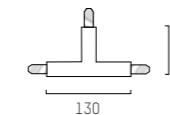

X VERBINDER X-JUNCTION	LÄNGE LENGHT
652-003060000X	130mm

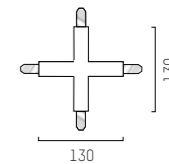

POWER FEED COMPONENTS

ENDEINSPEISUNG END POWER FEED	LÄNGE LENGHT
652-004010000X	180mm

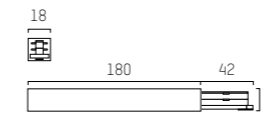

ACHTUNG: Installationsschlauch max. Ø 16mm verwenden
ATTENTION: Use installation conduit with max. Ø 16mm

MITTELEINSPEISUNG CENTER POWER FEED	LÄNGE LENGHT
652-004020000X	300mm



ACHTUNG: Installationsschlauch max. Ø 16mm verwenden
ATTENTION: Use installation conduit with max. Ø 16mm

ENDEINSPEISUNG END POWER FEED	LÄNGE LENGHT
652-004030000X	80mm

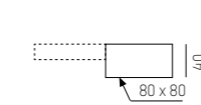

mit Baldachin / with canopy

MITTELEINSPEISUNG CENTER POWER FEED	LÄNGE LENGHT
652-004040000X	80mm

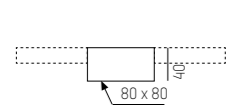

mit Baldachin / with canopy

KABELNDEINSPEISUNG CABLE END POWER FEED	LÄNGE LENGHT
652-004070000X	2000mm

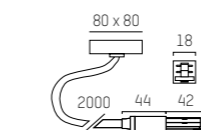

mit Baldachin, beliebig kürzbar, 5 x 1,0mm²
with canopy, cut to any length, 5 x 1,0mm²

KABELNDEINSPEISUNG CABLE END POWER FEED	LÄNGE LENGHT
652-004080000X	2000mm



ohne Baldachin, beliebig kürzbar, 5 x 1,0mm²
without canopy, cut to any length, 5 x 1,0mm²

COMPLETE CODE FOR TRACK

X = COLOUR

white = 5 black = 6 alu anodized = 8

CORPA VOLARE Design: Rainer Mutsch
220-240V AC 50/60Hz QPAR 16 / GU10 / Retrofit max. 9W

Dekorative Hängeleuchte · Oberfläche schwarz pulverbeschichtet · kombinierbar mit 2 verschiedenen mundgeblasenen Gläsern

Decorative pendant lamp · surface black powder-coated · can be combined with 2 different mouth-blown glasses

Lampada decorativa a sospensione · verniciato a polveri in nero · combinabile con due diversi vetri soffiati

Lampe décorative suspendue · vernissé à poudres en noir · combinable avec deux verres soufflés



CORPA IRIS S VOLARE	FARBE	GLAS
CORPA IRIS S VOLARE	COLOUR	GLASS
257-029111X000600	black	champagner
257-029112X000600	black	grey
257-029113X000600	black	rose

CORPA IRIS L VOLARE	FARBE	GLAS
CORPA IRIS S VOLARE	COLOUR	GLASS
257-029121X000600	black	champagner
257-029122X000600	black	grey
257-029123X000600	black	rose

CORPA BASS VOLARE	FARBE	GLAS
CORPA BASS VOLARE	COLOUR	GLASS
257-029131X000600	black	champagner
257-029133X000600	black	grey

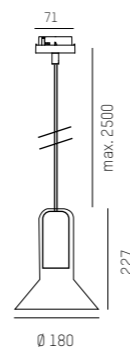
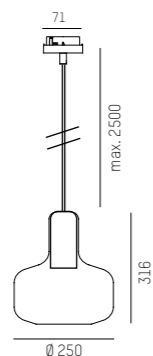
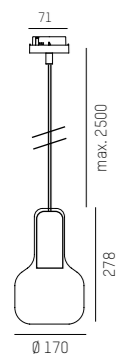

IP20 Leuchtmittel: Siehe Seite: 550 / lamps: look at page 550

COMPLETE CODE FOR ADAPTER		
X = COLOUR		
grey = 4	white = 5	black = 6



For technical data and energy efficiency



CORPA IRIS S VOLARE



CORPA IRIS L VOLARE



CORPA BASS VOLARE



LOON MINI BALL VOLARE Design: INHOUSE
220-240V AC 50/60Hz D45 / E14 / Retrofit max. 4W

Dekorative Hängeleuchte im Retro-Design · hochwertige Glaskugel mundgeblasen in 3 Farben · speziell konstruierte Fassung für bündige Montage

Decorative suspended luminaire in retro design · high-quality blown glass ball in 3 different colours · special socket construction for flush mounting

Sospensione con design decorativo · sfera di vetro soffiato in 3 colori differenti · portalampana speciale per montaggio a filo

Suspension decorative · boule en verre soufflé 3 couleurs au choix · douille de lampe spéciale.

LOON MINI VOLARE	FARBE
LOON MINI VOLARE	COLOUR
636-019000X000600	black

LOON MINI BALL VOLARE	FARBE	GLAS
LOON MINI BALL VOLARE	COLOUR	GLASS
636-019111X000600	black	grey
636-019112X000600	black	amber
636-019113X000600	black	brown

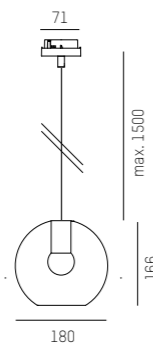
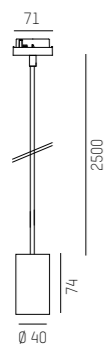

IP20 Leuchtmittel: Siehe Seite: 550 / lamps: look at page 550

COMPLETE CODE FOR ADAPTER		
X = COLOUR		
grey = 4	white = 5	black = 6

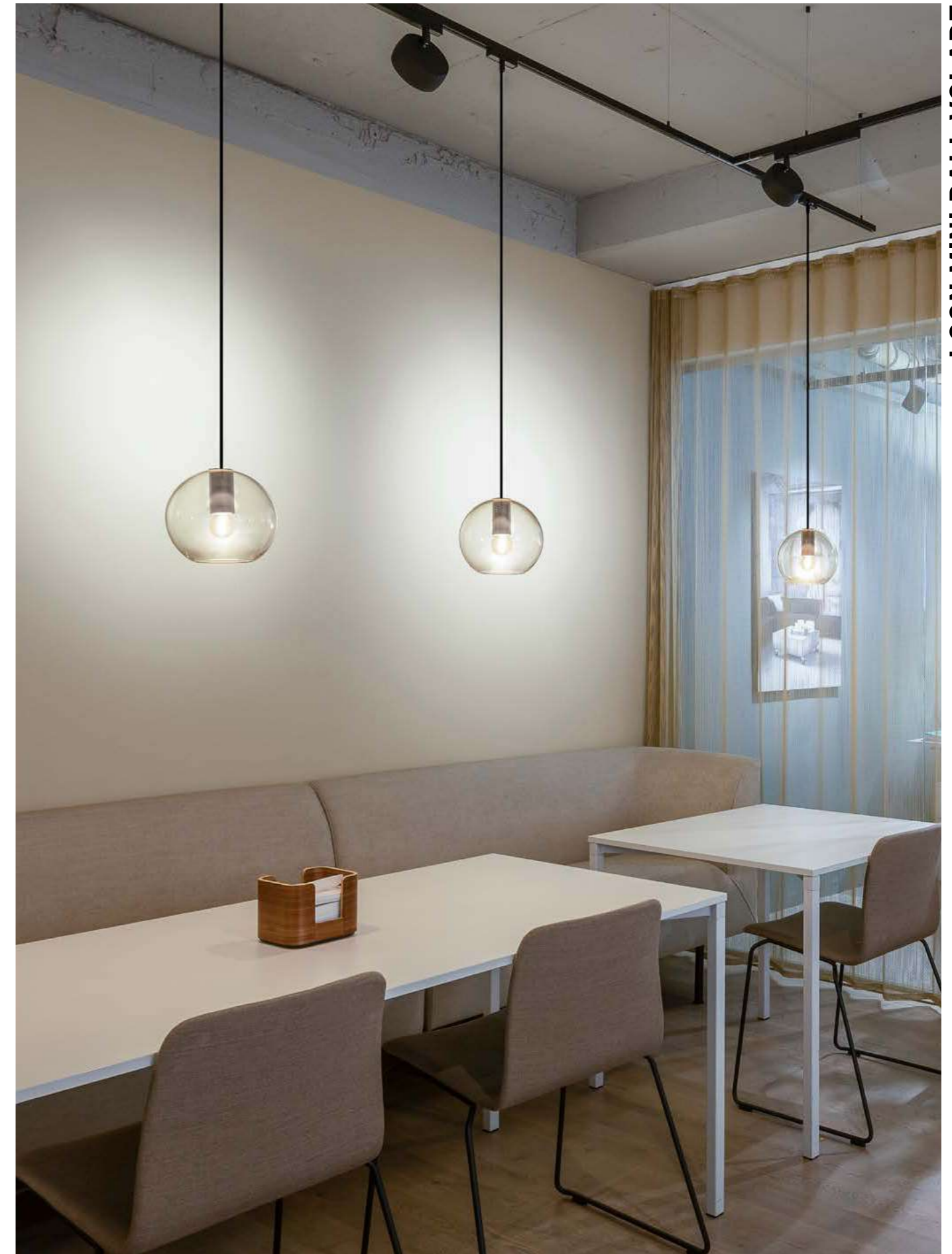

For technical data and energy efficiency



LOON MINI VOLARE



LOON MINI BALL VOLARE

CARDI Showroom
Stockholm, Sweden

LOON VOLARE

Design: INHOUSE

220-240V AC 50/60Hz

Dekorative designreduzierte Hängeleuchte · Hochwertig gearbeitete Lampenfassung aus Aluminium · Inkl. 2500mm Kabel in Schwarz oder Weiß

Decorative design reduced pendant · high quality lamp socket made of aluminium · Incl. 2500mm cable in black or white

Lampada decorativa a sospensione · portalampana di alta qualità in alluminio · cavo da 2500mm in bianco o nero incluso

Lampe décorative suspendue · douille en aluminium de haute qualité · câble noir ou blanc de 2500 mm inclus



LOON VOLARE

636-029000X000X00

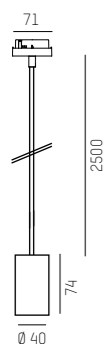

IP20 Ⓢ CE Leuchtmittel: Siehe Seite: 550 / lamps: look at page 550

COMPLETE CODE	
X = COLOUR ADAPTER	X = COLOUR LUMINAIRE
G grey = 4	W white = 5
W white = 5	S black = 6
S black = 6	



LOON VOLARE

For technical data and energy efficiency



LOON VOLARE



TRIGGA LOON MINI VOLARE Design: Serge & Robert Cornelissen
 220-240V AC 50/60Hz UGR<16

LED Pendelleuchte aus Aluminium · Oberfläche schwarz pulverbeschichtet · zurückversetzte Linsen mit verschiedenen Abstrahlwinkeln · Lichtaustrittsfläche von nur 10 mm

LED pendant in aluminium · surface black powder-coated · recessed lenses with different beam-angles · light exit field with only 10 mm

Sospensione a LED in alluminio · superficie verniciata a polveri · Lenti spostati indietro con varie emissioni · dispositivo d'illuminazione di soli 10 mm

Suspension à LED en aluminium · vernissé à poudres en noir · lentes déplacés au fond avec d'émissions différentes · Plus que 10 mm de surface d'émission de lumière

TRIGGA LOON MINI VOLARE

SYS 6W	LM
662-01802RRWWXX0	230 - 290

nicht dimmbar / not dimmable

TRIGGA LOON MINI VOLARE DIMM

SYS 6W	LM
662-01902RRWWXXY	230 - 290

dimmbar / dimmable

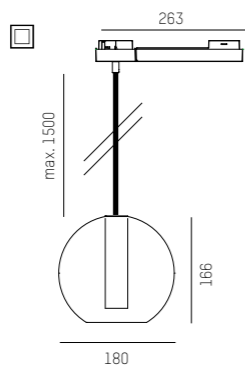
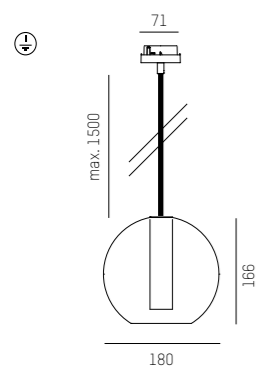

LOXONE Ready

LF0 Lens- Technology by Bartenbach

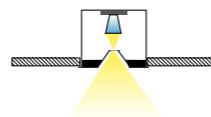

IP20 CE

COMPLETE CODE				
RR = REFLECTOR	WW = LIGHT COLOUR	X = COLOUR ADAPTER	X = COLOUR GLASS	Y = DIMMABLE
☐ 30° medium = 02	☐ W2 LED 2700K = 23 CRI>90	☐ G grey = 4	☐ AM amber = 7	☐ L LOXONE AIR dimm = r
☐ 55° flood = 05	☐ W3 LED 3000K = 29 CRI>90	☐ W white = 5	☐ B brown = 8	☐ B SMART BLUETOOTH dimm = b
		☐ S black = 6	☐ G grey = 9	



TRIGGA LOON MINI VOLARE

For technical data and energy efficiency



TRIGGA LOON MINI VOLARE

TRIGGA LOON MINI VOLARE DIMM

Wiesner & Hager
 Graz, Austria
 Photo: Joachim Rauch



BIVIO VOLARE Design: Michael Raasch
 220-240V AC 50/60Hz A60 ECO / E27 / max. 46W

Dekorative Schirmleuchte · Struktur aus Metal in Schwarz · Stoff schwer entflammbar nach DIN 4102 B1 · Schirm und Pende separat ordern

Decorative shades in different size · metal structure in black · fire resistant fabric according to DIN 4102 B1 · order shade and pendant separately

Paralume decorativo disponibile · struttura metallica in nero · tessuto ignifugo secondo DIN 4102 B1 · paralume e portalamпада da ordinare separatamente

Abat-jour décoratif en tissu proposé · structure métallique noir · tissu ignifugé selon norme DIN 4102 B1 · abat-jour et suspension à commander séparément

BIVIO VOLARE	SCHIRM
BIVIO VOLARE	SHADE
645-107030000X20	grey
645-107030000X30	brown

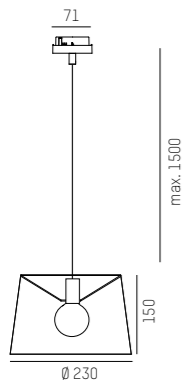

IP20 Leuchtmittel: Siehe Seite: 550 / lamps: look at page 550

COMPLETE CODE FOR ADAPTER

X = COLOUR

grey = 4	white = 5	black = 6
----------	-----------	-----------



For technical data and energy efficiency





LEO 1 / LEO 2 VOLARE

220-240V AC 50/60Hz QPAR 16 / GU10 / Retrofit max. 9W

Hängeleuchte aus Aluminium · Oberfläche pulverbeschichtet · mit oder ohne rauchgrauem satinierten Glas erhältlich · GU10 Fassung

Suspension in black aluminium · surface powder-coated · available with or without smoked grey satin glass · GU10 socket

Sospensione in alluminio nero · superficie verniciata a polvere · disponibile con o senza vetro satinato grigio fumé · portalampada GU10

Suspension en aluminium noir · surface thermolaquée · disponible avec ou sans verre satiné gris fumé · douille GU10

LEO 1 VOLARE	COLOUR
194-01900000000X060	black

ohne Glas / without glass

LEO 2 VOLARE	COLOUR
194-02900000000X060	black

mit Glas rauchgrau / with smoked glass

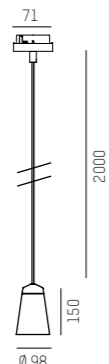
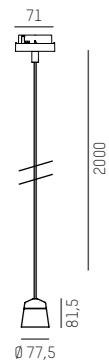

BULB 6,2W CRI>90	COLOUR
30-675414	2700K / 575lm
30-705251	3000K / 575lm



IP20 Ⓢ CE Leuchtmittel: Siehe Seite: 550 / lamps: look at page 550

COMPLETE CODE FOR ADAPTER		
X = COLOUR		
G grey = 4	W white = 5	S black = 6



For technical data and energy efficiency



LEO 1 VOLARE



LEO 2 VOLARE

FIUME VOLARE Design: Rainer Mutsch
220-240V AC 50/60Hz

LED Pendelleuchte aus Gips mit organisch fließender Formgebung · Dezentres Kabel in den Farben der Leuchte Schwarz oder Weiß

LED pendant luminaire made of plaster with organic flowing design · very discreet cable in the colours of the luminaire black or white

Lampada LED a sospensione in gesso dalla forma organica in movimento · cavo molto discreto disponibile in bianco o nero

Lampe LED suspendue en plâtre avec une forme organique en mouvement · câble très discret disponible en noir ou en blanc

SYS 6W	LM
184-209000002WXY	280

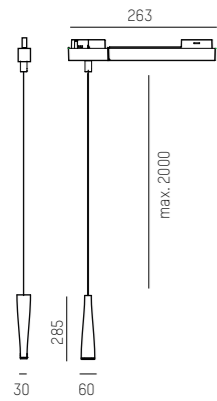

LOXONE Ready

IP20

COMPLETE CODE			
W = LIGHT COLOUR	X = COLOUR LUMINAIRE	X = COLOUR ADAPTER	Y = DIMMABLE
LED 2700K = 3 CRI>90	white = 5	grey = 4	switchable = 0
LED 3000K = 9 CRI>90	black = 6	white = 5	LOXONE AIR dimm = r
		black = 6	SMART BLUETOOTH dimm = b

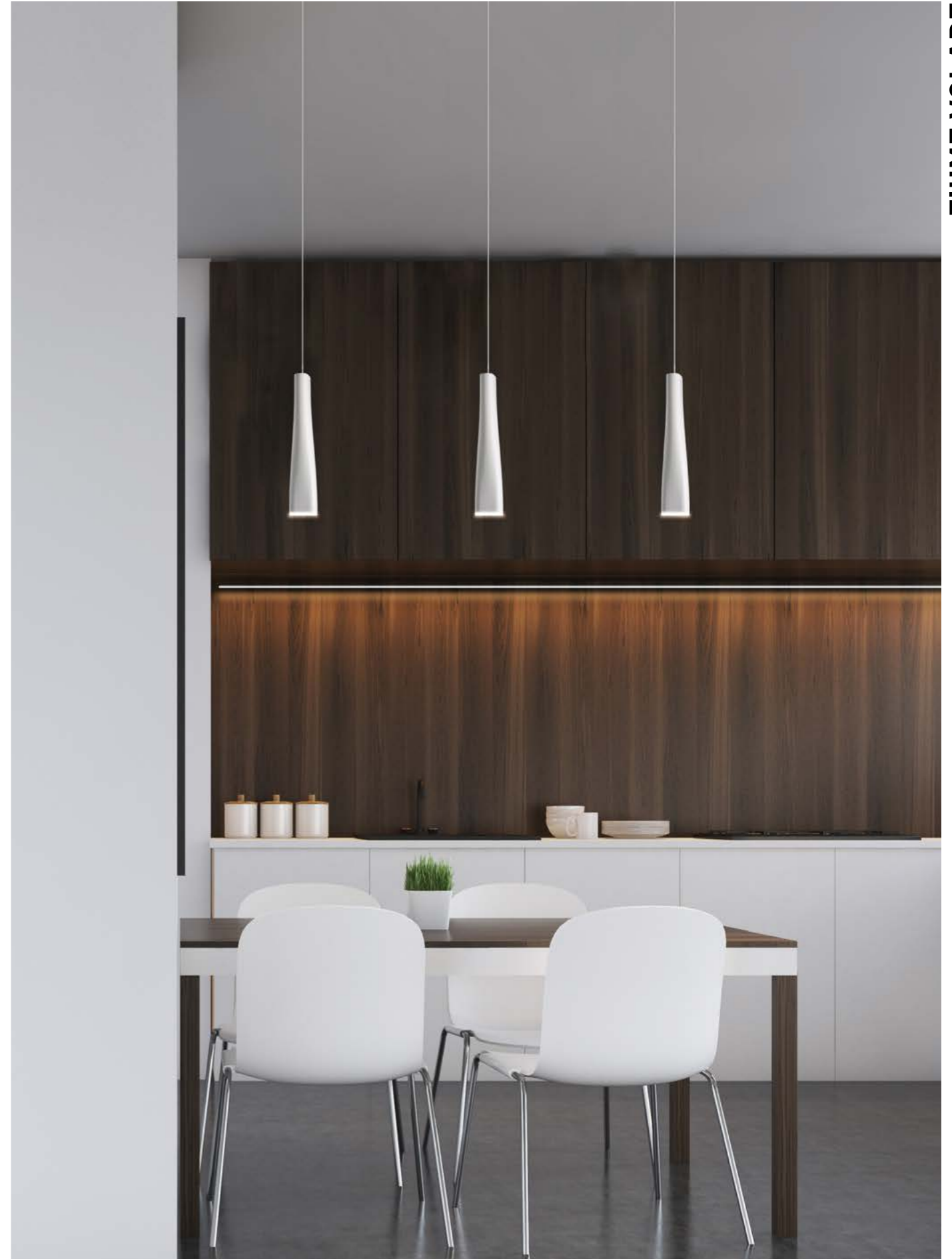

For technical data and energy efficiency



DIVO VOLARE

220-240V AC 50/60Hz

Zylindrische LED Pendelleuchte · Leuchtenkörper erhältlich in zwei Längen · Oberfläche pulverbeschichtet · Ausstrahlwinkel 36°

Cylindrical LED pendant luminaire · lamp body available in two lengths · surface powder-coated · beam angle 36°

Lampada LED a sospensione di forma cilindrica · corpo lampada disponibile in due lunghezze · superficie verniciata a polveri · fascio d'apertura 36°

Lampe suspendue cylindrique à LED · corps de lampe disponible en deux longueurs · vernissé à poudres · faisceau d'ouverture 36°



DIVO SHORT VOLARE

SYS 12W	LM
192-209020002WXXY	680

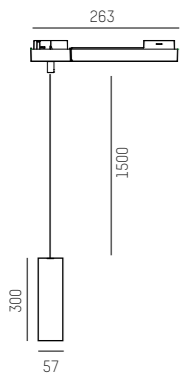

LOXONE Ready

DIVO LONG VOLARE

SYS 12W	LM
192-209030002WXXY	680

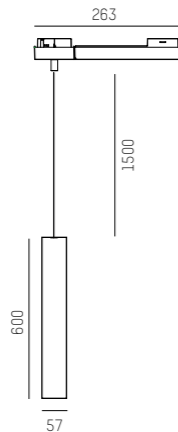

LOXONE Ready

IP20

COMPLETE CODE			
W = LIGHT COLOUR	X = COLOUR LUMINAIRE	X = COLOUR ADAPTER	Y = DIMMABLE
LED 2700K = 3 CRI>90	white = 5	grey = 4	switchable = 0
LED 3000K = 9 CRI>90	black = 6	white = 5	LOXONE AIR dimm = r
		black = 6	SMART BLUETOOTH dimm = b

360



DIVO VOLARE

For technical data and energy efficiency



DIVO SHORT VOLARE



DIVO LONG VOLARE

361

BACK TO CONTENT



DARK NIGHT XS VOLARE

Design: INHOUSE

220-240V AC 50/60Hz UGR<19

LED Pendelleuchte aus Aluminium · Oberfläche pulverbeschichtet · Reflektor in 4 Farben erhältlich · inkl. 3000mm Abhängung

LED pendant in aluminium · surface powder-coated · reflector available in 4 colours · incl. 3000mmm suspension

Sospensione LED in alluminio · verniciato a polvere in bianco o nero · Riflettore disponibile in 4 colori. Incl. 3000mm di sospensione

Lampe suspensue LED en aluminium · vernissé à poudres · réflecteur disponible en 4 couleurs · avec 3000mm de suspension

SYS 17W	LM
684-007RR05WWXXY	1160 - 1290

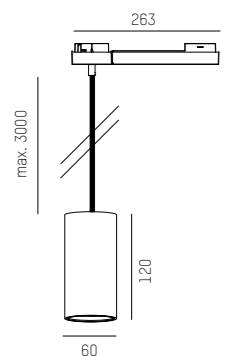

LOXONE Ready

IP20

COMPLETE CODE				
RR = REFLECTOR	WW = LIGHT COLOUR	X = COLOUR ADAPTER	X = COLOUR LUMINAIRE	Y = DIMMABLE
40° medium = 02	LED 2700K = 43 PREMIUM CRI>90	grey = 4	white = 5	switchable = 0
40° medium = 03	LED 3000K = 49 PREMIUM CRI>90	white = 5	black = 6	LOXONE AIR dimm = r
40° medium = 04	LED 4000K = 24 CRI>90	black = 6		SMART BLUETOOTH dimm = b
40° medium = 06				



DARK NIGHT XS VOLARE

For technical data and energy efficiency



DARK NIGHT XS VOLARE

TRIGGA VOLARE Design: Serge & Robert Cornelissen
 220-240V AC 50/60Hz UGR<16

LED Pendelleuchte aus Aluminium · Oberfläche pulverbeschichtet · zurückversetzte Linsen mit verschiedenen Abstrahlwinkeln

LED pendant in aluminium · surface powder-coated · recessed lenses with different beam-angles

Sospensione a LED in alluminio · superficie verniciata a polveri · lenti spostati indietro con varie emissioni

Suspension á LED en aluminium · surface laquée en poudre · lentilles déplacés au fond avec d'émissions différentes

TRIGGA SHORT VOLARE

SYS 6W / H: 140mm	LM
662-00202RRWWXX0	230 - 290

nicht dimmbar / not dimmable

TRIGGA SHORT VOLARE DIMM

SYS 6W / H: 140mm	LM
662-01502RRWWXXY	230 - 290

dimmbar / dimmable

TRIGGA LONG VOLARE

SYS 6W / H: 280mm	LM
662-00302RRWWXX0	230 - 290

nicht dimmbar / not dimmable

TRIGGA LONG VOLARE DIMM

SYS 6W / H: 280mm	LM
662-01602RRWWXXY	230 - 290

dimmbar / dimmable

TRIGGA XL VOLARE

SYS 6W / H: 420mm	LM
662-02002RRWWXX0	230 - 290

nicht dimmbar / not dimmable

TRIGGA XL VOLARE DIMM

SYS 6W / H: 420mm	LM
662-02202RRWWXXY	230 - 290

dimmbar / dimmable

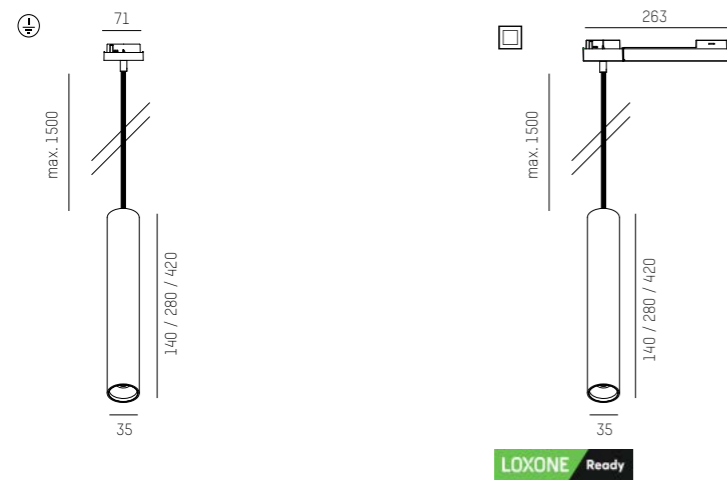

LFO Lens- Technology by Bartenbach

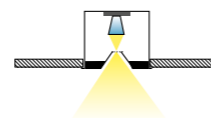

IP20 CE

COMPLETE CODE				
RR = REFLECTOR	WW = LIGHT COLOUR	X = COLOUR ADAPTER	X = COLOUR LUMINAIRE	Y = DIMMABLE
<ul style="list-style-type: none"> 30° medium = 02 55° flood = 05 	<ul style="list-style-type: none"> W2 LED 2700K = 23 CRI>90 W3 LED 3000K = 29 CRI>90 	<ul style="list-style-type: none"> G grey = 4 W white = 5 S black = 6 	<ul style="list-style-type: none"> W white = 5 S black = 6 B bronze = 8 	<ul style="list-style-type: none"> L LOXONE AIR dimm = r B SMART BLUETOOTH dimm = b



TRIGGA VOLARE

For technical data and energy efficiency

TRIGGA SHORT VOLARE	TRIGGA SHORT VOLARE DIMM	TRIGGA LONG VOLARE	TRIGGA LONG VOLARE DIMM	TRIGGA XL VOLARE	TRIGGA XL VOLARE DIMM



LITIN 2 PD VOLARE Design: INHOUSE

220-240V AC 50/60Hz CRI>90

LED Pendelleuchte aus Aluminium · Oberfläche pulverbeschichtet · mit satinierem bündigem Diffusor aus PMMA oder mit Linsenoptik erhältlich · Gehäuse und Dekorring in unterschiedlichen Farben

LED pendant in aluminium · surface powder-coated surface · available with satined flush PMMA diffuser or with lens optics · housing and decorative ring in different colours

Sospensione LED in alluminio · superficie verniciata a polvere · disponibile con diffusore a filo satinato in PMMA o con lente · corpo ed anello decorativo in diversi colori

Suspension LED en aluminium · surface thermolaquée · disponible avec un diffuseur affleurant satiné en PMMA ou avec une technologie de lentille · corps et anneau décoratif disponibles en différentes couleurs

SYS 10W LM
540-021RRWWDDXXX0 530 - 840

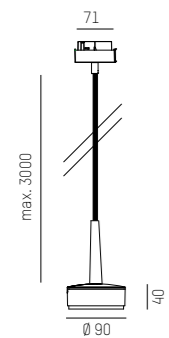

IP20



COMPLETE CODE				
RR = REFLECTOR	WW = LIGHT COLOUR	DD = DECORRING COLOUR	X = COLOUR ADAPTER	XX = COLOUR LUMINAIRE
opal diffusor = 10	LED 2700K = 13 CRI>90	white = 05	grey = 4	white = 05
24° medium lens = 22	LED 3000K = 19 CRI>90	black = 06	white = 5	black = 06
40° flood lens = 23	LED 4000K = 14 CRI>90	gold = 1d	black = 6	
		copper = 1b		



LITIN 2 PD VOLARE

For technical data and energy efficiency



LITIN 2 PD VOLARE

Molto Luce
Munich, Germany
Photo: Joachim Rauch



TRIGGA SPOT VOLARE Design: Serge & Robert Cornelissen
 220-240V AC 50/60Hz UGR<16

LED Schienenstrahler aus Aluminium · Oberfläche pulverbeschichtet · zurückversetzte Linsen mit verschiedenen Abstrahlwinkeln · Lichtaustrittsfläche von nur 10 mm

LED track spot in aluminium · surface powder-coated · recessed lenses with different beam-angles · light exit field with only 10 mm

Proiettore LED per binario in alluminio · verniciatura a polveri · lenti spostate indietro con varie emissioni · dispositivo d'illuminazione di soli 10 mm

Projecteur à LED en aluminium · vernissage à poudre · lentes déplacées au fond avec d'émissions différentes · plus que 10 mm de surface d'émission de lumière

TRIGGA SPOT VOLARE

SYS 6W	LM
662-00102RRWWXX0	230 - 290

nicht dimmbar / not dimmable

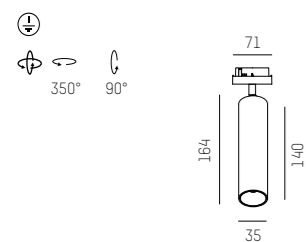

TRIGGA SPOT VOLARE DIMM

SYS 11W	LM
662-01402RRWWXXY	380 - 470

dimmbar / dimmable

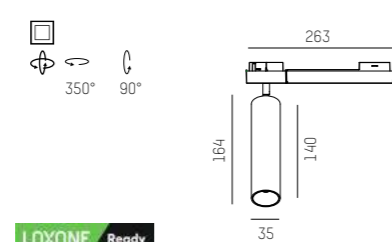

LFO Lens- Technology by Bartenbach

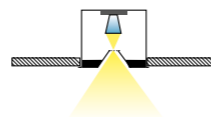

IP20 CE



COMPLETE CODE				
RR = REFLECTOR	WW = LIGHT COLOUR	X = COLOUR ADAPTER	X = COLOUR LUMINAIRE	Y = DIMMABLE
<ul style="list-style-type: none"> 30° medium = 02 55° flood = 05 	<ul style="list-style-type: none"> W2 LED 2700K = 23 CRI>90 W3 LED 3000K = 29 CRI>90 	<ul style="list-style-type: none"> G grey = 4 W white = 5 S black = 6 	<ul style="list-style-type: none"> W white = 5 S black = 6 	<ul style="list-style-type: none"> L LOXONE AIR dimm = r B SMART BLUETOOTH dimm = b

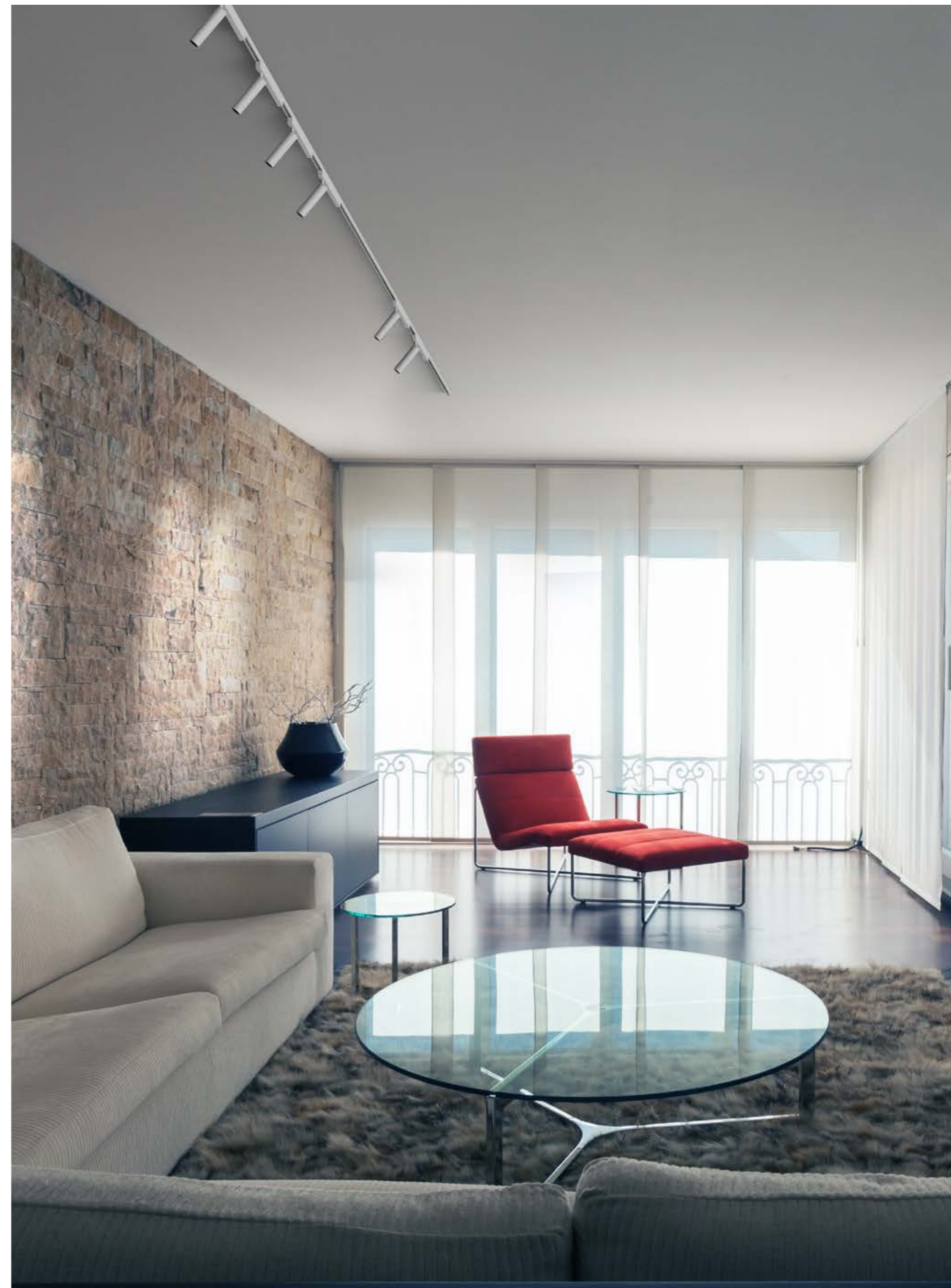

TRIGGA SPOT VOLARE

For technical data and energy efficiency



TRIGGA SPOT VOLARE

TRIGGA SPOT VOLARE DIMM



VIBO VOLARE Design: INHOUSE

220-240V AC 50/60Hz UGR<16

Schiensstrahler aus Aluminium · Oberfläche pulverbeschichtet · Spezielle Linsenoptik ohne Streulicht · Dekoring in Weiß oder Schwarz pulverbeschichtet

Track spotlight in aluminium · surface powder-coated · Special lens optics without scattered light · decoration ring black or white powder-coated

Faretto da binario in alluminio · verniciatura a polvere · Ottica speciale senza luce diffusa · anello decorativo verniciato a polvere in nero o bianco

Projecteur sur rail en aluminium · vernissage à poudre · lentille optique sans lumière parasite · anneau décoratif laqué noir ou blanc

VIBO VOLARE

SYS 8W	LM
668-00401RRWWXX0	340 - 470

nicht dimmbar / not dimmable

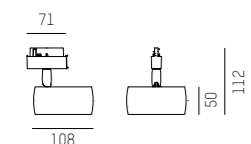

VIBO VOLARE DIMM

SYS 8W	LM
668-00501RRWWXXY	340 - 470

dimmbar / dimmable

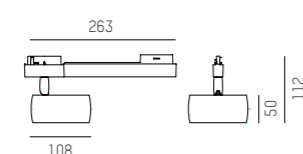

LOXONE Ready

DEKORRING für 2 farbige Versionen
DECOR RING for bi-coloured versions

DEKORRING	FARBE
668-000105	white
668-000106	black



IP20 CE

COMPLETE CODE				
RR = REFLECTOR	WW = LIGHT COLOUR	X = COLOUR ADAPTER	X = COLOUR LUMINAIRE	Y = DIMMABLE
<ul style="list-style-type: none"> ☐ 10° spot = 02 ☐ 23° medium = 05 ☐ 35° flood = 08 	<ul style="list-style-type: none"> W2 LED 2700K = 23 CRI>90 W3 LED 3000K = 29 CRI>90 W4 LED 4000K = 24 CRI>90 	<ul style="list-style-type: none"> G grey = 4 W white = 5 S black = 6 	<ul style="list-style-type: none"> W white = 5 S black = 6 	<ul style="list-style-type: none"> Ⓐ LOXONE AIR dimm = r Ⓑ SMART BLUETOOTH dimm = b Ⓒ ZIGBEE dimm = z



VIBO VOLARE

Wohnfonds MSG
Vienna, Austria
Photo: Gabriel Büchelmeier

For technical data and energy efficiency



VIBO VOLARE



VIBO VOLARE DIMM



DASH 2 VOLARE Design: INHOUSE

220-240V AC 50/60Hz UGR<19

Schienenstrahler aus Aluminium - Oberfläche pulverbeschichtet - Strahler 350° dreh-, 90° schwenkbar

Track spotlight made of aluminium - powder-coated surface - Spotlight 350° rotatable, 90° swivelling

Proiettore da binario in alluminio - Superficie verniciata a polveri - Testa girevole 350°, orientabile 90°

Projecteur sur rail en aluminium - Surface revêtue de poudre - Tête orientable à 350°, pivotante à 90°

SYS 10W	LM
599-103010RWWXX0	500-590

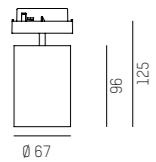

IP20



COMPLRTE CODE	WW = LIGHT COLOUR	XX = COLOUR
R = BEAM ANGLE	W2 LED 2700K = 23 CRI>90	6 grey = 04
spot 17° = 2	W3 LED 3000K = 29 CRI>90	W white = 05
medium 24° = 3	W4 LED 4000K = 24 CRI>90	S black = 06
flood 40° = 4		



DASH 2 VOLARE

For technical data and energy efficiency



DASH 2 VOLARE



LITIN 2 VOLARE Design: INHOUSE
 220-240V AC 50/60Hz CRI>90

LED Stromschienenstrahler aus Aluminium · Oberfläche pulverbeschichtet · mit satinierem bündigem Diffusor aus PMMA oder mit Linsenoptik erhältlich · Gehäuse und Dekorring in unterschiedlichen Farben

LED track spotlight in aluminium · surface powder-coated surface · available with satinied flush PMMA diffuser or with lens optics · housing and decorative ring in different colours

Proiettore LED da binario in alluminio · superficie verniciata a polvere · disponibile con diffusore a filo satinato in PMMA o con lente · corpo ed anello decorativo in diversi colori

Spot LED pour rail en aluminium · surface thermolaquée · disponible avec un diffuseur affleurant satiné en PMMA ou avec une technologie de lentille · corps et anneau décoratif disponibles en différentes couleurs

SYS 10W LM
 540-051RRWWDDXXO 530 - 840

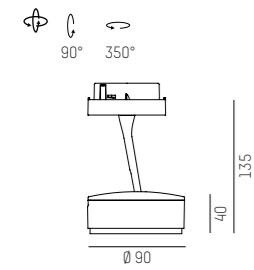

IP20 CE



COMPLETE CODE				
RR = REFLECTOR	WW = LIGHT COLOUR	DD = DECORRING COLOUR	X = COLOUR ADAPTER	XX = COLOUR LUMINAIRE
☐ opal diffusor = 10	W2 LED 2700K = 13 CRI>90	W white = 05	G grey = 4	W white = 05
☐ 24° medium lens = 22	W3 LED 3000K = 19 CRI>90	S black = 06	W white = 5	S black = 06
☐ 40° flood lens = 23	W4 LED 4000K = 14 CRI>90	B gold = 1d	S black = 6	
		K copper = 1b		



LITIN 2 VOLARE

For technical data and energy efficiency



LITIN 2 VOLARE

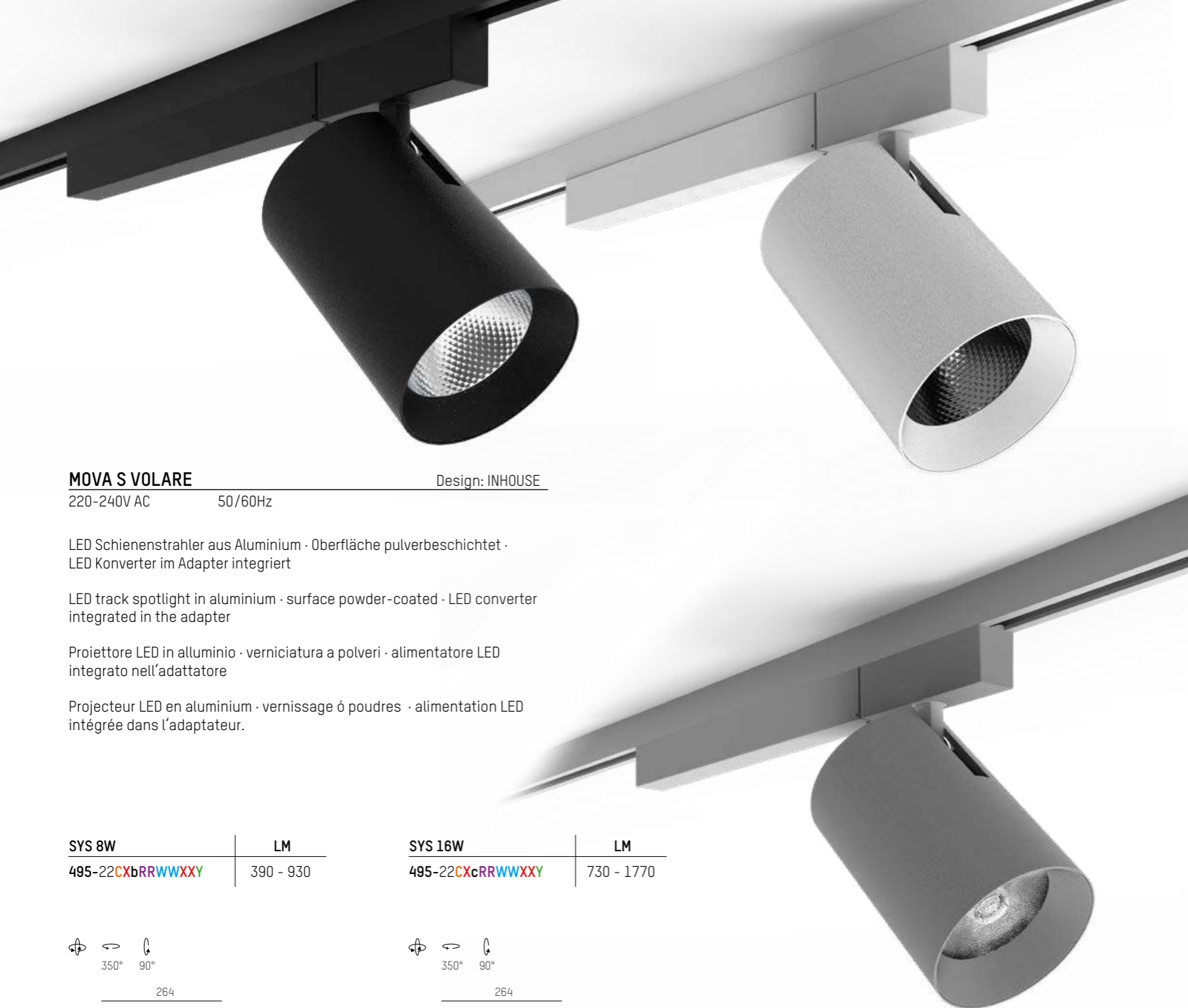

MOVA S VOLARE Design: INHOUSE
220-240V AC 50/60Hz

LED Schienenstrahler aus Aluminium · Oberfläche pulverbeschichtet · LED Konverter im Adapter integriert

LED track spotlight in aluminium · surface powder-coated · LED converter integrated in the adapter

Proiettore LED in alluminio · verniciatura a polveri · alimentatore LED integrato nell'adattatore

Projecteur LED en aluminium · vernissage à poudres · alimentation LED intégrée dans l'adaptateur.

SYS 8W	LM	SYS 16W	LM
495-22 CXbRR WWXXY	390 - 930	495-22 CXcRR WWXXY	730 - 1770



LOXONE Ready

IP20

COMPLETE CODE				
C = COVER	RR = REFLECTOR	WW = LIGHT COLOUR	X.....XX = COLOUR	Y = DIMMABLE
without glass = 0 (for lens order 0)	17° chrome = 12 24° chrome = 13 40° chrome = 14	W2 LED 2700K = 43 PREM CRI>90 W3 LED 3000K = 49 PREM CRI>90 W4 LED 4000K = 24 CRI>90	g grey = 4.....44 w white = 5.....55 s black = 6.....66	Ⓢ switchable = 0 Ⓛ LOXONE AIR dimm = r Ⓟ SMART BLUETOOTH dimm = b
with glass = 1 (not for lens)	17° dark chrome = 62 24° dark chrome = 63 40° dark chrome = 64 10° lens = 31 17° lens = 32 24° lens = 33 40° lens = 34			

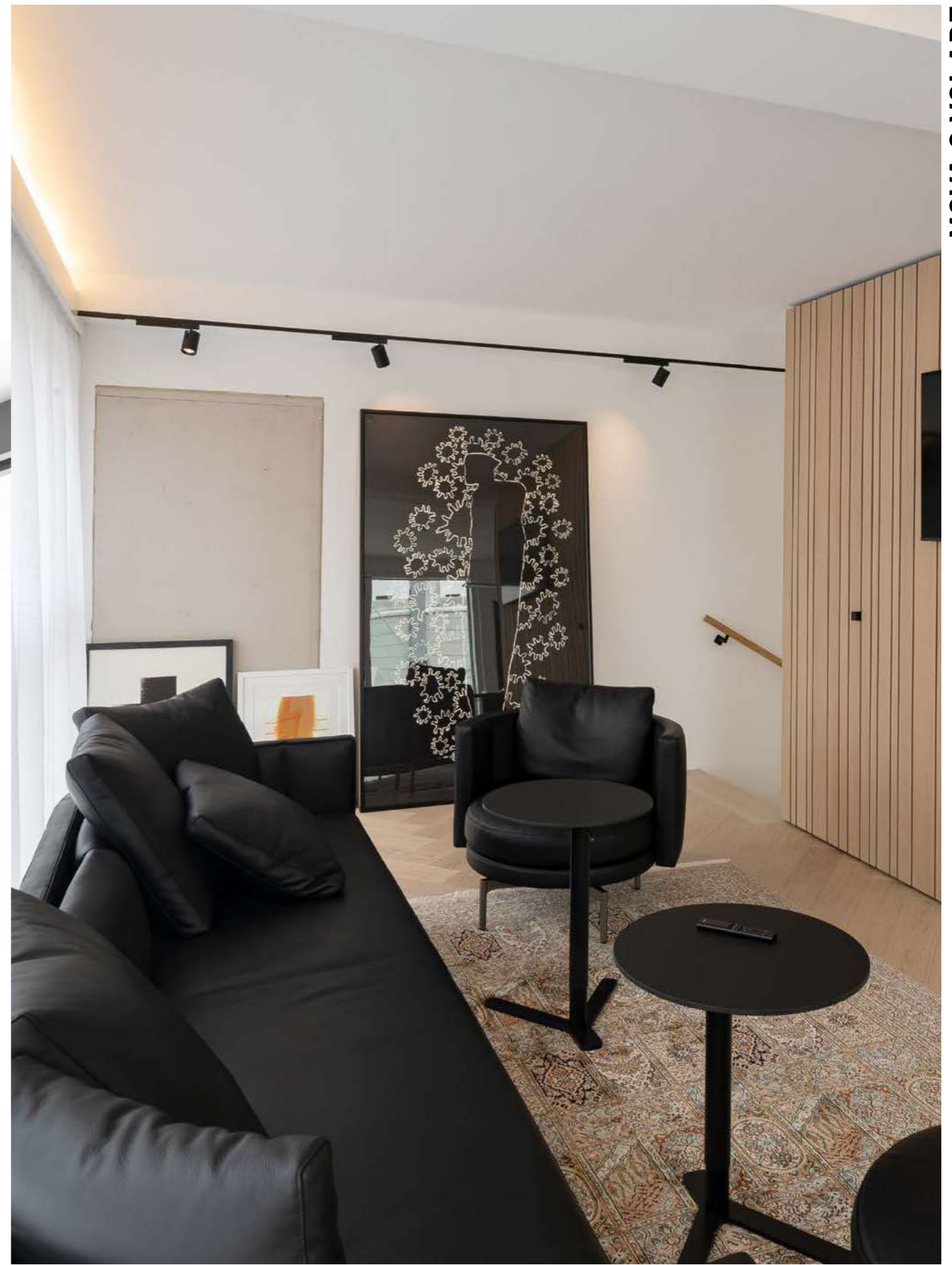

For technical data and energy efficiency



Carpe Diem
Linz, Austria
Photo: Joachim Rauch



MOVA S L VOLARE Design: INHOUSE
220-240V AC 50/60Hz

LED Schienenstrahler aus Aluminium · Oberfläche pulverbeschichtet · LED Konverter im Adapter integriert
LED track spotlight in aluminium · surface powder-coated · LED converter integrated in the adapter
Proiettore LED in alluminio · verniciatura a polveri · alimentatore LED integrato nell'adattatore
Projecteur LED en aluminium · vernissage ó poudres · alimentation LED intégrée dans l'adaptateur.

With golden decoration ring:
MOVA Configurator: www.moltoluce.com

WITH CHROME OR DARK CHROME REFLECTOR

SYS 8W	LM
495-26C XbRR WWXXY	180 - 430

WITH CHROME OR DARK CHROME REFLECTOR

SYS 16W	LM
495-26C XcRR WWXXY	340 - 820

WITH GLASS LENS

SYS 8W	LM
495-270 XbRR WWXXY	590 - 730

WITH GLASS LENS

SYS 16W	LM
495-270 XcRR WWXXY	1120 - 1370

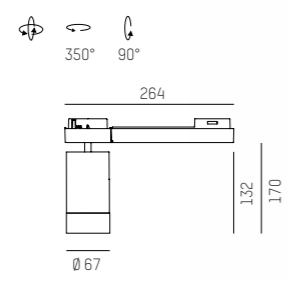
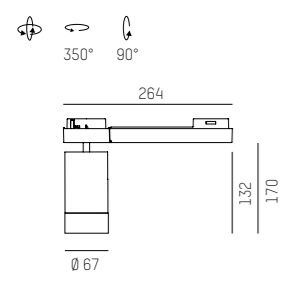

LOXONE Ready

LOXONE Ready

IP20

COMPLETE CODE				
C = COVER	RR = REFLECTOR	WW = LIGHT COLOUR	X.....XX = COLOUR	Y = DIMMABLE
without glass = 0 (for lens order 0)	<ul style="list-style-type: none"> 17° chrome = 12 24° chrome = 13 40° chrome = 14 	<ul style="list-style-type: none"> W2 LED 2700K = 43 PREM CRI>90 W3 LED 3000K = 49 PREM CRI>90 W4 LED 4000K = 24 CRI>90 	<ul style="list-style-type: none"> grey = 4.....44 white = 5.....55 black = 6.....66 	<ul style="list-style-type: none"> switchable = 0 LOXONE AIR dimm = r SMART BLUETOOTH dimm = b
with glass = 1 (not for lens)	<ul style="list-style-type: none"> 17° dark chrome = 62 24° dark chrome = 63 40° dark chrome = 64 10° lens = 31 17° lens = 32 24° lens = 33 40° lens = 34 			



MOVA S L VOLARE

For technical data and energy efficiency



Made Köck
Kirchberg am Wechsel, Austria
Photo: Joachim Rauch

MOVA S L VOLARE

MOVA S GU10 VOLARE

Design: INHOUSE

220-240V AC 50/60Hz QPAR 16 / GU10 / Retrofit max. 9W

LED Schienenstrahler aus Aluminium · Oberfläche pulverbeschichtet ·
Passend für LED Retrofit QPAR 16 · exkl. Leuchtmittel

LED track spotlight made of aluminium · surface powder-coated · suitable
for LED Retrofit QPAR 16 · Without lamps

Proiettore LED in alluminio · verniciatura a polveri · compatibile con lampadine
LED Retrofit QPAR16 · Lampadine escluse

Projecteur LED en aluminium moulé sous pression · vernissage à poudres ·
compatible avec les ampoules LED QPAR16 Retrofit · sans ampoules

MOVA S GU 10 VOLARE

495-42000000XX0

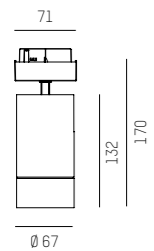

IP20 Leuchtmittel: Siehe Seite: 550 / lamps: look at page 550

COMPLETE CODE

XX = COLOUR

grey = 44

white = 55

black = 66

380

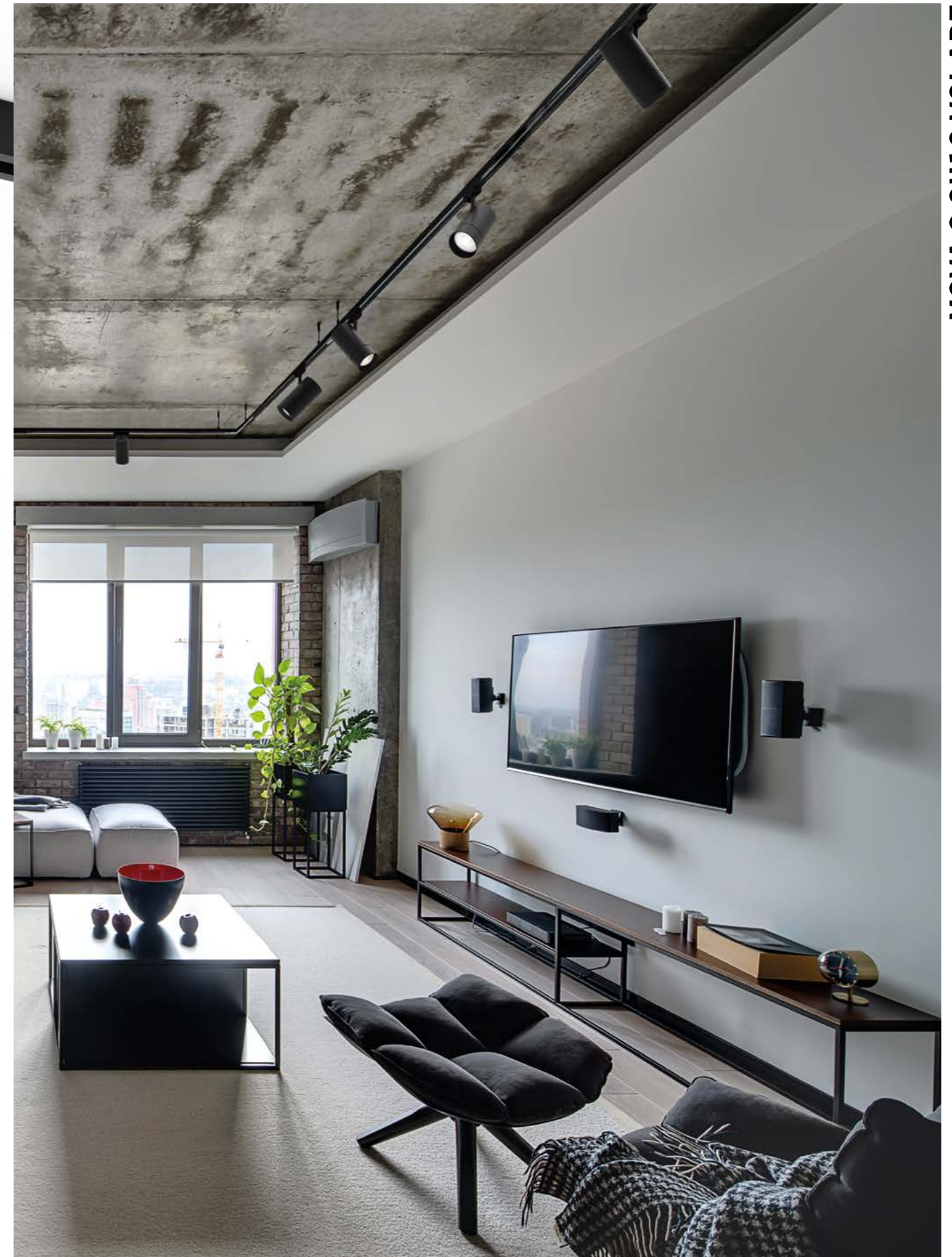

MOVA S GU10 VOLARE

For technical data and energy efficiency



MOVA S GU10 VOLARE

381

BACK TO CONTENT



CONTE VOLARE Design: INHOUSE
220-240V AC 50/60Hz QPAR 16/20 / GU10 / Retrofit max. 9W

Strahler aus Aluminium · Oberfläche in Weiß, Schwarz, Perlichrom oder Chrom · Leuchtenkopf 340° drehbar und 90° schwenkbar

Spotlight range made of aluminium · white, black, pearl chrome or chrome · spotlight head 340° swiveling and 90° tilting

Gamma faretti in alluminio · superficie bianca, nero, cromo satinato o cromo · testa proiettore girevole a 340° e inclinabile a 90°

Gamme des projecteurs en aluminium · superficie blanc, noir, chrome matt ou chrome · tête projecteur tournant à 340° et pivotant à 90°

CONTE VOLARE QPAR 16 / QPAR 20

659-00275000XX

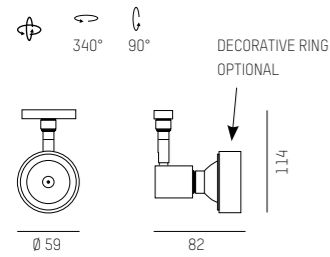

CONTE DEKORRING	FÜR	FARBE
CONTE DECORRING	FOR	COLOUR
659-000011	QPAR16	chrome
659-000012	QPAR16	pearl chrome
659-000015	QPAR16	white
659-000016	QPAR16	black
659-000021	QPAR20	chrome
659-000022	QPAR20	pearl chrome
659-000025	QPAR20	white
659-000026	QPAR20	black

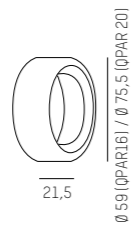

IP20 CE Leuchtmittel: Siehe Seite: 550 / lamps: look at page 550

COMPLETE CODE		
XX = COLOUR		
pearl chrome = 42	white = 55	black = 66

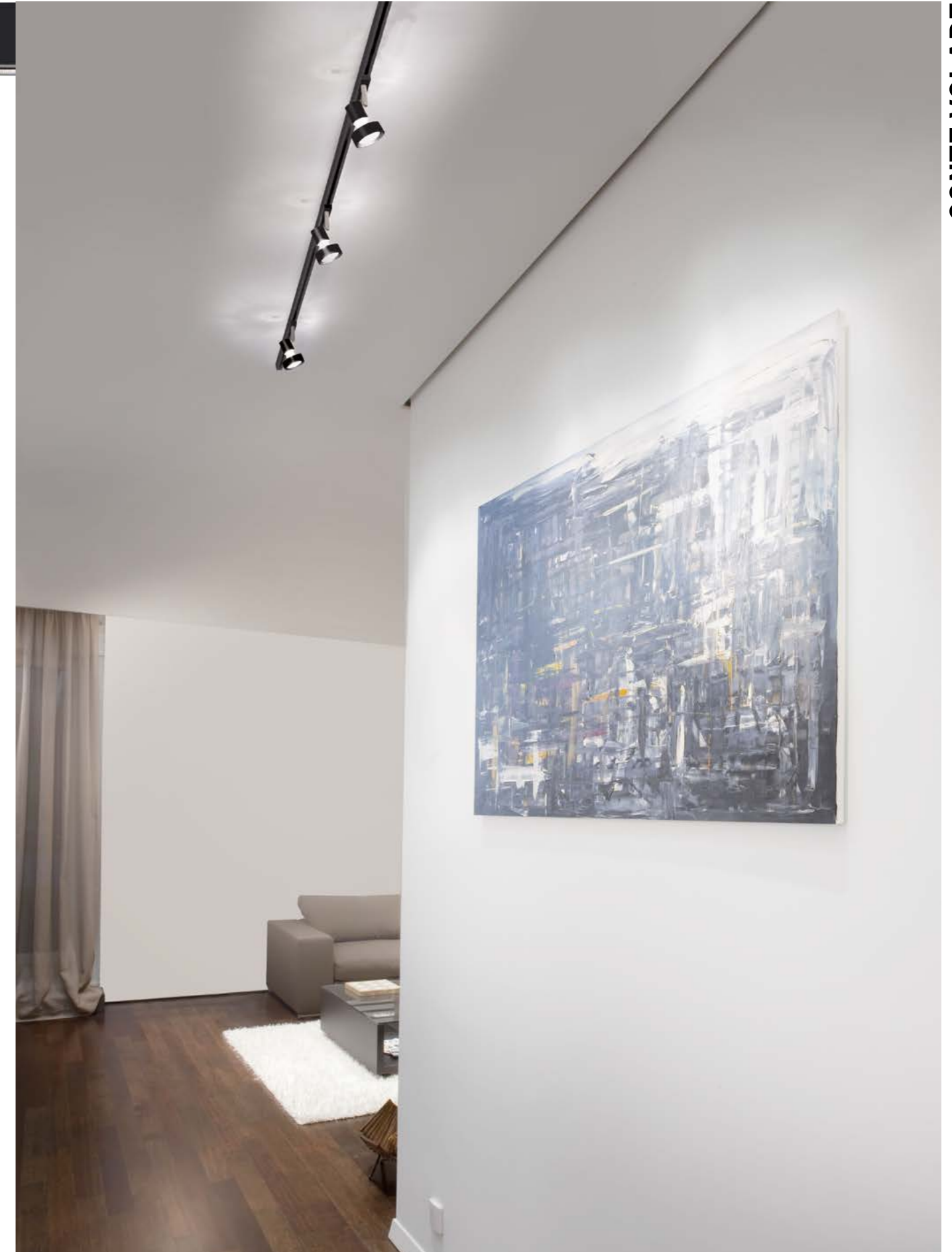

For technical data and energy efficiency





V-LINE VOLARE

Design: INHOUSE

220-240V AC 50/60Hz

Stromschienenleuchte aus stranggepresstem Aluprofil · Oberfläche pulverbeschichtet · LED Konverter im Leuchtenprofil integriert

Track luminaire · extruded aluminium profile · surface powder-coated · with LED converter in profile

Lampada in alluminio estruso per binario · verniciato a polvere · converter LED integrato nel profilo estruso

Luminaire sur rail en aluminium extrudé · vernissage à poudres · convertisseur intégré dans le profil

V-LINE VOLARE

SYS 11W	LM
694-1100210WWXX0	670 - 820
nicht dimmbar / not dimmable	



V-LINE VOLARE DIMM

SYS 9W	LM
694-1100110WWXXY	540 - 660
dimmbar / dimmable	

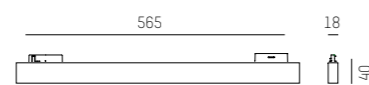

DEMONTAGEWERKZEUG / REMOVAL TOOL

652-0000100000

für V-Line Leuchten
for V-Line luminaires

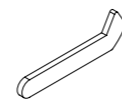

IP20 Ⓢ CE

COMPLETE CODE		
WW = LIGHT COLOUR	XX = COLOUR LUMINAIRE	Y = DIMMABLE
W2 LED 2700K = 23 CRI>90	W white = 05	L LOXONE AIR dimm = r
W3 LED 3000K = 29 CRI>90	S black = 06	B SMART BLUETOOTH dimm = b
W4 LED 4000K = 24 CRI>90		

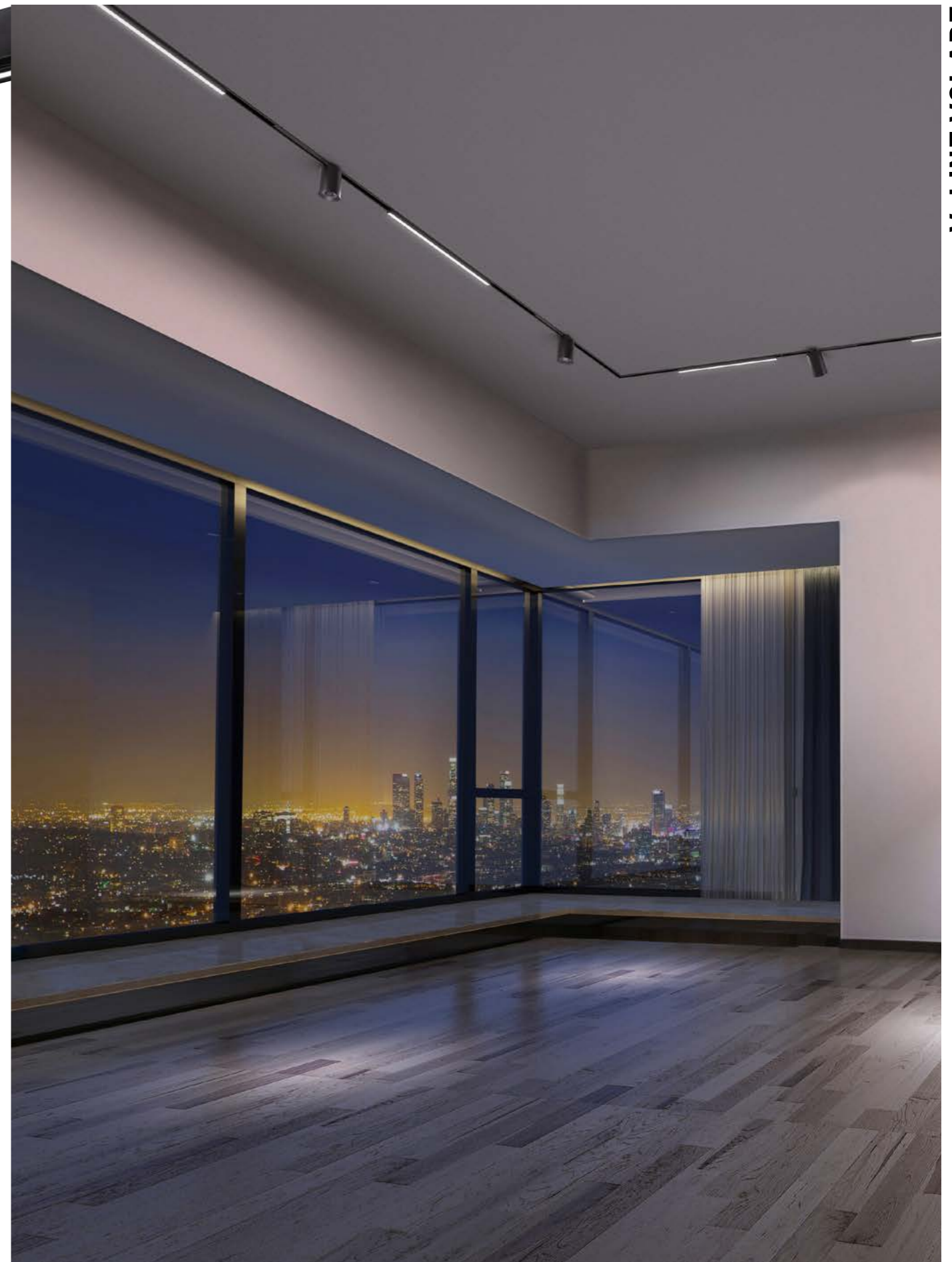

For technical data and energy efficiency





PURE ELEGANCE THAT MAKES AN IMPRESSION

Die grazile Pendelleuchte AFTER 8 hat schon immer mit ihrer klaren Formensprache und einem extra schlanken Design beeindruckt. Sie besticht durch schwebende Leichtigkeit und integriert sich exzellent in jedem Ambiente. Der schlanke Leuchtenkörper aus massivem Aluminium ist in den gebürsteten eloxierten Farben Schwarz und Bronze erhältlich. AFTER 8 erhellt mit direkt/indirektem Licht harmonisch den Raum und setzt auf minimalistische Weise edle Akzente.

AFTER 8, the graceful suspended luminaire, has always made a lasting impression, with its clear and an extra-sleek design. She appeals with its floating lightness and can be perfectly integrated in any environment. The slim body made of solid aluminium is available in the anodised colours black, and bronze. AFTER 8 harmoniously brightens up the room with direct/indirect light and creates noble accents in a minimalistic way.

Design: INHOUSE

AFTER 8



Versions

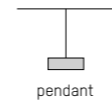

Colours



black anodized brushed



bronze anodized brushed

Light beam



pendant direct / indirect

LED Colour



2700K



3000K



4000K

Design: INHOUSE



AFTER 8 ROUND PDI Design: INHOUSE
220-240V AC 50/60Hz CRI>90

LED Hängeleuchte · extra schlank mit nur 6mm Breite · aus Aluminium mit Miniatur-LEDs · Oberfläche eloxiert · satinierte Abdeckung für homogenes Lichtbild

LED suspension · extra slim with only 6mm width · in aluminium with miniature LEDs · anodised surface · satined diffuser for homogeneous light

Sospensione LED · extra sottile con solo 6mm di spessore · in alluminio con LED miniaturizzati · superficie anodizzata · diffusore satinato per illuminazione omogenea

Suspension LED · extra fin avec seulement 6mm de large · en aluminium avec LED miniatures · surface anodisée · diffuseur satiné pour une lumière homogène

AFTER 8 ROUND PDI

SYS 54W	LM
678-0020110WWXXY	2310 - 2710

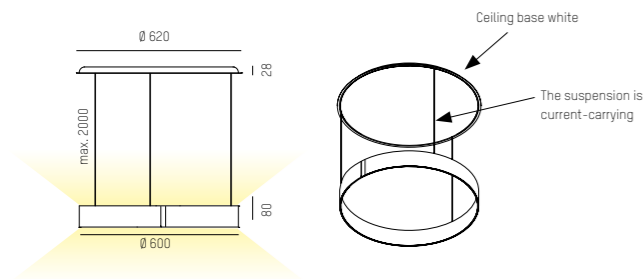

IP20 Ⓢ CE

COMPLETE CODE		
WW = LIGHT COLOUR	XX = COLOUR	Y = DIMMABLE
W2 LED 2700K = 23 CRI>90	SE black anodized brushed = 41	D DALI dimm. = d
W3 LED 3000K = 29 CRI>90	BE bronze anodized brushed = 62	A analog dimm. 1 - 10V. = a
W4 LED 4000K = 24 CRI>90		B BLUETOOTH dimm. = b

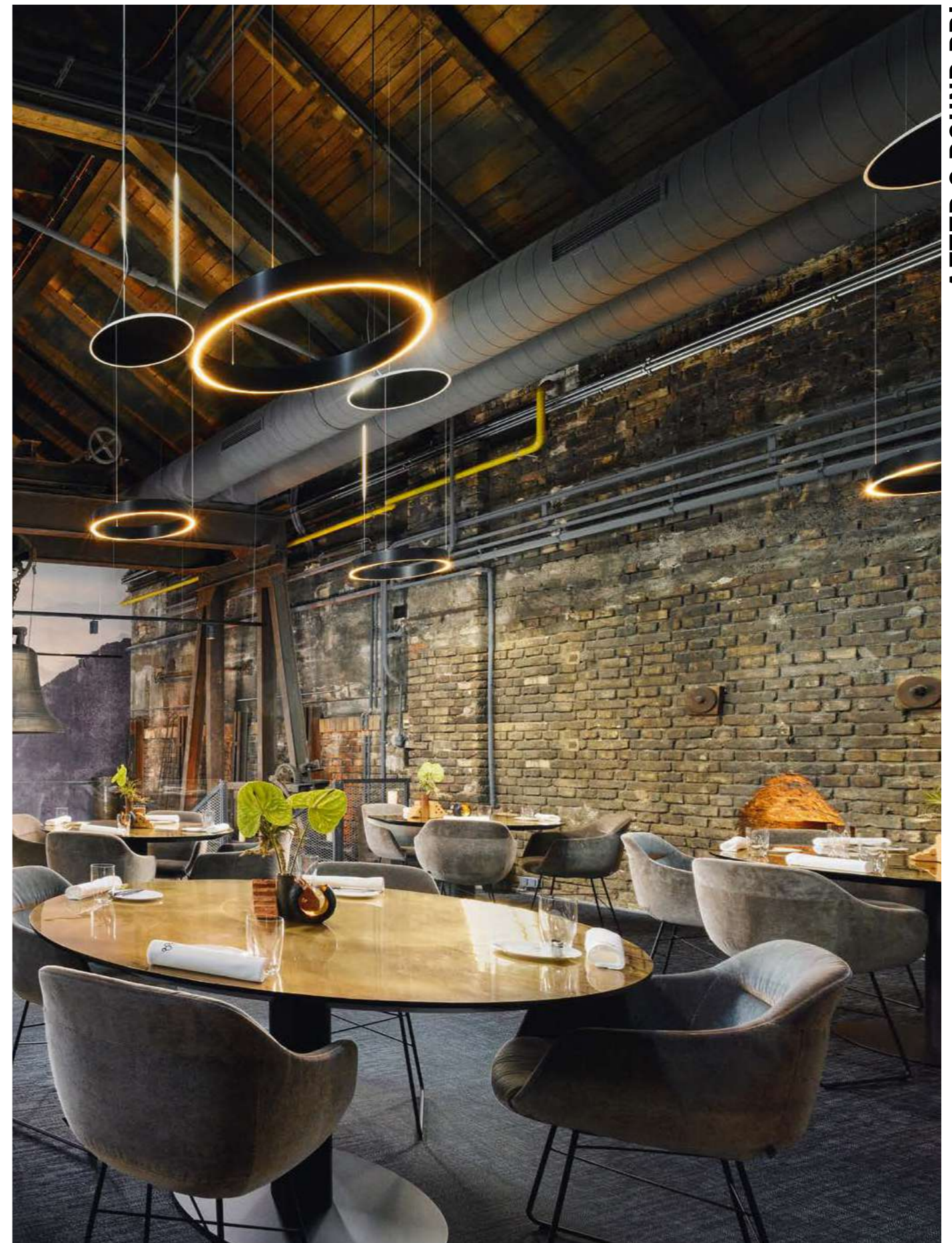

Senns Restaurant
Salzburg, Austria
Photo: Lukas Jahn

Technical data and energy efficiency





AFTER 8 PDI Design: INHOUSE
220-240V AC 50/60Hz CRI>90

LED Hängeleuchte · extra schlank mit nur 6mm Breite · aus Aluminium mit Miniatur-LEDs · Oberfläche eloxiert · satinierte Abdeckung für homogenes Lichtbild

LED suspension · extra slim with only 6mm width · in aluminium with miniature LEDs · anodised surface · satined diffuser for homogeneous light

Sospensione LED · extra sottile con solo 6mm di spessore · in alluminio con LED miniaturizzati · superficie anodizzata · diffusore satinato per illuminazione omogenea

Suspension LED · extra fin avec seulement 6mm de large · en aluminium avec LED miniatures · surface anodisée · diffuseur satiné pour une lumière homogène

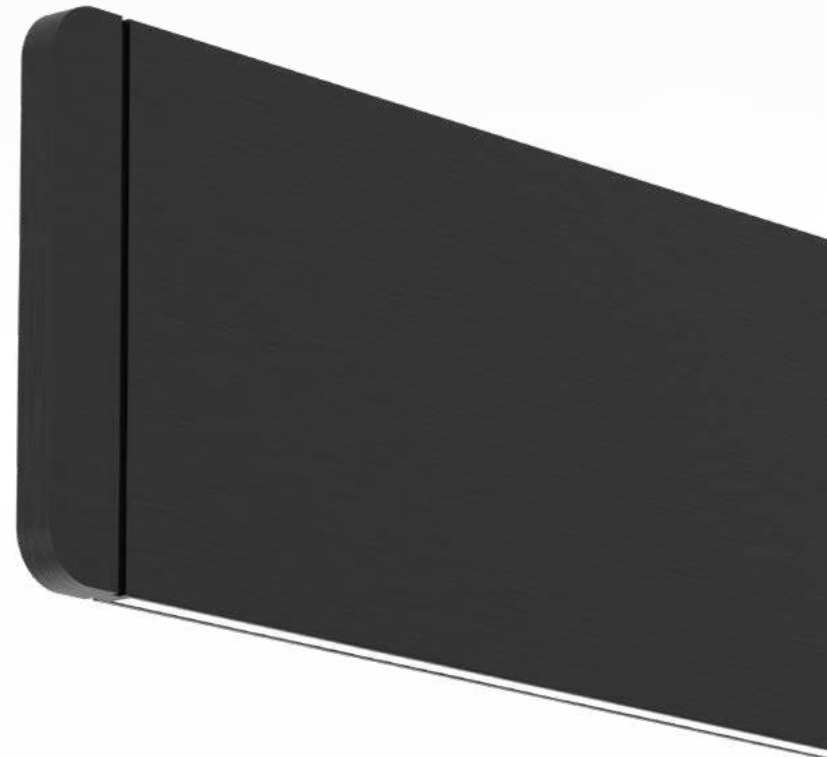

AFTER 8 PDI

SYS 41W	LM
678-0030110 WWXXY	1900 - 2070

AFTER 8 LONG PDI

SYS 51W	LM
678-0040110 WWXXY	2200 - 2400

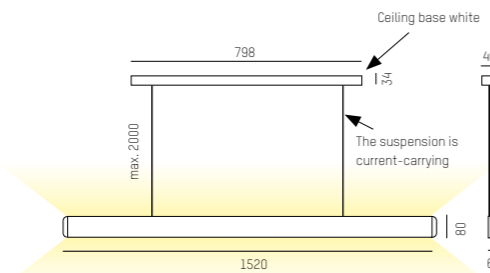
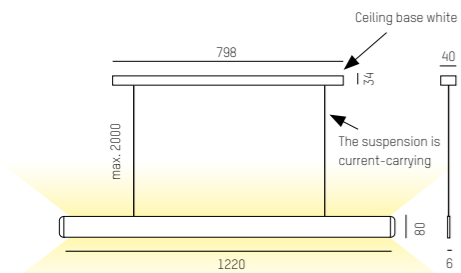

IP20

COMPLETE CODE		
WW = LIGHT COLOUR	XX = COLOUR	Y = DIMMABLE
W2 LED 2700K = 23 CRI>90	SE black anodized brushed = 41	D DALI dimm. = d
W3 LED 3000K = 29 CRI>90	BE bronze anodized brushed = 62	A analog dimm. 1 - 10V. = a
W4 LED 4000K = 24 CRI>90		B BLUETOOTH dimm. = b

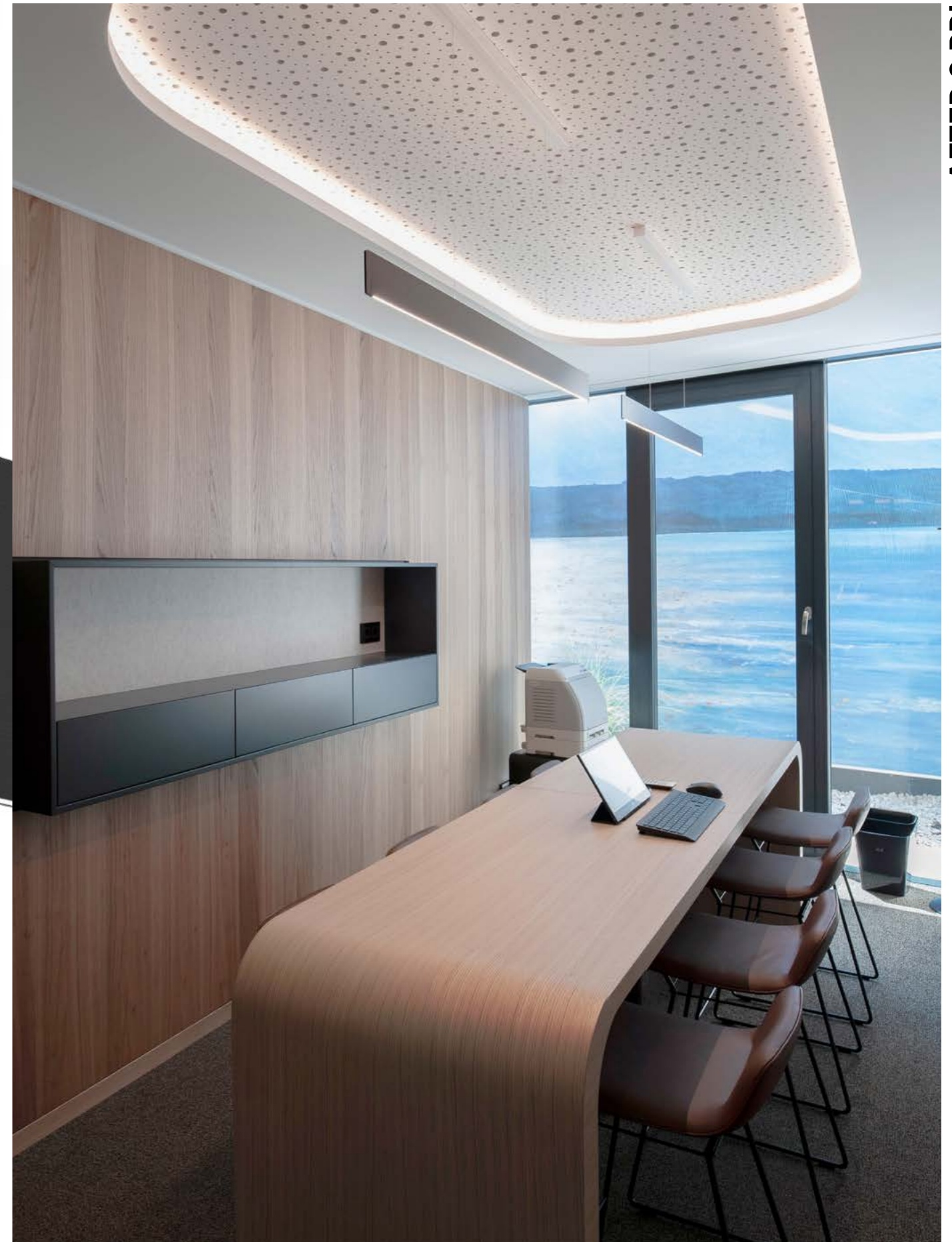

Raiffeisenbank Attersee-Süd
Nußdorf, Austria
Design + Architektur AREA.at
Photo: Joachim Rauch

Technical data and energy efficiency



AFTER 8 PDI



AFTER 8 LONG PDI



MAKES THE PULSE RISE

Die vom Designer Klaus Nolting entworfene Leuchtenfamilie besteht aus mundgeblasenem Kristallglas aus europäischer Fertigung. Der Glaskörper setzt sich aus zwei farblich, harmonisch aufeinander abgestimmten Teilen zusammen. Verbindendes Element ist ein horizontal platzierter Ring, aus dem die Glaskörper entspringen und der gleichzeitig die LEDs trägt. Die Tisch- und Stehleuchte besitzen einen Standfuß aus Stein sowie ein hochwertiges Push2Dim-Kabel. Die PILLE Single besticht mit charmantem Retro-Look und ist als Wand-, Decken- und Tischleuchte erhältlich.

The luminaire family designed by Klaus Nolting consists of mouth-blown crystal glass from European production. The glass body is composed of two parts in harmonious colours. The connecting element is a horizontally placed ring from which the glass bodies arise and which at the same time carries the LEDs. The table and floor lamps have a base out of stone and a high-quality Push2Dim cable. The PILLE Single impresses with a charming retro look and is available as a wall, ceiling and table lamp.

Design: Klaus Nolting



reddot winner 2022

PILLE

Mouthblown european crystal glass

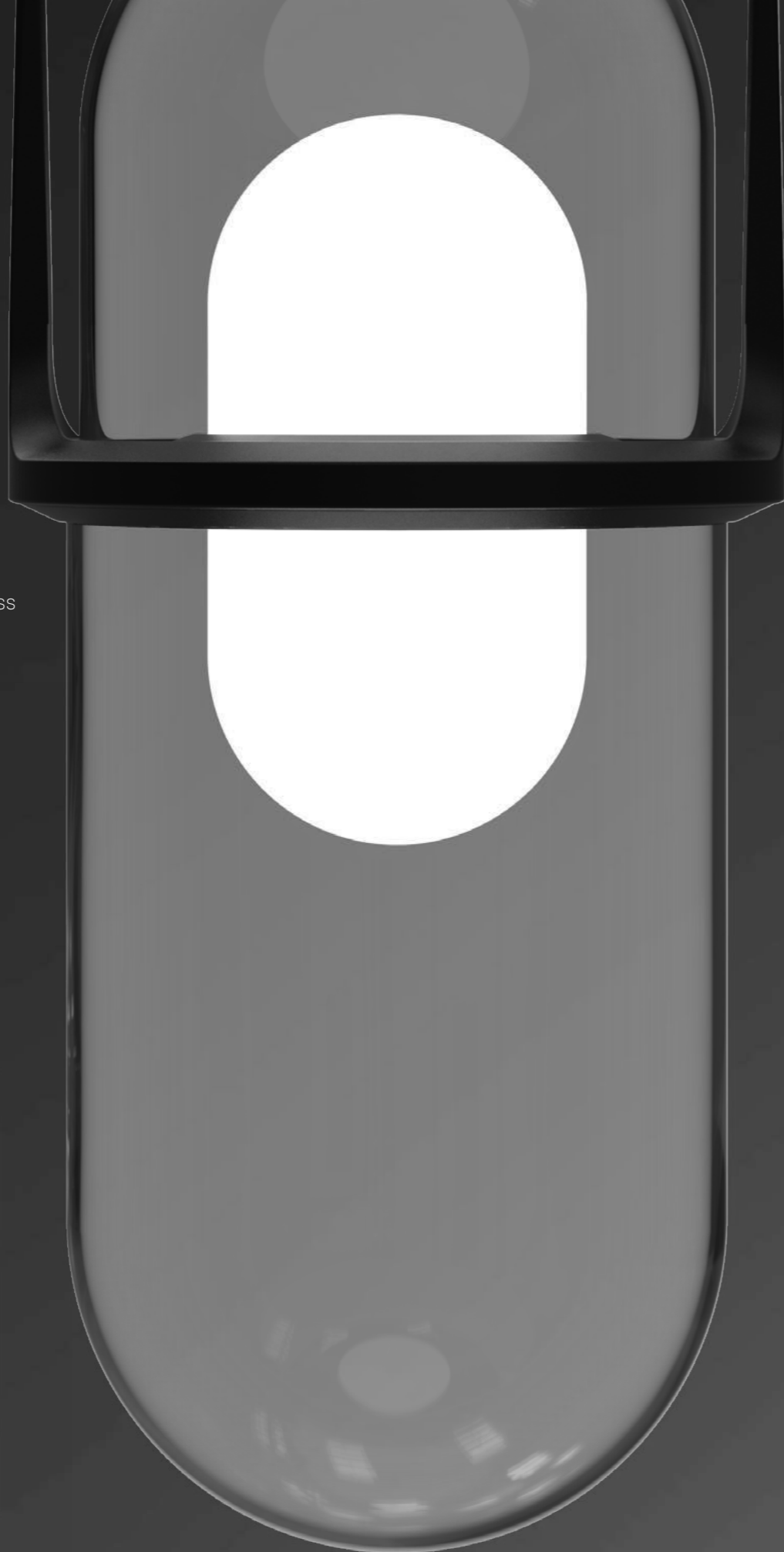

Versions



Glass colours



LED Colour



2700K

Specials



reddot winner 2022

Deign: Klaus Nolting

Information PILLE





398



399



400



PILLE

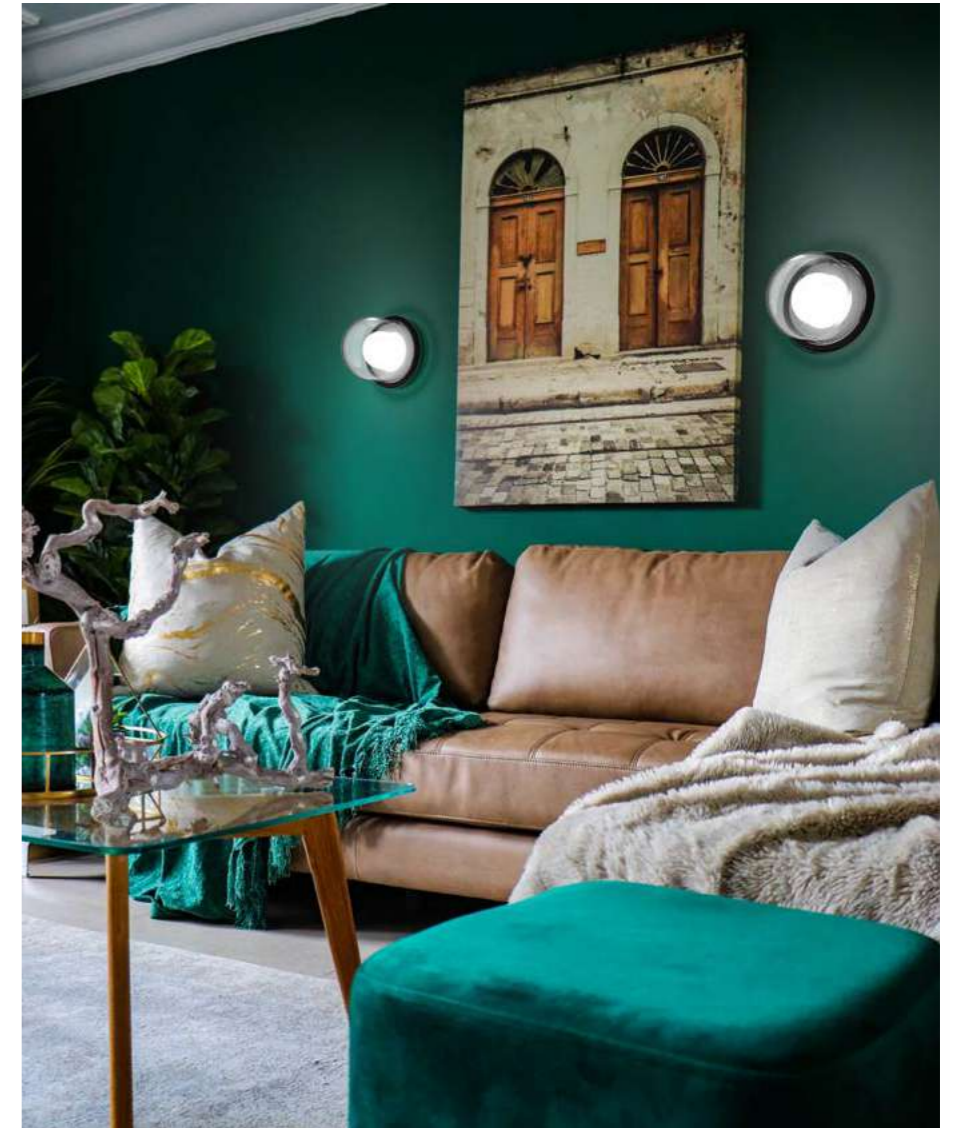

401

[BACK TO CONTENT](#)

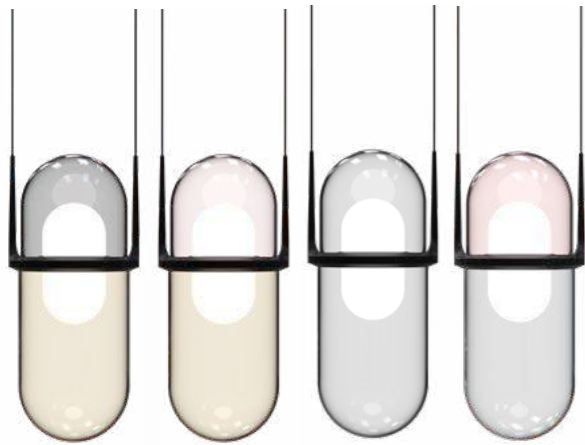

PILLE PDI Design: Klaus Nolting
 220-240V AC 50/60Hz 2700K / CRI>90

LED Hängeleuchte aus mundgeblasenem Kristallglas · unterschiedliche Farbkombinationen erhältlich · DALI dimmbar

LED suspension made of mouth-blown crystal glass · different colour combinations available · DALI dimmable

Sospensione LED in cristallo soffiato a bocca · diverse combinazioni di colori disponibili · dimmerabile DALI

Suspension LED en verre de cristal soufflé bouche · différentes combinaisons de couleurs disponibles · dimmable DALI

SYS 27W	GLAS A/B	LM	DIMM
SYS 27W	GLASS A/B	LM	DIMM
737-10013ghd	grey / champagne	1370	DALI
737-10013phd	rose / champagne	1410	DALI
737-10013ggd	grey / grey	1100	DALI
737-10013pgd	rose / grey	1150	DALI

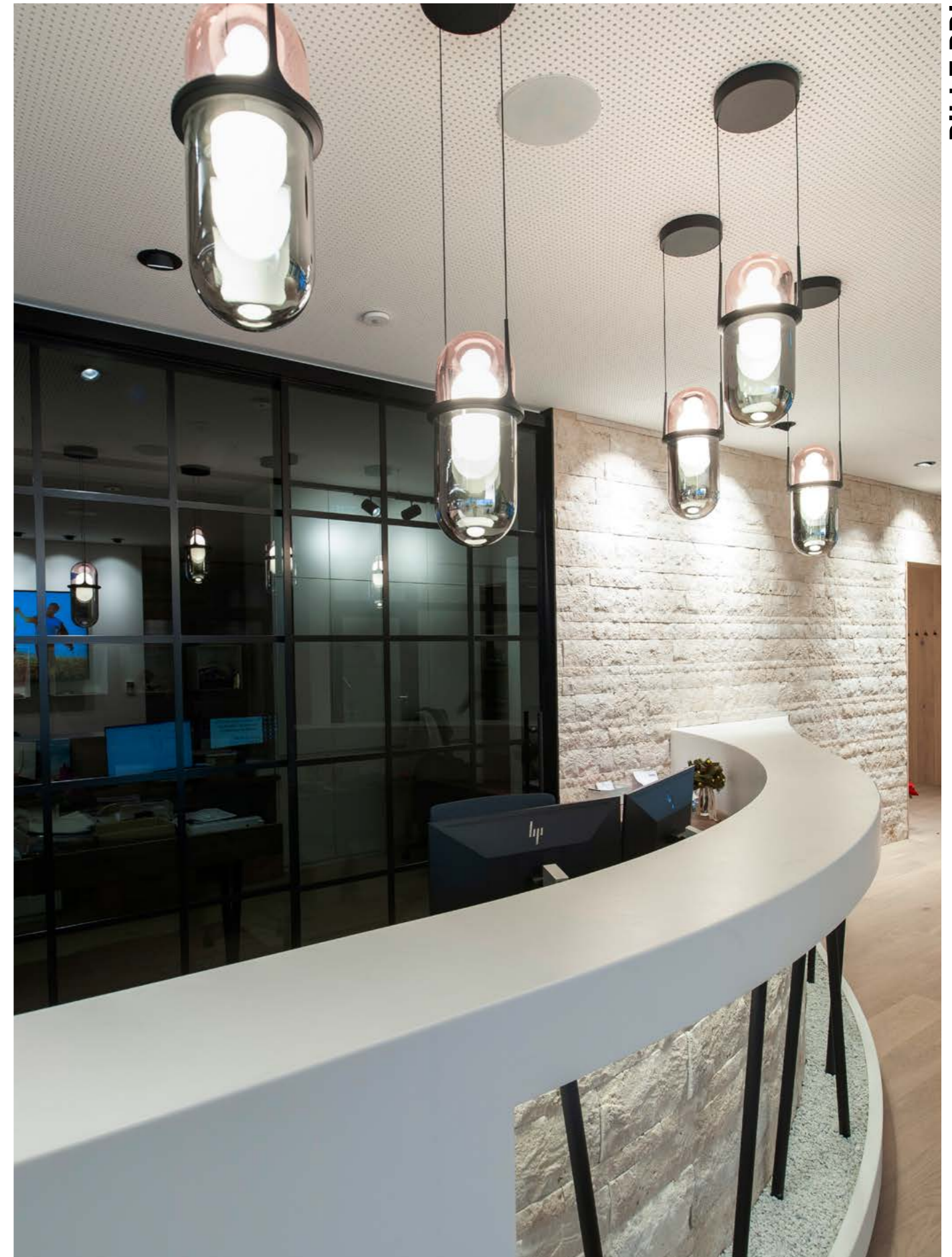
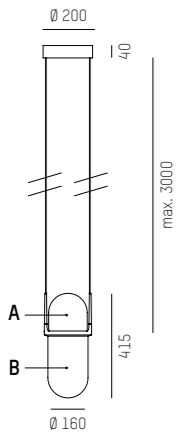

Technical data and energy efficiency

Wimberger Haus Lasberg
 Austria
 Planning & Realisation: Ben Elmecker
 Photo: Joachim Rauch



PILLE F Design: Klaus Nolting
220-240V AC 50/60Hz 2700K / CRI>90

LED Stehleuchte aus mundgeblasenem Kristallglas · unterschiedliche Farbkombinationen erhältlich · Fuß aus Naturstein · Push Dimmer am Kabel

LED floor lamp made of mouth-blown crystal glass · different colour combinations available · natural stone base · push dimmer on cable

Piantana LED in cristallo soffiato a bocca · diverse combinazioni di colori disponibili · base in pietra naturale · tasto push dimm sul cavo

Lampadaire LED en verre de cristal soufflé bouche · différentes combinaisons de couleurs disponibles · pied en pierre naturelle · push dimmer sur le câble

SYS 27W	GLAS A/B	LM	DIMM
SYS 27W	GLASS A/B	LM	DIMM
737-60013ght	grey / champagne	1370	PUSH
737-60013pht	rose / champagne	1410	PUSH
737-60013ggt	grey / grey	1100	PUSH
737-60013pgt	rose / grey	1150	PUSH

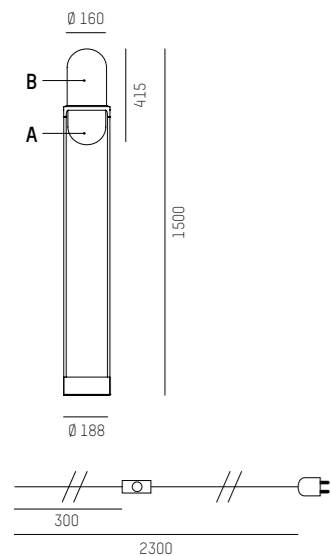

IP20

404

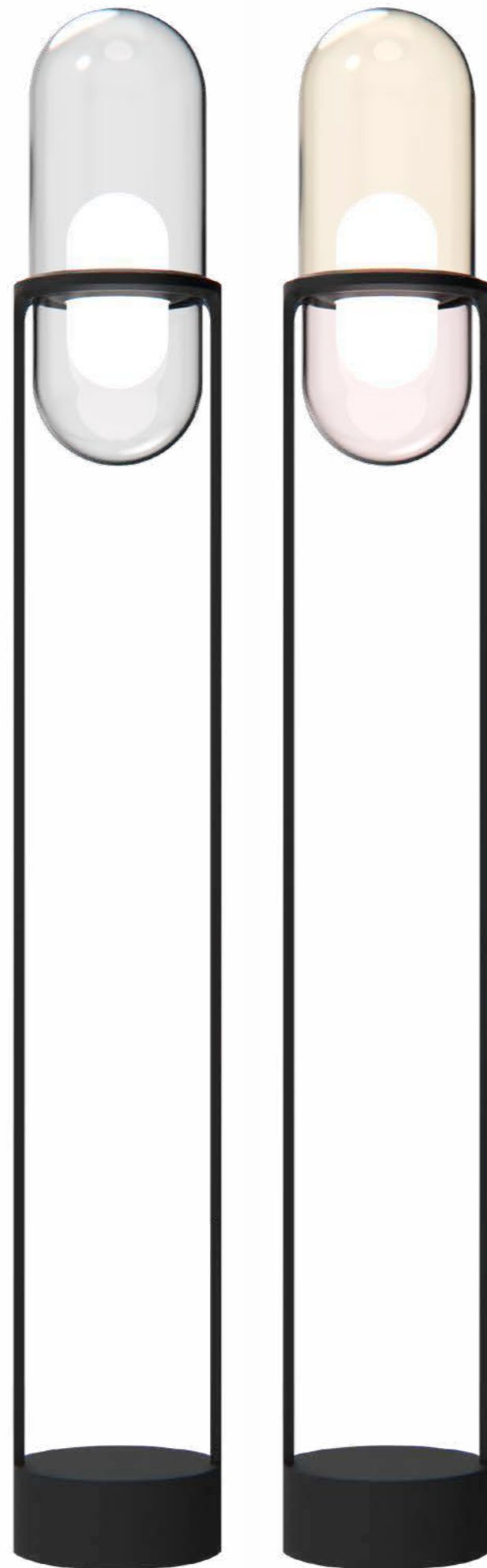

Illustration
shutterstock.com

405

Technical data and energy efficiency



PILLE F

BACK TO CONTENT

PILLE T / PILLE SINGLE L T

Design: Klaus Nolting

220-240V AC 50/60Hz 2700K / CRI>90

LED Tischleuchte aus mundgeblasenem Kristallglas · unterschiedliche Farbkombinationen erhältlich · Fuß aus Naturstein · Push Dimmer am Kabel

LED table luminaire made of mouth-blown crystal glass · different colour combinations available · natural stone base · push dimmer on cable

Lampada LED da tavolo in cristallo soffiato a bocca · diverse combinazioni di colori disponibili · base in pietra naturale · tasto push dimm sul cavo

Lampe de table à LED en verre de cristal soufflé bouche · différentes combinaisons de couleurs disponibles · pied en pierre naturelle · push dimmer sur le câble



PILLE T

SYS 28W	GLAS A/B	LM	DIMM
SYS 28W	GLASS A/B	LM	DIMM
737-50033ght	grey / champagne	1370	PUSH
737-50033pht	rose / champagne	1410	PUSH
737-50033ggt	grey / grey	1100	PUSH
737-50033pgt	rose / grey	1150	PUSH

PILLE SINGLE L T

SYS 28W	GLAS A/B	LM	DIMM
SYS 28W	GLASS A/B	LM	DIMM
737-500236ht	champagne	800	PUSH
737-500236gt	grey	540	PUSH
737-500236h0	champagne	800	switchable
737-500236g0	grey	540	switchable

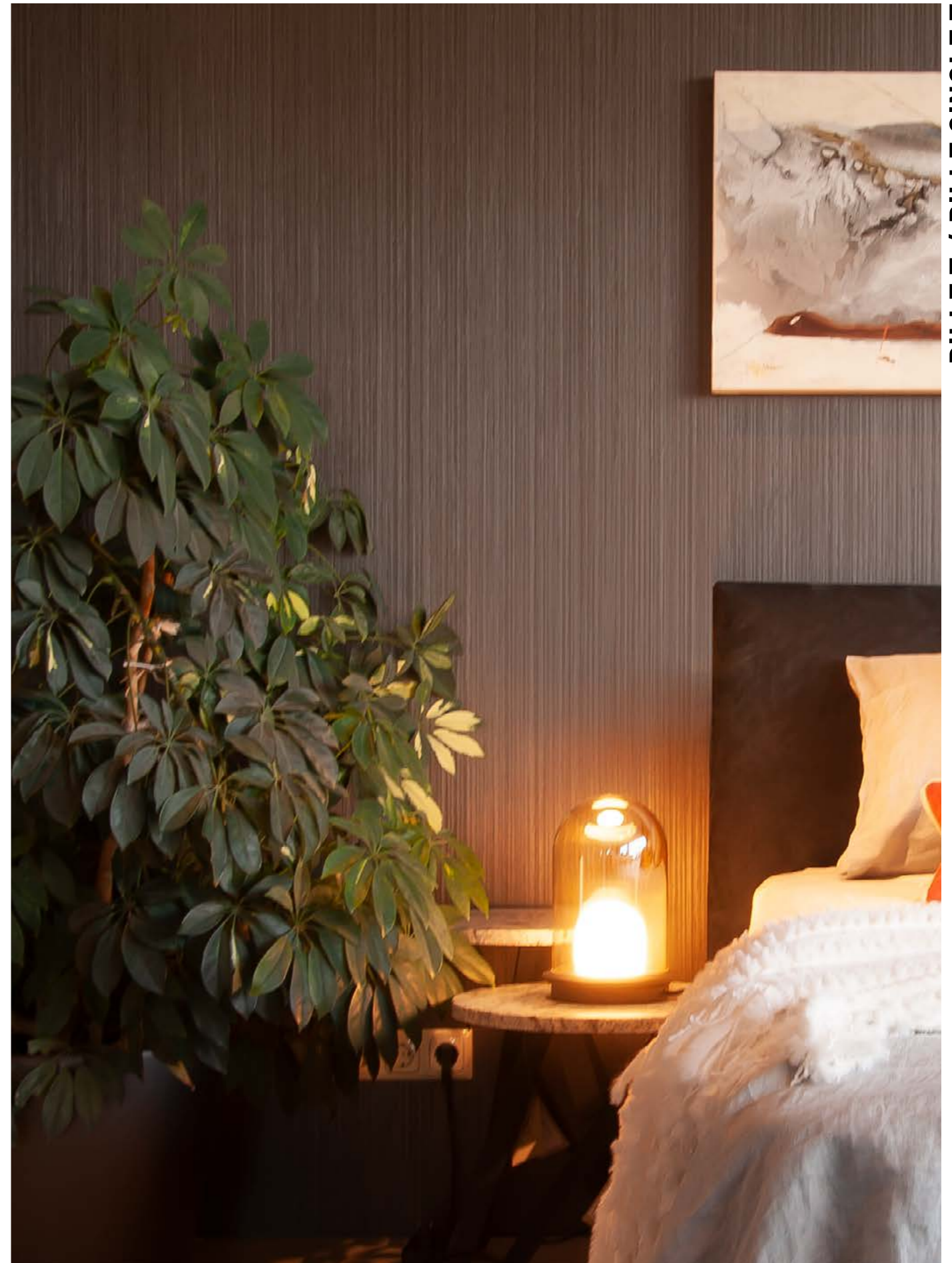
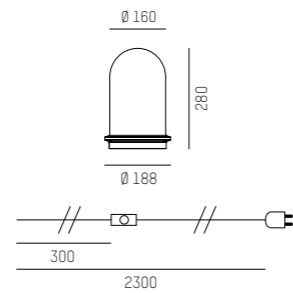
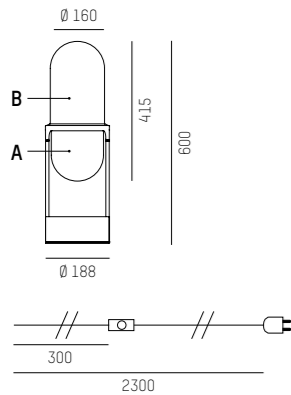

PILLE T / PILLE SINGLE L T

Technical data and energy efficiency



PILLE T



PILLE SINGLE L T



PILLE SINGLE L SD / PILLE SINGLE M SD Design: Klaus Nolting
220-240V AC 50/60Hz 2700K / CRI>90

LED Deckenleuchte aus mundgeblasenem Kristallglas · in 2 oder 3 Glasfarben erhältlich · DALI dimmbar

LED ceiling luminaire made of mouth-blown crystal glass · available in 2 or 3 glass colours · DALI dimmable

Lampada LED a plafone in cristallo soffiato a bocca · vetri disponibili in 2 o 3 colori · dimmerabile DALI

Plafonnier LED en verre de cristal soufflé bouche · disponible en 2 ou 3 couleurs de verre · dimmable DALI



PILLE SINGLE L SD

SYS 14W	GLAS	LM	DIMM
SYS 14W	GLASS	LM	DIMM
737-200136hd	champagne	800	DALI
737-200136gd	grey	540	DALI

PILLE SINGLE M SD

SYS 14W	GLAS	LM	DIMM
SYS 14W	GLASS	LM	DIMM
737-200036hd	champagne	800	DALI
737-200036gd	grey	540	DALI
737-200036pd	rose	660	DALI

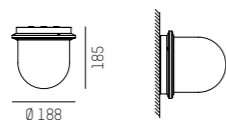
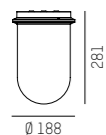

Technical data and energy efficiency



PILLE SINGLE L SD



PILLE SINGLE M SD



TAKE A GLASS OF LIGHT

Die Hängeleuchte COCKTAIL taucht den Raum auf charmante Weise in ein angenehmes Lichtbild und versprüht durch die edle Glasform eine gesellige Atmosphäre. Unterschiedliche Formen und Größen lassen spielerisch Akzente im Projekt setzen. Das mundgeblasene Kristallglas aus europäischer Fertigung ist in 3 verschiedenen Farben erhältlich. Eine zurückversetzte Lichtquelle sorgt für ein blendfreies Lichtbild.

The COCKTAIL pendant light immerses the room in a pleasant light in a charming way and its noble glass shape emits a relaxed atmosphere. Various shapes and sizes allow you to add playful accents to your project. The mouth blown crystal glass from European production is available in three different colours. A recessed light source provides a glare-free brightness.

Design: Klaus Nolting

COCKTAIL



Versions

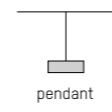

pendant

Colour



black

Glass colours



smoked grey



brown



violet

Light beam



pendant direct

LED Colour



2700K



3000K

Design: Klaus Nolting



smoked grey

violett

brown

COCKTAIL PD Design: Klaus Nolting
220-240V AC 50/60Hz CRI>90

LED Hängeleuchte aus Aluminium · Oberfläche schwarz pulverbeschichtet · Schirm aus mundeblasenem Kristallglas in 3 Farben erhältlich · perfekt entblendet · schaltbar oder DALI dimmbar

LED suspension in black aluminium · powder-coated surface · blown crystal glass shade available in 3 colours · perfect glare protection · switchable or DALI dimmable

Sospensione LED in alluminio nero · superficie verniciata a polvere · paralume in vetro soffiato a bocca disponibile in 3 colori · perfetta protezione dall'abbagliamento · on/off o dimmerabile DALI

Suspension LED en aluminium noir · surface thermolaquée · abat-jour en verre de cristal soufflé bouche disponible en 3 couleurs · protection parfaite contre l'éblouissement · on/off ou dimmable DALI

COCKTAIL S PD

SYS 10W	GLAS	LM
SYS 10W	GLASS	LM
110-011111600W60Y	smoked grey	250
110-011112600W60Y	brown	270
110-011113600W60Y	violett	300

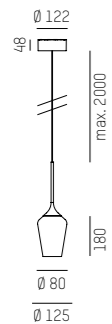

COCKTAIL M PD

SYS 10W	GLAS	LM
SYS 10W	GLASS	LM
110-0111121600W60Y	smoked grey	310
110-0111122600W60Y	brown	320
110-0111123600W60Y	violett	300

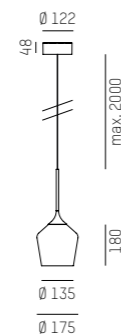

IP20 CE

COMPLETE CODE	
W = LIGHT COLOUR	Y = DIMMABLE
W2 LED 2700K = 3 CRI>90	Ⓢ switchable = 0
W3 LED 3000K = 9 CRI>90	Ⓣ DALI dimm. = d

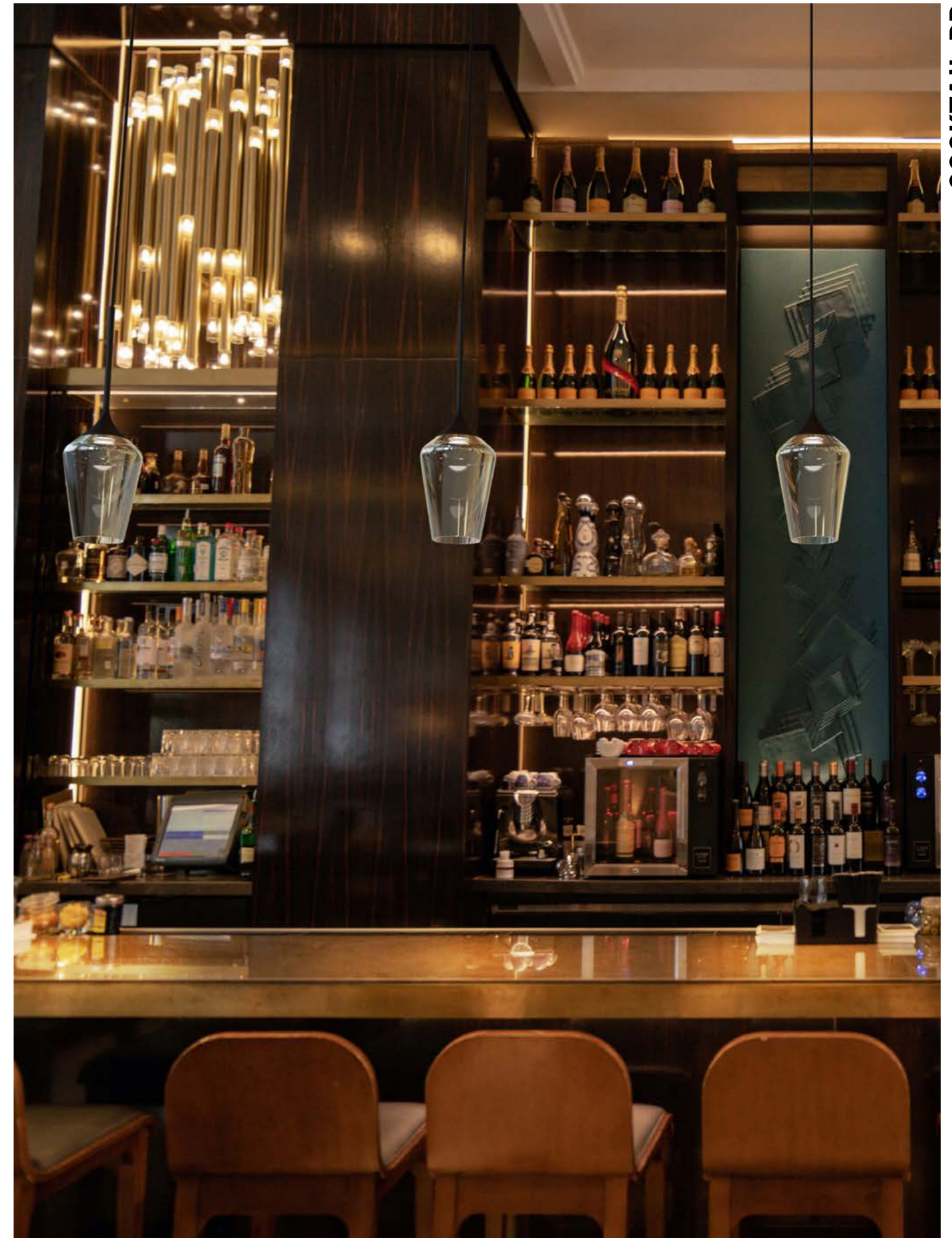

COCKTAIL PD

Technical data and energy efficiency



COCKTAIL S PD



COCKTAIL M PD



COCKTAIL L PD Design: Klaus Notting
220-240V AC 50/60Hz CRI>90

LED Hängeleuchte aus Aluminium · Oberfläche schwarz pulverbeschichtet · Schirm aus mundgeblasenem Kristallglas in 3 Farben erhältlich · perfekt entblendet · schaltbar oder DALI dimmbar

LED suspension in black aluminium · powder-coated surface · blown crystal glass shade available in 3 colours · perfect glare protection · switchable or DALI dimmable

Sospensione LED in alluminio nero · superficie verniciata a polvere · paralume in vetro soffiato a bocca disponibile in 3 colori · perfetta protezione dall'abbagliamento · on off o dimmerabile DALI

Suspension LED en aluminium noir · surface thermolaquée · abat-jour en verre de cristal soufflé bouche disponible en 3 couleurs · protection parfaite contre l'éblouissement · on/off ou dimmable DALI

COCKTAIL L PD

SYS 10W	GLAS	LM
SYS 10W	GLASS	LM
110-011131600W60Y	smoked grey	330
110-011132600W60Y	brown	350
110-011133600W60Y	violett	370

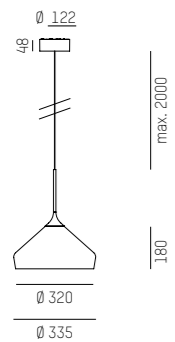

IP20

COMPLETE CODE	
W = LIGHT COLOUR	Y = DIMMABLE
W2 LED 2700K = 3 CRI>90	S switchable = 0
W3 LED 3000K = 9 CRI>90	D DALI dimm. = d



Technical data and energy efficiency



CORPA PD Design: Rainer Mutsch
220-240V AC 50/60Hz QPAR 16 / GU10 / Retrofit max. 9W

Hängeleuchte aus Aluminium · hochwertige mundgeblasene Glasschirme · Oberfläche pulverbeschichtet · GU10 Abhängung

Suspension in aluminium · high quality mouth blown glass shades · surface powder-coated · GU10 suspension

Lampada a sospensione in alluminio · paralume in vetro soffiato a bocca di alta qualità · superficie verniciata a polvere · portalampana GU10

Suspension en aluminium · abat-jour en verre soufflé bouche de haute qualité · surface thermolaquée · suspension GU10



CORPA IRIS S PD	FARBE	GLAS
CORPA IRIS S PD	COLOUR	GLASS
257-0211116000600	black	champagner
257-0211126000600	black	grey
257-0211136000600	black	rose

CORPA IRIS L PD	FARBE	GLAS
CORPA IRIS L PD	COLOUR	GLASS
257-0211216000600	black	champagner
257-0211226000600	black	grey
257-0211236000600	black	rose

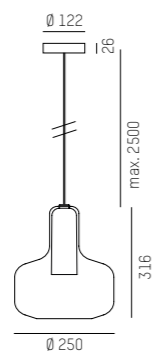
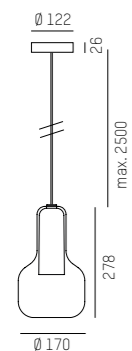

CORPA BASS PD	FARBE	GLAS
CORPA BASS PD	COLOUR	GLASS
257-0211316000600	black	champagner
257-0211326000600	black	grey

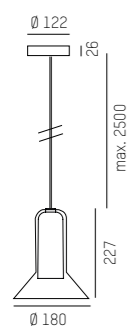

IP 20 Leuchtmittel: Siehe Seite: 550 / lamps: look at page 550



Freiraum
Freistadt, Austria
Planing/Realisation: Ben Elmecker
Photo: Martin Pröll

Technical data and energy efficiency



CORPA IRIS S PD



CORPA IRIS L PD



CORPA BASS PD

LOON MINI BALL PD Design: INHOUSE
 220-240V AC 50/60Hz D45 / E14 / Retrofit max. 4W

Hängeleuchte aus Metall mit E14 Fassung · Oberfläche pulverbeschichtet · hochwertige mundgeblasene Glaskugel

Suspension in metal with E14 socket · surface powder-coated · high quality mouth blown glass ball

Sospensione in metallo con portalampada E14 · superficie verniciata a polvere · sfera in vetro soffiato a bocca di alta qualità

Suspension en métal avec douille E14 · surface thermolaquée · boule en verre soufflé bouche de haute qualité

LOON MINI BASE PD	FARBE
LOON MINI BASE PD	COLOUR
636-0110006000600	black

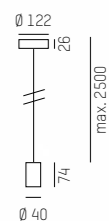

LOON MINI BALL PD	FARBE	GLAS
LOON MINI BALL PD	COLOUR	GLASS
636-0131116000600	black	grey
636-0131126000600	black	amber
636-0131136000600	black	brown

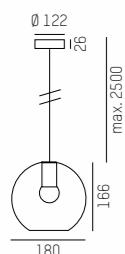

IP20 Leuchtmittel: Siehe Seite: 550 / lamps: look at page 550



LOON MINI BALL PD

Technical data and energy efficiency



LOON MINI BASE PD



LOON MINI BALL PD

Frieseursalon g'kampelt & g'schnien
 St. Martin, Austria
 Leibez Interior Design

LOON PD Design: INHOUSE
220-240V AC 50/60Hz A60 / E27 / Retrofit max. 7W

Dekorative Hängeleuchte im Retro-Design · speziell konstruierte E27 Metall-Fassung für bündige Montage · Oberfläche pulverbeschichtet · hochwertiges Glas mundgeblasen in 3 Farben

Decorative suspension in retro design · specially designed E27 metal socket for flush mounting · surface powder-coated · high quality mouth blown glass in 3 colours

Sospensione decorativa dal design retrò · portalampada E27 in metallo appositamente progettato per montaggio a filo · superficie verniciata a polvere · sfera in vetro soffiato a bocca di alta qualità in 3 colori

Suspension décorative au design rétro · douille métallique E27 spécialement conçue pour un montage affleurant · surface thermolaquée · boule en verre soufflé bouche de haute qualité, disponible en 3 couleurs

LOON BASE PD	FARBE
LOON BASE PD	COLOUR
636-0210005000500	white
636-0210006000600	black

ohne Glas / without glass

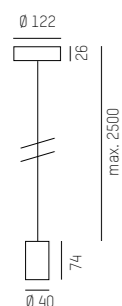

LOON BALL PD	FARBE	GLAS
LOON BALL PD	COLOUR	GLASS
636-0231216000600	black	grey
636-0231226000600	black	amber
636-0231236000600	black	brown

mit Glas / with glass

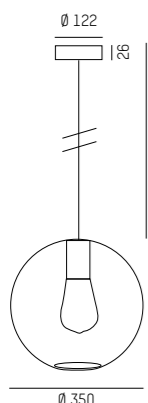

LOON SOFT PD	FARBE	GLAS
LOON SOFT PD	COLOUR	GLASS
636-0231416000600	black	grey
636-0231426000600	black	amber
636-0231436000600	black	brown

mit Glas / with glass

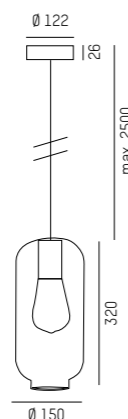

LOON PD





LEO PD

220-240V AC 50/60Hz QPAR 16 / GU10 / Retrofit max. 9W

Hängeleuchte aus Aluminium · Oberfläche pulverbeschichtet · mit oder ohne rauchgrauem satinierten Glas erhältlich · GU10 Fassung · schaltbar

Suspension in black aluminium · surface powder-coated · available with or without smoked grey satin glass · GU10 socket

Sospensione in alluminio nero · superficie verniciata a polvere · disponibile con o senza vetro satinato grigio fumé · portalampada GU10

Suspension en aluminium noir · surface thermolaquée · disponible avec ou sans verre satiné gris fumé · douille GU10

LEO 1 PD	FARBE
LEO 1 PD	COLOUR
194-01100000006060	black

ohne Glas / without glass

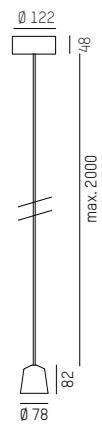

LEO 2 PD	FARBE	SCHIRM
LEO 2 PD	COLOUR	SHADE
194-02100000006060	black	smoked grey

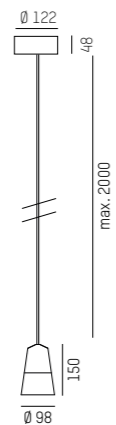

LEO PD

Technical data and energy efficiency



LEO 1 PD



LEO 2 PD



Versions

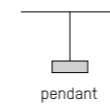

Core colours



black anodized



gold anodized

Light beam



pendant direct / indirect

MAGICAL MOMENTS OF LIGHT

WIZARD ist eine charmante Hängeleuchte aus eloxiertem Aluminium. Der Metallschirm ist in 2 unterschiedlichen Größen sowie verschiedenen Farbkombinationen erhältlich und kann je nach Wunsch flexibel in der Schräge eingestellt werden. Der direkte und indirekte Lichtaustritt sorgen für eine zauberhafte Lichtstimmung im Raum.

WIZARD is a charming pendant luminaire made of anodised aluminium. The metal cover is available in two different sizes as well as various colour combinations and the angle can be adjusted according to your wishes. The direct and indirect light output provides the room with magical mood lighting.

Design: Serge Cornelissen



WIZARD PDI Design: Serge Cornelissen
220-240V AC 50/60Hz

Hängeleuchte mit E27 · Frei schwenkbarer Schirm aus Aluminium eloxiert · in unterschiedlichen Farbkombinationen erhältlich · Lichtstimmung durch direkten und indirekten Lichtaustritt

Suspension with E27 socket · flexible adjustable shade made of anodised aluminium · available in different colour combinations · lighting mood through direct and indirect light emission

Sospensione con portalampada E27 · paralume flessibile e regolabile in alluminio anodizzato · disponibile in diverse combinazioni di colori · emissione luminosa diretta ed indiretta

Suspension avec douille E27 · abat-jour en aluminium anodisé réglable de manière flexible · disponible en différentes combinaisons de couleurs · ambiance lumineuse agréable grâce à une diffusion · directe et indirecte de la lumière

WIZARD M PDI

A60 ECO / E27 / max. 45W	SCHIRM 1	SCHIRM 2
A60 ECO / E27 / max. 45W	SHADE 1	SHADE 2
114-0111000666500	black	black
114-0111000667500	black	gold
114-0111000676500	gold	black
114-0111000677500	gold	gold

Schirm eloxiert / shade anodized

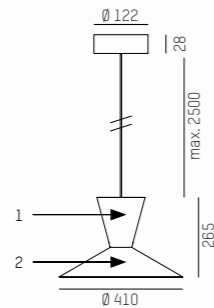

WIZARD L PDI

A60 ECO / E27 / max. 45W	SCHIRM 1	SCHIRM 2
A60 ECO / E27 / max. 45W	SHADE 1	SHADE 2
114-0211000666500	black	black
114-0211000667500	black	gold
114-0211000676500	gold	black
114-0211000677500	gold	gold

Schirm eloxiert / shade anodized

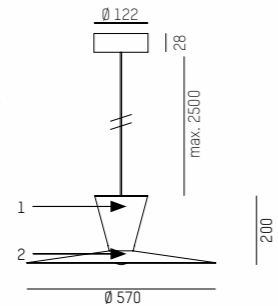

Technical data and energy efficiency



WIZARD PD

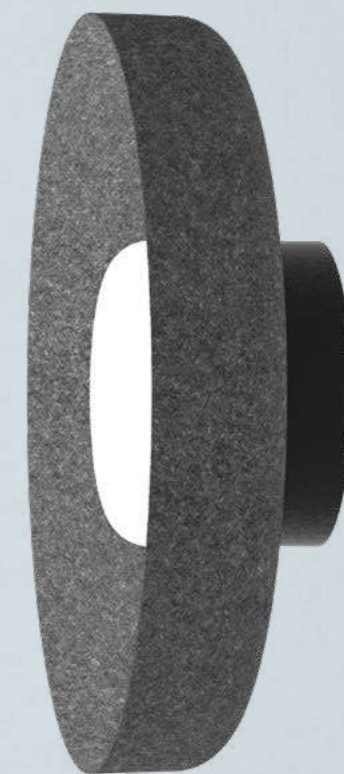

SWAP AS YOU WANT

SVEN ist eine wandelbare Leuchte in schlichtem Retrodesign. Der Leuchtschirm ist in verschiedenen Farben und Materialien erhältlich. Durch einfaches Tauschen des Schirmes lässt sich die Leuchte an unterschiedliche Anlässe oder Trends individuell anpassen. Ein flexibler Silikon Diffusor schafft eine angenehme und weiche Lichtverteilung. Erhältlich ist SVEN als Hängeleuchte sowie als stilvoller Eyecatcher an der Wand.

SVEN is a convertible luminaire in a simple retro design. The luminaire cover is available in various colours and materials. By simply exchanging the cover the luminaire can be adjusted for different occasions or to individual trends. The flexible silicone diffuser creates a pleasant and soft distribution of light. SVEN is available as a pendant luminaire as well as a stylish eye-catcher on the wall.

Design: Rainer Mutsch

SVEN



SVEN PD/SD Design: Rainer Mutsch
220-240V AC 50/60Hz LED 2700 / 3000K CRI>90

LED Leuchtenfamilie mit Schirm aus Metall oder Filz · Oberfläche pulverbeschichtet · weiche Lichtverteilung durch Silikondiffusor · schaltbar oder DALI dimmbar (PD)

LED luminaire family with metal or felt shade · surface powder-coated · soft light distribution due to silicone diffuser · switchable or DALI dimmable (PD)

Famiglia di lampade LED con paralume in metallo o feltro · superficie verniciata a polvere · distribuzione confortevole della luce grazie al diffusore in silicone · on/off o dimmerabile DALI (PD)

Famille de luminaires LED avec abat-jour en métal ou feutre · surface thermolaquée · diffusion douce de la lumière par diffuseur flexible en silicone · on/off ou dimmable DALI (PD)

SVEN PD

SYS 15W	MATERIAL	FARBE	LM
SYS 15W	MATERIAL	COLOUR	LM
136-1003s6gY	metall	merlot	1045
136-1003s6hY	metall	creme	1230
136-1003s6lY	metall	forest	1030
136-1003s66Y	metall	black	1040
136-1004s69Y	felt	anthrazith	1045

Lichtfarbe 2700 oder 3000K manuell einstellbar
Light colour 2700 or 3000K adjustable

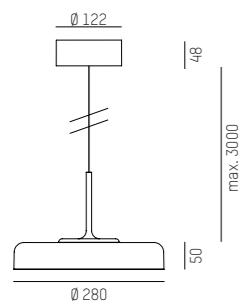

SVEN SD

SYS 12W	MATERIAL	FARBE	LM
SYS 12W	MATERIAL	COLOUR	LM
136-2003s6gd	metall	merlot	1045
136-2003s6hd	metall	creme	1230
136-2003s6ld	metall	forest	1030
136-2003s66d	metall	black	1040
136-2004s69d	felt	anthrazith	1045

DALI dimmbar
Lichtfarbe 2700 oder 3000K manuell einstellbar

DALI dimmable
Light colour 2700 or 3000K adjustable

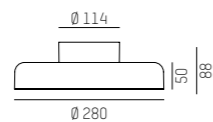

IP20 Ⓢ CE

COMPLETE CODE	
Y	= DIMMABLE
Ⓢ	switchable = 0
Ⓣ	DALI dimm. = d

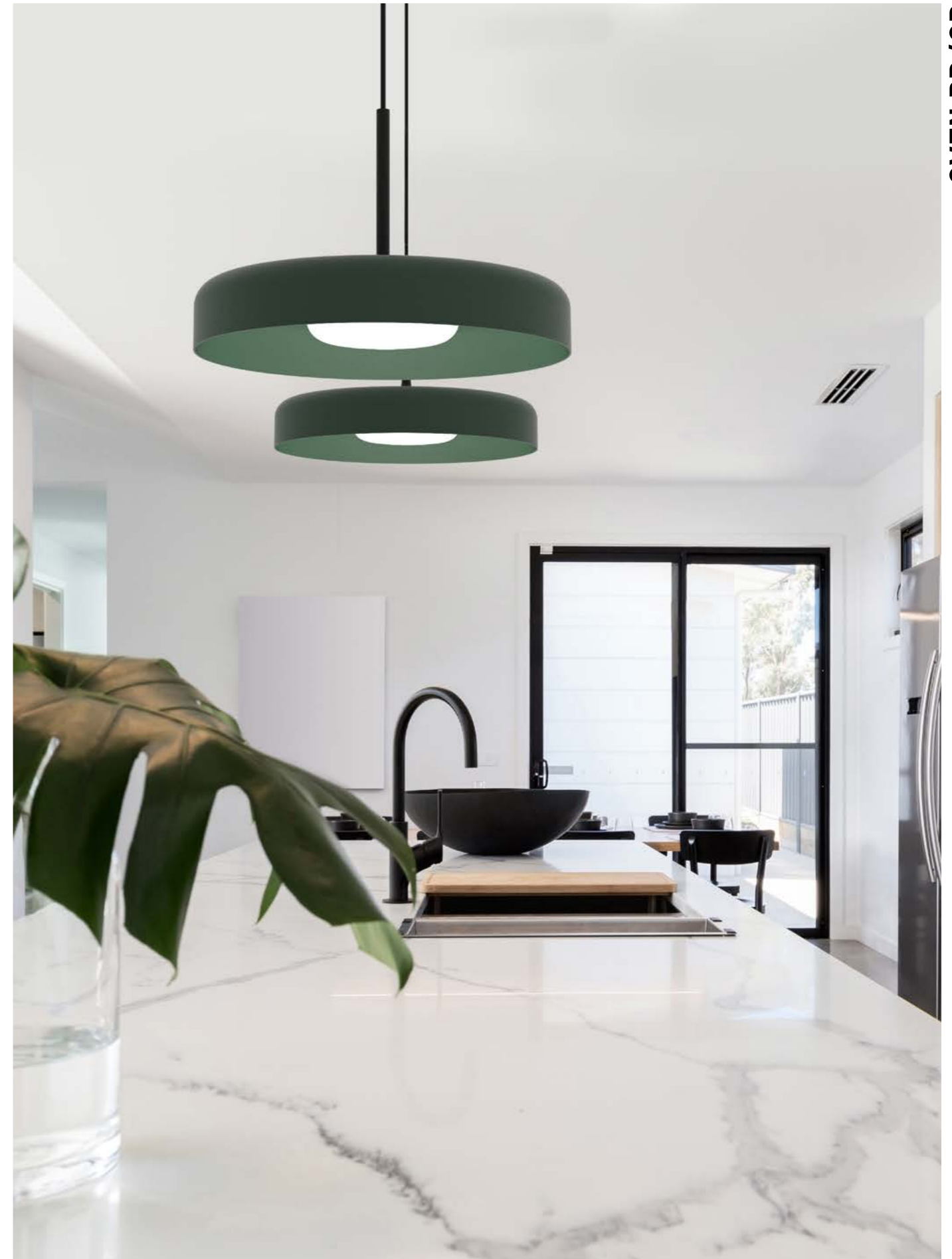

Technical data and energy efficiency



SVEN PD



SVEN SD



Gmundner Keramik
Gmunden, Austria
Photo: Joachim Rauch



TIMELESS, TRADITIONAL & HANDCRAFTED

Gmundner Keramik und Molto Luce, zwei oberösterreichische Betriebe mit jeweils eigener Produktion, gelten als Experten ihres Gebietes. Im Rahmen eines Designprojektes entwickelten sie gemeinsam die charmante Leuchtenserie FRANZ, welche eine Pendel-, Decken- und Wandleuchte umfasst. Die hochwertigen Keramikschirme werden mit Liebe zum Detail in Handarbeit in der Gmundner Keramik Manufaktur gefertigt und bemalt. So wird jede Leuchte zum Unikat. Ob mit traditionellem "Hirsch" oder in drei wunderschönen Farben glasiert und gebrannt, ist FRANZ perfekt für einen Einsatz im privaten Wohnraum oder in der Gastronomie geschaffen. Technisch ist die Leuchte mit einer modernen Light Engine von Molto Luce ausgestattet, welche eine sanfte und besonders angenehme Verteilung des Lichts ermöglicht.

Gmundner Keramik and Molto Luce, two upper Austrian companies with their own production each, are renowned experts in their areas. As part of a design project, they developed the charming series of luminaires FRANZ together including a pendant luminaire, a ceiling and a wall mounted luminaire. The high-quality ceramic shades are made and painted by hand with love for detail in the manufactory of Gmundner Keramik. Therefore, every luminaire is unique. Whether painted with the traditional deer or glazed and fired in three beautiful colours, FRANZ is perfect for the private living space or in restaurants. The luminaire is equipped with the modern Light Engine by Molto Luce for a soft and especially pleasant light distribution.

Design: Gmundner Keramik & Rainer Mutsch



FRANZ PD/SD

FRANZ



omeagreen



deer grey 3 x small



bronze



seablue



seablue

bronze

deer grey 1 x big

omeagreen



FRANZ PD/SD



FRANZ PD/SD Design: Gmundner Keramik & Rainer Mutsch
220-240V AC 50/60Hz LED 2700 / 3000K CRI>90

LED Leuchtenfamilie mit Schirm aus Keramik · Oberfläche gebrannt und glasiert · weiche Lichtverteilung durch Silikondiffusor · schaltbar oder DALI dimmbar (PD)

LED luminaire family with ceramic shade · surface fired and glazed · soft light distribution due to silicone diffuser · switchable or DALI dimmable (PD)

Famiglia di lampade LED con paralume in ceramiche · superficie cotto e smaltato · distribuzione confortevole della luce grazie al diffusore in silicone · on off o dimmerabile DALI (PD)

Famille de luminaires LED avec abat-jour en céramique · surface cuit et émaillé · diffusion douce de la lumière par diffuseur flexible en silicone · on/off ou dimmable DALI (PD)

FRANZ PD

SYS 15W	MATERIAL	FARBE	LM
SYS 15W	MATERIAL	COLOUR	LM
136-1005s6fY	ceramics	omeagreen	1045
136-1005s6bY	ceramics	seablue	1230
136-1005s6rY	ceramics	bronze	1030
136-1005s6sY	ceramics	deer grey 3 x small	1040

Lichtfarbe 2700 oder 3000K manuell einstellbar
Light colour 2700 or 3000K adjustable

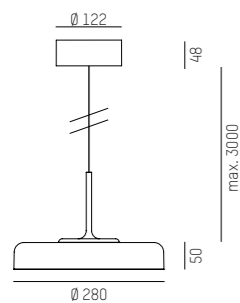

IP20

FRANZ SD

SYS 12W	MATERIAL	FARBE	LM
SYS 12W	MATERIAL	COLOUR	LM
136-2005s6fd	ceramics	omeagreen	1045
136-2005s6bd	ceramics	seablue	1230
136-2005s6rd	ceramics	bronze	1030
136-2005s6sd	ceramics	deer grey 1 x big	1040
136-2006s6sd	ceramics	deer grey 3 x small	1040

DALI dimmbar
Lichtfarbe 2700 oder 3000K manuell einstellbar
DALI dimmable
Light colour 2700 or 3000K adjustable

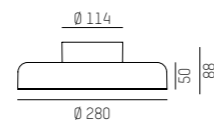

FRANZ PD/SD

COMPLETE CODE	
Y	= DIMMABLE
Ⓢ	switchable = 0
Ⓣ	DALI dimm. = d

Technical data and energy efficiency



FRANZ PD



FRANZ SD

Gmundner Keramik
Gmundner, Austria
Photo: Joachim Rauch



LORA PD

220-240V AC 50/60Hz CRI>90

LED Hängeleuchte aus Aluminium · in unterschiedlichen trendigen Schirm-
ausführungen aus Stahl · Oberfläche pulverbeschichtet · Kabel aus Kunst-
stoff · schaltbar oder DALI dimmbar

LED suspension in aluminium · steel shade in different trendy designs ·
surface powder-coated · synthetic cable · switchable or DALI dimmable

Sospensione LED in alluminio · paralume in diverse forme particolari ·
superficie verniciata a polvere · cavo con rivestimento in materiale plas-
tico · on off o dimmerabile DALI

Suspension LED en aluminium · abat-jour disponible avec différentes
finitions tendance · surface thermolaquée · câble en synthétiques ·
on/off ou dimmable DALI

LORA 1 PD

SYS 10W LM
SYS 10W LM
176-10201000WWXXY 600

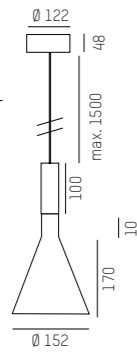

LORA 2 PD

SYS 10W LM
SYS 10W LM
176-10202000WWXXY 600

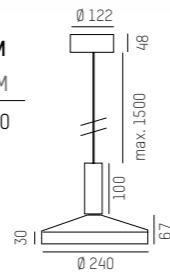

LORA 3 PD

SYS 10W LM
SYS 10W LM
176-10203000WWXXY 600

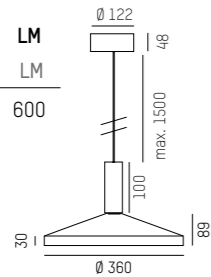

LORA 4 PD

SYS 10W LM
SYS 10W LM
176-10204000WWXXY 600

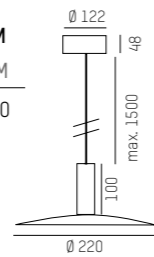

LORA 5 PD

SYS 10W LM
SYS 10W LM
176-10205000WWXXY 600

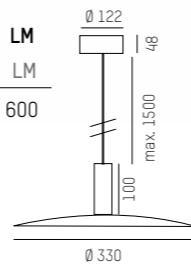

IP20 CE

COMPLETE CODE			
WW = LIGHT COLOUR	X = COLOUR LUMINAIRE	X = COLOUR SHADE	Y = DIMMABLE
W2 LED 2700K = 23 CRI>90	W white = 5	W white = 5	S switchable = 0
W3 LED 3000K = 29 CRI>90	S black = 6	S black = 6	D DALI dimm. = d



Carpe Diem
Linz, Austria
Photo: Joachim Rauch



LORA 1 PD
441



LORA 2 PD



LORA 3 PD



LORA 4 PD



LORA 5 PD

Technical data and energy efficiency



Schirm braun - Licht aus
shade brown - light off

Schirm braun - Licht ein
shade brown - light on

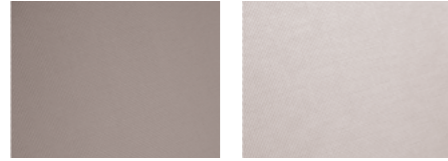

Schirm grau - Licht aus
shade grey - light off

Schirm grau - Licht ein
shade grey - light on

BIVIO PD

Design: Michael Raasch

220-240V AC 50/60Hz

Hängeleuchte mit E14 Fassung · Oberfläche pulverbeschichtet · Schirm aus Leinenstoff · symmetrische Befestigung · Kabel aus schwarzem Kunststoffgeflecht

Pendant luminaire with E14 socket · surface powder-coated · linen shade symmetric fixing · black synthetic fabric cable

Sospensione con portalampada E14 · superficie verniciata a polvere · paralume in lino · fissaggio simmetrico · cavo nero con rivestimento in materiale plastico intrecciato

Suspension avec douille E14 · surface thermolaquée · abat-jour en toile de lin · fixation symétrique · câble noir en fibres synthétiques



BIVIO S PD

A60 ECO / E27 / max. 45W	FARBE	SCHIRM
A60 ECO / E27 / max. 45W	COLOUR	SHADE
645-103030000120	black	grey
645-103030000230	black	brown

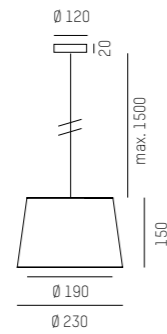

BIVIO M PD

A60 ECO / E27 / max. 45W	FARBE	SCHIRM
A60 ECO / E27 / max. 45W	COLOUR	SHADE
645-103040000120	black	grey
645-103040000230	black	brown

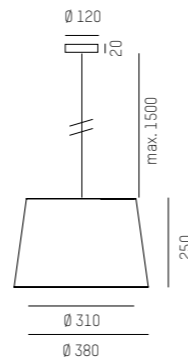

BIVIO L PD

A60 ECO / E27 / max. 45W	FARBE	SCHIRM
A60 ECO / E27 / max. 45W	COLOUR	SHADE
645-103050000120	black	grey
645-103050000230	black	brown

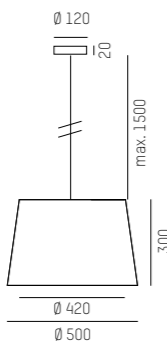

BIVIO XL PD

A60 ECO / E27 / max. 45W	FARBE	SCHIRM
A60 ECO / E27 / max. 45W	COLOUR	SHADE
645-103060000120	black	grey
645-103060000230	black	brown

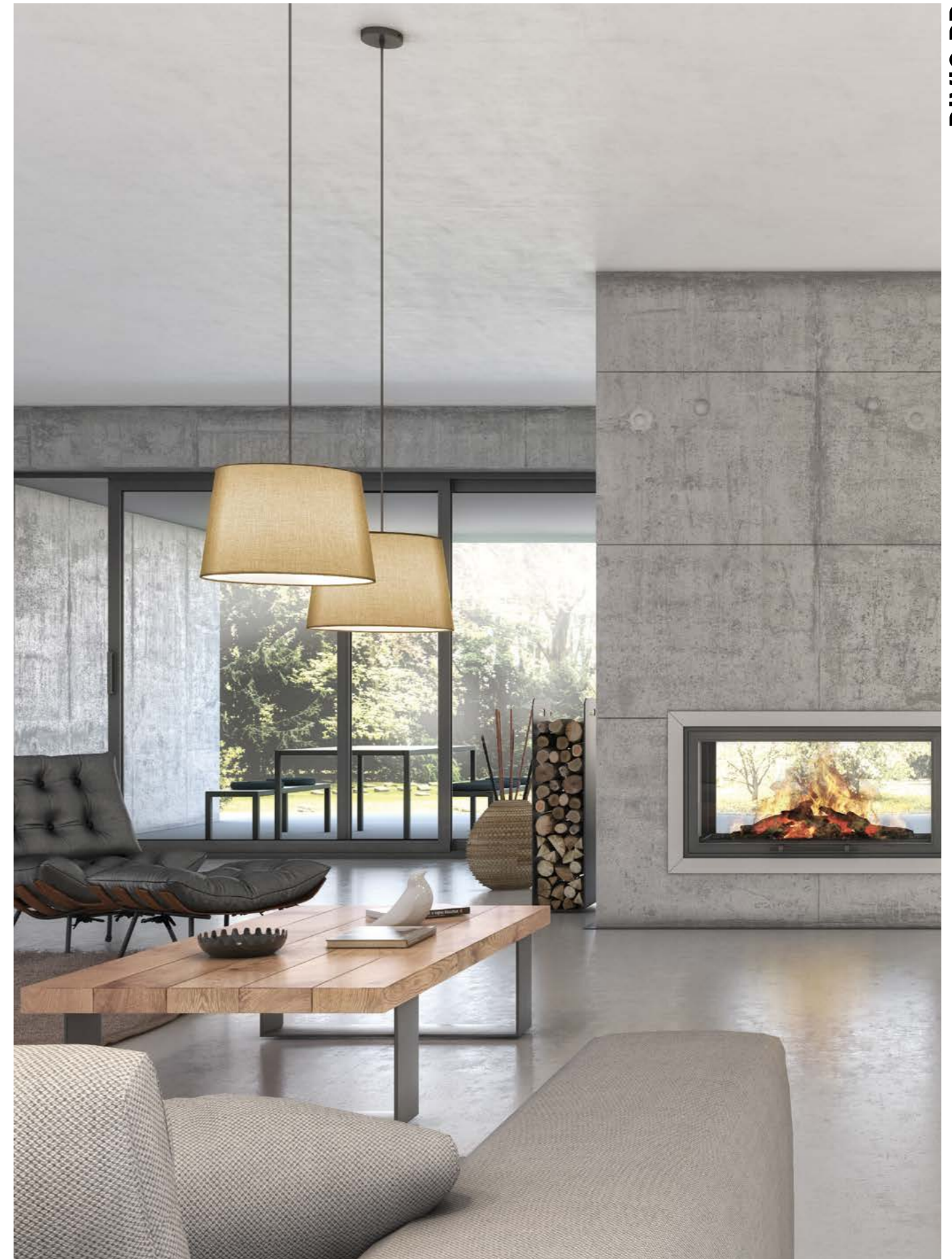
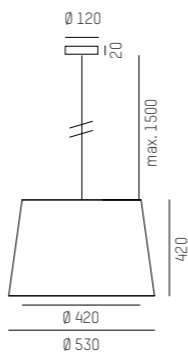

BIVIO PD

Technical data and energy efficiency



BIVIO PD



Schirm braun - Licht aus
shade brown - light off

Schirm braun - Licht ein
shade brown - light on

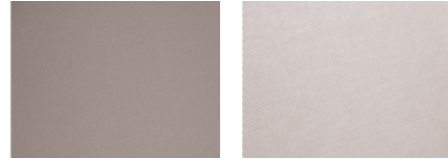

Schirm grau - Licht aus
shade grey - light off

Schirm grau - Licht ein
shade grey - light on



BIVIO W Design: Michael Raasch
220-240V AC 50/60Hz

Wandleuchte mit E14 Fassung · Oberfläche pulverbeschichtet · Schirm aus Leinenstoff · asymmetrische Befestigung · mit oder ohne Leselicht erhältlich

Wall luminaire with E14 socket · surface powder-coated · linen shade asymmetric fixing · available with or without reading light

Lampada da parete con portalampada E14 · superficie verniciata a polvere paralume in lino · fissaggio asimmetrico · disponibile con o senza luce di lettura

Applique murale avec douille E14 · surface thermolaquée · abat-jour en toile de lin · fixation asymétrique · disponible avec ou sans liseuse

BIVIO W

D45 ECO / E14 / max. 30W	FARBE	SCHIRM
D45 ECO / E14 / max. 30W	COLOUR	SHADE
645-102030000120	black	grey
645-102030000230	black	brown

BIVIO W WITH LED SPOT

SYS 4W / 3000K / 130lm / CRI>80 / 12° +

D45 ECO / E14 / max. 30W	FARBE	SCHIRM
D45 ECO / E14 / max. 30W	COLOUR	SHADE
645-101030519120	black	grey
645-101030519230	black	brown

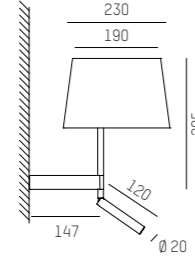
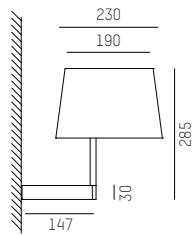

Technical data and energy efficiency



BIVIO W



BIVIO W SPOT



Schirm braun - Licht aus
shade brown - light off

Schirm braun - Licht ein
shade brown - light on

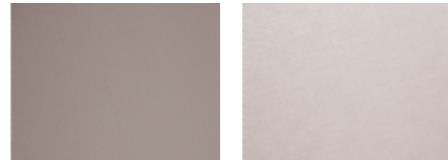

Schirm grau - Licht aus
shade grey - light off

Schirm grau - Licht ein
shade grey - light on



BIVIO T Design: Michael Raasch
220-240V AC 50/60Hz

Tischleuchte mit E27 Fassung · Oberfläche pulverbeschichtet · Schirm aus Leinenstoff · asymmetrische Befestigung · Fuß mit Kabelschalter

Table luminaire with E27 socket · surface powder-coated · linen shade asymmetric fixing · base with cable switch

Lampada da tavolo con portalampana E27 · superficie verniciata a polvere · paralume in lino · fissaggio asimmetrico · base con cavo ed interruttore

Lampe de table avec douille E27 · surface thermolaquée · abat-jour en toile de lin · fixation asymétrique · câble avec interrupteur relié au socle

BIVIO M T

D45 ECO / E14 / max. 30W	FARBE	SCHIRM
D45 ECO / E14 / max. 30W	COLOUR	SHADE
645-104030000120	black	grey
645-104030000230	black	brown

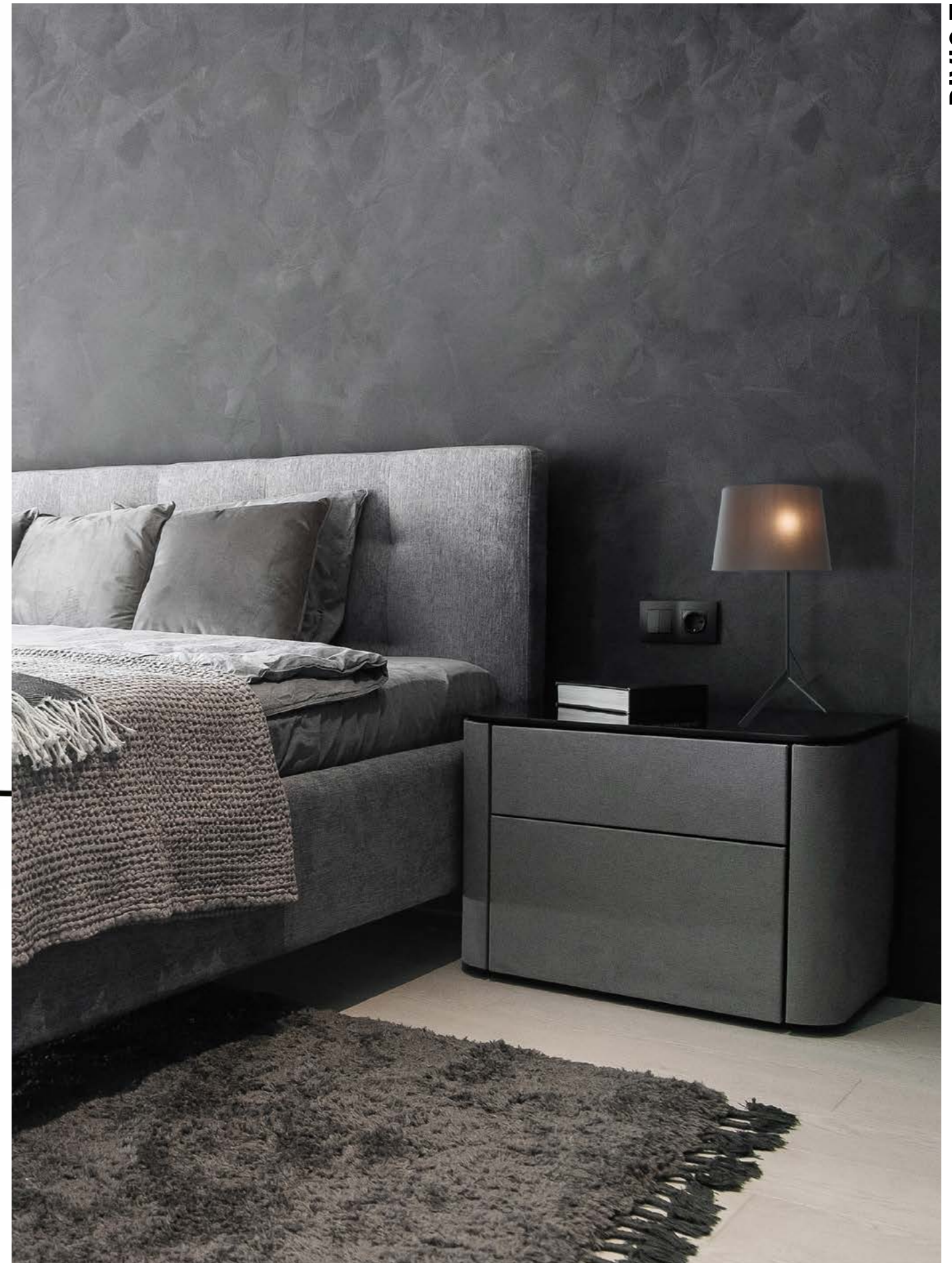
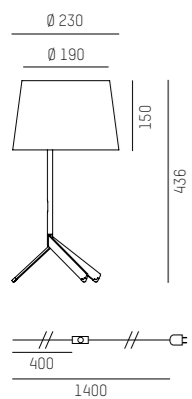

BIVIO T

Technical data and energy efficiency



BIVIO T



BIVIO F Design: Michael Raasch
220-240V AC 50/60Hz

Stehleuchte mit E27 Fassung · Oberfläche pulverbeschichtet · Schirm aus Leinenstoff · asymmetrische Befestigung · Kabel aus schwarzem Kunststoffgeflecht

Floor lamp with E27 socket · powder-coated surface · linen shade · asymmetric fixing · black synthetic fabric cable

Piantana con portalamпада E27 · superficie verniciata a polvere · paralume in lino · fissaggio asimmetrico · cavo nero con rivestimento in materiale plastico intrecciato

Lampadaire avec douille E27 · surface thermolaquée · abat-jour en toile de lin · fixation asymétrique · câble noir en fibres synthétiques



BIVIO M F

A60 ECO / E27 / max. 45W	FARBE	SCHIRM
A60 ECO / E27 / max. 45W	COLOUR	SHADE
645-10505000012a	black	grey
645-10505000023a	black	brown

mit Schirm Ø 500mm, analog dimm. 1-10V
with shade Ø 500mm, analog dimm. 1-10V

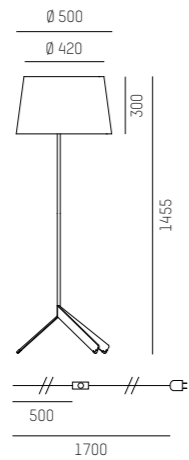

BIVIO M F

A60 ECO / E27 / max. 45W	FARBE	SCHIRM
A60 ECO / E27 / max. 45W	COLOUR	SHADE
645-10506000012a	black	grey
645-10506000023a	black	brown

mit Schirm Ø 530mm, analog dimm. 1-10V
with shade Ø 530mm, analog dimm. 1-10V

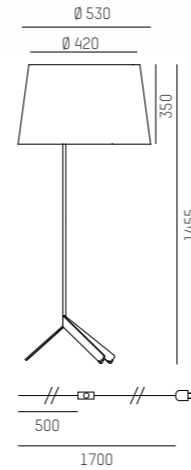

BIVIO L F

A60 ECO / E27 / max. 45W	FARBE	SCHIRM
A60 ECO / E27 / max. 45W	COLOUR	SHADE
645-10605000012a	black	grey
645-10605000023a	black	brown

mit Schirm Ø 500mm, analog dimm. 1-10V
with shade Ø 500mm, analog dimm. 1-10V

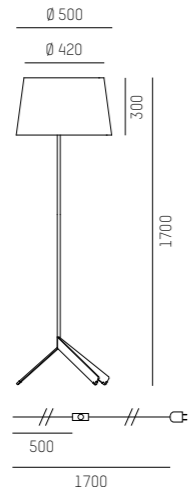

BIVIO L F

A60 ECO / E27 / max. 45W	FARBE	SCHIRM
A60 ECO / E27 / max. 45W	COLOUR	SHADE
645-10606000012a	black	grey
645-10606000023a	black	brown

mit Schirm Ø 530mm, analog dimm. 1-10V
with shade Ø 530mm, analog dimm. 1-10V

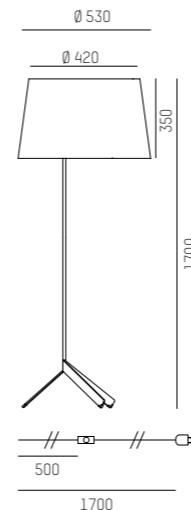

Technical data and energy efficiency



BIVIO F

YIRA PD

Design: INHOUSE

220-240V AC 50/60Hz CRI>90 / 3000K

LED Hängeleuchte aus Aluminium · Oberfläche pulverbeschichtet · in 3 Farben erhältlich · schaltbar und DALI dimmbar

LED suspension in aluminium · surface powder-coated · available in 3 colours · switchable or DALI dimmable

Sospensione LED in alluminio · superficie verniciata a polvere · disponibile in 3 colori · on off o dimmerabile DALI

Suspension LED en aluminium · surface thermolaquée · disponible en 3 couleurs · on/off ou dimmable DALI

SYS 6W	FARBE	LM
SYS 6W	COLOUR	LM
188-202000012922Y	terra	380
188-202000012955Y	white	380
188-202000012966Y	black	380

Ausstrahlwinkel: 60° / beam angle: 60°

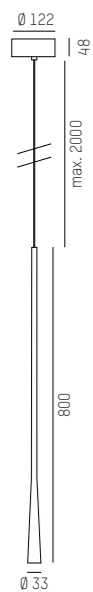

IP20

COMPLETE CODE

Y = DIMMABLE

- switchable = 0
- DALI dimm. = d





FIUME PD Design: Rainer Mutsch
220-240V AC 50/60Hz

LED Pendelleuchte aus Gips mit organisch fließender Formgebung ·
Dezentes Kabel in den Farben der Leuchte Schwarz oder Weiß

LED pendant luminaire made of plaster with organic flowing design · very
discreet cable in the colours of the luminaire black or white

Lampada LED a sospensione in gesso dalla forma organica in movimento ·
cavo molto discreto disponibile in bianco o nero

Lampe LED suspendue en plâtre avec une forme organique en mouve-
ment · câble très discret disponible en noir ou en blanc

LED 6W	LM
184-2020000WWXXY	280

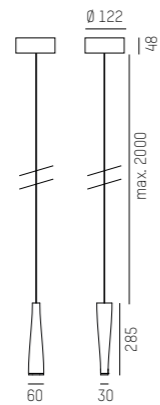

FIUME PD

IP20

COMPLETE CODE		
WW = LIGHT COLOUR	XX = COLOUR LUMINAIRE	Y = DIMMBAR / DIMMABLE
W2 LED 2700K = 23 CRI>90	W white = 55	S switchable = 0
W3 LED 3000K = 29 CRI>90	S black = 66	D DALI dimm. = d

Technical data and energy efficiency



FIUME PD

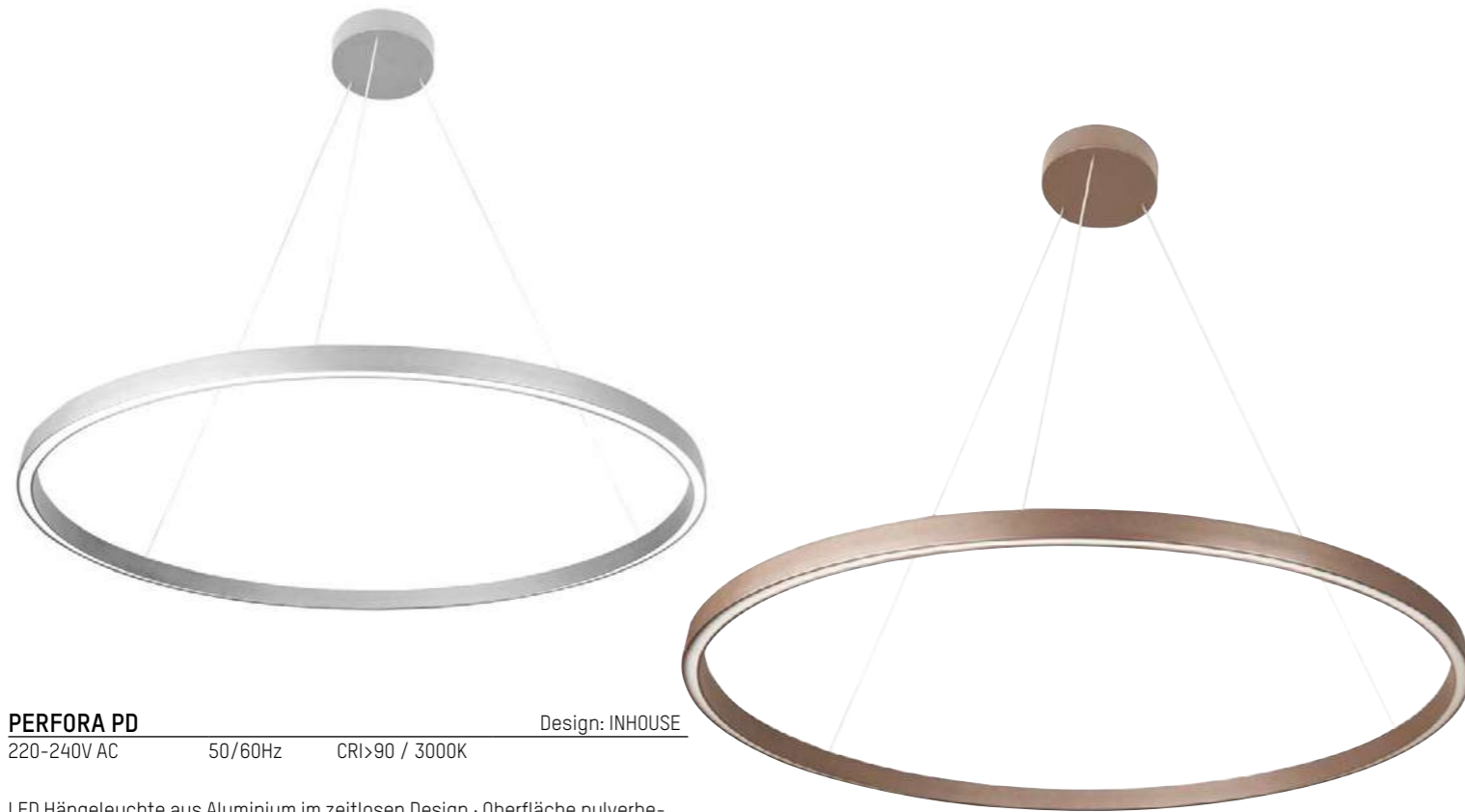

PERFORA PD Design: INHOUSE
220-240V AC 50/60Hz CRI>90 / 3000K

LED Hängeleuchte aus Aluminium im zeitlosen Design · Oberfläche pulverbeschichtet · in 3 Farben erhältlich · schaltbar

LED suspension in aluminium in a timeless design · powder-coated surface · available in 3 colours · switchable

Sospensione LED in alluminio da design · superficie verniciata a polvere · disponibile in 3 colori · on/off

Suspension LED en aluminium au design intemporel · surface thermolaquée · disponible en 3 couleurs · on/off

PERFORA M PD

SYS 34W	FARBE	LM
SYS 34W	COLOUR	LM
472-10019200	terra	1200
472-10019500	white	1200
472-10019600	black	1200

Direkter Lichtaustritt / direct beam

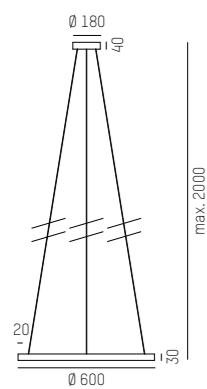

PERFORA L PD

SYS 64W	FARBE	LM
SYS 64W	COLOUR	LM
472-10029200	terra	2850
472-10029500	white	2850
472-10029600	black	2850

Direkter Lichtaustritt / direct beam

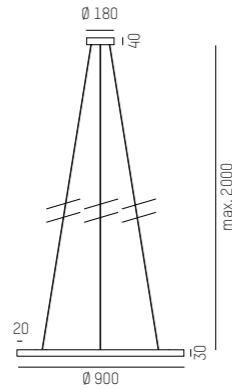

Technical data and energy efficiency



PERFORA M PD



PERFORA L PD



LASH Design: Serge & Robert Cornelissen
 220-240V AC 50/60Hz CRI>80

Organisch geformte Leuchte · Opal-Diffusor aus rotationsgegossenem Polyethylen · hochwertige Endkappen

Organic shaped LED luminaire · opal diffuser made of rotomoulded polyethylene · high quality end caps

Lampada LED, forma organica · diffusore opale in polietilene · tappo finale di alta qualità

Luminaire LED, forme organique · diffuseur opal en polyéthylène · embout en haute qualité.

LASH SD

SYS 48W	FARBE	LM
SYS 48W	COLOUR	LM
660-30	WW5YYY	opal white 5100 - 5650

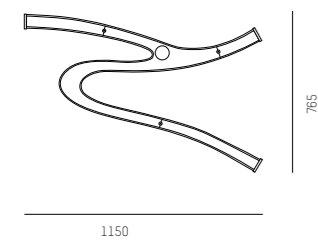

LASH PD

SYS 48W	FARBE	LM
SYS 48W	COLOUR	LM
660-10	WW5YYY	opal white 5100 - 5650

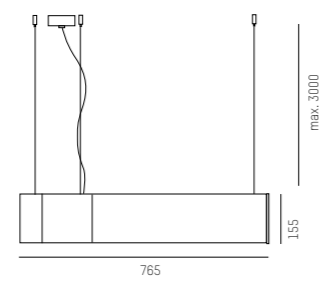
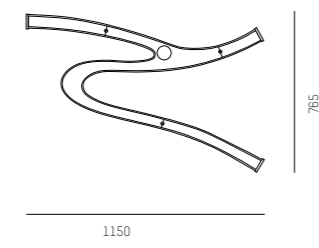

LASH OBJECT

SYS 48W	FARBE	LM
SYS 48W	COLOUR	LM
660-50	WW5d	opal white 5100 - 5650

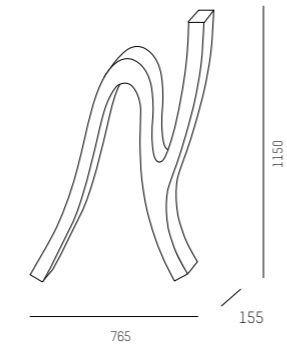

COMPLETE CODE	
W = LIGHT COLOUR	YYY = DIMMABLE
W3 LED 3000K = 19 CRI>80	Ⓢ switchable = no addition
W4 LED 4000K = 14 CRI>80	Ⓣ DALI dimm. = code + ddd



Private residence
 Austria
 Photo: Tischlerei Kotrasch

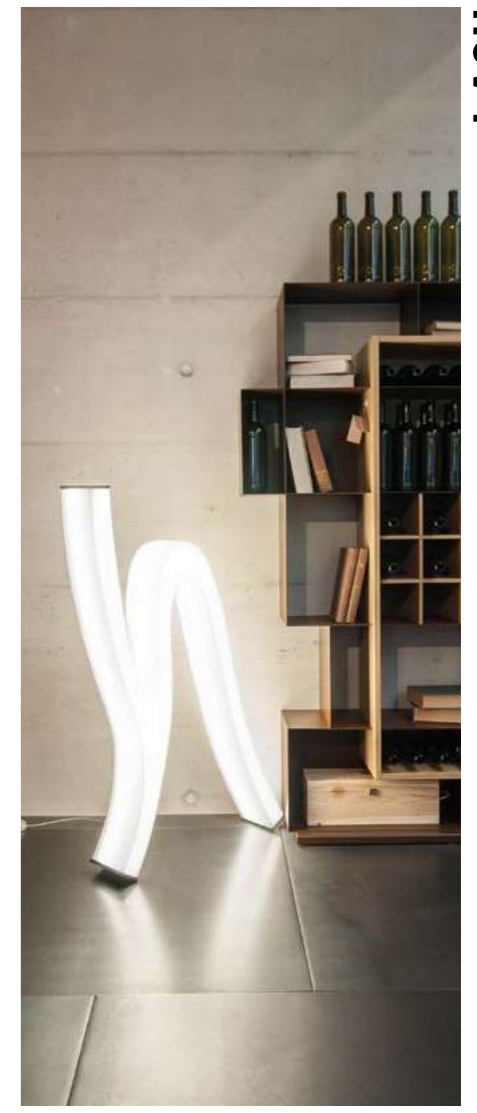

LASH



Technical data and energy efficiency

 LASH SD	 LASH PD	 LASH OBJECT
--	--	--

LASH SYSTEM SD Design: Serge & Robert Cornelissen
 220-240V AC 50/60Hz CRI>80

Organisch geformte modulare LED Aufbauleuchte · Opal-Diffusor aus rotations-
 gegossenem Polyethylen · hochwertige Endkappen (separat ordern)

Organic shaped LED modular surface mounted luminaire · opal diffuser made
 of rotomoulded polyethylene · high quality end caps (order separately)

Lampada LED a soffitto/parete modulare, forma organica · diffusore opale in
 polietilene · tappo finale di alta qualit  (ordinare separatamente)

Applique LED modulaire, forme organique · diffuseur opal en
 poly thyl ne · embout en haute qualit  (commander s par ment)

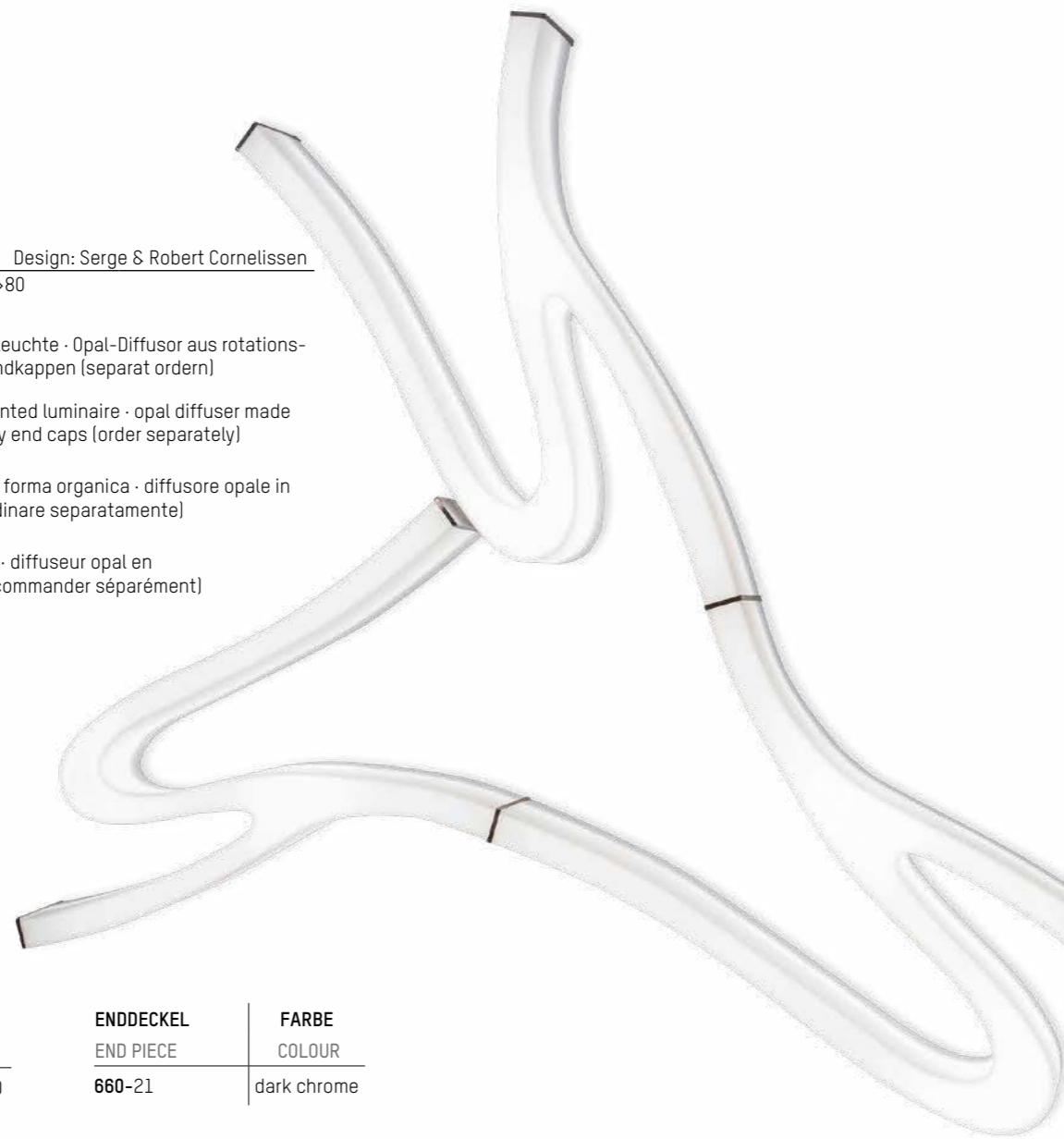

LASH SYSTEM SD

SYS 48W	FARBE	LM
SYS 48W	COLOUR	LM
660-40WW5YYY	opal white	5100 - 5650

ENDECKEL	FARBE
END PIECE	COLOUR
660-21	dark chrome

SYSTEMVERBINDER

SYSTEM JUNCTION

660-42d
 dimmbar / dimmable

EINSPEISUNG	FARBE
POWER FEED	COLOUR
660-401d	white

5 x 1,5mm², max. 10 Leuchten
 pro Einspeisung
 5 x 1,5mm², max. 10 luminaires
 per power feed

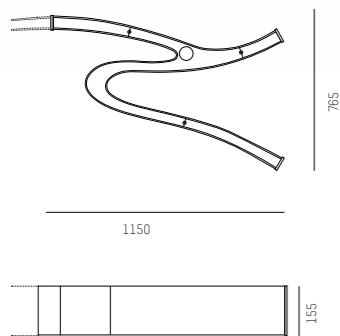

COMPLETE CODE	
W = LIGHT COLOUR	YYY = DIMMABLE
W3 LED 3000K = 19 CRI>80	Ⓢ switchable = no addition
W4 LED 4000K = 14 CRI>80	Ⓣ DALI dimm. = code + ddd

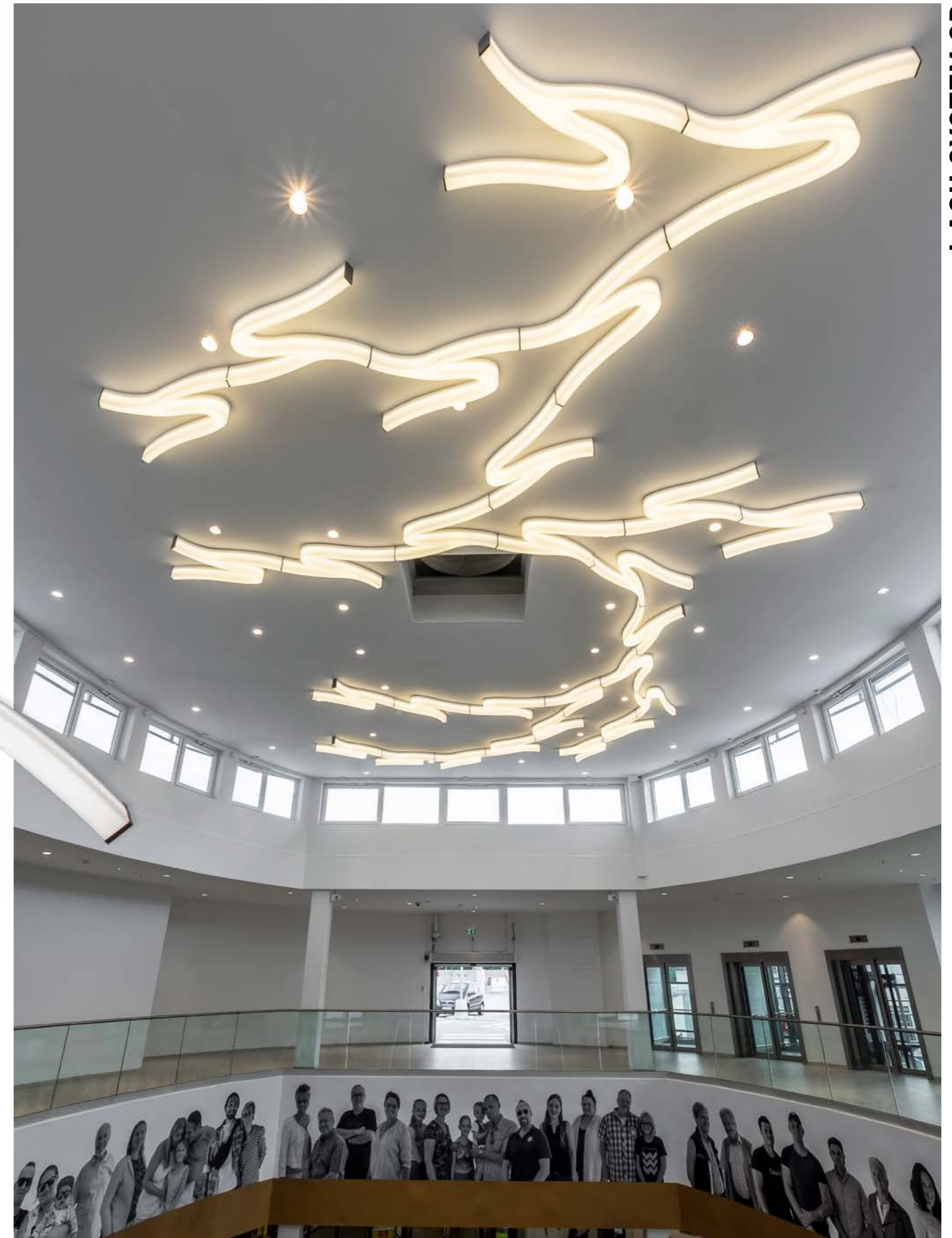

Stadtgalerie
 Velbert, Germany
 Photo: Alexander Schwarz

Technical data and energy efficiency





LASH SYSTEM PD Design: Serge & Robert Cornelissen
 220-240V AC 50/60Hz CRI>80

Organisch geformte modulare LED Pendelleuchte · Opal-Diffusor aus rotationsgegossenem Polyethylen · hochwertige Endkappen (separat ordern)

Organic shaped LED modular pendant · opal diffuser made of rotomoulded polyethylene · high quality end caps (order separately)

Lampada sospensione a LED modulare, forma organica · diffusore opale in polietilene · tappo finale di alta qualita (ordinare separatamente)

Suspension LED modulaire, forme organique · diffuseur opal en polyéthylène · embout en haute qualita (commander séparément)

LASH SYSTEM PD

SYS 48W	FARBE	LM
SYS 48W	COLOUR	LM
660-20WW5YYY	opal white	5100 - 5650

ENDECKEL	FARBE
END PIECE	COLOUR
660-21	dark chrome

SYSTEMVERBINDER

SYSTEM JUNCTION

660-22d

dimmbar / dimmable

EINSPEISUNG	FARBE	KABEL
POWER FEED	COLOUR	CABLE
581-075	white	3 x 1,5mm ²
581-076	white	5 x 1,5mm ²

max. 10 Leuchten pro Einspeisung
 max. 10 luminaires per power feed

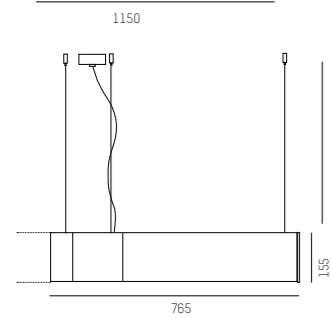
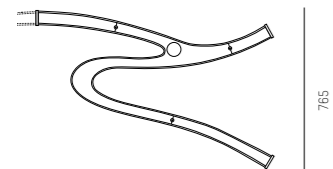

COMPLETE CODE	
W = LIGHT COLOUR	YYY = DIMMABLE
W3 LED 3000K = 19 CRI>80	Ⓢ switchable = no addition
W4 LED 4000K = 14 CRI>80	Ⓣ DALI dimm. = code + ddd

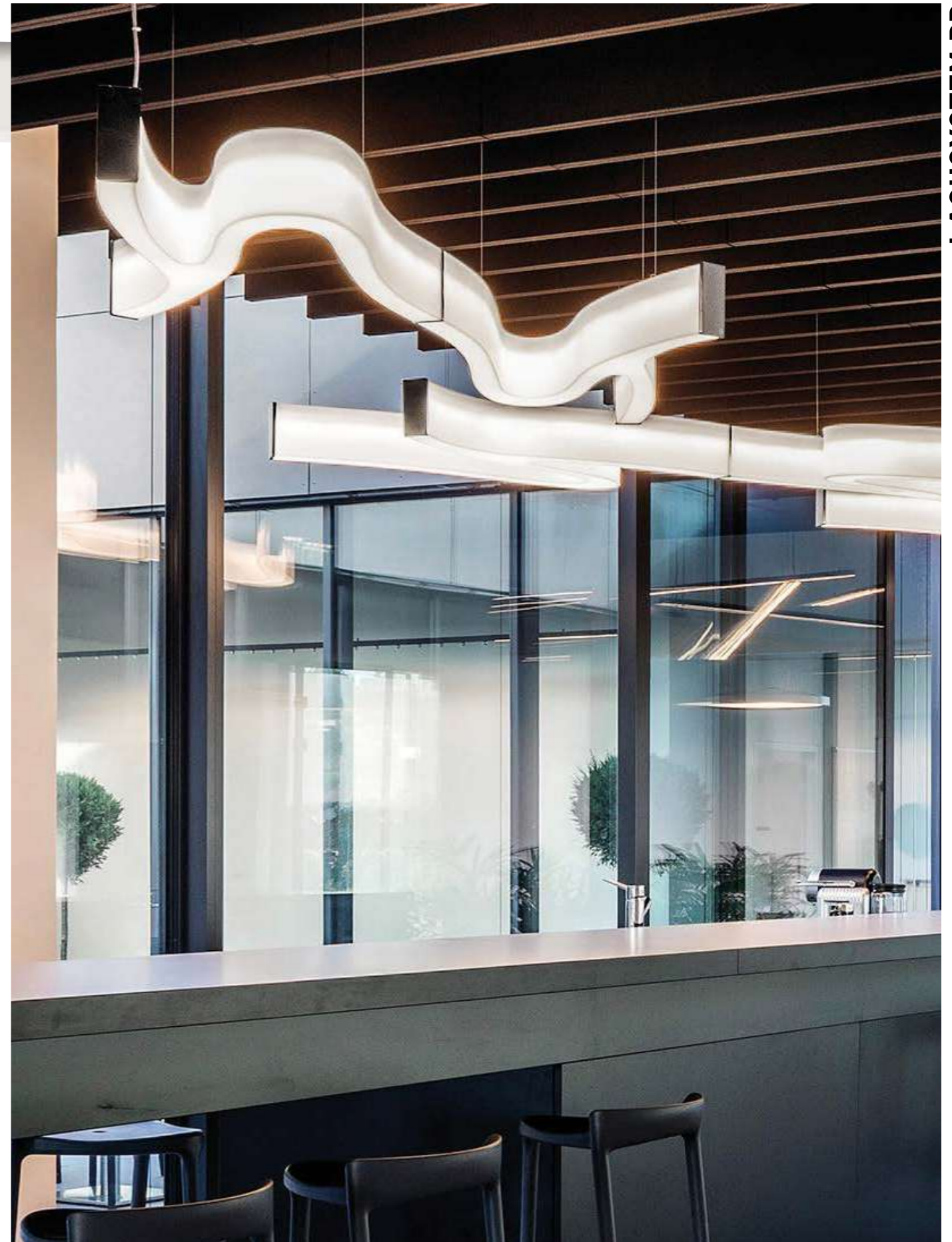

Technical data and energy efficiency





THE PERFECT VARIETY

Die variantenreiche Produktfamilie DARK NIGHT besticht durch ihre Anpassungsfähigkeit, als Downlight, schwenkbarer Downlight, Hängeleuchte mit Baldachin oder VOLARE Adapter bis zum Aufbau-downlight. Das Produkthighlight DARK NIGHT LGP eröffnet durch die separate Steuerung von diffusem und gerichtetem Licht aus einer Leuchte neue Möglichkeiten in der Inszenierung von Räumen. Die DARK NIGHT Familie ist in schwarz und weiß pulverbeschichteten Gehäusen und Reflektoren in Schwarz Hochglanz, Silber Matt, weiß und Gold erhältlich.

The varied product family DARK NIGHT impresses with its adaptability, from downlight and swivelling downlight to pendant luminaire with canopy or VOLARE adapter through to surface mounted downlight. The product highlight DARK NIGHT LGP opens up completely possibilities in the staging of rooms through the separate control of diffuse and directed light from one luminaire. The DARK NIGHT family is available in black and white powder-coated housings and reflectors in high-gloss black, matt silver, white and gold.

Design: INHOUSE

DARK NIGHT



Versions



Core Colours



Reflector Colours



Light beam

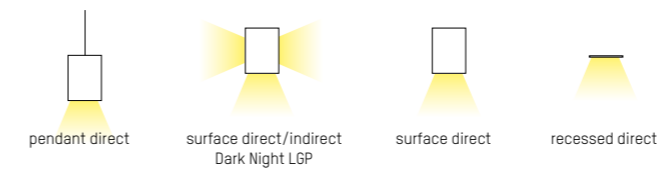

LED Colour



Specials Dark Night LGP SDI

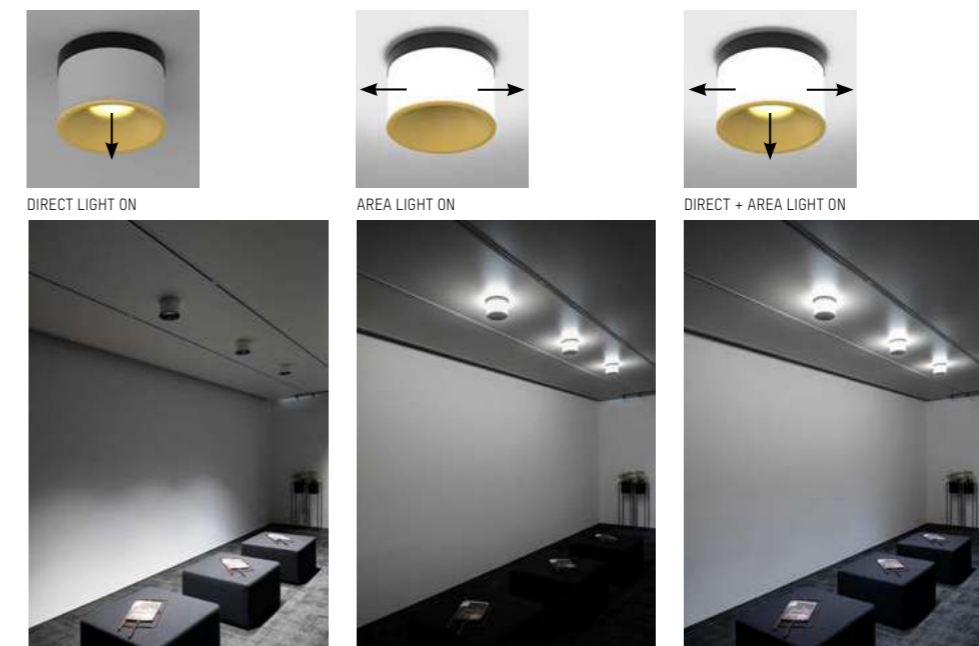

Design: INHOUSE

Information DARK NIGHT LGP





DARK NIGHT L6P SDI

Design: INHOUSE

220-240V AC 50/60Hz UGR<19

Aufbauleuchte aus Aluminium · perfekt entblendetes Direktlicht · homogen und breit abstrahlendes Indirektlicht · getrennt schalt- bzw. dimmbar

Surface mounted luminaire · perfectly glare-free direct light · homogeneous and wide beam indirect light · separately switchable and dimmable

Plafonnier en aluminium · émission lumineuse directe particulièrement · émission lumineuse indirecte homogène · contrôlables et dimmables séparément

Plafonnier en aluminium · émission lumineuse directe particulièrement · émission lumineuse indirecte homogène · contrôlables et dimmables séparément

SYS 40W	LM
706-010RR55WWXXY	3010 - 3580

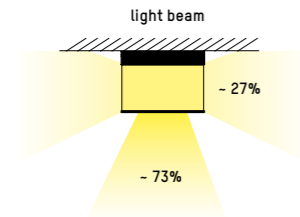
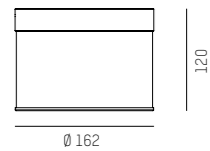

IP20

COMPLETE CODE			
RR = REFLECTOR	WW = LIGHT COLOUR	XX = COLOUR	Y = DIMMABLE
S 40° medium = 02	W2 LED 2700K = 43 PREMIUM CRI>90	W white = 05	S switchable = 0
S 40° medium = 03	W3 LED 3000K = 49 PREMIUM CRI>90	S black = 06	C CASAMBI dimm. = c
B 40° medium = 04	W4 LED 4000K = 24 CRI>90		D DALI dimm. = d
W 40° medium = 06			Z ZIGBEE dimm. = z



Carpe Diem
Linz, Austria
Photo: Joachim Rauch

Technical data and energy efficiency





DARK NIGHT TURN SD

Design: INHOUSE

220-240V AC 50/60Hz UGR<16

LED Deckenaufbauleuchte rund aus Aluminium · Oberfläche pulverbeschichtet · in 2 Farben erhältlich · perfekte Entblendung durch zurückversetzte Linsenoptik · schwenkbar

Round LED surface mounted ceiling luminaire in aluminium · surface powder-coated · available in 2 colours · perfect glare control due to recessed lens optics · swivelling

Lampada LED a plafone rotonda in alluminio · superficie verniciata a polvere · disponibile in 2 colori · perfetto controllo dell'abbagliamento grazie all'ottica retrocessa · girevole

Plafonnier rond LED en aluminium · surface thermolaquée · disponible en 2 couleurs · anti-éblouissement parfait grâce à la lentille en retrait · pivotant

DARK NIGHT TURN XS SD

SYS 9W	LM
527-0009RR03WWXX0	600

nicht dimmbar / not dimmable

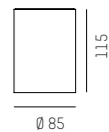

DARK NIGHT TURN S SD

SYS 13W	LM
527-0010RR03WWXXY	810

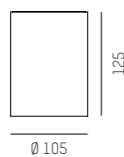

IP20

COMPLETE CODE			
RR = REFLECTOR	WW = LIGHT COLOUR	XX = COLOUR	Y = DIMMABLE
S = 02 40° medium	W2 LED 2700K = 43 PREMIUM CRI>90	W white = 05	S switchable = 0
S = 03 40° medium	W3 LED 3000K = 49 PREMIUM CRI>90	S black = 06	D DALI dimm. = d
B = 04 40° medium	W4 LED 4000K = 24 CRI>90		
W = 06 40° medium			

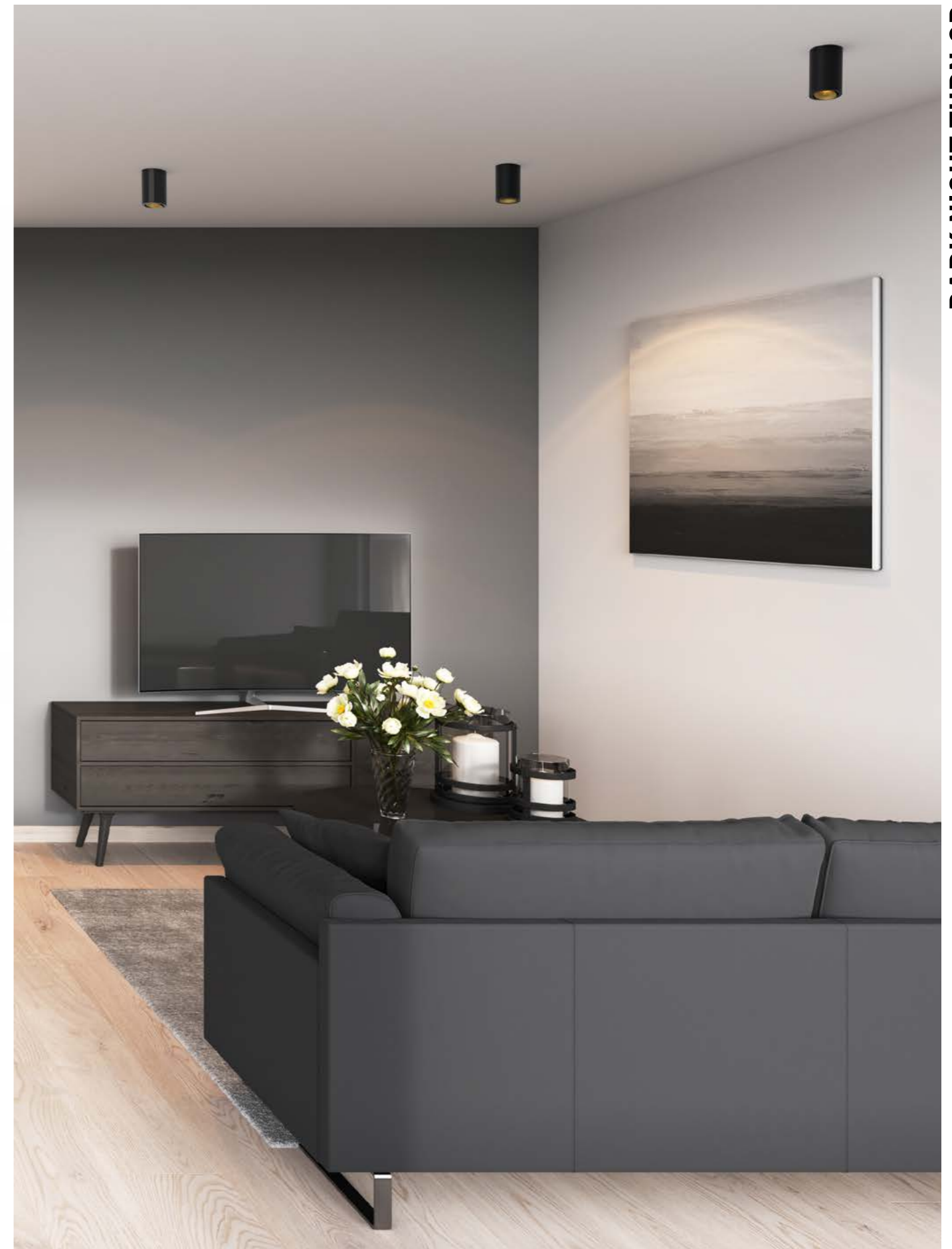

Technical data and energy efficiency



DARK NIGHT TURN XS SD



DARK NIGHT TURN S SD



DARK NIGHT XS PD Design: INHOUSE
 220-240V AC 50/60Hz UGR<19

Pendelleuchte aus Aluminium · Oberfläche pulverbeschichtet · perfekte Entblendung durch zurückversetztem Reflektor

Pendant in aluminium · surface powder-coated · perfect glare control due to recessed reflector

Sospensione in alluminio · superficie verniciata a polveri · controllo anti-abbagliamento grazie al riflettore retrocesso

Suspension en aluminium · surface laquée en poudre · contrôle anti-éblouissement grâce à un réflecteur rétro-réfléchissant

SYS 20W	LM
684-006RR05WWXXYv1	1420 - 1740

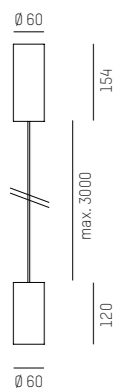

IP20 Ⓢ CE

COMPLETE CODE			
RR = REFLECTOR	WW = LIGHT COLOUR	XX = COLOUR	Y = DIMMABLE
☐ s 40° medium = 02	☐ w2 LED 2700K = 43 PREMIUM CRI>90	☐ w white = 55	☐ s switchable = 0
☐ s 40° medium = 03	☐ w3 LED 3000K = 49 PREMIUM CRI>90	☐ s black = 66	☐ d DALI dimm. = d
☐ b 40° medium = 04	☐ w4 LED 4000K = 24 CRI>90		
☐ w 40° medium = 06			

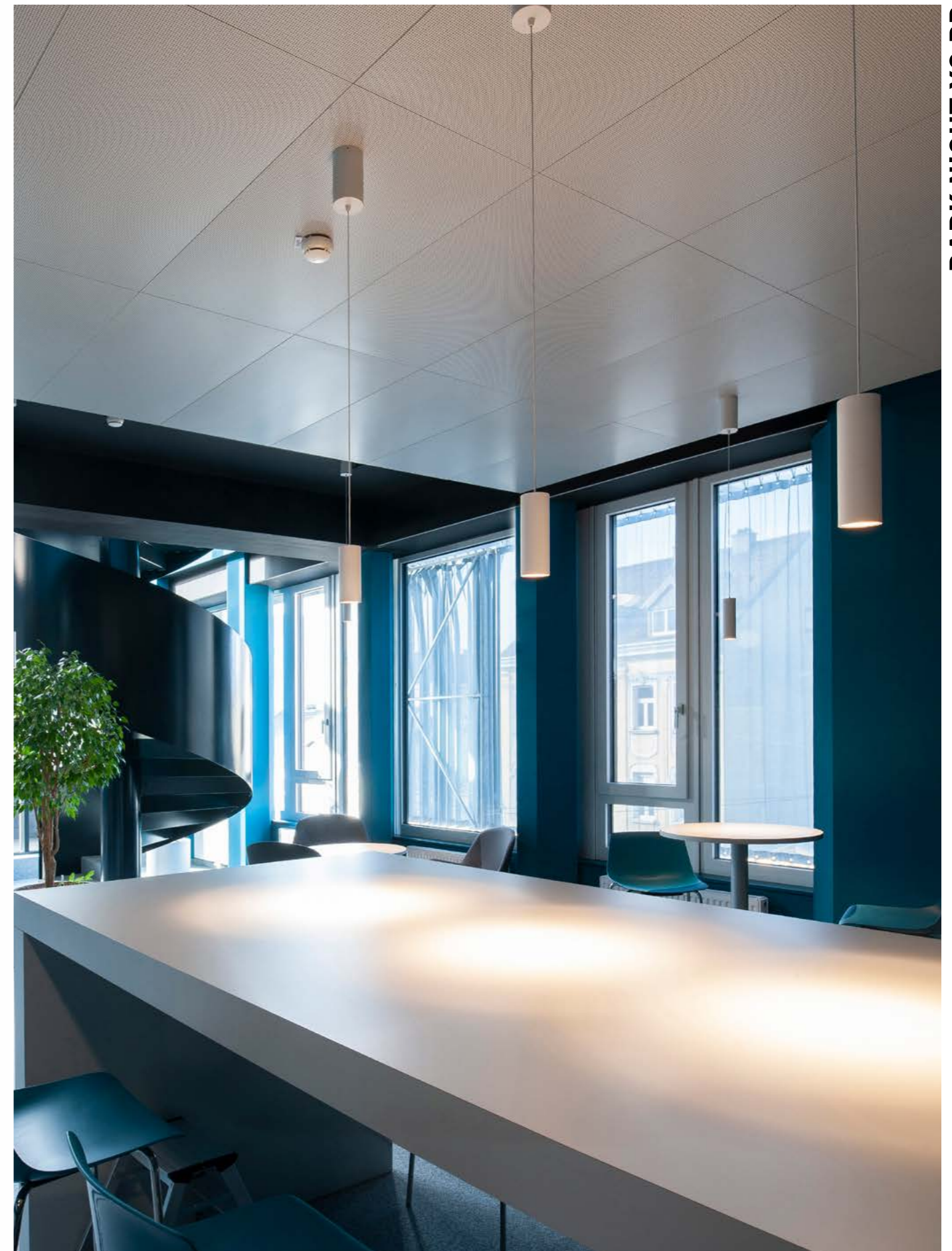

DARK NIGHT XS PD

Technical data and energy efficiency



BFI
 Linz, Austria
 Photo: Joachim Rauch

DARK NIGHT XS PD



DARK NIGHT TURN R Design: INHOUSE
UGR<19 (Dark Night XS) / UGR<16 (Dark Night SMALL)

Downlight aus Aluminium · Oberfläche pulverbeschichtet · perfekte Entblendung durch zurückversetztem Reflektor · exkl. Konverter

Downlight in aluminium · surface powder-coated · perfect glare control due to recessed reflector · excl. driver

Proiettore ad incasso · superficie verniciata a polveri · controllo anti-abbagliamento grazie al riflettore retrocesso · excl. driver

Downlight · surface laquée en poudre · contrôle anti-éblouissement grâce à un réflecteur rétro-réfléchissant · excl. convertisseur

DARK NIGHT TURN XS R

LED 9W - 250mA	LM
LED 13W - 350mA	
684-004RR05WWXXv1	780 - 1280

DARK NIGHT TURN SMALL R

LED 13W - 350mA	LM
LED 19W - 500mA	
684-005RR05WWXXv1	1000 - 1680

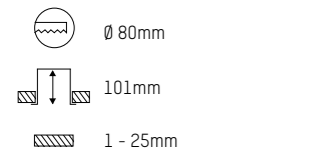
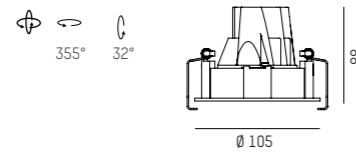
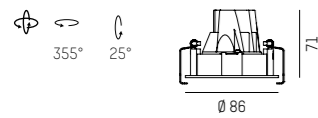

LED CONVERTER	mA	DIMM	FOR
24-127570	250	not dimmable	1 x DARK NIGHT 9W
24-127530n	350	not dimmable	1 x DARK NIGHT 13W
24-127532n	500	not dimmable	1 x DARK NIGHT 19W
24-151403	250 - 500	DALI dimmable	1 x DARK NIGHT 9 - 19W

IP20

COMPLETE CODE		
RR = REFLECTOR	WW = LIGHT COLOUR	XX = COLOUR
40° medium = 02	LED 2700K = 43 PREMIUM CRI>90	white = 05
40° medium = 03	LED 3000K = 49 PREMIUM CRI>90	black = 06
40° medium = 04	LED 4000K = 24 CRI>90	
40° medium = 06		

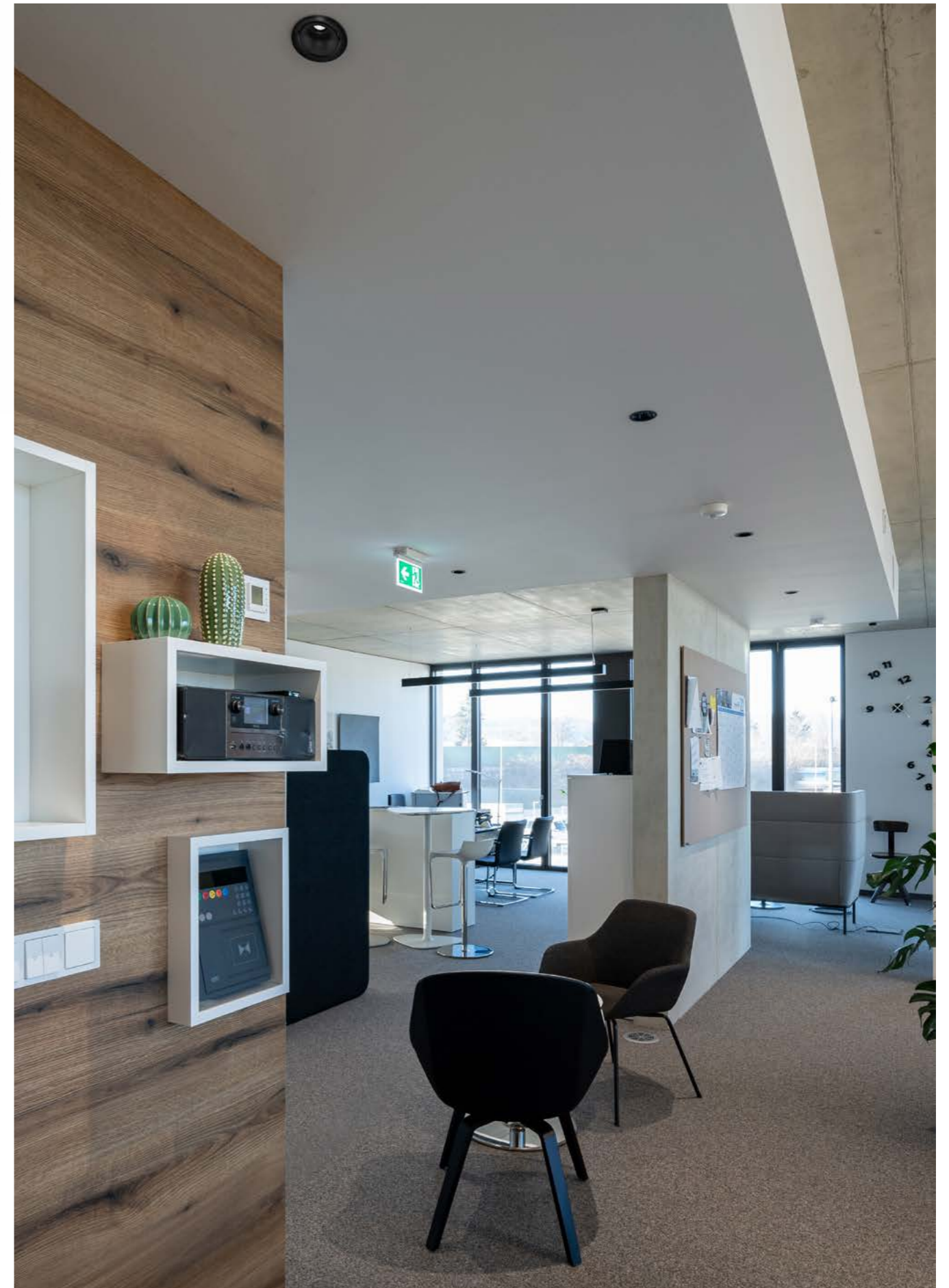

Wiesner & Hager
Graz, Austria
Photo: Joachim Rauch

Technical data and energy efficiency



DARK NIGHT TURN XS R



DARK NIGHT TURN SMALL R



DARK NIGHT R Design: INHOUSE
UGR<19 (Dark Night XS) / UGR<16 (Dark Night SMALL & DARK NIGHT MEDIUM)

Downlight aus Aluminium · Oberfläche pulverbeschichtet · perfekte Entblendung durch zurückversetztem Reflektor · excl. Konverter

Downlight in aluminium · surface powder-coated · perfect glare control due to recessed reflector · excl. driver

Proiettore ad incasso · superficie verniciata a polveri · controllo anti-abbagliamento grazie al riflettore retrocesso · excl. driver

Downlight · surface laquée en poudre · contrôle anti-éblouissement grâce à un réflecteur rétro-réfléchissant · excl. convertisseur

DARK NIGHT XS R

LED 9W - 250mA	LM
LED 13W - 350mA	
684-003RR05WWXXv1	780 - 1280

DARK NIGHT SMALL R

LED 13W - 350mA	LM
LED 19W - 500mA	
684-001RR05WWXXv1	1000 - 1680

DARK NIGHT MEDIUM R

LED 18W - 500mA	LM
LED 25W - 700mA	
LED 33W - 900mA	
684-002RR05WWXXv1	1660 - 3380

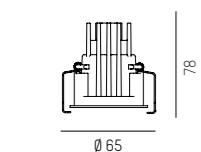

Ø 60mm
108mm
1 - 25mm

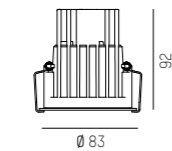

Ø 78mm
122mm
1 - 25mm

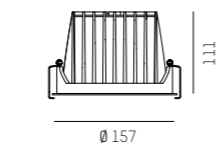

Ø 150mm
141mm
1 - 25mm

COVER RING FOR DARK NIGHT XS R

684-00XX
screwable for ceiling cutout Ø 68mm

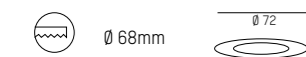

LED CONVERTER	mA	DIMM	FOR
24-127570	250	not dimmable	1 x DARK NIGHT 9W
24-127530n	350	not dimmable	1 x DARK NIGHT 13W
24-127532n	500	not dimmable	1 x DARK NIGHT 18W - 19W
24-127534n	700	not dimmable	1 x DARK NIGHT 25W
24-127536n	900	not dimmable	1 x DARK NIGHT 33W
24-151403	250 - 500	DALI dimmable	1 x DARK NIGHT 9 - 19W
24-127490	500 - 900	DALI dimmable	1 x DARK NIGHT 19 - 33W

IP20

COMPLETE CODE	RR = REFLECTOR	WW = LIGHT COLOUR	XX = COLOUR
40° medium = 02	LED 2700K = 43 PREMIUM CRI>90	white = 05	
40° medium = 03	LED 3000K = 49 PREMIUM CRI>90	black = 06	
40° medium = 04	LED 4000K = 24 CRI>90		
40° medium = 06			



DARK NIGHT R

Hopferwieser & Steinmayr
Amstetten, Austria
Photo: Joachim Rauch

Technical data and energy efficiency

DARK NIGHT XS R

DARK NIGHT SMALL R

DARK NIGHT MEDIUM R

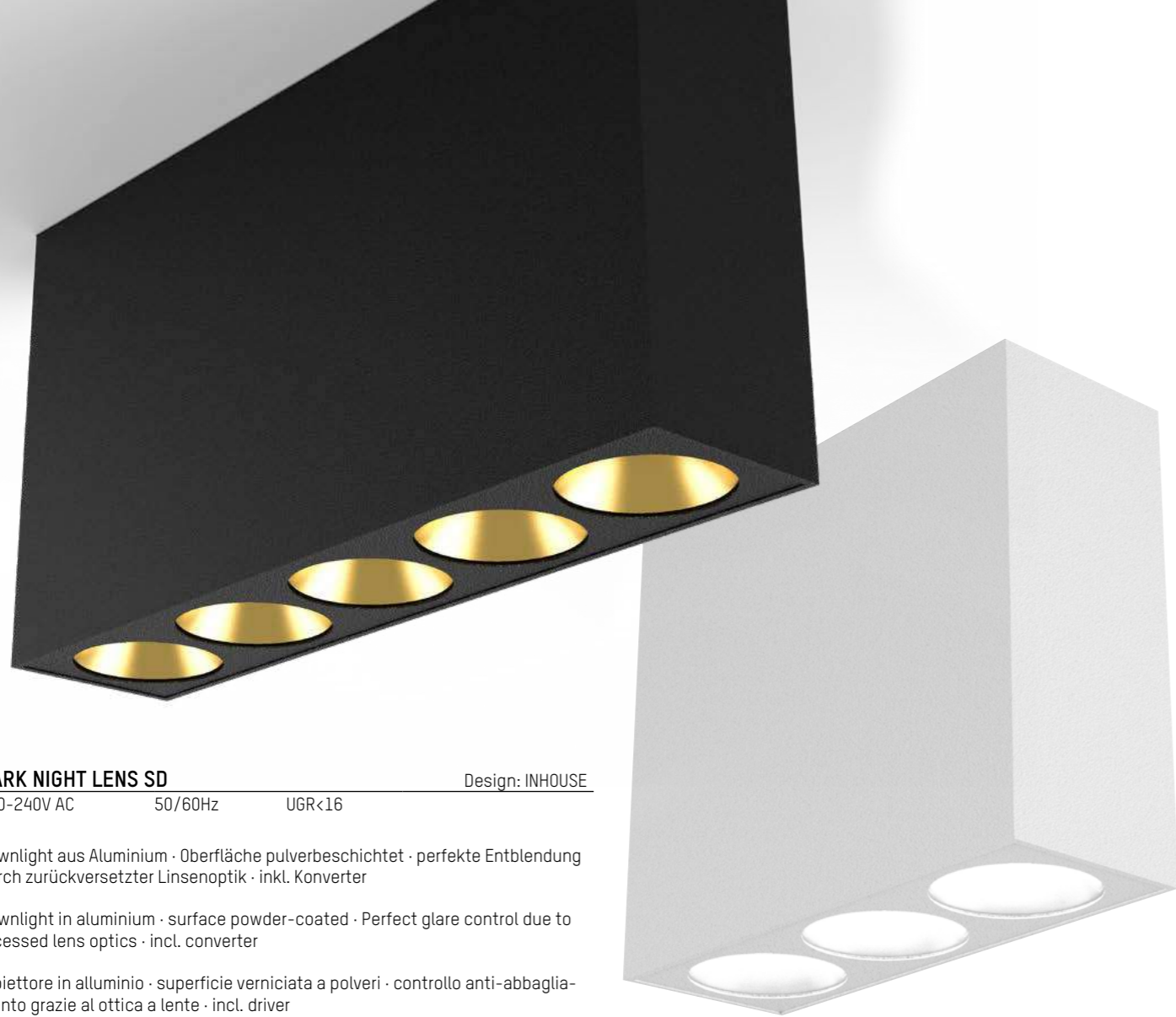

DARK NIGHT LENS SD

Design: INHOUSE

220-240V AC 50/60Hz UGR<16

Downlight aus Aluminium · Oberfläche pulverbeschichtet · perfekte Entblendung durch zurückversetzter Linsenoptik · inkl. Konverter

Downlight in aluminium · surface powder-coated · Perfect glare control due to recessed lens optics · incl. converter

Proiettore in alluminio · superficie verniciata a polveri · controllo anti-abbagliamento grazie al ottica a lente · incl. driver

Downlight en aluminium · surface laquée en poudre · contrôle anti-éblouissement grâce à un optique à lentilles rétro-réfléchissant · incl. convertisseur

DARK NIGHT LENS 3 SD

SYS 7W	LM
579-004RR0BWWXX0	450 - 580
not dimmable	

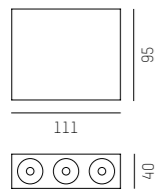

DARK NIGHT LENS 5 SD

SYS 12W	LM
579-005RR0BWWXXY	700 - 920

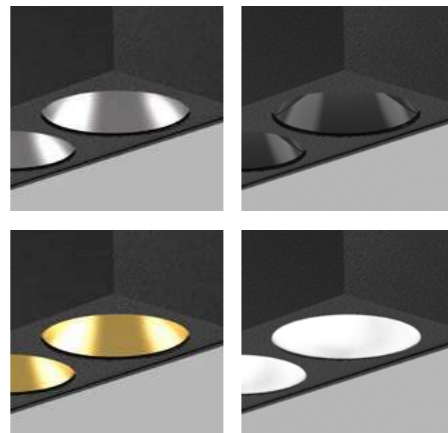
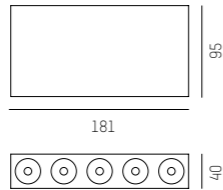

IP20 Ⓢ CE

COMPLETE CODE				
RR = REFLECTOR	B = BEAM ANGLE	WW = LIGHT COLOUR	XX = COLOUR	Y = DIMMABLE
☐ s = 02	☐ 22° = 5	☐ W2 LED 2700K = 23 CRI>90	☐ W white = 05	☐ S switchable = 0
☐ S = 03	☐ 36° = 8	☐ W3 LED 3000K = 29 CRI>90	☐ S black = 06	☐ D DALI dimm. = d
☐ B = 04		☐ W4 LED 4000K = 24 CRI>90		
☐ W = 06				



DARK NIGHT LENS SD

Technical data and energy efficiency



DARK NIGHT LENS 3 SD



DARK NIGHT LENS 5 SD

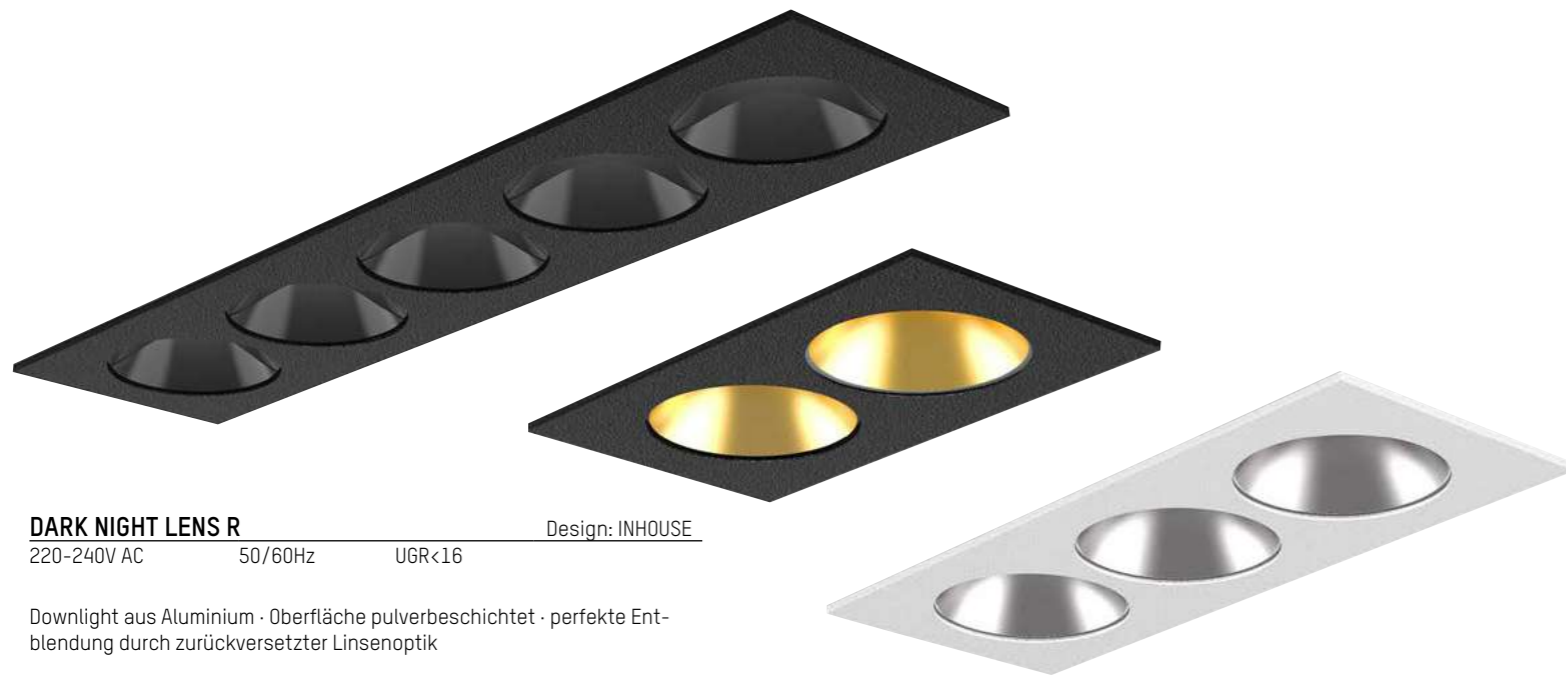

DARK NIGHT LENS R Design: INHOUSE
220-240V AC 50/60Hz UGR<16

Downlight aus Aluminium · Oberfläche pulverbeschichtet · perfekte Entblendung durch zurückversetzter Linsenoptik

Downlight in aluminium · surface powder-coated · Perfect glare control due to recessed lens optics

Proiettore in alluminio · superficie verniciata a polveri · controllo anti-abbagliamento grazie al ottica a lente

Downlight en aluminium · surface laquée en poudre · contrôle anti-éblouissement grâce à un optique à lentilles rétro-réfléchissant

DARK NIGHT LENS 2 R

LED 4W - 700mA	LM
579-001RR0BWWXX	300 - 380

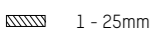
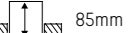
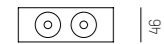
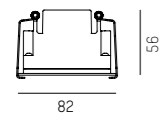

DARK NIGHT LENS 3 R

LED 6W - 700mA	LM
579-002RR0BWWXXY	450 - 580

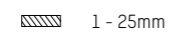
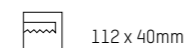
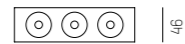
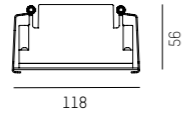

DARK NIGHT LENS 5 R

LED 10W - 700mA	LM
579-003RR0BWWXXY	700 - 920

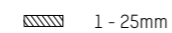
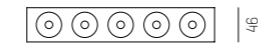
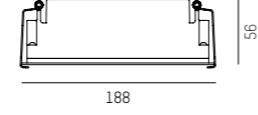

LED CONVERTER	mA	DIMM	FOR
24-122201	700	not dimmable	1 x DARK NIGHT LENS R
24-151403	700	DALI dimmable	1 x DARK NIGHT LENS R

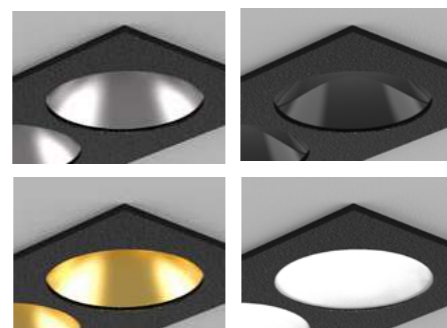

IP20

COMPLETE CODE				
RR = REFLECTOR	B = BEAM ANGLE	WW = LIGHT COLOUR	XX = COLOUR	Y = DIMMABLE
= 02	22° = 5	LED 2700K = 23 CRI>90	white = 05	switchable = 0
= 03	36° = 8	LED 3000K = 29 CRI>90	black = 06	DALI dimm. = d
= 04		LED 4000K = 24 CRI>90		
= 06				



DARK NIGHT LENS R

Technical data and energy efficiency

DARK NIGHT LENS 2 R

DARK NIGHT LENS 3 R

DARK NIGHT LENS 5 R

COZY R Design: Serge Cornelissen
 220-240V AC 50/60Hz CRI>90

Einbaudownlight aus Aluminium weiß mit 2 getrennt schaltbaren Lichtkreisen - Hauptlichtquelle für fokussiertes Licht und zweite Lichtquelle für stimmungsvolles Grundlicht - schaltbar oder DALI dimmbar

Recessed downlight in aluminium white with 2 separately switchable light circuits - main light source for focused light and second light source for atmospheric background light - switchable or DALI dimmable

Incasso in alluminio bianco con 2 accensioni separabili - illuminazione d'accento e luce diffusa - on/off o dimmerabile DALI

Downlight encastré en aluminium blanc avec 2 circuits d'éclairage commutables séparément - source lumineuse principale pour une lumière focalisée et source lumineuse secondaire pour une lumière d'ambiance on/off ou dimmable DALI



COZY R DOWNLIGHT

SYS 9W	LM
573-0100RWW00505Y	820

inkl. Konverter / incl. driver

COZY R WALLWASHER

SYS 9W	LM
573-0200RWW00505Y	820

inkl. Konverter / incl. driver

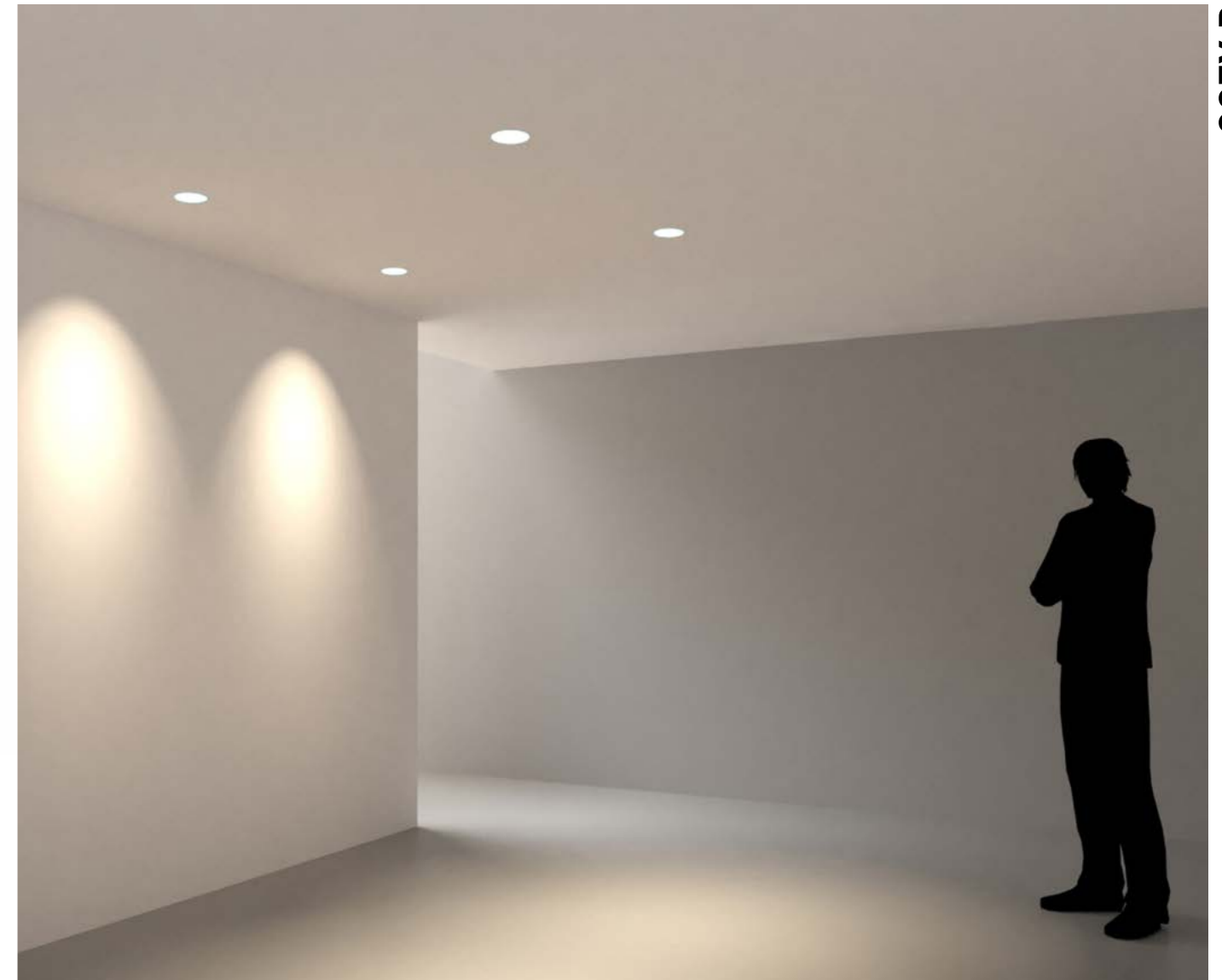
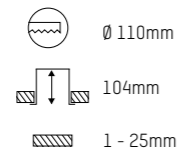
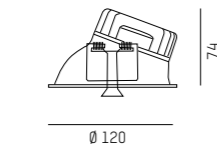
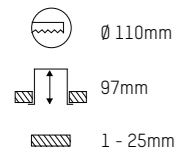
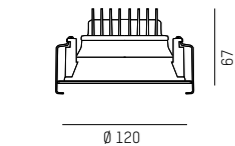

COZY R WALLWASHER
 Grundlicht und Spotlicht ein
 Groundlight and spotlight on



COZY R WALLWASHER
 Grundlicht ein
 Groundlight on



COZY R WALLWASHER
 Spotlicht ein
 Spotlight on

IP20

COMPLETE CODE		
R = REFLECTOR	WW = LIGHT COLOUR	Y = DIMMABLE
<ul style="list-style-type: none"> 24° chrome = 2 45° chrome = 3 24° dark chrome = 8 45° dark chrome = 9 	<ul style="list-style-type: none"> LED 2700K = 13 CRI>90 LED 3000K = 19 CRI>90 LED 4000K = 14 CRI>90 	<ul style="list-style-type: none"> switchable = 0 DALI dimm. = d

Technical data and energy efficiency



COZY R INFO



STYLISH ACCENTS WITH ELEGANT DESIGN

LITIN ist eine formschöne und variantenreiche Leuchtenfamilie aus Aluminium. Die Pulverbeschichtete Oberfläche ist in den Farben Schwarz und Weiß erhältlich. Mit einem Dekorring in Gold, Bronze, Weiß oder Schwarz lassen sich stilvolle Akzente setzen. Zwei unterschiedliche Ausstrahlwinkel sowie ein satiniertes bündiger Diffusor oder mit Linsenoptik schaffen ein perfektes Lichtbild. Der Leuchtenkopf ist bis zu 350° drehbar und 90° schwenkbar.

LITIN is an elegant and varied luminaire range made of aluminium. The powder-coated surface is available in black and white. A decorative ring of gold, bronze, white or black adds a stylish touch. Two different beam angles as well as a glossy flush diffuser or lens optic create the perfect brightness. The luminaire head can swivel to 350° and tilt to 90°.

Design: INHOUSE

LITIN 2



Versions

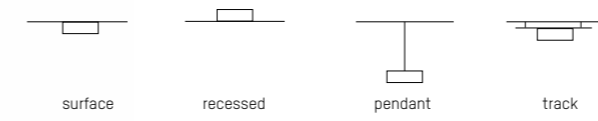

Core Colours



Creative Colours

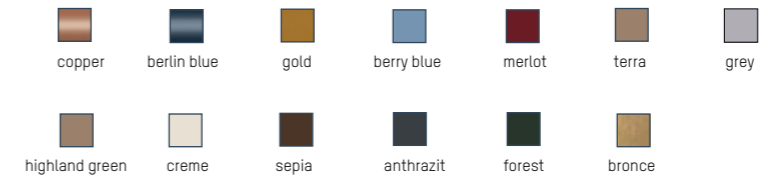

Optics

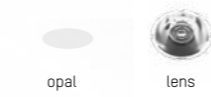

LED Colour



Design: INHOUSE

Information LITIN 2



BACK TO CONTENT



LITIN 2 TRACK Design: INHOUSE
 220-240V AC 50/60Hz CRI>90

LED Stromschienenstrahler aus Aluminium · Oberfläche pulverbeschichtet · mit satinierem bündigem Diffusor aus PMMA oder mit Linsenoptik erhältlich · Gehäuse und Dekorring in unterschiedlichen Farben

LED track spotlight in aluminium · surface powder-coated surface · available with satinied flush PMMA diffuser or with lens optics · housing and decorative ring in different colours

Proiettore LED da binario in alluminio · superficie verniciata a polvere · disponibile con diffusore a filo satinato in PMMA o con lente · corpo ed anello decorativo in diversi colori

Spot LED pour rail en aluminium · surface thermolaquée · disponible avec un diffuseur affleurant satiné en PMMA ou avec une technologie de lentille · corps et anneau décoratif disponibles en différentes couleurs

SYS 10W LM
 540-061RRWWDDXXXO 530 - 840

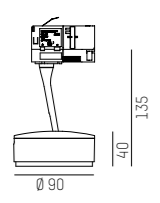

IP20 CE

COMPLETE CODE			
RR = REFLECTOR	WW = LIGHT COLOUR	DD = DECORRING COLOUR	XXX = COLOUR LUMINAIRE
<ul style="list-style-type: none"> ☐ opal diffusor = 10 ☐ 24° medium lens = 22 ☐ 40° flood lens = 23 	<ul style="list-style-type: none"> W2 LED 2700K = 13 CRI>90 W3 LED 3000K = 19 CRI>90 W4 LED 4000K = 14 CRI>90 	<ul style="list-style-type: none"> W white = 05 S black = 06 G gold = 1d K copper = 1b 	<ul style="list-style-type: none"> W white = 505 S black = 606

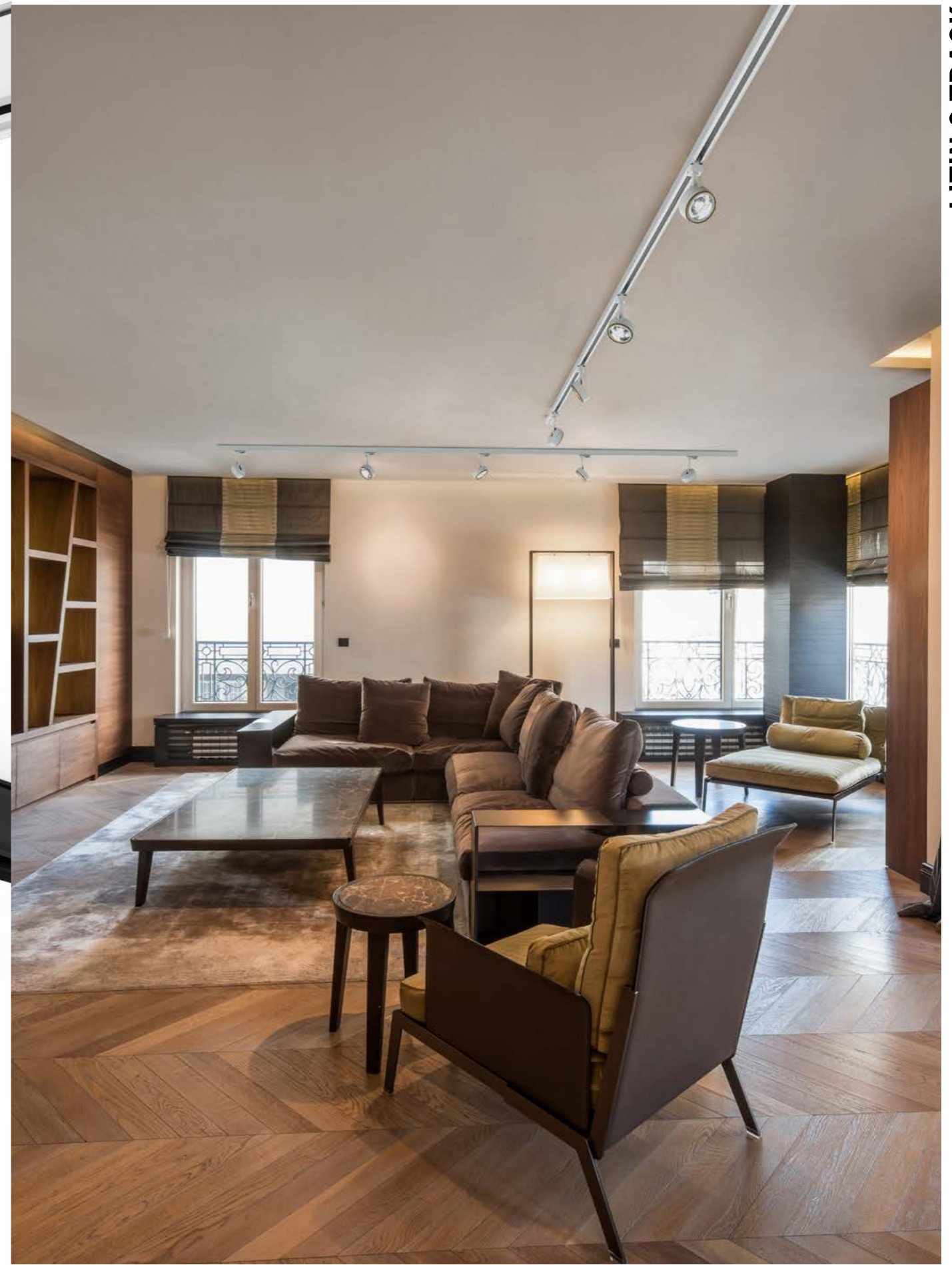

LITIN 2 TRACK

Technical data and energy efficiency



LITIN 2 TRACK



LITIN 2 PD Design: INHOUSE
 220-240V AC 50/60Hz CRI>90

LED Pendelleuchte aus Aluminium · Oberfläche pulverbeschichtet · mit satiniertem bündigem Diffusor aus PMMA oder mit Linsenoptik erhältlich · Gehäuse und Dekorring in unterschiedlichen Farben

LED pendant in aluminium · surface powder-coated surface · available with satined flush PMMA diffuser or with lens optics · housing and decorative ring in different colours

Sospensione LED in alluminio · superficie verniciata a polvere · disponibile con diffusore a filo satinato in PMMA o con lente · corpo ed anello decorativo in diversi colori

Suspension LED en aluminium · surface thermolaquée · disponible avec un diffuseur affleurant satiné en PMMA ou avec une technologie de lentille · corps et anneau décoratif disponibles en différentes couleurs

SYS 10W LM
 540-041RRWWDDXXX0 530 - 840

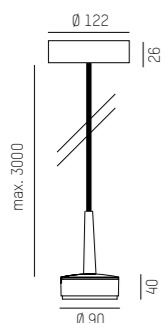

IP20

COMPLETE CODE			
RR = REFLECTOR	WW = LIGHT COLOUR	DD = DECORRING COLOUR	XXX = COLOUR LUMINAIRE
opal diffuser = 10	LED 2700K = 13 CRI>90	white = 05	white = 505
24° medium lens = 22	LED 3000K = 19 CRI>90	black = 06	black = 606
40° flood lens = 23	LED 4000K = 14 CRI>90	gold = 1d	
		copper = 1b	



Technical data and energy efficiency





LITIN 2 SD Design: INHOUSE
 220-240V AC 50/60Hz CRI>90

LED Deckenaufbauleuchte aus Aluminium · Oberfläche pulverbeschichtet · mit satinierem bündigem Diffusor aus PMMA oder mit Linsenoptik erhältlich · Gehäuse und Dekorring in unterschiedlichen Farben

LED surface mounted ceiling luminaire in aluminium · surface powder-coated surface · available with satined flush PMMA diffuser or with lens optics · housing and decorative ring in different colours

Lampada LED a plafone in alluminio · superficie verniciata a polvere · disponibile con diffusore a filo satinato in PMMA o con lente · corpo ed anello decorativo in diversi colori

Plafonnier LED en aluminium · surface thermolaquée · disponible avec un diffuseur affleurant satiné en PMMA ou avec une technologie de lentille · corps et anneau décoratif disponibles en différentes couleurs

SYS 10W LM
 540-011RRWWDDXXXO 530 - 840

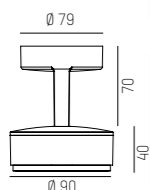
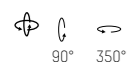

IP20

COMPLETE CODE			
RR = REFLECTOR	WW = LIGHT COLOUR	DD = DECORRING COLOUR	XXX = COLOUR LUMINAIRE
opal diffusor = 10	LED 2700K = 13 CRI>90	white = 05	white = 505
24° medium lens = 22	LED 3000K = 19 CRI>90	black = 06	black = 606
40° flood lens = 23	LED 4000K = 14 CRI>90	gold = 1d	
		copper = 1b	



Technical data and energy efficiency



LITIN 2 R

Design: INHOUSE

220-240V AC 50/60Hz CRI>90

LED Deckeneinbauleuchte aus Aluminium · Oberfläche pulverbeschichtet · mit satinierem bündigem Diffusor aus PMMA oder mit Linsenoptik erhältlich · Gehäuse und Dekorring in unterschiedlichen Farben

LED recessed ceiling luminaire in aluminium · surface powder-coated surface · available with satinied flush PMMA diffuser or with lens optics · housing and decorative ring in different colours

Lampada LED ad incasso in alluminio · superficie verniciata a polvere · disponibile con diffusore a filo satinato in PMMA o con lente · corpo ed anello decorativo in diversi colori

Luminaire LED encastré pour plafond en aluminium · surface thermolaquée · disponible avec un diffuseur affleurant satiné en PMMA ou avec une technologie de lentille · corps et anneau décoratif disponibles en différentes couleurs



SYS 10W	LM
540-071RRWWDDXXX0	530 - 840

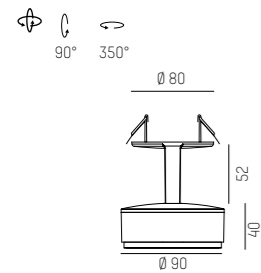

Ø 68mm

45mm

1 - 25mm

IP20



COMPLETE CODE			
RR = REFLECTOR	WW = LIGHT COLOUR	DD = DECORRING COLOUR	XXX = COLOUR LUMINAIRE
opal diffusor = 10	LED 2700K = 13 CRI>90	white = 05	white = 505
24° medium lens = 22	LED 3000K = 19 CRI>90	black = 06	black = 606
40° flood lens = 23	LED 4000K = 14 CRI>90	gold = 1d	
		copper = 1b	

492



LITIN 2 R

Technical data and energy efficiency



LITIN 2 R

493

BACK TO CONTENT



ROUND VARIETY

Die TURN ON Familie ist in 4 verschiedenen Größen und als Pendel- Deckenaufbau- oder Wandleuchte verfügbar. Die flache Leuchtenhöhe von nur 6cm wird durch einen LGP-Diffusor (Light Guide Plate) möglich. Die Lichtquelle sitzt dabei am Rand der Leuchte und bewirkt so eine sehr homogene und sanfte Ausleuchtung. Die unterschiedlichen Varianten von TURN ON schaffen eine perfekte Lichtwirkung. Gehäuse und Dekorring können farblich individuell angepasst werden.

The TURN ON family is available in four different sizes and as a pendant, surface-mounted or wall-mounted luminaire. The slim depth of only 6cm is enabled by an LGP diffuser (Light Guide Plate). This allows the light source to sit at the edge of the luminaire, effecting a very homogeneous and soft illumination. The different variants of TURN ON create a perfect lighting effect. The colour of the cover and decorative ring can be customised to your wishes.

Design: INHOUSE

TURN ON 2



Versions

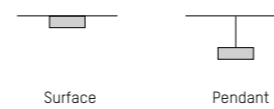

Form & Size

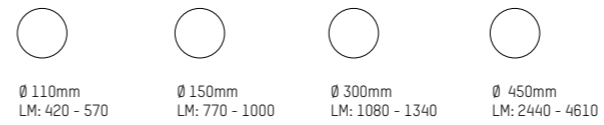

Core Colours

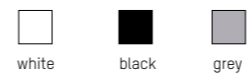

Creative Colours

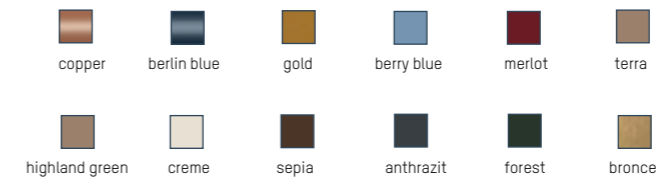

Light beam

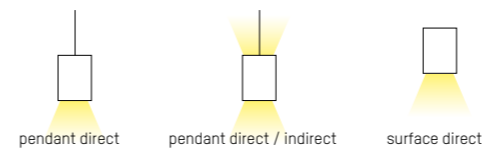

LED Colour



Specials

**DIM2
WARM**
dim2warm
Ø 150, 300 & 450 versions

Design: INHOUSE

Information TURN ON 2





TURN ON 2 SD Design: INHOUSE
220-240V AC 50/60Hz CRI>90

LED Deckenaufbauleuchte aus Aluminium · Oberfläche pulverbeschichtet · in unterschiedlichen Farben erhältlich · schaltbar oder DALI dimmbar

LED surface mounted ceiling luminaire in aluminium · surface powder-coated · available in different colours · switchable or DALI dimmable

Lampada a plafone in alluminio · superficie verniciata a polvere · disponibile in diversi colori · on/off o dimmerabile DALI

Plafonnier LED en aluminium · surface thermolaquée · disponible en différentes couleurs · on/off ou dimmable DALI

SYS 8W	Ø: 110mm	LM	SYS 12W	Ø: 150mm	LM
583-011111WWXXDD00Y		420 - 570	583-011211WWXXDD00Y		770 - 1000
SYS 14W	Ø: 300mm	LM	SYS 31W	Ø: 450mm	LM
583-011311WWXXDD00Y		1080 - 1340	583-011411WWXXDD00Y		2440 - 3020

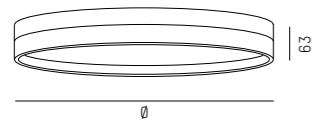

IP20 CE



COMPLETE CODE			
WW = LIGHT COLOUR	XX = BODY COLOUR	DD = DECORRING COLOUR	Y = DIMMABLE
W2 LED 2700K = 23 CRI>90	G grey = 04	G grey = 04	S switchable = 0
W3 LED 3000K = 29 CRI>90	W white = 05	W white = 05	D DALI dimm. = d
W4 LED 4000K = 24 CRI>90	S black = 06	S black = 06	
		G gold = 1d	

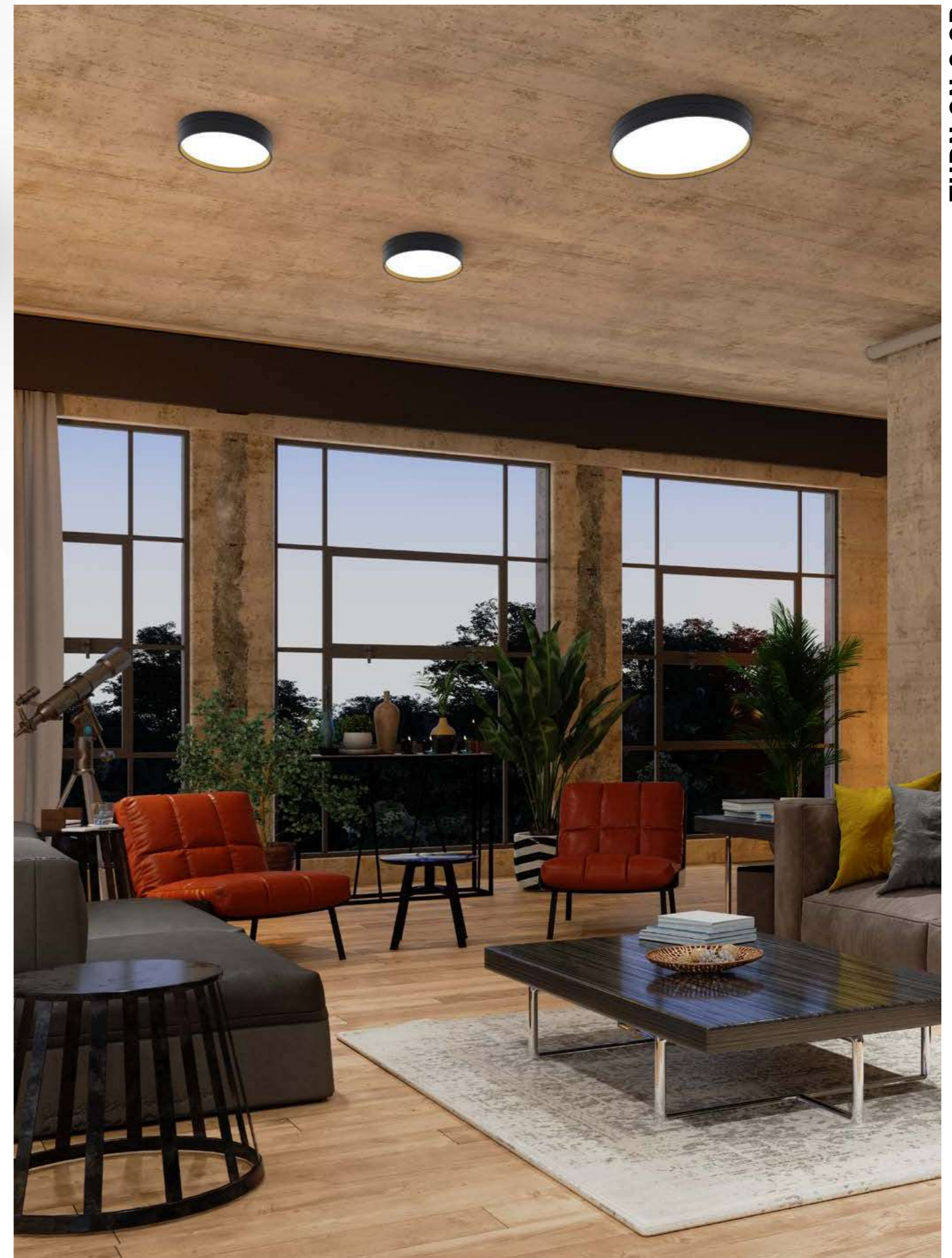

Technical data and energy efficiency





TURN ON 2 PD/PDI Design: INHOUSE
 220-240V AC 50/60Hz CRI>90

LED Pendelleuchte aus Aluminium · Oberfläche pulverbeschichtet · in unterschiedlichen Farben erhältlich · schaltbar oder DALI dimmbar

LED pendant in aluminium · surface powder-coated · available in different colours · switchable or DALI dimmable

Sospensione LED in alluminio · superficie verniciata a polvere · disponibile in diversi colori · on/off o dimmerabile DALI

Suspension LED en aluminium · surface thermolaquée · disponible en différentes couleurs · on/off ou dimmable DALI

TURN ON 2 PD

SYS 31W Ø: 450mm LM
 583-021411WWXXDDCCY 2440 - 3020

TURN ON 2 PDI

SYS 44W Ø: 450mm LM
 583-021421WWXXDDCCY 3880-4610

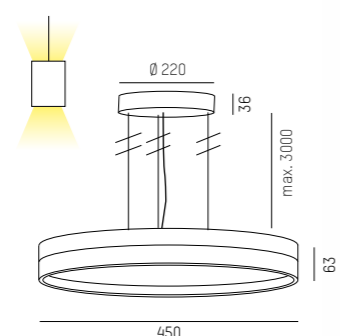
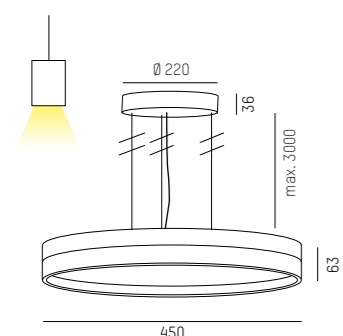

IP20 CE



COMPLETE CODE				
WW = LIGHT COLOUR	XX = BODY COLOUR	DD = DECORRING COLOUR	CC = CEILING BASE COLOUR	Y = DIMMABLE
W2 LED 2700K = 23 CRI>90	G grey = 04	G grey = 04	G grey = 04	S switchable = 0
W3 LED 3000K = 29 CRI>90	W white = 05	W white = 05	W white = 05	D DALI dimm. = d
W4 LED 4000K = 24 CRI>90	S black = 06	S black = 06	S black = 06	
		G gold = 1d		



Technical data and energy efficiency



TURN ON 2 PD



TURN ON 2 PDI



TUPAQ SD Design: Serge Cornelissen

220-240V AC 50/60Hz

Decken-/ Wandleuchte mit aus Aluminium zwei E27 Fassungen · Oberfläche pulverbeschichtet · Dekorplatte in unterschiedlichen Farben erhältlich

Wall/ceiling luminaire in aluminium with 2 sockets E27 · powder-coated surface · decor panel available in different colours

Lampada da parete / soffitto in alluminio con 2 portalampada E27 · superficie verniciata a polvere · pannello decorativo disponibile in diversi colori

Luminaire en saillie pour plafond et mur en aluminium avec deux douilles E27 · surface thermolaquée · panneau décoratif flexible disponible en différentes couleurs

AGL A60 / E27 / max. 45W	FARBE	DEKORPLATTE
AGL A60 / E27 / max. 45W	COLOUR	DECOR PLATE
116-0111001000500	white	white
116-0111002000500	white	black
116-0111003000500	white	gold
116-0111004000500	white	highlandgreen
116-0111005000500	white	copper
116-0111001000600	black	white
116-0111002000600	black	black
116-0111003000600	black	gold
116-0111004000600	black	highlandgreen
116-0111005000600	black	copper

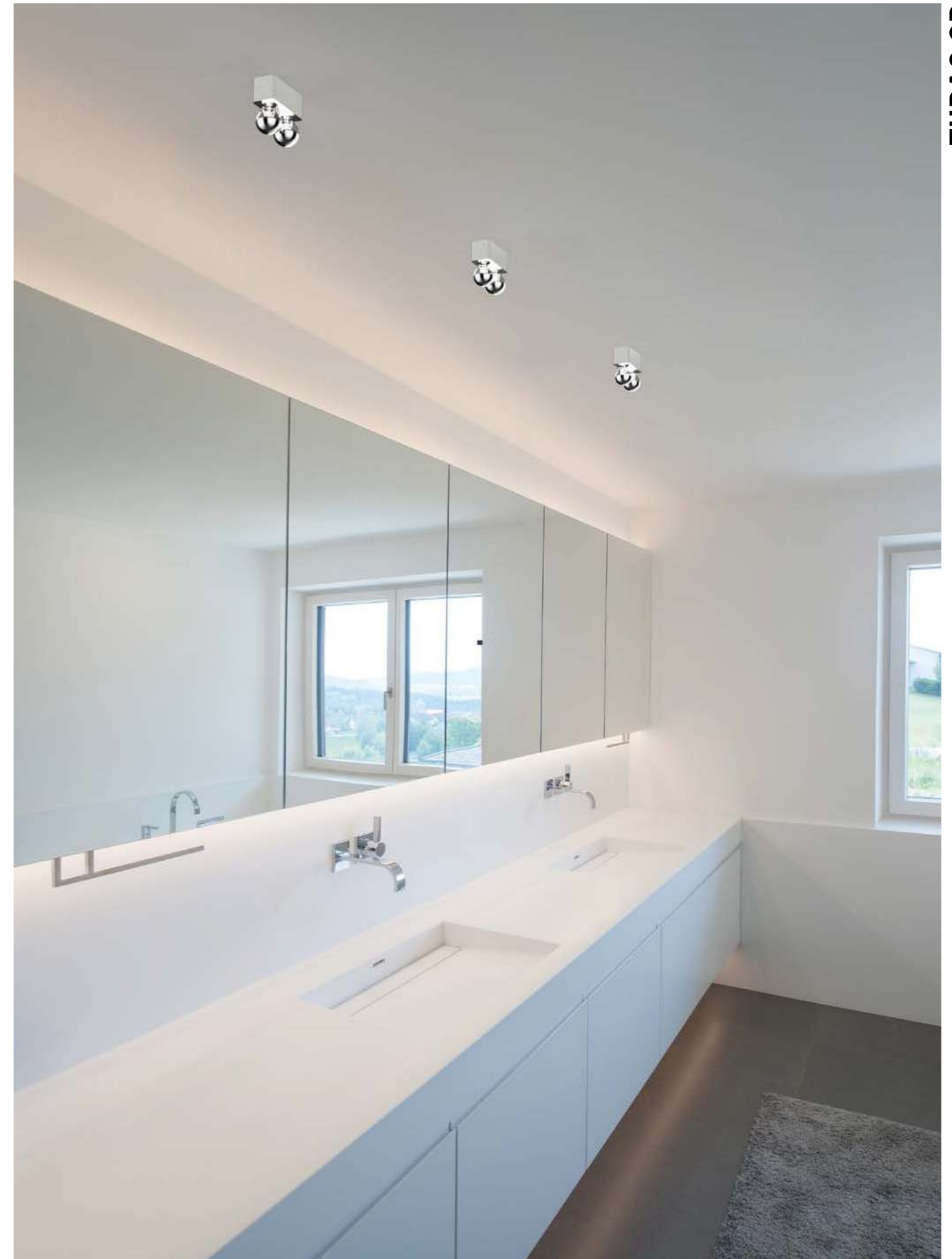
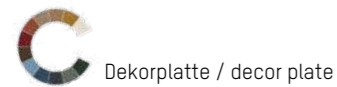
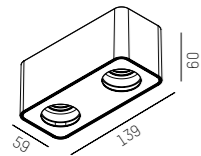



ANIO W

220-240V AC 50/60Hz CRI>90

LED Wandaufbauleuchte aus Aluminium - Oberfläche pulverbeschichtet - drehbar 90°, schwenkbar 350° - schaltbar

LED wall luminaire in aluminium - surface powder-coated - rotatable 90°, swivelling 350° - switchable

Lampada LED da parete in alluminio - superficie verniciata a polvere - ruotabile di 90°, girevole 350° - on/off

Applique murale LED en aluminium - surface thermolaquée - pivotant sur 90°, orientable sur 350° - on/off

LED 3W	LM
472-4003WXX0	170

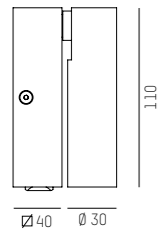

IP20

COMPLETE CODE	
W = LIGHT COLOUR	XX = COLOUR LUMINAIRE
W2 LED 2700K = 3 CRI>90	TE terra = 20
W3 LED 3000K = 9 CRI>90	W white = 50
	S black = 60

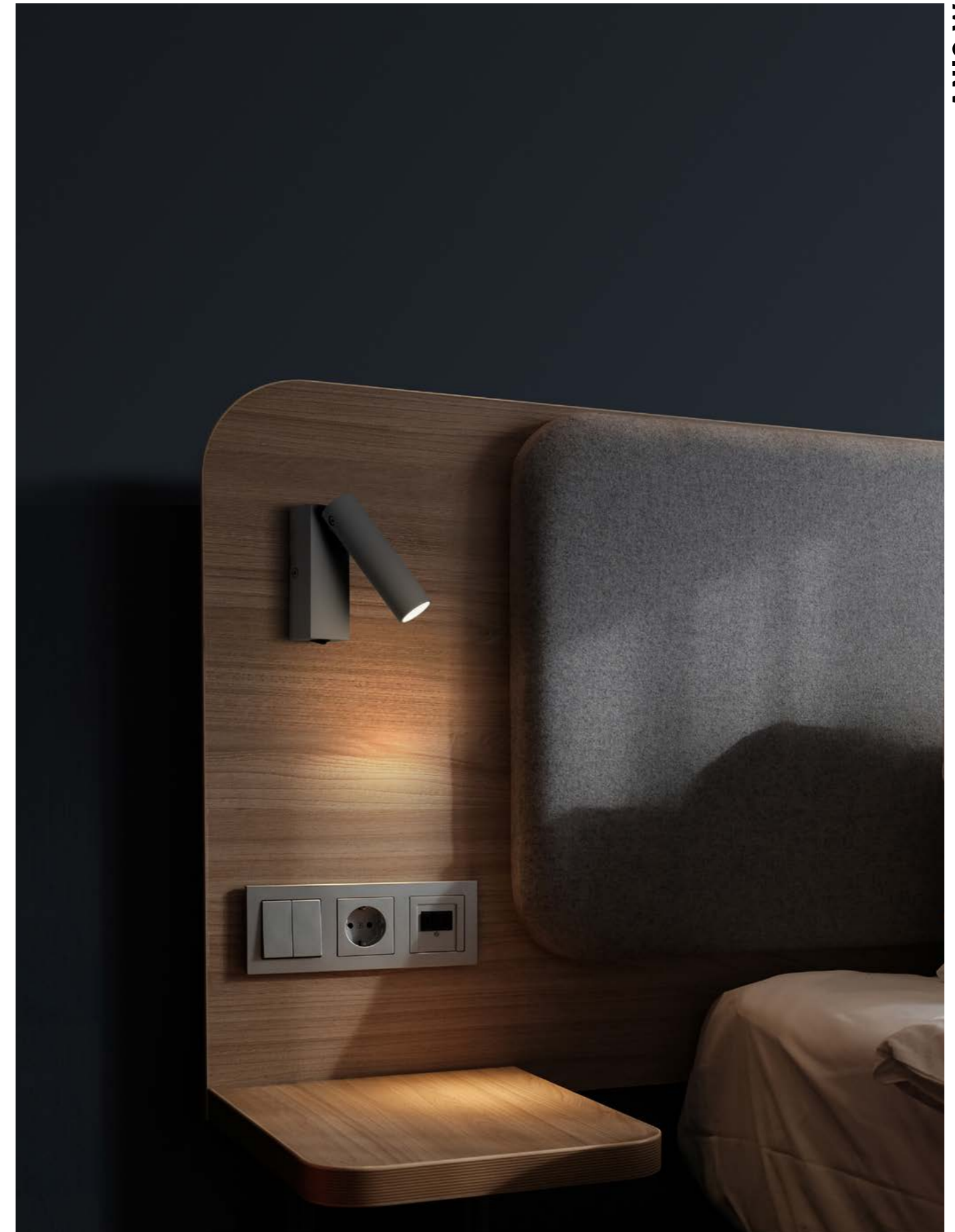

Technical data and energy efficiency





STYLISH RETRO LIGHT

Bei BEANY handelt es sich um einen vielseitigen Filzschirm in schlichtem Nostalgie-Design. Erhältlich ist diese Leuchtenfamilie als Hänge-, Steh- oder Tischleuchte. BEANY eignet sich als dekoratives Highlight in den Anwendungsbereichen Hotellerie, Gastronomie sowie Private Living.

With BEANY we have a wide-ranging felt cover in a simple nostalgic design. This luminaire family is available as a pendant, standing or table lamp. BEANY is suitable as a decorative highlight for use in the hotel industry or gastronomy as well as private living.

Design: Serge Cornelissen

BEANY



BEANY Design: Serge Cornelissen
220-240V AC 50/60Hz A60 / E27 / Retrofit max. 7W

Leuchtenserie mit E27 Fassung aus schwarzem Metall · Oberfläche pulverbeschichtet mit Schirm aus Filz · symmetrische und asymmetrische Befestigung · schaltbar + dimmbar (T & F)

Lamp series with E27 socket in black metal · powder-coated surface with felt shade · symmetric and asymmetric fixing · switchable + dimmable (T & F)

Serie di lampade con portalampada E27 in metallo nero · superficie verniciata a polvere con paralume in feltro · fissaggio simmetrico ed asimmetrico · on/off + dimmerabile (T & F)

Série de luminaires avec douille E27 en métal noir · surface thermolaquée avec abat-jour en feutre · fixation symétrique et asymétrique · on/off + dimmable (T & F)



BEANY PD	FARBE	SCHIRM
BEANY PD	COLOUR	SHADE
122-0110221000600	black	anthrazith

BEANY T	FARBE	SCHIRM
BEANY T	COLOUR	SHADE
122-020212000060a	black	anthrazith
Kabelschalter dimm. / Cable switch dimm.		

BEANY F	FARBE	SCHIRM
BEANY F	COLOUR	SHADE
122-030112000060a	black	anthrazith
Kabelschalter dimm. / Cable switch dimm.		

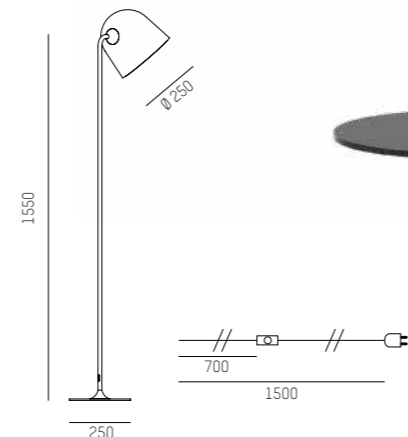
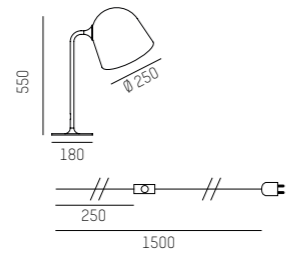
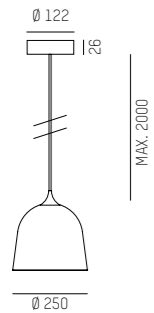

IP 20 Leuchtmittel: Siehe Seite: 550 / lamps: look at page 550
(Mindestens 7W LED Retrofit verwenden/ Use at least 7W LED retrofit)



Technical data and energy efficiency



BEANY PD



BEANY T



BEANY F

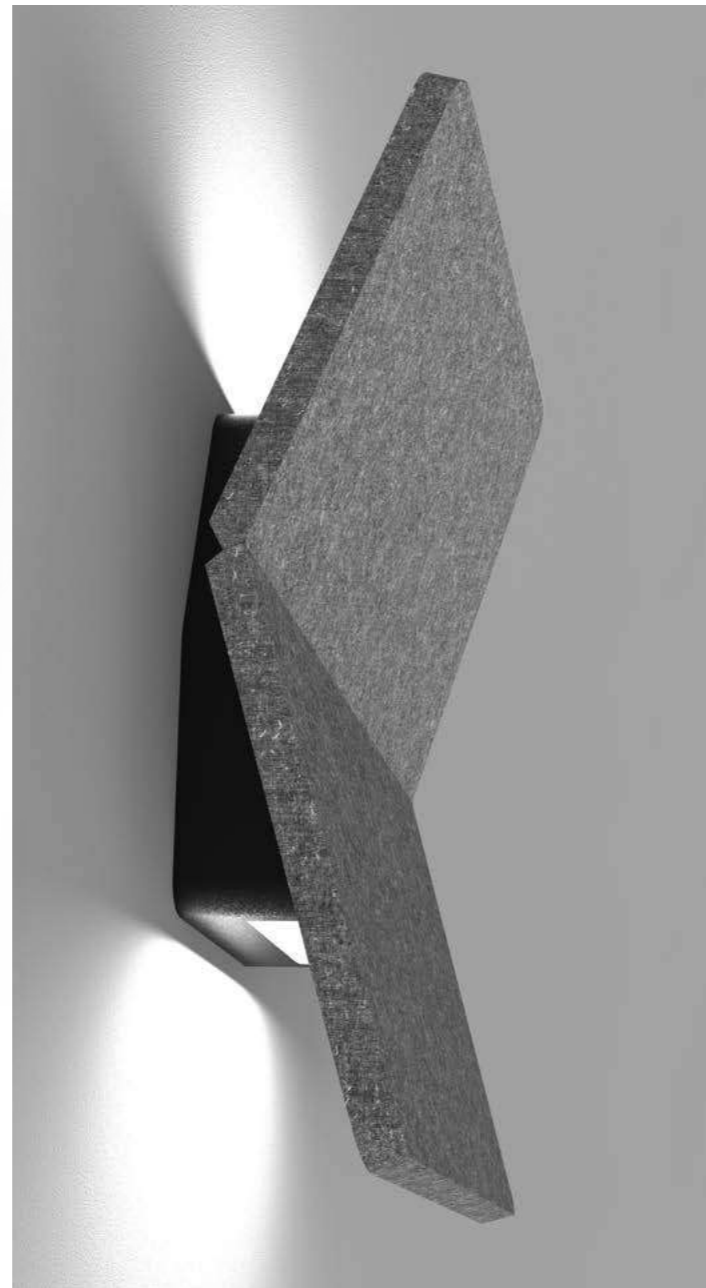

HENDRIK W Design: INHOUSE
220-240V AC 50/60Hz LED 2700 / 3000K CRI>90

LED Wandleuchte aus Aluminium · Oberfläche pulverbeschichtet · Dekorplatte aus Filz · in 4 verschiedenen Farben erhältlich · schaltbar

LED wall luminaire in aluminium · surface powder-coated · felt decorative plate · available in 4 colours · switchable

Lampada LED da parete in alluminio · superficie verniciata a polvere · pannello decorativo in feltro · disponibile in 4 colori · on/off

Applique murale LED en aluminium · surface thermolaquée · panneau décoratif en feutre · disponible en 4 couleurs · on/off

HENDRIK M W

SYS 13W	FARBE	LM
SYS 13W	COLOUR	LM
590-011120100s600	blue	350
590-011120200s600	anthrazith	350
590-011120300s600	light grey	350
590-011120400s600	seagrass	350

Lichtfarbe 2700 oder 3000K manuell einstellbar
Light colour 2700 or 3000K adjustable
nicht dimmbar / not dimmable

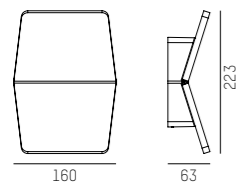

IP20 Ⓢ CE

HENDRIK L W

SYS 13W	FARBE	LM
SYS 13W	COLOUR	LM
590-011130100s600	blue	240
590-011130200s600	anthrazith	240
590-011130300s600	light grey	240
590-011130400s600	seagrass	240

Lichtfarbe 2700 oder 3000K manuell einstellbar
Light colour 2700 or 3000K adjustable
nicht dimmbar / not dimmable

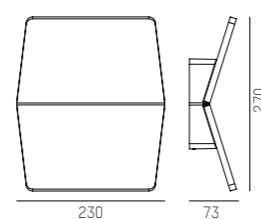

510

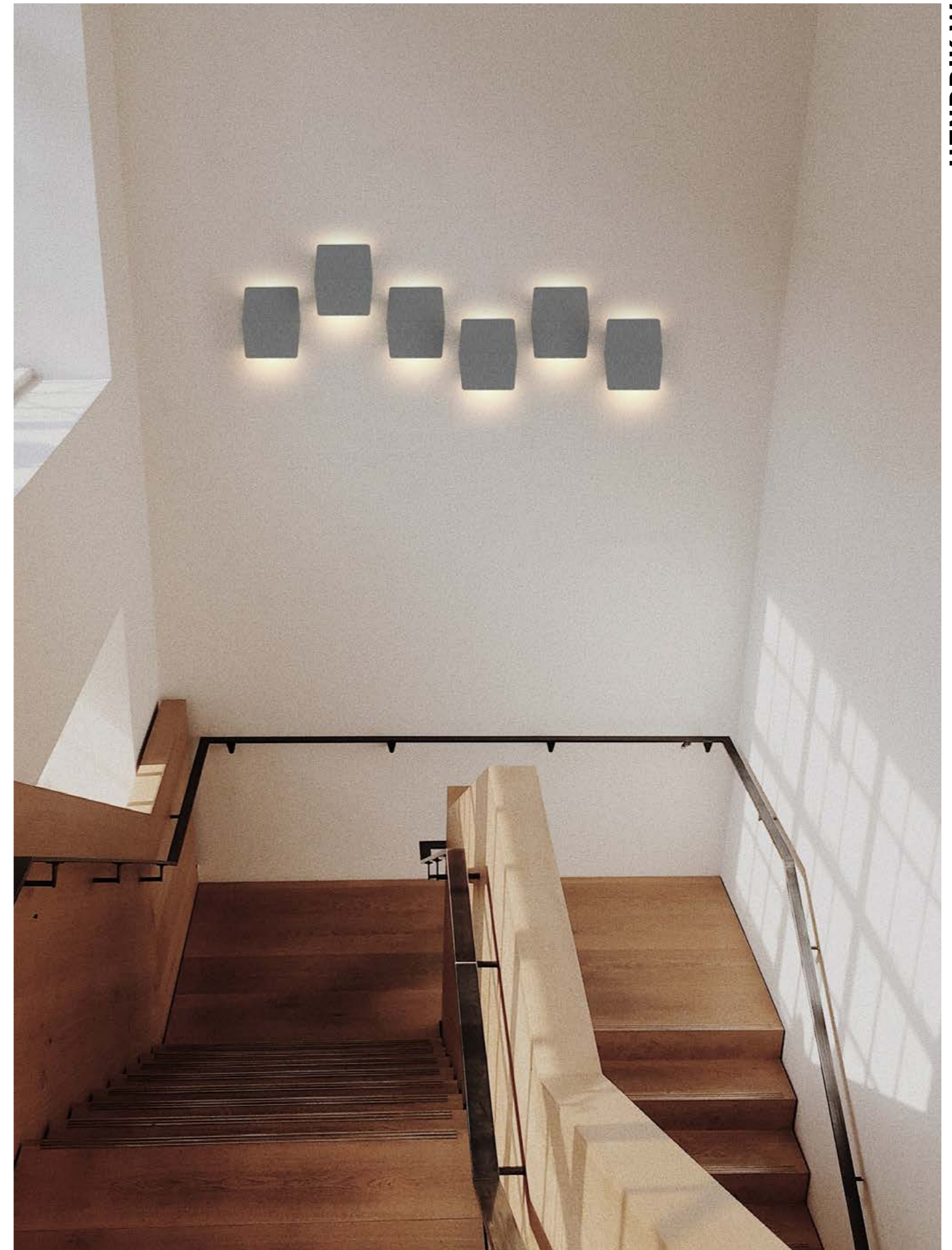

HENDRIK W

Technical data and energy efficiency



HENDRIK M W



HENDRIK L W

511

BACK TO CONTENT



MEYJO Design: INHOUSE
220-240V AC 50/60Hz CRI>90 / 3000K

LED Tisch- oder Stehleuchte aus Aluminium · Oberfläche pulverbeschichtet · in 3 Farben erhältlich · Sensordimmer

LED table or floor lamp in aluminium · surface powder-coated · available in 3 colours · sensor dimmer

Piantana LED in alluminio · superficie verniciata a polvere · disponibile in 3 colori · sensore dimmer

Lampadaire LED en aluminium · surface thermolaquée · disponible en 3 couleurs · variateur à capteur

MEYJO T

SYS 9W	FARBE	LM
SYS 9W	COLOUR	LM
472-5001920s	terra	350
472-5001950s	white	350
472-5001960s	black	350

Sensordimmer / Lichtaustritt: 28°
sensor dimmable / beam angle: 28°

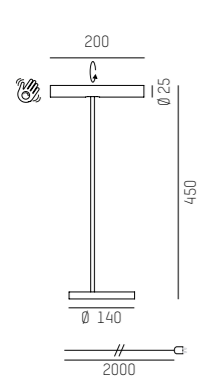

MEYJO F

SYS 9W	FARBE	LM
SYS 9W	COLOUR	LM
472-6001920s	terra	350
472-6001950s	white	350
472-6001960s	black	350

Sensordimmer / Lichtaustritt: 28°
sensor dimmable / beam angle: 28°

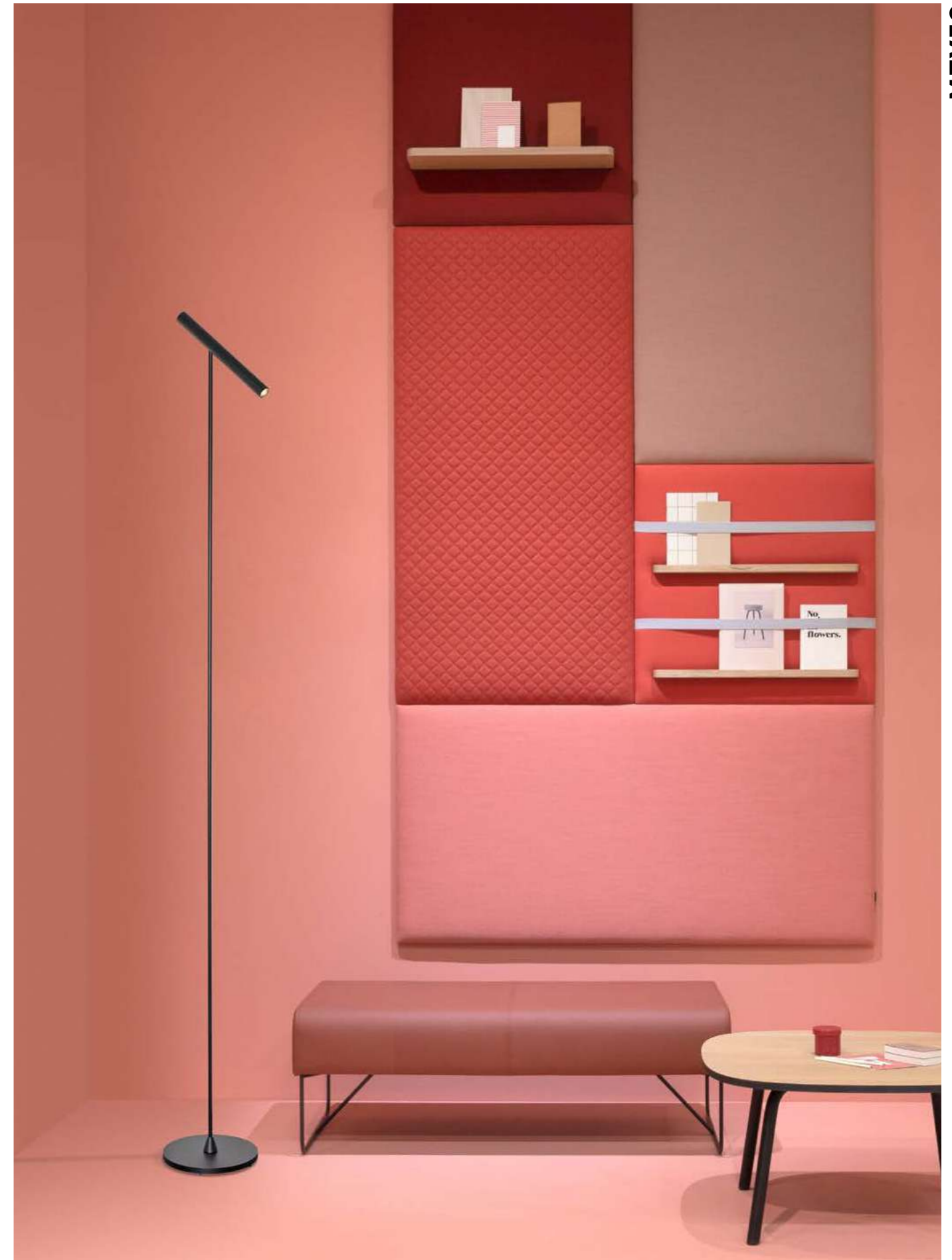
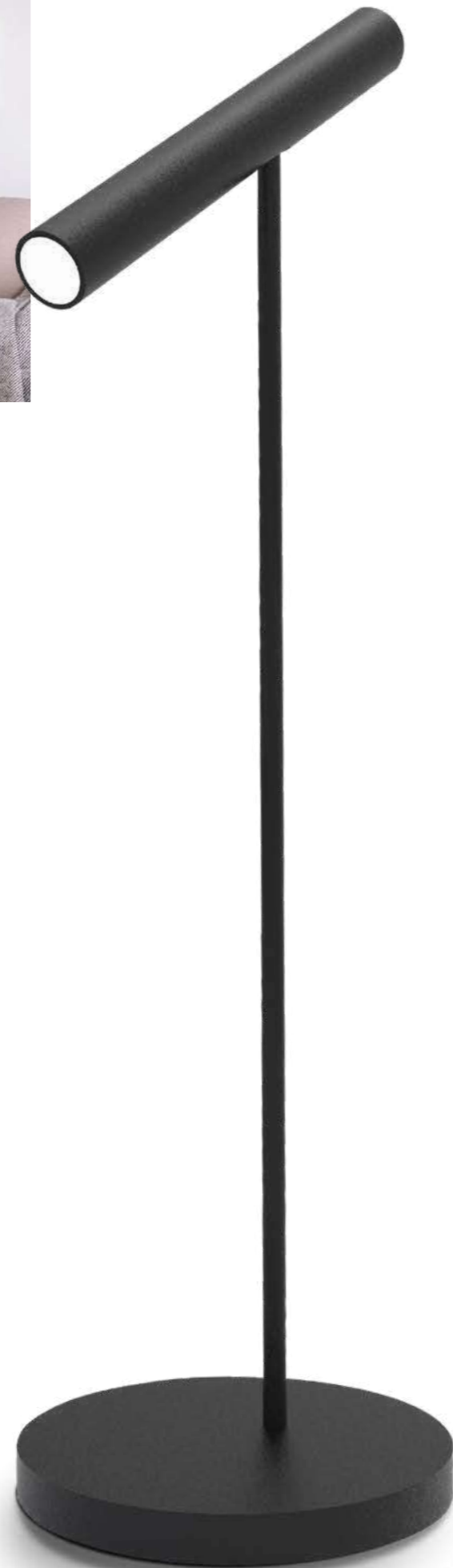
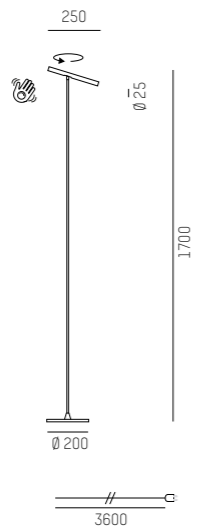

Technical data and energy efficiency



MEYJO T



MEYJO F

TREPOLE F

220-240V AC 50/60Hz 3000K / CRI>90

LED Stehleuchte aus Aluminium mit flexiblen Lichtstäben · Oberfläche pulverbeschichtet · in 2 Farben erhältlich · schattbar

LED floor lamp in aluminium with flexible bars · powder-coated surface · available in 2 colours · switchable

Piantana LED in alluminio con barre luminose spostabili · superficie verniciata a polvere · disponibile in 2 colori · on/off

Lampadaire LED en aluminium avec baguettes lumineuses flexibles · surface thermolaquée · disponible en 2 couleurs · on/off

SYS 64W	FARBE	LM
SYS 64W	COLOUR	LM
472-60023600	black	2750
472-60023300	gold	2750

Kabelschalter / cable switchable

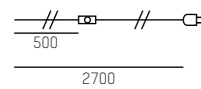
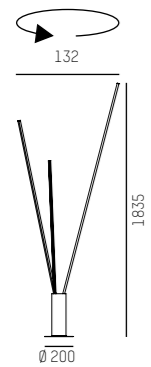

IP20 CE

514

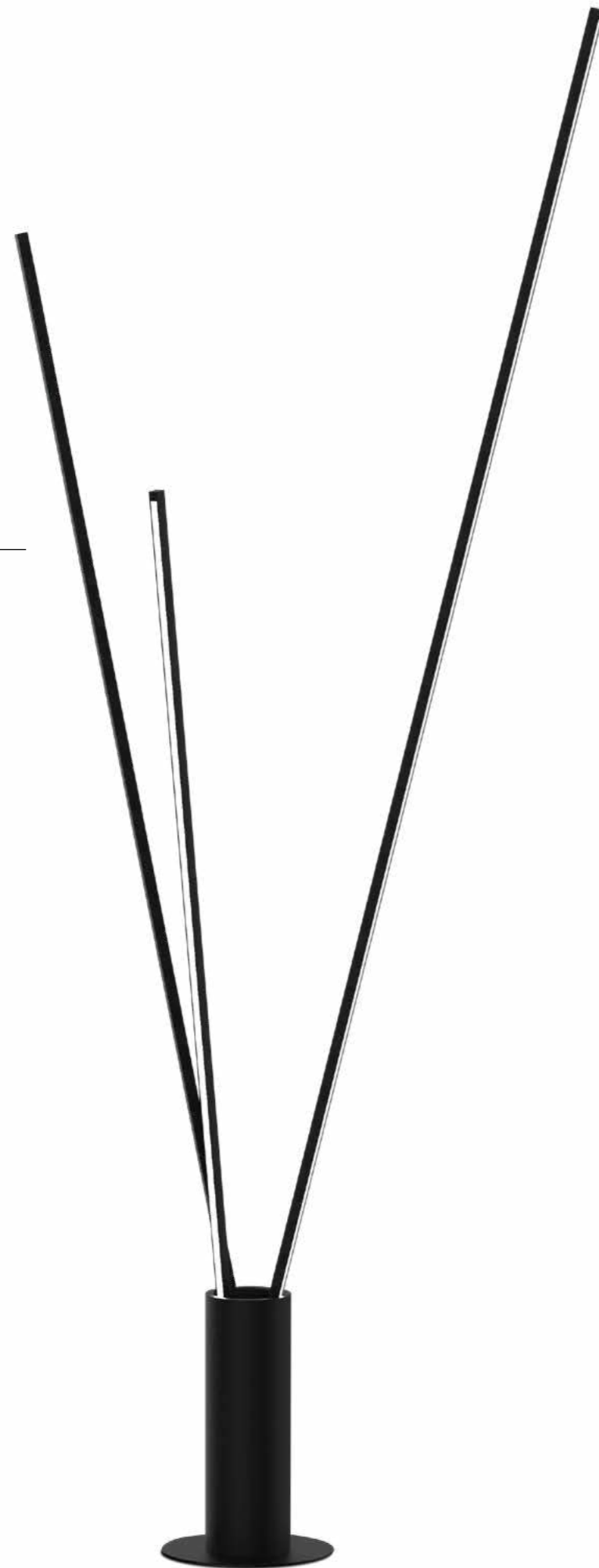

Technical data and energy efficiency



TREPOLE F

BACK TO CONTENT

TREPOLE F

515



SCAVE T Design: Serge Cornelissen
 220-240V AC 50/60Hz CRI>90 / 3000K

Tischleuchte aus Aluminium · Oberfläche 2 färbig pulverbeschichtet · dimmbar mittels Sensor Dim

Table lamp made of aluminium · 2-colour powder-coated surface · dimmable via Sensor Dim

Lampada da tavolo in alluminio · superficie verniciata a polveri in due colori · dimmerabile attraverso Sensor Dim

Lampe de table en aluminium · surface revêtue de poudre, en deux couleurs · Gradable via Sensor Dim

SYS 12W	FARBE	LM
SYS 12W	COLOUR	LM
738-5002962s	black / terra	400
738-5002965s	black / white	400

Sensor dimmbar / sensor dimmable

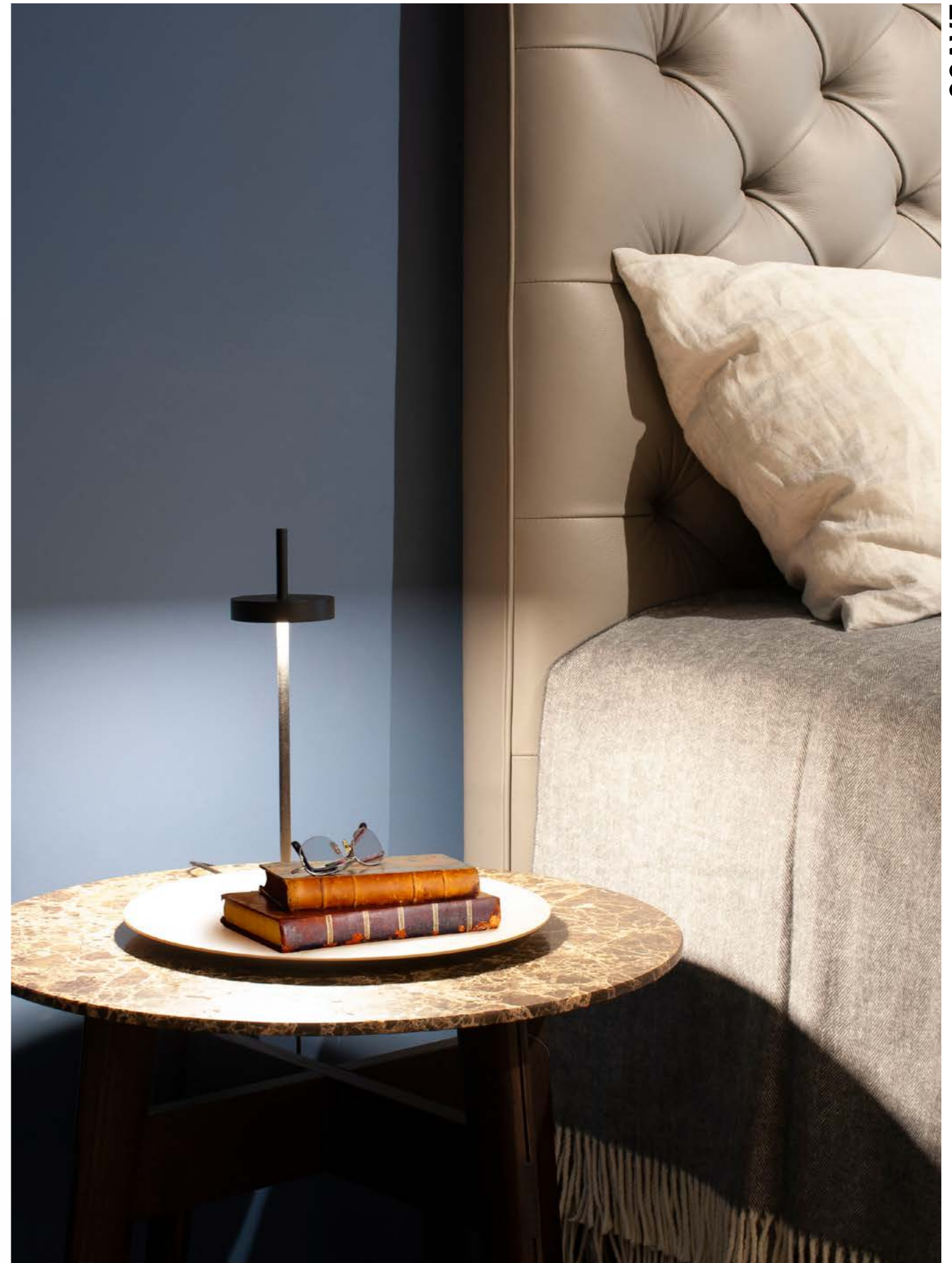
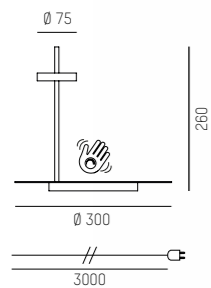

Technical data and energy efficiency





TE0 T

220-240V AC 50/60Hz CRI>80 / 3000K

LED Tischleuchte · Oberfläche pulverbeschichtet · Schirm aus transparentem LGP Board · Dimmbarkeit mittels Touch Dim

LED table luminaire · surface powder-coated · shade made of transparent LGP board · dimmable via Touch Dim

Lampada LED da tavolo · superficie verniciata a polvere · paralume in plexiglass LGP trasparente · dimmerabile tramite Touch Dim

Lampe de table LED · surface thermolaquée · abat-jour en matériau LGP transparent · dimmable Touch Dim

SYS 6W	FARBE	LM
SYS 6W	COLOUR	LM
101-500096ok	black	400

Kabeldimmer / cable dimmable

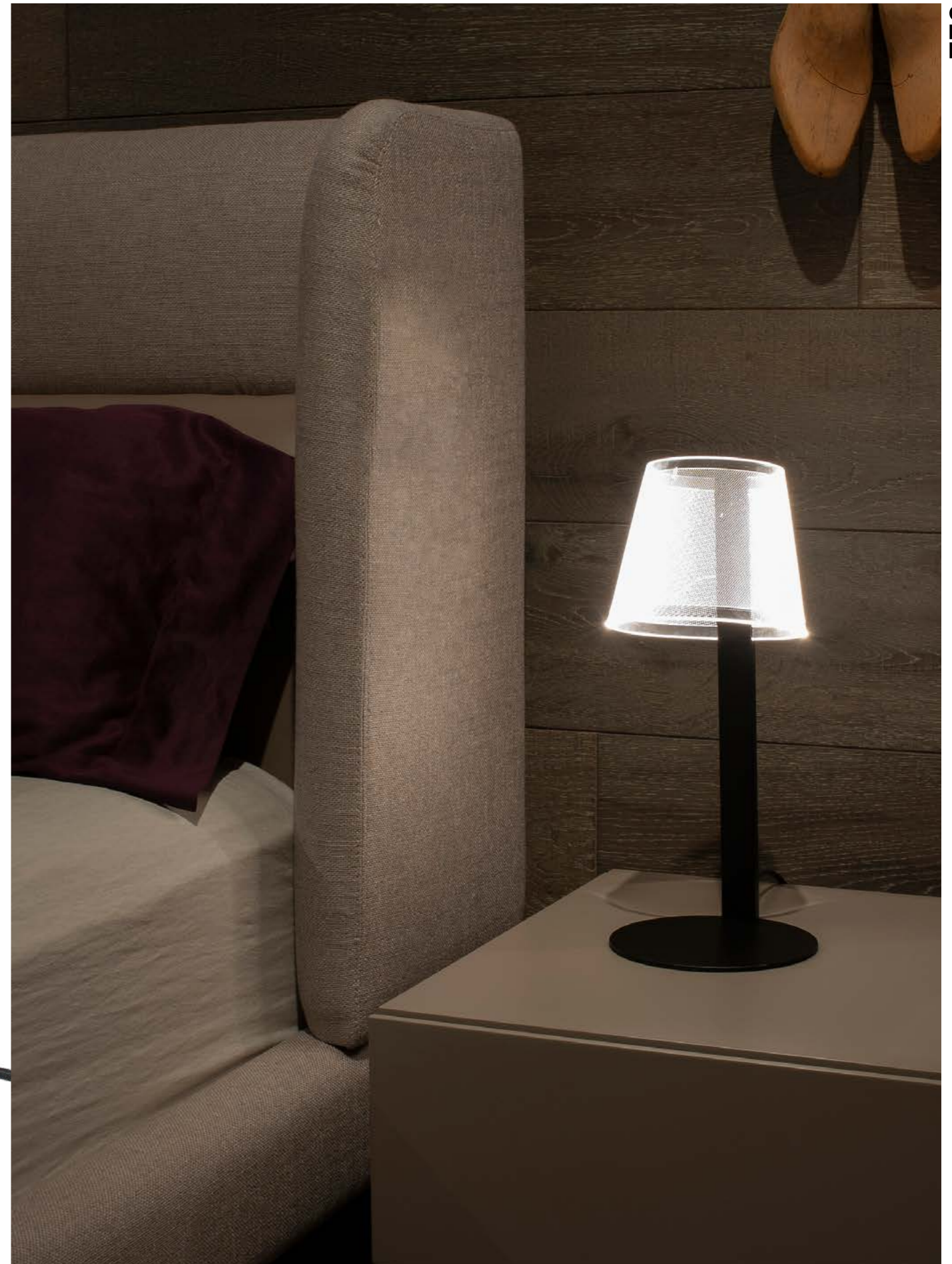
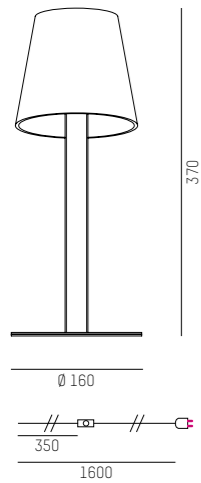

TE0

Technical data and energy efficiency



TE0 T



OUTDOOR



HEAVENLY LIGHT MOOD

Die Akkuleuchte EEDEN besticht durch ihr reduziertes Design in Kombination mit innovativer Technik. Ein flexibler Leuchtenkopf lässt sich mit spannenden Accessoires auf unterschiedlichste Arten platzieren oder befestigen. Egal ob Standfuß, Tischklemme, Erdspieß oder Seil zum Abhängen auf Ästen, Balkon und Sonnenschirmen, der Projektgestaltung sind keine Grenzen gesetzt. EEDEN kann einfach mittels USB-C Kabel geladen werden

The reduced design combined with the innovative technology of the EEDEN battery-powered luminaire is impressive. A flexible luminaire head can be placed or fixed in a variation of ways using fascinating accessories. Whether pedestal, table clamp, ground stake or rope to hang it from branches, a balcony or sun umbrella, there's no limit to your creativity. EEDEN can easily be charged with a USB-C cable

Design: Serge Cornelissen

EEDEN



Versions



Colours

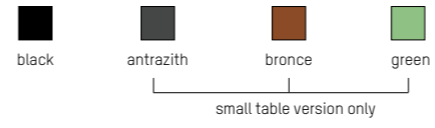

LED Colour



Specials



Tunable white
small table version



Design: Serge Cornelissen



EEDEN M PD

Design: Serge Cornelissen

3,7 VDC 2700K / 3000K / CRI>80

Hängeleuchte mit flexiblem satiniertem Leuchtenkopf · Seil als Abhängung für individuelle Montage in 2 Farben erhältlich · 11h Akkulaufzeit bei 100% Leuchtkraft · 3 Stufen dimmbar · zu 3 Stück stapelbar · IP65

Suspension with flexible satined lamp head · suspension rope for individual mounting available in 2 colours · 11h battery life at 100% luminosity dimmable 3 levels · stackable to 3 pieces · IP65

Sospensione con testa flessibile satinata · Cavo di sospensione per montaggio personalizzabile disponibile in 2 colori · durata della batteria 11 ore al 100% di luminosità · dimmerabile in tre step · impilabile fino a 3 pezzi · IP65

Suspension avec tête de lampe flexible satinée · câble de suspension pour montage individuel disponible en 2 couleurs · 11h d'autonomie à 100% d'intensité lumineuse · dimmable 3 niveaux · empilable par 3 · IP65

EEDEN M PD

3,7 V DC / USB ACCU	LEUCHTE	SEIL	LICHTFARBE	LM
3,7 V DC / USB ACCU	LUMINAIRE	ROPE	LIGHT COLOUR	LM
135-9001366t	black	black	2700K	140
135-900136tt	black	red	2700K	140
135-9001966t	black	black	3000K	140
135-900196tt	black	red	3000K	140

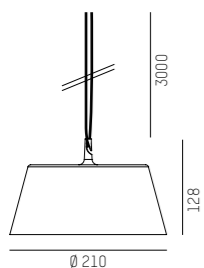

Technical data and energy efficiency

Private residence
Austria
Photo: Joachim Rauch



EEDEN M F Design: Serge Cornelissen
3,7 VDC 2700K / 3000K / CRI>80

Stehleuchte mit flexiblem satiniertem Leuchtenkopf · Standfuß oder Erdspeiß aus Metall · Oberfläche pulverbeschichtet · 11h Akkulaufzeit bei 100% Leuchtkraft · 3 Stufen dimmbar · zu 3 Stück stapelbar · IP65

Floor lamp with flexible satined lamp head · metal stand or ground pike · powder-coated surface · 11h battery life at 100% luminosity · dimmable 3 levels · stackable to 3 pieces · IP65

Piantana con testa flessibile satinata · struttura in metallo · superficie verniciata a polvere · durata della batteria 11 ore al 100% di luminosità dimmerabile in tre step · impilabile fino a 3 pezzi · IP65

Lampadaire avec tête de lampe flexible satinée · pied en métal · surface thermolaquée · 11h d'autonomie à 100% d'intensité lumineuse · dimmable 3 niveaux · empilable par 3 · IP65

EEDEN M F 1

3,7 V DC / USB ACCU	LEUCHE	LICHTFARBE	LM
3,7 V DC / USB ACCU	LUMINAIRE	LIGHT COLOUR	LM
135-9004366t	black	2700K	140
135-9004966t	black	3000K	140

Version mit Standfuß / Version with stand

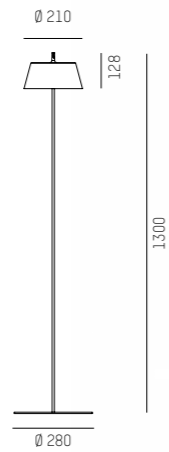

EEDEN M F 2

3,7 V DC / USB ACCU	LEUCHE	LICHTFARBE	LM
3,7 V DC / USB ACCU	LUMINAIRE	LIGHT COLOUR	LM
135-9005366t	black	2700K	140
135-9005966t	black	3000K	140

Version mit Erdspeiß / Version with ground pike

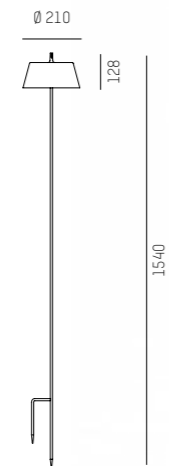

Private residence
Austria
Photo: Joachim Rauch

Technical data and energy efficiency



EEDEN M F 1



EEDEN M F 2



EEDEN T Design: Serge Cornelissen
3,7 VDC 2700K / 3000K / CRI>80

Tischleuchte mit flexiblem satiniertem Leuchtenkopf · Struktur aus Metall · Oberfläche pulverbeschichtet · 11h Akkulaufzeit bei 100% Leuchtkraft · 3 Stufen dimmbar · zu 3 Stück stapelbar · IP65

Table luminaire with flexible satined lamp head · metal structure · powder-coated surface · 11h battery life at 100% luminosity · dimmable 3 levels · stackable to 3 pieces · IP65

Lampada da tavolo con testa flessibile satinata · struttura in metallo · superficie verniciata a polvere · durata della batteria 11 ore al 100% di luminosità · dimmerabile in tre step · impilabile fino a 3 pezzi · IP65

Lampe de table avec tête de lampe flexible satinée · socle ou pince de table en métal · surface thermolaquée · 11h d'autonomie à 100% d'intensité lumineuse · dimmable 3 niveaux · empilable par 3 · IP65

EEDEN M T

3,7 V DC / USB ACCU	LEUCHE	LICHTFARBE	LM
3,7 V DC / USB ACCU	LUMINAIRE	LIGHT COLOUR	LM
135-9002366t	black	2700K	140
135-9002966t	black	3000K	140

Version mit Standfuss / Version with stand

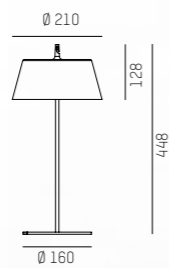

EEDEN M C T

3,7 V DC / USB ACCU	LEUCHE	LICHTFARBE	LM
3,7 V DC / USB ACCU	LUMINAIRE	LIGHT COLOUR	LM
135-9003366t	black	2700K	140
135-9003966t	black	3000K	140

Version mit Tischklammer / Version with table clamb

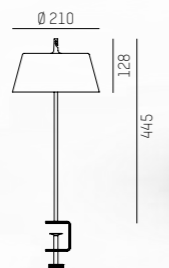

Private residence
Austria
Photo: Joachim Rauch



EEDEN M T



EEDEN M C T



EEDEN S T Design: Serge Cornelissen
3,7 VDC 2700K - 3000K / CRI>80

Tischleuchte mit satiniertem Leuchtenkopf · Oberfläche pulverbeschichtet · in 4 Farben erhältlich · 8h Akkulaufzeit bei 100% Leuchtkraft · stufenlos dimmbar · Tunable white · IP65

Table luminaire with satined lamp head · powder-coated surface available in 4 colours · 8h battery life at 100% luminosity · continuously dimmable · Tunable white · IP65

Lampada da tavolo con testa satinata · superficie verniciata a polvere disponibile in 4 colori · durata della batteria 11 ore al 100% di luminosità dimmerazione continuativa · Tunable white · IP65

Lampe de table avec tête de lampe satinée · surface thermolaquée disponible en 4 couleurs · 8h d'autonomie à 100% d'intensité lumineuse dimmable en continu · Tunable white · IP65

EEDEN S T

3,7 V DC / USB ACCU	LEUCHTE	LICHTFARBE	LM
3,7 V DC / USB ACCU	LUMINAIRE	LIGHT COLOUR	LM
135-9006s65t	black	2700K-3000K	120
135-9006su5t	rust brown	2700K-3000K	120
135-9006s95t	anthracite	2700K-3000K	120
135-9006ss5t	green	2700K-3000K	120

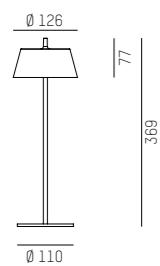

Technical data and energy efficiency



EEDEN S T



BOHO

220-240V AC 50/60Hz CRI>80

Außenleuchterserie in trendigem Look aus Aluminium · pulverbeschichtete Oberfläche · E27 Fassung oder AC LED · IP65

Outdoor luminaire series in trendy look in aluminium · surface powder-coated · E27 socket or AC LED · IP65

Serie di lampade moderne da esterno in alluminio · superficie verniciata a polvere · portalampada E27 o AC LED · IP65

Série de luminaires extérieurs modernes en aluminium · surface thermo-laquée · douille E27 ou AC LED · IP65

BOHO F

E27 Retrofit max. 9W	FARBE
E27 Retrofit max. 9W	COLOUR
401-90008600	black

BOHO W

SYS 7W AC	FARBE	LM
SYS 7W AC	COLOUR	LM
401-90019600	black	500
3000K, CRI>80		

BOHO PD

SYS 7W AC	FARBE	LM
SYS 7W AC	COLOUR	LM
401-90029600	black	500
3000K, CRI>80		

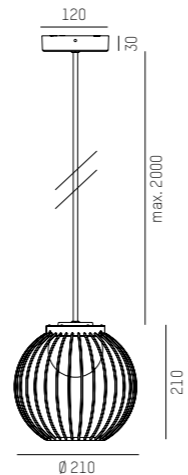
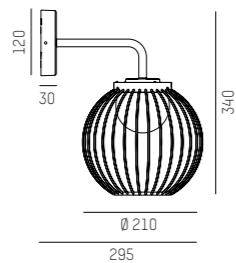
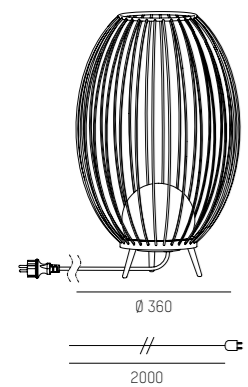

BOHO

Technical data and energy efficiency



BOHO F



BOHO W



BOHO PD



PEGATO W

220-240V AC 50/60Hz CRI>90 / 3000K

LED Wandaufbauleuchte aus Aluminium · Oberfläche pulverbeschichtet · in 3 Farben erhältlich · schaltbar · IP54

LED wall luminaire in aluminium · surface powder-coated surface · available in 3 colours · switchable · IP54

Lampada LED da parete in alluminio · superficie verniciata a polvere · disponibile in 3 colori · on/off · IP54

Applique murale LED en aluminium · surface thermolaquée · disponible en 3 couleurs · on/off · IP54

SYS 6W	FARBE	LM
SYS 6W	COLOUR	LM
472-9001920	terra	300
472-9001950	white	300
472-9001960	black	350

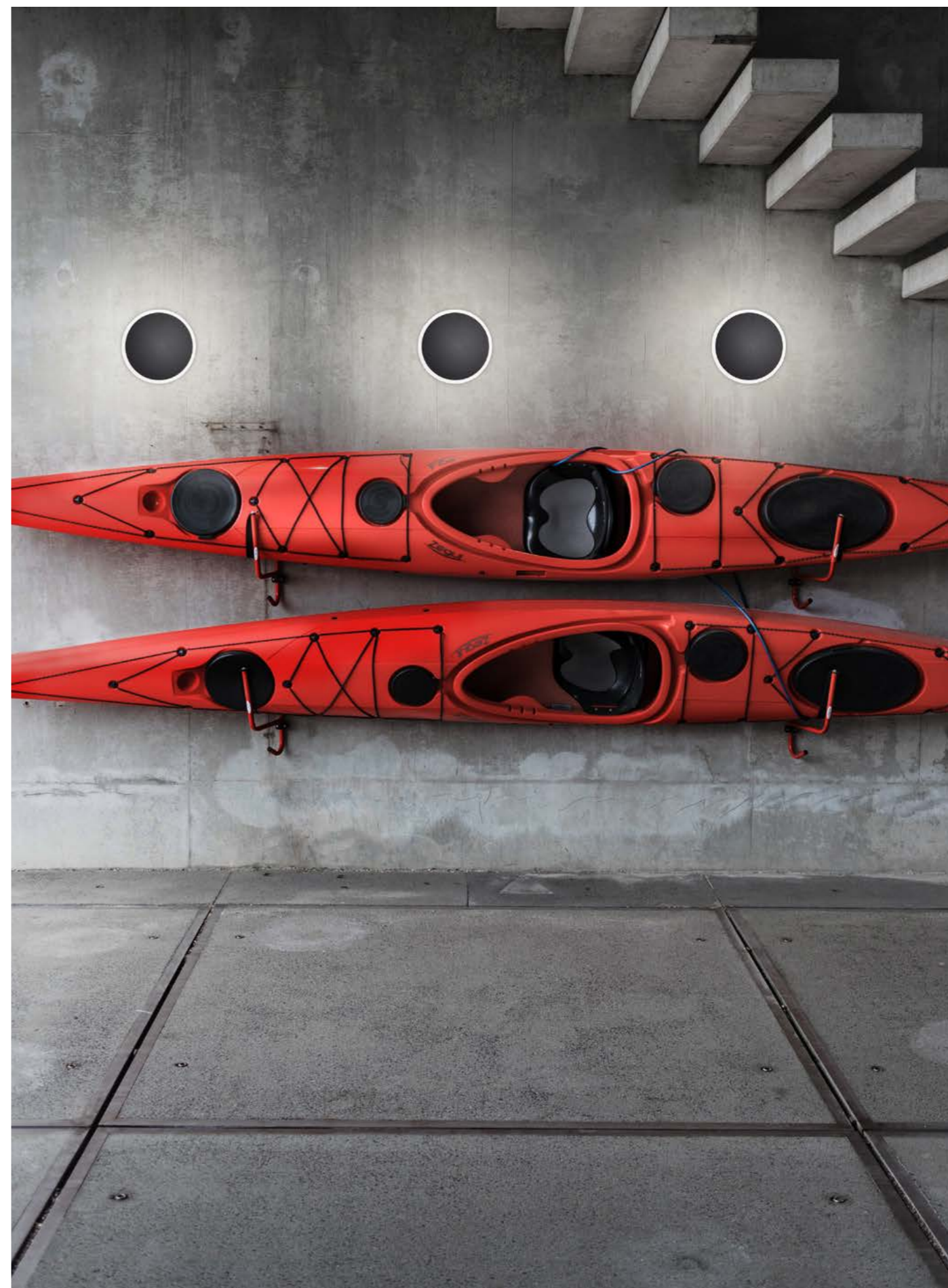
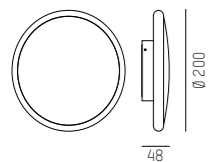

BLUETOOTH GATEWAY BASIC

Zusätzlich zur App erforderlich bei zeitgesteuerten Abläufen
In addition to the app required for timed operations

701-0001



BLUETOOTH GATEWAY PREMIUM

Zusätzlich zur App erforderlich bei zeitgesteuerten Abläufen. Inkl. Alarm- & Heatmapfunktion
In addition to the app required for timed operations. Incl. alarm- & heatmapfunction

701-0002



RECESSED MOVEMENT DEDECTOR

Inkl. 1m Kabel & Einbauhülse
Incl. 1m cable & recessing sleeve

701-2006

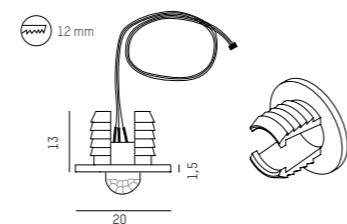

DRIVER SMART BLUETOOTH

Zur Integration als dimmbare Leuchte in die MOLTO LUCE Smart App; in Kombination mit dem separat erhältlichen Sensor auch für alle Premium Anwendungen nutzbar
To integrate as dimmable luminaries in the MOLTO LUCE Smart App; in combination with the separate available sensor also useable for all premium applications

701-1001

BLUETOOTH Dimm.

350 - 1050mA / 18,5 - 50W

L 129 x B 76 x H 30mm

84mm



DRIVER SMART BLUETOOTH

Zur Integration als dimmbare Leuchte in die MOLTO LUCE Smart App
To integrate as dimmable luminaries in the MOLTO LUCE Smart App

701-1007

BLUETOOTH Dimm.

300 - 1050mA / 16 - 38W

L 146 x B 44 x H 30mm

54mm



INTERFACE SMART BLUETOOTH TO DALI

Zur Integration von max. 40 Dali dimmbaren Leuchte in die MOLTO LUCE Smart App; Broadcast Mode
To integrate max. 40 dali dimmable luminaries in the MOLTO LUCE Smart App; Broadcast Mode

701-1003

BLUETOOTH Dimm.

Smart BLUETOOTH to DALI

L 85 x B 30 x H 22mm

40mm



PUSH BUTTON INTERFACE

Zur Integration von handelsüblichen Tastern in die MOLTO LUCE Smart App
To integrate conventional Push-Button in the MOLTO LUCE Smart App

701-1005

BLUETOOTH Dimm.

3 Kanal UP-Dosenmodul / 3 Channel built in Modul

L 43 x B 43 x H 18mm



Molto Luce Stand
Düsseldorf, Germany

CRI>80



Magic Colour



Magic Colour

- Spezielle Lichtfarbe für Obst & Gemüse
Überzeichnete Farben, sehr hoher R9 Rot-Anteil
- Special light colour for fruits & vegetables
Exaggerated colours, very high R9 red value

Spectral Power Distribution Comparison

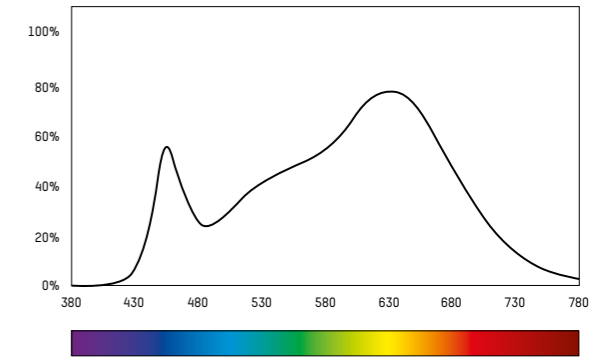

CRI>80



Bread



Bread

- Spezielle Lichtfarbe in 2400K für Back- & Teigwaren
Reduzierter Blau-Anteil im Farbspektrum
- Special light colour in 2400K for bread & pastries
Reduced blue parts in the colour spectrum

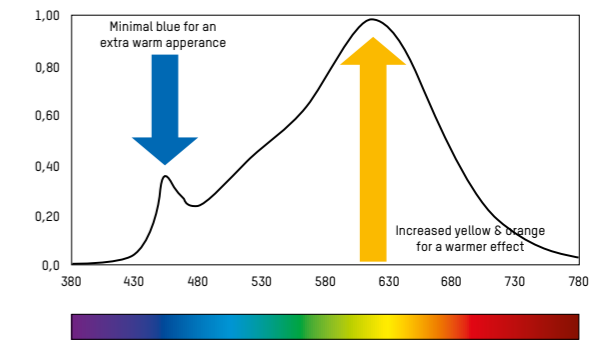

CRI>80



Meat



Marble meat

- Spezielle Lichtfarbe für Fleisch- & Wurstwaren
Verbesserter Rot-Anteil & natürliches Weiß
- Special light colour for meat
Higher red part & natural white

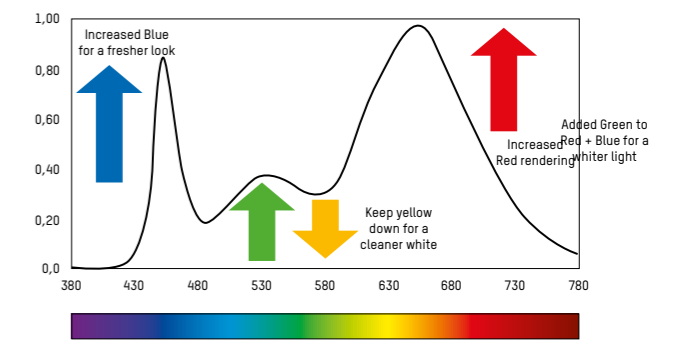

Red meat

- Spezielle Lichtfarbe für Fleischwaren
Verbesserter Rot-Anteil
- Special light colour for meat
Higher red part

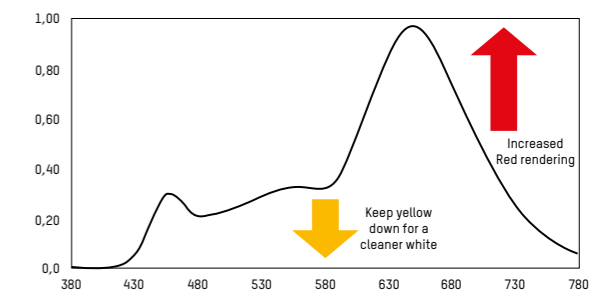

CRI>80



Fish



Fish

- Spezielle Lichtfarbe für Fisch
Verbesserter Blau-Anteil & natürliches Weiß
- Special light colour for fish
Higher blue part & natural white

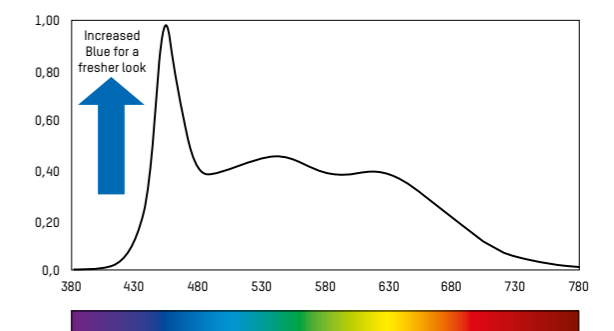

CRI>80



Molto Luce Premium CRI>90



Premium CRI>90

Bester Kompromiss aus Effizienz und Lichtqualität
Best mix of efficiency and lighting quality

Unsere Standard LED, sehr gute Weißwiedergabe, erhöhter R9 Wert, natürliche Wiedergabe von Farben

Our Standard LED, brilliant white effect, increased R9 Index, natural colour fidelity

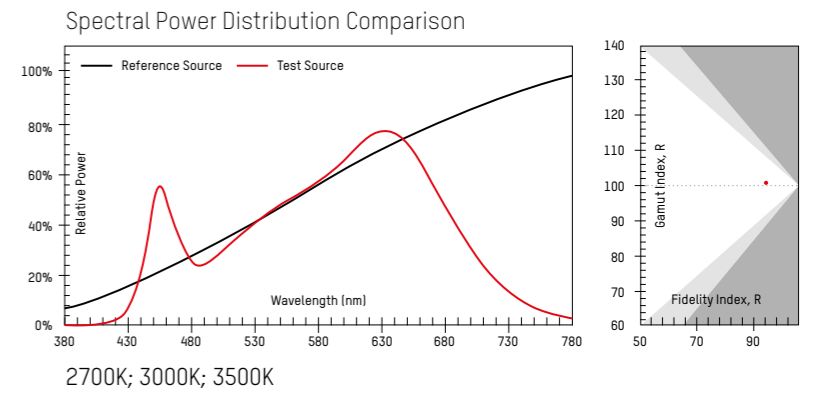

CRI>80



Magic Colour CRI>90



Magic Colour CRI>90

Bietet die beste Lichtqualität
Delivers the best quality of light

Überzeichnet Farben, sehr hoher R9 Wert
Bei Farben: Beste LED!

More saturated colours, high R9 Index
Highlighting rich colours

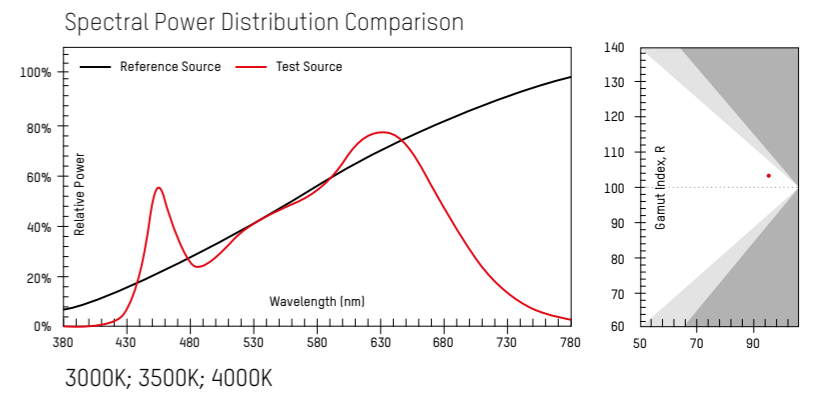

CRI>80



Magic White CRI>90



Magic White CRI>90

Das beste und reinste Weiß, wie bei Tageslicht
The best and richest whites, just like in daylight

Speziell für Weiße Objekte, das spezielle Spektrum aktiviert die fluoreszierenden Weißmacher, so entsteht ein billianter weiß Effekt

Provides the brilliant white effect that other solutions don't have. Extra Peak in violet area improves whites

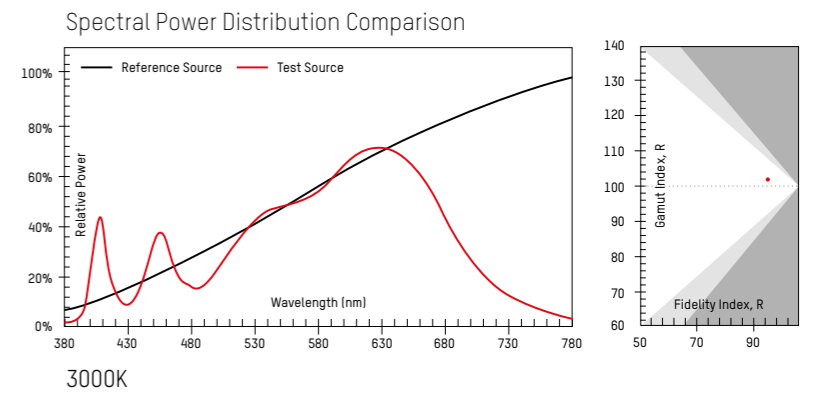

BLUETOOTH



Bluetooth dimmbar an der Standard Schiene
Bluetooth dimmable at the standard track

Bluetooth Mesh Netzwerk direkt oder mit Gateway steuerbar
Bluetooth mesh network directly or gateway controllable

FUNKTIONSUMFANG: RANGE OF FUNCTIONS:

Direktes Dimmen einzelner Strahler/ Direct dimming of individual spotlights
Dimmen in Szenen/ Dimming in scenes
iBeacon

Gateway bei zeitgesteuerten Abläufen notwendig
For time controlled scenes a gateway is necessary

MOLTO LUCE SMART APP



Die Molto Luce Smart APP ist ihr System zur Lichtsteuerung, egal ob einzelne Gruppen, ganze Netzwerke, Szenen, Zeitsteuerungen und komplexe Lösungen wie Heatmapping. Die Molto Luce Smart APP stellt ihnen alle Möglichkeiten zur Verfügung.

DOWNLOAD IM APP ODER PLAY STORE

The Molto Luce Smart App is your system for lighting control, whether individual groups, entire networks, scenes, time schedules, or complex solutions like Heatmapping. The Molto Luce Smart APP offers you all possibilities.

DOWNLOAD IN APP OR PLAY STORE



**SMART APP BEDIENUNGSANLEITUNG:
SMART APP INSTRUCTION MANUAL:**



CONNECTIVITY

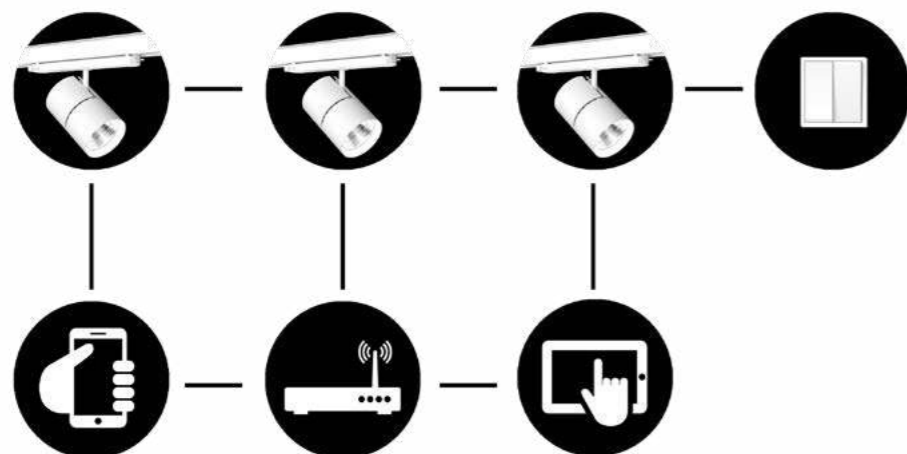

DARK REFLECTOR

Die nächste Generation an Reflektoren kombiniert Design mit verbessertem Farbwiedergabewert für ein optimales Einkaufserlebnis. The next generation of reflectors combines design with an enhanced colour rendering index for an ideal shopping experience.

Perfekte Entblendung / Perfect Glare Control

Der DARK-Reflektor ist mit einer speziellen, von Molto Luce entwickelten Beschichtung veredelt, die in Kombination mit Mikro-Facetten des Reflektors für eine perfekte Entblendung sorgt.

The DARK-Reflector is finished with a special coating, developed by Molto Luce, which in combination with micro-facets of the reflector ensures perfect glare control.



Erhöhung des Farbwiedergabewertes / Increasing Colour Rendering Index

Zusätzlich sorgt diese spezielle Beschichtung für eine Erhöhung des Farbwiedergabewertes (CRI) um 4% im Vergleich zu einer Standard Aluminium Beschichtung. Der Vorteil eines erhöhten CRI ist, dass die Ware farbtreu, fast wie unter Sonnenlicht, wiedergegeben wird.

In addition, this special coating increases the color rendering index (CRI) by 4% compared to a standard aluminum reflector. The advantage of an increased CRI is that the goods are rendered true to colour.



Mehr Rotlicht / More Red light

Die Darstellung des Spektrums zeigt den Unterschied zwischen dem Dark-Reflektor und einem herkömmlichen Reflektor. Wie man gut erkennen kann, wird durch den Dark-Reflektor der Rotlichtanteil um 10% erhöht.

The display of the spectrum shows the difference between the dark reflector and a conventional reflector. As you can clearly see, the dark reflector increases the proportion of red light by 10%.

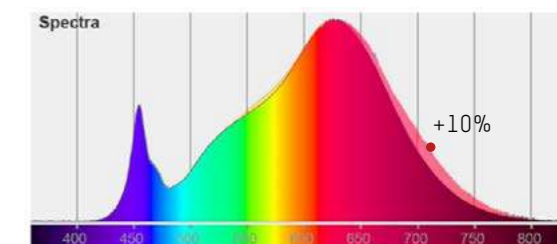

Einsatzbereiche / Areas of application

In Kombination mit der perfekten Entblendung und dem einzigartigen Kalt- und Warmerscheinungsbild, ist der DARK-Reflektor die perfekte Beleuchtungslösung für Einsatzbereiche wie Shops, welche Lederartikel wie zum Beispiel Handtaschen oder auch Schmuck anbieten. Im Architekturbereich kann durch den Einsatz des DARKReflektors eine neuartige Lichtstimmung geschaffen werden, was besonders in Restaurants oder Bars eine essentielle Rolle spielt. Durch die dunkle Beschichtung wird zwar circa 40% des Lichtes absorbiert, allerdings schafft dies gerade in diesen Anwendungsbereichen eine stimmungsvolle Umgebung. Eine weitere Besonderheit des DARK-Reflektors ist, dass man die Lichtpunkte durch die spezielle dunkle Beschichtung nicht wahrnimmt und nur schwer ausmachen kann, woher das Licht stammt. Der Reflektor erscheint im ON- sowie im OFF-Zustand annähernd gleich, daher erkennt man den Unterschied erst bei direktem Blick in die Lichtquelle.

In combination with the resulting perfect glare control and the unique cold and warm appearance, the DARK-Reflector is the perfect lighting solution for shops that offer leather items, handbags or jewellery. The DARK-Reflector with its specific light is a perfect solution in the architectural field in order to create an optimal atmosphere for example in restaurants or bars. Although the dark coating absorbs around 40% of the light, this is exactly what is needed in order to create the perfect mood. Another innovation of the DARK-Reflector is that with the special, dark coating the luminaries cannot be seen, and it is difficult to perceive where the light comes from. The reflector almost seems alike, no matter if it is switched on or off. The real difference can only be detected by looking directly into the light source.

BINNING

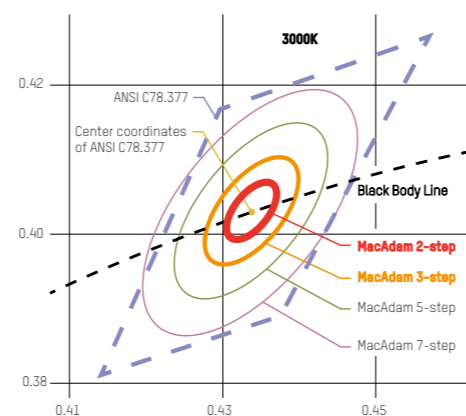

Produktionsbedingt gibt es bei der Herstellung von LEDs immer kleine Unterschiede in Lichtfarbe, Farbwiedergabe und Helligkeit der einzelnen LEDs. Diese Unterschiede würden im Vergleich mehrerer gleicher Produkte auffallen. Um dies zu vermeiden gibt es das sogenannte Binning. Bei dieser Sortierung werden alle LEDs einzeln getestet und in Gruppen, sogenannte Bins sortiert. Ein Bin enthält nur LEDs mit gleichen Werten. Dieser Binning-Prozess wird anhand der MacAdam Ellipse durchgeführt. Diese Ellipse definiert jenen Bereich, in dem keine Unterschiede für den Menschen wahrnehmbar sind. Entsprechend dem Stand der Technik werden bei Molto Luce Produkten ausschließlich LEDs führender Hersteller mit MacAdam (SDCM) 3Step Binning verbaut.

COB - CHIP ON BOARD

Bei COB Modulen werden die LED-Chips direkt auf wärmeleitendes Material (Board) geklebt und mittels dünnen Golddrähten elektrisch miteinander verbunden. Um den mechanischen Schutz der Bauteile zu gewährleisten und weißes Licht erzeugen zu können, wird diese Anordnung danach mit einem Silikon-Phosphor-Gemisch stabilisiert. Ein wesentlicher Vorteil dieser Technologie liegt im verbesserten Wärmeübergang der LED-Chips auf den Kühlkörper (geringerer thermischer Widerstand). Ein optimiertes Wärmemanagement verbessert in der Folge unmittelbar Lebensdauer und Farbdrift der Chips. Mehrere LED-Chips können so auf einer kleinen Fläche untergebracht und kollektiv enorme Lichtströme erzeugt werden.



STANDARDLEBENSDAUER

L80/B10 50.000h Ta max=25°C

80% Restlichtstrom nach 50.000 Stunden Betrieb, unterschritten von max. 10% der Leuchten der Testreihe.
Bestimmungsgemäßer Betrieb der Leuchte bei max. 25°C Umgebungstemperatur (außer gesondert angegeben).

LICHTSTROM

Der gerechnete Lichtstrom der Leuchte wird unter Berücksichtigung aller Verminderungsfaktoren wie Temperatur, Reflektorwirkungsgrad, Schutzglas-Transmissionswert und konstruktiven Faktoren, gemäß der technischen Datenblätter und Herstellerangaben, ausgewiesen. Die im Katalog angeführten, berechneten Werte beziehen sich, wenn nicht anders angegeben, auf eine Referenzberechnung mit folgender Spezifikation: 3000K CRI 80 bei Ta=25°C

LEISTUNGSANGABEN

Im Katalog wird ausschließlich die Systemleistung (SYS) angegeben, d.h. die aufgenommene Gesamtleistung von Leuchtmittel plus der Leistung des (LED) Betriebsgerätes. Ausnahmen sind nur Leuchten die ohne Betriebsgerät geliefert werden, hier wird die LED Leistung (LED) angegeben.

Die zum Zeitpunkt der Drucklegung des Katalogs verfügbaren Daten sind teilweise berechnete Werte. Die Leuchten werden nach dem Stand der Technik laufend optimiert. Elektrische Leistungsangaben sowie Lumenwerte unterliegen einer Toleranz von +/- 10%. Durch ein zertifiziertes Institut gemessene Werte sind nach aktuellem Stand in den Produktinformationen auf www.moltoluce.com und in der Lichtplanungssoftware DIALux zu finden.

Sämtliche Inhalte in diesem Katalog entsprechen dem Stand bei Drucklegung und dienen ausschließlich zu Informationszwecken. Molto Luce behält sich das Recht vor, jederzeit und ohne Ankündigung die technischen Daten der im Katalog abgebildeten Produkte zu modifizieren. Für Farbabweichungen übernehmen wir keinerlei Haftung. Manche der im Prospekt abgebildeten Produkte sind Bildretuschen und dienen zur Veranschaulichung der Einsatzmöglichkeiten. Unsere allgemeinen Geschäfts- und Lieferbedingungen können unter www.moltoluce.com eingesehen werden.

BINNING

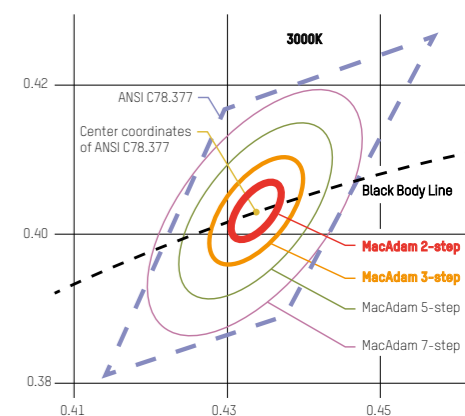

In the manufacture of LEDs, there are always small differences in the colour of the light, colour rendering and brightness of the individual LEDs. These differences would be noticeable when comparing several identical products. To avoid this, there is the so-called BINNING. Binning allows LEDs to be tested individually and separated into single groups, called BINS. A BIN contains only LEDs with the same values. This binning process is performed using the MacAdam ellipse. This ellipse defines the area where differences are not perceptible for humans. Accordingly, our products only use LEDs with MacAdam (SDCM) 3step Binning.

COB - CHIP ON BOARD

In COB modules, the LED chips are glued directly on a thermo-conducting board, and are electrically connected to each other through thin gold wires. In order to ensure the mechanical protection of the components and to produce white light, this structure is stabilized with a silicone-phosphor mixture. An important advantage of this technology lies in the improved heat transfer of the LED chips to the cooling element (lower thermal resistance). Subsequently, an optimized heat management leads directly to an improvement of lifetime and colour drift of the chips. Thus, several LED chips can be placed in a small area and enormous light streams can be collectively generated.



STANDARD LIFETIME

L80/B10 50.000h Ta max=25°C

80% residual output after 50.000 hours of operation for at least 90% of the tested luminaires.
Lamp operated as intended at max. 25° ambient temperature (unless specifically stated)

LUMINOUS FLUX

The projected luminous flux of the lamp is shown in consideration of all reduction factors such as temperature, reflector efficiency, safety glass transmittance value and constructive factors according to the technical data sheets and manufacturer's instructions. The specified, calculated values in the catalogue refer to, unless otherwise specified, a reference calculation with the following specifications: 3000K CRI 80 at Ta = 25°C

POWER RATING

Only the system performance (SYS) is mentioned in the catalogue. This means the total absorbed power of LED plus the power of the Driver. Exceptions are only luminaires that are delivered without Driver, here the LED power (LED) is specified.

Available data at time of printing of the catalogue are partly calculated values. The lights are continuously optimized according to the latest technical development, all indicated power ratings and lumen outputs have a tolerance of +/- 10%, updated information can be found on www.moltoluce.com and the professional lighting planning software DIALux.

All details provided in the catalogue comply with available data at the time of publication, and are for information purpose only. Molto Luce has the right to change/modify technical data any time without prior information. Molto Luce is not liable for colour variation. Some of the pictures are retouched and are just to show installation possibilities. See Molto Luce's business conditions and delivery terms on www.moltoluce.com

LED RETROFIT	INFORMATION	FASSUNG	WATT	KELVIN	ENERGIEEFFIZIENZ	ART.NR.
LED RETROFIT	INFORMATION	SOCKET	WATT	CELVIN	ENERGYEFFICIENCY	CODE
	ST64 / MASTER VLE LED Bulb klar	E27	6W	927	D	30-347960
	A60 / CorePro LED Bulb klar	E27	4W	827	F	30-347168
	A60 / CorePro LED Bulb klar	E27	7W	827	E	30-380035
	G120 / MASTER VLE LED Bulb klar	E27	6W	927	D	30-347984
	A60 / MASTER VLE LED Bulb klar	E27	6W	922-927	D	30-324732
	G200 / Classic LED Bulb gold	E27	7W	818	F	30-313781

LED RETROFIT	INFORMATION	FASSUNG	WATT	KELVIN	ENERGIEEFFIZIENZ	ART.NR.
LED RETROFIT	INFORMATION	SOCKET	WATT	CELVIN	ENERGYEFFICIENCY	CODE
	A60 / Master LED Bulb mirror	E27	7,2W	827	E	30-361225

LED RETROFIT	INFORMATION	FASSUNG	WATT	KELVIN	ENERGIEEFFIZIENZ	ART.NR.
LED RETROFIT	INFORMATION	SOCKET	WATT	CELVIN	ENERGYEFFICIENCY	CODE
	A60 / Master LED Bulb clear	E27	6W	822-827	F	30-306301
	A60 / Master LED Bulb matt	E27	7W	922-927	D	30-324930
	A60 / Master LED Bulb matt	E27	11W	922-927	D	30-325012

LED RETROFIT	INFORMATION	FASSUNG	WATT	KELVIN	ENERGIEEFFIZIENZ	ART.NR.
LED RETROFIT	INFORMATION	SOCKET	WATT	CELVIN	ENERGYEFFICIENCY	CODE
	B35 / CorePro LED Candle	E14	2W	827	E	30-377578
	CorePro LED Luster	E14	2W	827	E	30-347748

LED RETROFIT	INFORMATION	FASSUNG	WATT	KELVIN	ENERGIEEFFIZIENZ	ART.NR.
LED RETROFIT	INFORMATION	SOCKET	WATT	CELVIN	ENERGYEFFICIENCY	CODE
	B38 / Master LED Candle clear	E14	3W	822-827	F	30-306028
	B38 / Master LED Candle clear	E14	6W	822-827	F	30-306141
	P48 / Master LED Luster clear	E14	3W	822-827	F	30-306066
	P48 / Master LED Luster clear	E14	6W	822-827	F	30-306189

LED RETROFIT	INFORMATION	FASSUNG	WATT	KELVIN	ENERGIEEFFIZIENZ	AUSSTRAHLWINKEL	ART.NR.
LED RETROFIT	INFORMATION	SOCKET	WATT	CELVIN	ENERGYEFFICIENCY	BEAM ANGLE	CODE
	Core Pro LED Spot	GU10	4W	827	F	36	30-752531
	Master LED Spot VLE	GU10	4W	827	F	36	30-312289
	Master LED Spot Expert Colour	GU10	4W	922-927	G	25	30-707517
	Master LED Spot Expert Colour	GU10	4W	930	G	36	30-707579
	Master LED Spot Expert Colour	GU10	5W	922-927	F	36	30-708118
	MASTER LED SPOT VLE	GU10	6W	930	G	25	30-707630
	Master LED Spot Expert Colour	GU10	6W	930	G	36	30-707692
	Core Pro LED Spot	GU10	5W	827	F	36	30-752517

COLLECTED EDITION

conception and graphic design
Joachim Rauch, Molto Luce GmbH

Ein herzliches Danke gilt all unseren Partnern, die uns bei der Realisierung dieses Kataloges unterstützt haben. Insbesondere auch jenen Firmen und Architekten, die uns aussagekräftige Projektfotos zur Verfügung gestellt haben.

Sämtliche Inhalte in diesem Katalog entsprechen dem Stand bei Drucklegung und dienen ausschließlich zu Informationszwecken. Molto Luce behält sich das Recht vor, jederzeit und ohne Ankündigung die technischen Daten der im Katalog abgebildeten Produkte zu modifizieren. Für Farbabweichungen übernehmen wir keinerlei Haftung. Manche der im Prospekt abgebildeten Produkte sind Bildretuschen und dienen zur Veranschaulichung der Einsatzmöglichkeiten. Unsere allgemeinen Geschäfts- und Lieferbedingungen können unter www.moltoluce.com eingesehen werden.

A word of thanks to all of our partners who helped with the support and realisation of this catalogue. In particular with regards to the companies and architects who provided their project photos.

All details provided in the catalogue comply with available data at the time of publication, and are for information purpose only. Molto Luce has the right to change/modify technical data any time without prior information. Molto Luce is not liable for colour variation. Some of the pictures are retouched and are just to show installation possibilities. See Molto Luce's business conditions and delivery terms on www.moltoluce.com

MOLTO LUCE
on social media



FACEBOOK



INSTAGRAM



LINKEDIN



PINTEREST



YOUTUBE

LIGHT & ROOM by MOLTO LUCE

Inspirations for Roomconcepts | Lightdesign | Architecture | Lifestyle



FACEBOOK



INSTAGRAM



LINKEDIN

WEBSITE
www.moltoluce.com

