





Una luce per dare calore, una luce per dare attenzione, una luce per perdersi nei propri pensieri. Ogni riflesso, uno stato d'animo.

Affascinato dalle infinite sfaccettature della luce, il brand TOOY propone un'illuminazione che dona valore all'esperienza dell'abitare gli spazi attraverso un'ampia e versatile gamma di prodotti capaci di raccontare una storia.

Semplici ed estremamente sofisticati al contempo, i complementi TOOY si spingono oltre i confini del décor con un'identità forte e connotata che si esprime con eloquenza nei contesti domestici e contract.

Presieduto da Valeria Giacomozzi e Valerio Tidei, il brand TOOY persegue la ricerca dell'equilibrio perfetto tra valenza estetica e funzionalità. E lo fa in modo unico, con sguardo fresco, individuando i più interessanti trend a livello globale per tradurli nel celebre "saper fare" che ha fatto grande il Made in Italy nel mondo.

REFLECTIONS OF STYLE.

A light to give warmth, a light to give attention, a light to get lost in one's thoughts. Each reflection, a state of mind.

Fascinated by the infinite facets of light, the TOOY brand offers lighting that gives value to the experience of living in spaces through a wide and versatile range of products capable of telling a story.

Simple and extremely sophisticated at the same time, TOOY accessories go beyond the boundaries of décor with a strong and distinctive identity that is expressed with eloquence in domestic and contract contexts.

Chaired by Valeria Giacomozzi and Valerio Tidei, the TOOY brand pursues the perfect balance between aesthetic value and functionality. And it does so in a unique way, with a fresh look, identifying the most interesting global trends to translate them into the famous "know-how" that made "Made in Italy" great in the world.





1AM

2AM



3AM

4AM

5AM

6AM

7AM

8AM

9AM

10AM

11AM

12PM

1PM

2PM

3PM

4PM

5PM

6PM

7PM

8PM

9PM

10PM

11PM

12AM

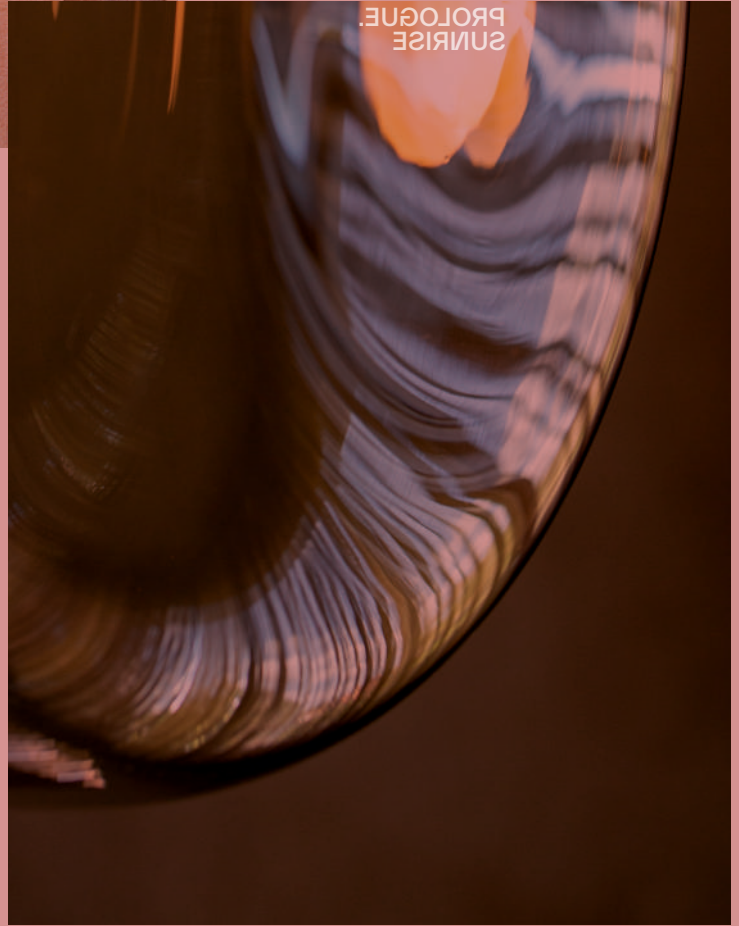

PROLOGO.
SUNRISE

LEGIER 557.34

Non sapeva da quanto tempo fosse lì. Solo, vestito di tutto punto, davanti allo specchio. Un tentativo di luce gli attraversava il volto: doveva essere l'alba.

La casa, un luogo che non riconosceva. La esplorò con lo sguardo: ampie aperture su un giardino, una poltrona, una lampada accesa, lungo le pareti installazioni e quadri. Li aveva scelti lui? Non lo sapeva. Non lo sapeva più.

Si sforzò di ricordare perché fosse lì. Mentre la luce giallo-oro del giorno invadeva quel suo personale limbo, cercò conforto nel rovistare: non lo trovò.

Ciò che abitava la casa esercitava su di lui un richiamo alieno. Aveva mai vissuto quegli oggetti, erano mai stati suoi? Non era in grado di dirlo. Fece per uscire dalla casa: la porta era chiusa. Le chiavi, non pervenute.

“Specchio, specchio delle mie brame, chi è il più cretino del reame?” chiese al proprio riflesso alla finestra.

PROLOGUE.
SUNRISE

He didn't know how long it had been there. Alone, fully dressed, in front of the mirror. An attempt of light crossed his face: it must have been dawn.

The house, a place he did not recognize. He explored it with his eyes: large openings on a garden, an armchair, a lighted lamp, installations and paintings along the walls. Had he chosen them? He didn't know. He didn't know anymore.

He struggled to remember why he was there. As the yellow-gold light of day invaded that personal limbo of his, he sought solace in rummaging: he did not find it.

What inhabited the house had an alien appeal to him. Had he ever lived those objects, had they ever belonged to him? He was unable to tell. He started to leave the house: the door was closed. The keys, not received.

“Mirror, mirror of my desires, who is the most dimwit in the realm?” he asked his reflection in the window.





NASTRO 563.61







OSMAN 560.34



NASTRO 563.32





MOLLY 556.71



EXCALIBUR 559.41







NASTRO 563.43
NABILA 552.41



NABILA 552.19





NABILA 552.12
NABILA 552.32



MOLLY 556.62









LEGIER 557.34





NABILA 552.21
NABILA 552.22





OSMAN 560.31
GORDON 561.31
GORDON 561.13ABC





THULA 562.43





NASTRO 563.41
OUTDOOR







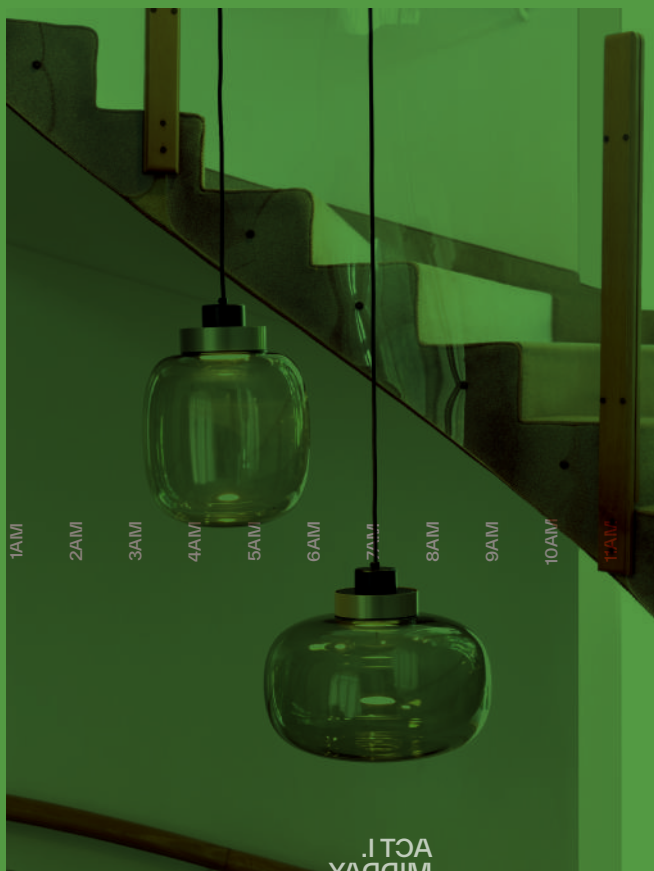

12PM
1PM
2PM
3PM
4PM
5PM
6PM
7PM
8PM
10PM
11PM
12AM



LEGIER 557.22
LEGIER 557.24

Qualcosa di familiare alla fine l'aveva trovato. Un cappello. Una ciotola in marmo. Ci si era fatto la fronte, da bambino, con il gentile contributo di una spinta del fratello. Era rimasta la cicatrice. La ripercorse con il dito, in uno specchio. *"Boys will be boys"*, doveva aver mormorato la governante. *"Boys will be held accountable for their actions"*, doveva aver corretto la madre, lo sguardo già altrove.

Dalla finestra, lo raggiunse un motivo swing che qualcun altro avrebbe potuto riconoscere. Guardò fuori: sole allo zenit, ombre annientate su uno scenario a lui straniero.

"Quando non hai nulla da fare, balla": questa doveva essere stata Granny, un'esperta nell'arte del non aver nulla da fare. Prese il cappello da terra e se lo sistemò di tre quarti, strizzando l'occhio al suo riflesso nella finestra.

Accennò un passo di danza, e se ne compiacque. Allora ballò, e ballò ancora, piroettando tra i tavoli, duettando con le sedie, sempre più veloce, scomposto, e quando infine crollò su una poltrona la musica era finita da un pezzo.

Si calò il cappello sugli occhi, rovesciò la testa all'indietro e si assopì senza accorgersi che la sua immagine riflessa alla finestra era rimasta immobile, a guardarlo.

ACT I. MIDDAY

Finally, he found something familiar. A hat. A marble bowl, hit his forehead as a child, with the kind contribution of a push from his brother. The scar remained. He traced it with his finger, in a mirror. *"Boys will be boys"*, the housekeeper must have murmured. *"Boys will be held accountable for their actions"*, must have corrected his mother, her gaze already elsewhere.

From the window, a swing tune reached him that someone else might have recognized. He looked out: sun at the zenith, shadows vanished on a scene foreign to him.

"When you have nothing to do, dance": this must have been Granny, an expert in the art of having nothing to do. He took the hat off the ground and adjusted it by three quarters, winking at his reflection in the window.

He hinted at a dance step, and was pleased with it. Then he danced, and danced again, twirling between the tables, duelling with the chairs, faster and faster, sprawled, and when he finally collapsed into an armchair the music was long over.

He lowered the hat over his eyes, threw his head back and dozed off without realizing that the image of his reflected in the window had remained motionless, looking at him.





OSMAN 560.42
OSMAN 560.16







NABILA 552.66
MUSE 554.35





GORDON 561.24
GORDON 561.21
GORDON 561.22

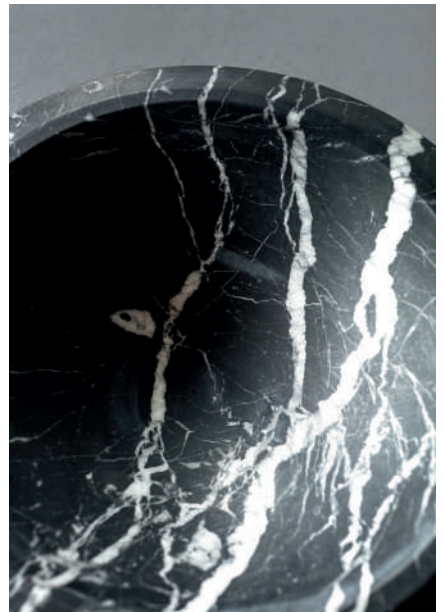

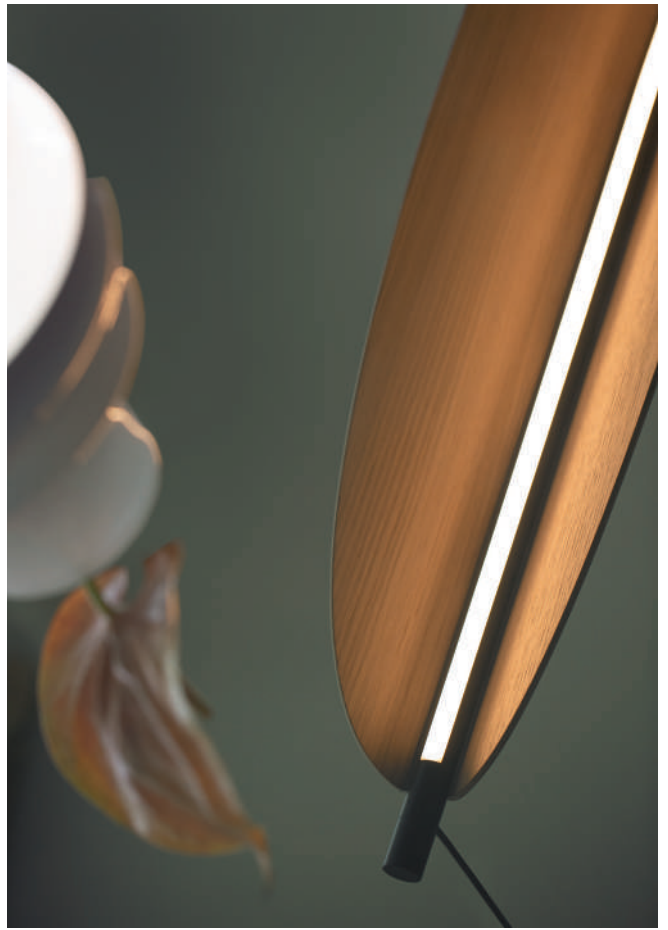

THULA 562.23

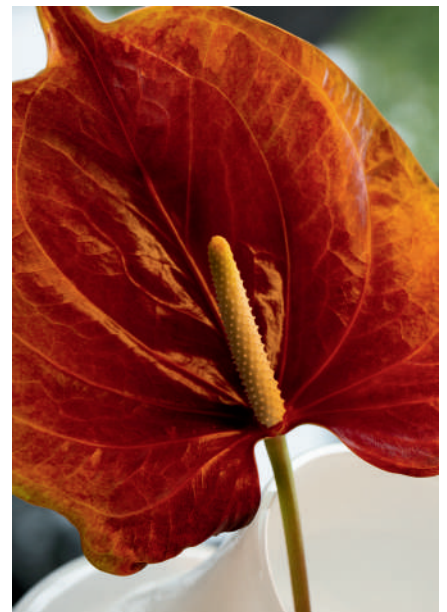







MACAO 551.32
MOLLY 556.21
MOLLY 556.22
MOLLY 556.23







MOLLY 556.21
MOLLY 556.22
MOLLY 556.23
MACAO 551.32





LEGIER 557.26









NABILA 552.16
NABILA 552.10

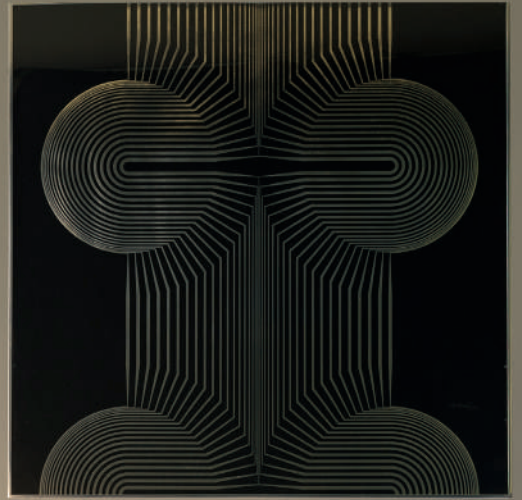



LEGIER 557.34







NASTRO 563.62
OUTDOOR



MACAO 551.64



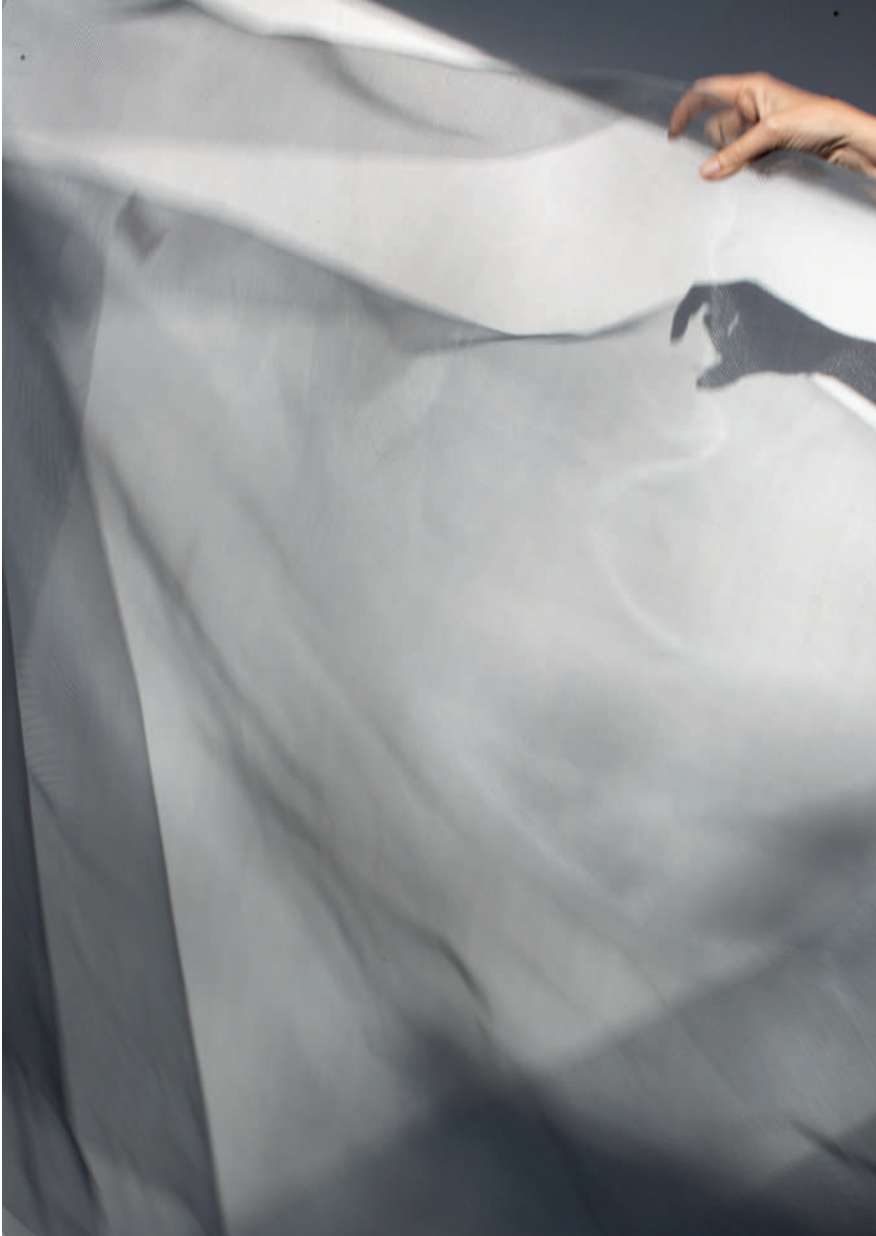

1AM

2AM

3AM

4AM

5AM

6AM

7AM

8AM

9AM

10AM

11AM

12PM

1PM

2PM

3PM

4PM

5PM

6PM

7PM

8PM

10PM

11PM

12AM



ACT II.
SUNSET



GORDON 561.48

ATTO II.
TRAMONTO

Al risveglio, le lunghe ombre del tendaggio smosso dal vento lambivano il mobilio, si distorcevano, scivolavano via, si allungavano per vestire di buio ciò che toccavano. Quella vista lo rese inquieto.

Si guardò intorno. Ampie aperture su un giardino, una poltrona, una lampada accesa, installazioni e quadri: li aveva scelti lui? Seppe di essersi già posto quella domanda, senza ricordare quando. Ciò lo turbava, lo turbava più del non rammentarsi il proprio nome – perché non ricordava più neanche quello.

Si ritirò davanti a uno specchio. Un accenno di barba, una vecchia cicatrice sulla fronte, chissà come se l'era fatta. Cercò di riconoscersi in quei tratti, in quelle rughe, in una smorfia: non ci riuscì. Sentì l'impulso di ballare.

Che idea bizzarra, ballare in quella situazione, cosa gli veniva in mente. Si strofinò il volto con forza crescente: era reale, quel corpo senza ricordi?

Sommerso dall'insofferenza, fece per colpire lo specchio: il suo riflesso schivò il colpo con un sorriso beffardo.

ACT II.
SUNSET

Upon awakening, the long shadows of the wind-blown curtain changed the furniture, distorted, slipped away, stretched to dress what they touched in darkness. The sight made him restless.

He looked around. Wide openings onto a garden, an armchair, a lighted lamp, installations and paintings: had he chosen them? He knew he had asked himself that question before, without remembering when. It troubled him, it troubled him more than not remembering his own name - because he didn't even remember his name anymore.

He withdrew in front of a mirror. A hint of a beard, an old scar on his forehead, who knows how he got it. He tried to recognize himself in those features, in those wrinkles, in a grimace: he could not. He felt the urge to dance.

What a bizarre idea, dancing in that situation, what came to mind. He rubbed his face with increasing force: was it real, that body without memories?

Overwhelmed by the unfulfilled, he hit the mirror: his reflection dodged the punch with a mocking smile.







MUSE 554.14





NASTRO 563.22







NASTRO 563.64

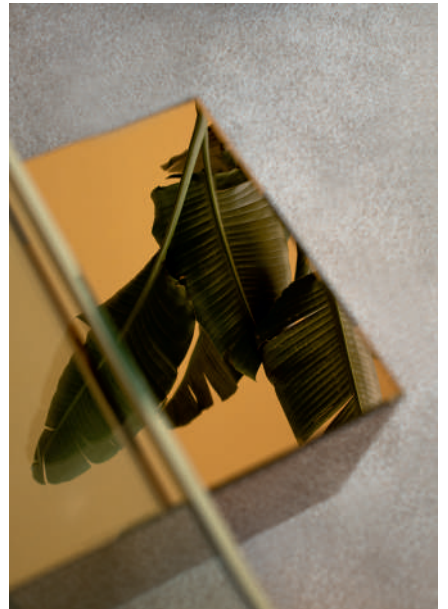

NASTRO 563.64





BILANCELLA 512.21





THULA 562.42





THULA 562.48



LEGIER 557.32
FILIPA 555.31





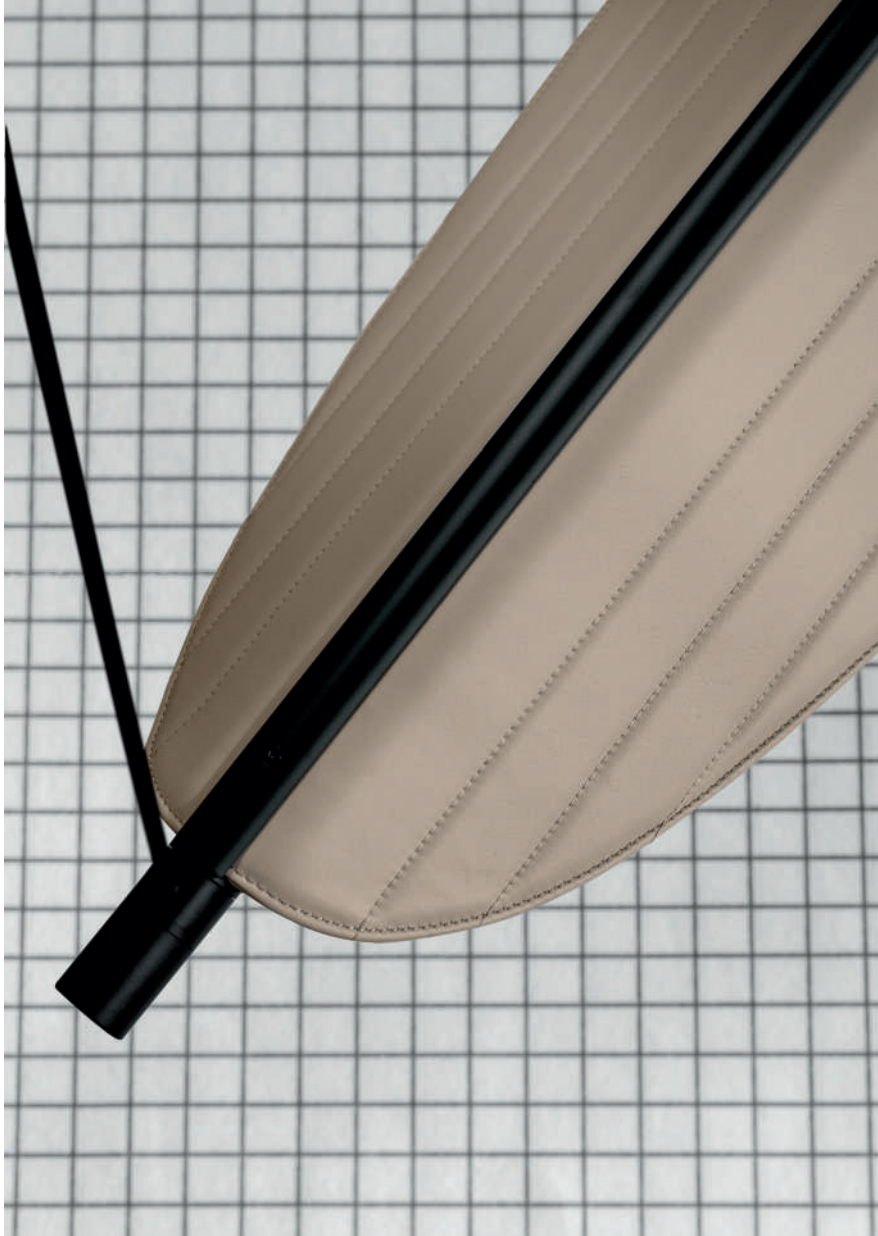

THULA 562.21
THULA 562.22



NABILA 552.33
FILIPA 555.22





MEZZANOTTE OTTO III.



2AM

3AM

4AM

5AM

6AM

7AM

8AM

9AM

10AM

11AM

12PM

1PM

2PM

3PM

4PM

5PM

6PM

7PM

8PM

10PM

11PM

12AM

ACT III.
MIDNIGHT

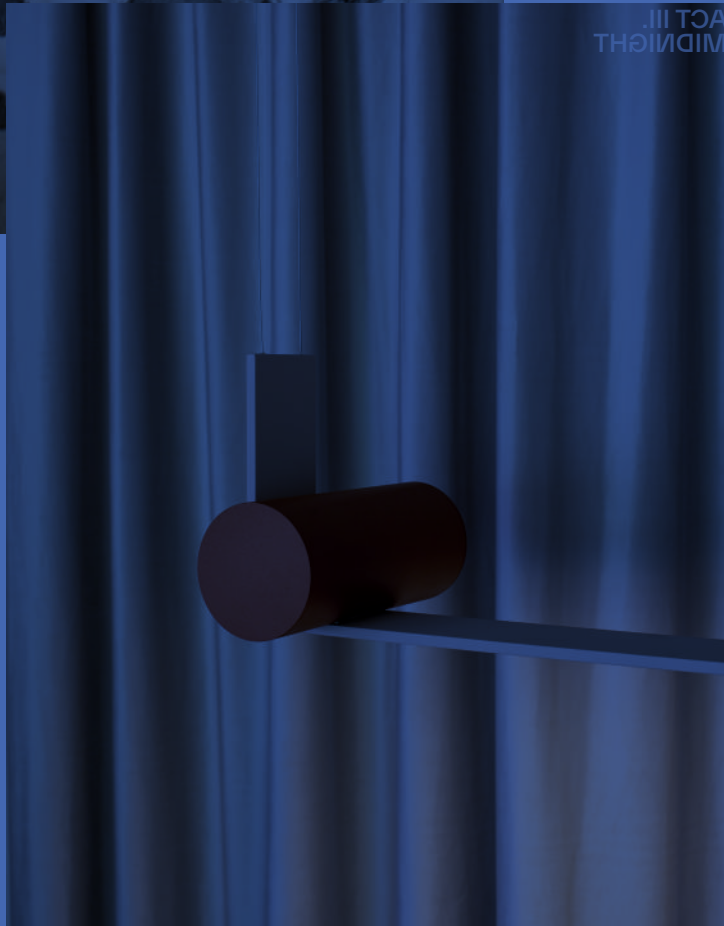

NASTRO 563.21

La sua immagine riflessa non gli ubbidiva più. Braccio in fuori: braccio in alto. Dito sul naso: dito sulla tempia.

“Smettila” le sputò. “No”, mimò lei, muta. Frustrato, si abbandonò su una chaise-longue. Il suo riflesso alla porta-finestra vi si sedette invece con calma, accomodandosi, accavallando le gambe. Si spiò nella lucida superficie di un tavolino: l'espressione del riflesso lo indignava.

Cosa c'era in quello sguardo? Derisione? “Cosa vuoi?” mormorò alla fine allo specchio. Intravide un cenno della testa. Era un invito? “Vuoi che venga lì?” - rise - “E come ci vengo, lì?” Il suo riflesso si alzò, si avvicinò al bordo del vetro e gli tese una mano. “Certo, come no.” L'immagine alzò un sopracciglio: disappunto. Ah, era una sfida.

Allora si alzò, avvicinandosi a braccia tese, il riflesso che arretrava per accoglierlo, un passo ancora, un altro passo ed ecco, le dita scivolavano nello specchio, un ultimo passo, ancora, e il vetro lo sommerse.

Era dall'altra parte.

Non sapeva da quanto tempo si trovasse lì. Solo, vestito di tutto punto, davanti allo specchio.

ACT III. MIDNIGHT

The reflection of himself no longer obeyed him. Arm out: arm up. Finger on the nose: finger on the temple.

“Stop it,” he spat at it. “No,” it mumbled, silent. Frustrated, he indulged in a chaise-longue. The reflection of him in the French window instead sat calmly, making himself comfortable, crossing its legs. He spied on the shiny surface of a table: the expression of his reflection indignant him.

What was there in that look? Derision? “What do you want?” he finally murmured at the mirror. He caught a glimpse of his head. Was it an invitation? “Do you want me to come there?” - he laughed - “And how do I get there?” His reflection lifted, moved to the edge of the glass, and held out a hand. “Sure, why not.” The image raised an eyebrow: disappointment. Ah, it was a challenge.

Then he stood up, approaching with outstretched arms and, the reflection retreated to welcome him, one more step, another step and behold, the fingers slipped into the mirror, one last step, again, and the glass submerged him.

He was on the other side.

He didn't know how long he had been there. Alone, fully dressed, in front of the mirror.







GORDON 561.61



TOOY





OSMAN 560.17
OSMAN 560.21









NASTRO 563.11









NASTRO 563.21



NASTRO 563.31









THULA 562.41





MUSE 554.13





MUSE 554.13







NABILA 552.48







1AM
2AM
3AM
4AM
5AM
6AM
7AM
8AM
9AM
10AM
11AM
12PM
1PM
2PM
3PM
4PM
5PM
6PM
7PM
8PM
10PM
11PM
12AM

TECHNICAL
SHEETS



TECHNICAL
SHEETS

Colori/Colors

IT Il codice colore sotto l'immagine si riferisce al colore dell'articolo fotografato. I colori standard disponibili sono mostrati nelle pagine "technical info". I colori degli articoli illustrati sono riprodotti il più fedelmente possibile, compatibilmente con i limiti tecnici della stampa e sono suscettibili di piccole variazioni di tonalità. Colori "custom" sono disponibili su richiesta su tutte le collezioni ad un costo aggiuntivo.

ENG The colour-code under each image is related to the colour of the photographed article. The available standard colours are shown on technical info pages. The colours of the illustrated articles are reproduced the most faithfully possible, in line with the technical limits of printing and small variations of tone are possible. Custom colors are available upon request across all collections at an additional cost.



C2
Nero opaco
Matte black

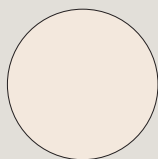

C22
Beige
Beige

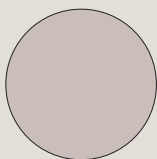

C23
Guscio d'uovo
Eggshell

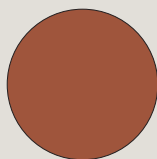

C25
Terracotta
Terracotta

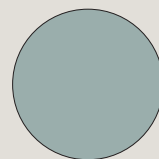

C26
Grigio-verde
Greenish-grey

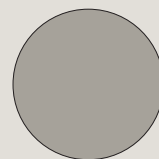

C30
Grigio luce
Light grey

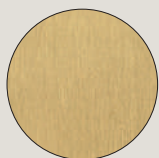

C41
Ottone spazzolato
Brushed brass

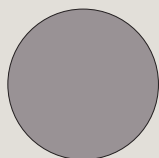

C46
Grigio sabbia
Sand grey



C48
Cromo nero
Black chrome



C50
Peltro
Pewter

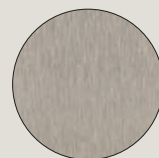

C68
Nichel satinato
Satin nickel



C74
Nero sabbia
Sand black

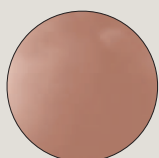

C99
Rame
Copper

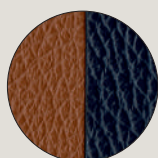

L01
Pelle bicolore
Two-tone leather

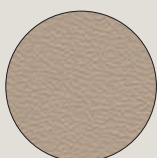

L02
Pelle Beige
Beige leather

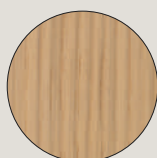

W01
Frassino
Ash

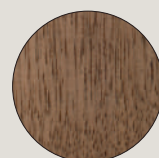

W02
Noce Canaletto
Canaletto walnut

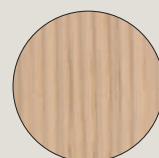

W03
Rovere chiaro
Light oak



M01
Cemento
Concrete

505 Quadrante
Designed by Roberto Giacomucci

IT Sospensioni modulari realizzati con tubi di acciaio saldati e verniciati a polveri epossidiche.
Le configurazioni possibili sono numerose e creano un sistema di griglie luminose nell'ambiente.

ENG Modular suspension made of welded and powder coated steel pipes.
The possible configurations are numerous and create a system of bright grids.

505.08 Chandelier

Hardware

CE \oplus IP 20

Light source 8 x G9 220/240V
Wattage (LED) Max 10W
Dimmability According to bulb
Dimensions L92/W33/H12 cm
Cable Steel
Length 125 cm

C2 Matte black

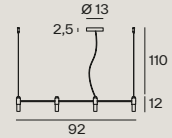

505.09 Chandelier

Hardware

CE \oplus IP 20

Light source 9 x G9 220/240V
Wattage (LED) Max 10W
Dimmability According to bulb
Dimensions L63/W63/H12 cm
Cable Steel
Length 125 cm

C2 Matte black

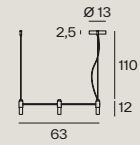

505.12 Chandelier

Hardware

CE \oplus IP 20

Light source 12 x G9 220/240V
Wattage (LED) Max 10W
Dimmability According to bulb
Dimensions L151/W33/H12 cm
Cable Steel
Length 125 cm

C2 Matte black

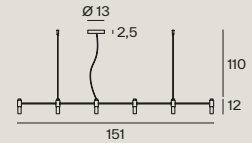

505.16 Chandelier

Hardware

CE \oplus IP 20

Light source	16 x G9 220/240V
Wattage (LED)	Max 10W
Dimmability	According to bulb
Dimensions	L92/W92/H12 cm
Cable	Steel Length 125 cm

C2 Matte black

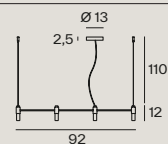

505.25 Chandelier

Hardware

CE \oplus IP 20

Light source	25 x G9 220/240V
Wattage (LED)	Max 10W
Dimmability	According to bulb
Dimensions	121/W121/H12 cm
Cable	Steel Length 125 cm

C2 Matte black

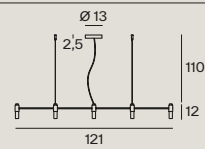

512 Bilancella
Designed by Roberto Giacomucci

IT Lampada a sospensione, soffitto e parete con diffusore in metallo verniciato a polveri epossidiche di spessore molto sottile. La versione decentrata, presenta un sistema di fissaggio a soffitto versatile che permette di illuminare anche in assenza di punti luce predisposti a soffitto. I decentratori in metallo infatti, permettono al filo elettrico di scorrere per portare la luce dove occorre. Grazie alla sua essenziale forma, la luce si diffonde uniformemente in tutto l'ambiente.

ENG Suspension, ceiling and wall lamp with a thin metal powder coated diffuser. The decentrate version has a versatile ceiling mounting system allowing to illuminate even in absence of electrical connection on the ceiling. In addition, the metal decentralizers allow the wire to slide to bring the light where it is needed. Thanks to its essential form, the light spreads evenly throughout the environment.

512.21 Pendant

Hardware

CE  IP 40

Light source	LED 220/240V
Wattage	38W
Color temperature	2700K
Lumens	3000
Dimensions	Ø50/H3 cm
Cable	Black fabric Length 150 cm

C74 Sand black



512.22 Pendant

CE  IP 40

Light source	LED 220/240V
Wattage	38W
Color temperature	2700K
Lumens	3000
Dimensions	Ø50/H3 cm
Cable	Black fabric Length 800 cm

C74 Sand black

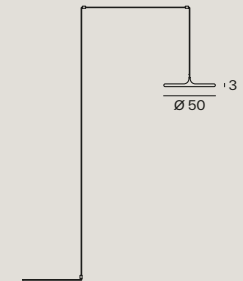

512.71 Wall/Ceiling

CE  IP 40

Light source	LED 220/240V
Wattage	38W
Color temperature	2700K
Lumens	3000
Dimensions	Ø50/H3/D6 cm

C74 Sand black

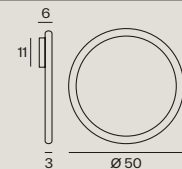

551 Macao
Designed by Corrado Dotti

IT Famiglia di lampade che reinterpretano le tradizionali lanterne giapponesi, dal gusto minimale ed elegante, declinata in quattro versioni che si adattano in diversi ambienti, piantana in doppia versione, tavolo e parete. La struttura è in metallo verniciata a polveri epossidiche e i paralumi in tessuto a rete bianca o nero. Leggerezza, minimalismo ed essenzialità caratterizzano lo stile di questa collezione.

ENG Collection of lamps revisiting traditional Japanese lanterns, characterized by a minimal and elegant style and available in four versions for any environment, floor (in two varieties) or wall and table. The structure is made by metal painted with epoxy powders, with white or black mesh lampshades. Lightness, minimalism and essentiality are the main traits of this collection.

551.32 Table

Hardware + Fabric

CE  IP 20

Light source 1 x E27 220/240V
Wattage (LED) Max 15W
Dimensions Ø24/H50 cm
Cable Black fabric
Length 150 cm

C74 Sand black + White Fabric

C74 Sand black + Beige Fabric and black net



551.32d Integrated dimmer on cable

551.44 Wall

Hardware + Fabric

CE  IP 20

Light source 1 x E27 220/240V
Wattage (LED) Max 15W
Dimmability According to bulb
Dimensions L35/H23/D15 cm

C74 Sand black + White Fabric

C74 Sand black + Beige Fabric and black net



551.64 Floor

Hardware + Fabric

CE  IP 20

Light source 1 x E27 220/240V
Wattage (LED) Max 20W
Dimensions Ø52/H150 cm
Cable Black fabric
Length 300 cm

C74 Sand black + White Fabric

C74 Sand black + Beige Fabric and black net

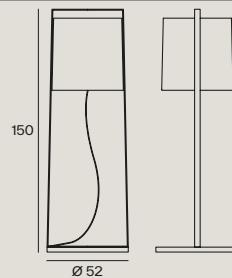

551.64d Integrated dimmer on cable

551.65 Floor

Hardware + Fabric

CE  IP 20

Light source 1 x E27 220/240V

Wattage (LED) Max 20W

Dimensions Ø52/H90 cm

Cable Black fabric
Length 300 cm



C74 Sand black + White Fabric



C74 Sand black + Beige Fabric and black net

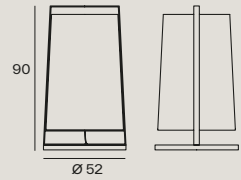

551.65d Integrated dimmer on cable

552 Nabila
Designed by Corrado Dotti

IT Ispirate alle lampade degli anni '50, eleganti e raffinate, rappresentano il dettaglio che arricchisce ogni ambiente. Sono caratterizzate da corpi luminosi sferici in vetro borosilicato a doppia parete proposte in varie composizioni, e una struttura in metallo verniciata a polveri epossidiche con dettagli in ottone spazzolato o cromo nero. Disponibile in diverse versioni per soddisfare le esigenze di ogni ambiente; dai ricchi chandeliers in cinque dimensioni differenti, alla versione da tavolo, comodino (più piccola), piantana o da parete, anche questa disponibile in modelli diversi per essere installata singolarmente o in composizioni personalizzate. Lusso e sobrietà in un unico elemento.

ENG 50s inspired collection of elegant and sophisticated lamps representing the detail to enrich any location. A double-sided spherical bright object in borosilicate glass makes these lamps available in different compositions and a structure made by metal coated with epoxy powder enriched with brushed brass or black chrome details. Different varieties are available for any situation: chandeliers (in five different models) or table lamp, bedside (smaller), floor or wall (available in three different models for single or composite personalized installation). Richness and sobriety all in one single element.

552.19 Chandelier

Hardware + Glass

UL CE IP 40

Light source	9 x G9 220/240V	
Wattage (LED)	Max 10W	C2 Matte black + C41 Brushed brass + Clear Glass
Dimmability	According to bulb	
Dimensions	Ø65/H35 cm	C2 Matte black + C48 Black chrome + Smoke Glass
Stem Kit (Adjusted on site)	30/60/90 cm	
Glass Ø	Included	
Note	12 cm	
	Custom stem on request (MIN 25 cm)	
	Max dimension bulb (excluded) Ø1,8/H5,7 cm	

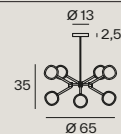

552.10 Chandelier

Hardware + Glass

UL CE IP 40

Light source	10 x G9 220/240V	
Wattage (LED)	Max 10W	C2 Matte black + C41 Brushed brass + Clear Glass
Dimmability	According to bulb	
Dimensions	L130/W60/H45 cm	C2 Matte black + C48 Black chrome + Smoke Glass
Stem Kit (Adjusted on site)	30/60/90 cm	
Glass Ø	Included	
Note	12/16 cm	
	Custom stem on request (MIN 25 cm)	
	Max dimension bulb (excluded) Ø1,8/H5,7 cm	

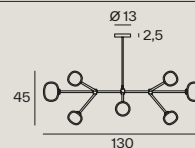

552.12 Chandelier

Hardware + Glass

UL CE IP 40

Light source	12 x G9 220/240V	
Wattage (LED)	Max 10W	C2 Matte black + C41 Brushed brass + Clear Glass
Dimmability	According to bulb	
Dimensions	Ø102/H43 cm	C2 Matte black + C48 Black chrome + Smoke Glass
Stem Kit (Adjusted on site)	30/60/90 cm	
Glass Ø	Included	
Note	12/16 cm	
	Custom stem on request (MIN 25 cm)	
	Max dimension bulb (excluded) Ø1,8/H5,7 cm	

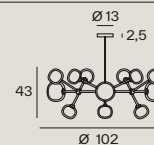

552.16 Chandelier

Hardware + Glass

UL CE IP 40

Light source	16 x G9 220/240V	
Wattage (LED)	Max 10W	C2 Matte black + C41 Brushed brass + Clear Glass
Dimmability	According to bulb	
Dimensions	Ø140/H58 cm	C2 Matte black + C48 Black chrome + Smoke Glass
Stem Kit (Adjusted on site)	30/60/90 cm	
Included		
Glass Ø	12/16 cm	
Note	Custom stem on request (MIN 25 cm) Max dimension bulb (excluded) Ø1,8/H5,7 cm	

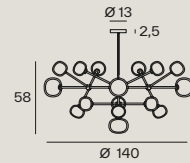

552.48 Chandelier

Hardware + Glass

CE IP 40

Light source	48 x G9 220/240V	
Wattage (LED)	Max 10W	C2 Matte black + C41 Brushed brass + Clear Glass
Dimmability	According to bulb	
Dimensions	Ø180/H148 cm	C2 Matte black + C48 Black chrome + Smoke Glass
Stem	Custom	
Glass Ø	12/16 cm	
Note	Max dimension bulb (excluded) Ø1,8/H5,7 cm	

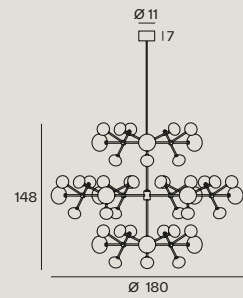

552.21 Pendant

Hardware + Glass

UL CE IP 40

Light source	1 x G9 220/240V	
Wattage (LED)	Max 10W	C2 Matte black + C41 Brushed brass + Clear Glass
Dimmability	According to bulb	
Dimensions	Ø12/H14,5 cm	C2 Matte black + C48 Black chrome + Smoke Glass
Cable	Black fabric Length 150 cm	
Glass Ø	12 cm	
Note	Max dimension bulb (excluded) Ø1,8/H5,7 cm	

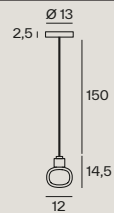

552.22 Pendant

Hardware + Glass

UL CE IP 40

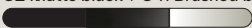
Light source	1 x G9 220/240V	
Wattage (LED)	Max 10W	C2 Matte black + C41 Brushed brass + Clear Glass
Dimmability	According to bulb	
Dimensions	Ø16/H17,5 cm	C2 Matte black + C48 Black chrome + Smoke Glass
Cable	Black fabric Length 150 cm	
Glass Ø	16 cm	
Note	Max dimension bulb (excluded) Ø1,8/H5,7 cm	

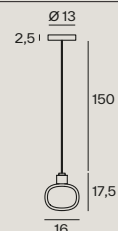

552.32 Side table

Hardware + Glass

CE IP 40

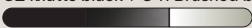
Light source	1 x G9 220/240V	
Wattage (LED)	Max 10W	C2 Matte black + C41 Brushed brass + Clear Glass
Dimensions	Ø16/H19 cm	
Cable	Black fabric Length 150 cm	C2 Matte black + C48 Black chrome + Smoke Glass
Glass Ø	16 cm	
Note	Integrated dimmer on cable on request Max dimension bulb (excluded) Ø1,8/H5,7 cm	



552.33 Table

Hardware + Glass

UL CE IP 40

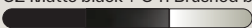
Light source	3 x G9 220/240V	
Wattage (LED)	Max 10W	C2 Matte black + C41 Brushed brass + Clear Glass
Dimensions	Ø30/H55 cm	
Cable	Black fabric Length 150 cm	C2 Matte black + C48 Black chrome + Smoke Glass
Glass Ø	12 cm	
Note	Max dimension bulb (excluded) Ø1,8/H5,7 cm	

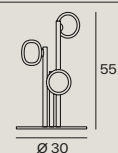





552.33d Integrated dimmer on cable

552.36 Side table

Hardware + Glass

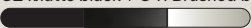

CE  IP 40

Light source	1 x G9 220/240V		
Wattage (LED)	Max 10W	C2 Matte black + C41 Brushed brass + Clear Glass	Ø16
Dimensions	Ø16/H17,5 cm		 17,5
Cable	Black fabric Lenght 150 cm	C2 Matte black + C48 Black chrome + Smoke Glass	
Glass Ø	16 cm		
Note	Integrated dimmer on cable on request Max dimension bulb (excluded) Ø1,8/H5,7 cm		

552.41 Wall/Ceiling

Hardware + Glass

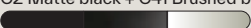

 CE  IP 40

Light source	1 x G9 220/240V		 13	 Ø12
Wattage (LED)	Max 10W	C2 Matte black + C41 Brushed brass + Clear Glass		
Dimmability	According to bulb			
Dimensions	Ø12/D13 cm	C2 Matte black + C48 Black chrome + Smoke Glass		
Glass Ø	12 cm			
Note	Max dimension bulb (excluded) Ø1,8/H5,7 cm			

552.42 Wall/Ceiling

Hardware + Glass

 CE  IP 40

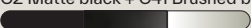
Light source	1 x G9 220/240V		 17	 Ø16
Wattage (LED)	Max 10W	C2 Matte black + C41 Brushed brass + Clear Glass		
Dimmability	According to bulb			
Dimensions	Ø16/D17 cm	C2 Matte black + C48 Black chrome + Smoke Glass		
Glass Ø	16 cm			
Note	Max dimension bulb (excluded) Ø1,8/H5,7 cm			

552.66 Floor

Hardware + Glass

UL CE IP 40

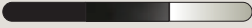
Light source	6 x G9 220/240V	
Wattage (LED)	Max 10W	C2 Matte black + C41 Brushed brass + Clear Glass
Dimensions	Ø33/H140 cm	
Cable	Black fabric Length 300 cm	C2 Matte black + C48 Black chrome + Smoke Glass
Glass Ø	12/16 cm	
Note	Max dimension bulb (excluded) Ø1,8/H5,7 cm	

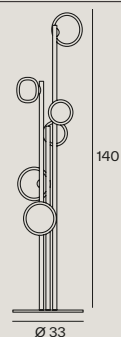

552.66d Integrated dimmer on cable



552.73 Wall/Ceiling

Hardware + Glass

UL CE IP 40

Light source	3 x G9 220/240V	
Wattage (LED)	Max 10W	C2 Matte black + C41 Brushed brass + Clear Glass
Dimmability	According to bulb	
Dimensions	Ø38/H14 cm	C2 Matte black + C48 Black chrome + Smoke Glass
Glass Ø	12 cm	
Note	Max dimension bulb (excluded) Ø1,8/H5,7 cm	



554 Muse
Designed by Corrado Dotti



IT Collezione di lampade dal sapore neo - vintage in metallo con diffusore a doppia parete in vetro borosilicato. Le cupole (una interna e l'altra esterna) in metallo hanno la parte interna di altri colori o finiture. Possono essere verniciate o avere finiture in ottone satinato e rame lucido in modo da avere la possibilità di creare diverse combinazioni materiche. La collezione è composta di lampade a sospensione, piantana, lampada da tavolo e lampade da parete e soffitto. Nelle versioni a sospensione e parete è presente un'ulteriore sorgente G9 posizionata nella parte inferiore della lampada.

ENG Collection of neo-vintage metal lamps with a double-sided diffuser in borosilicate glass. The metal domes (one internal and the other one external) have the internal side with different colors or finishing; they can be painted or finished in polished brass and bright copper, thus to create different textural combinations. The collection presents hanging lamps, floor lamp, table lamp, wall and ceiling. The hanging and wall lamp version are provided with a further G9 source located in the lower part of the lamp.

554.13 Chandelier

Hardware

CE IP 40

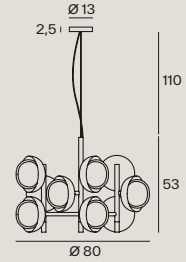

Light source	13 x G9 220/240V	
Wattage (LED)	Max 10W	C74 Sand black + C41 Brushed brass
Dimmability	According to bulb	
Dimensions	Ø80/H53 cm	C74 Sand black + C99 Copper
Cable	Steel Length 125 cm	
Glass Ø	16 cm	
Note	Max dimension bulb (excluded) Ø1,8/H5,7 cm	



554.14 Chandelier

Hardware

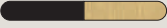
CE IP 40

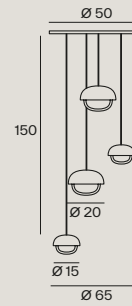

Light source	4 x G9 220/240V	
Wattage (LED)	Max 10W	C74 Sand black + C41 Brushed brass
Dimmability	According to bulb	
Dimensions	Ø65 cm	C74 Sand black + C99 Copper
Cable	Black fabric Length 150 cm	
Glass Ø	12/16 cm	
Note	Max dimension bulb (excluded) Ø1,8/H5,7 cm	



554.21 Pendant

Hardware

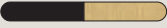
CE IP 40



Light source	1 x G9 220/240V	
Wattage (LED)	Max 10W	C74 Sand black + C41 Brushed brass
Dimmability	According to bulb	
Dimensions	Ø15/H12 cm	C74 Sand black + C99 Copper
Cable	Black fabric Length 150 cm	
Glass Ø	12 cm	
Note	Max dimension bulb (excluded) Ø1,8/H5,7 cm	



554.22 Pendant

Hardware

CE ⊕ IP 40



Light source	1 x G9 220/240V	
Wattage (LED)	Max 10W	C74 Sand black + C41 Brushed brass
Dimmability	According to bulb	
Dimensions	Ø20/H19 cm	C74 Sand black + C99 Copper
Cable	Black fabric Length 150 cm	
Glass Ø	16 cm	
Note	Max dimension bulb (excluded) Ø1,8/H5,7 cm	



554.25 Chandelier

Hardware

CE ⊕ IP 40

Light source	5 x G9 220/240V	
Wattage (LED)	Max 10W	C74 Sand black + C41 Brushed brass
Dimmability	According to bulb	
Dimensions	Ø38/H41 cm	C74 Sand black + C99 Copper
Cable	Steel Length 110 cm	
Glass Ø	16 cm	
Note	Max dimension bulb (excluded) Ø1,8/H5,7 cm	

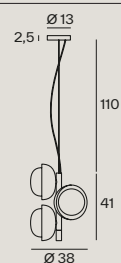

554.35 Table

Hardware

CE ⊕ IP 40

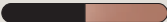
Light source	4 x G9 220/240V	
Wattage (LED)	Max 10W	C74 Sand black + C41 Brushed brass
Dimensions	Ø32/H55 cm	
Cable	Black fabric Length 150 cm	C74 Sand black + C99 Copper
Glass Ø	16 cm	
Note	Max dimension bulb (excluded) Ø1,8/H5,7 cm	

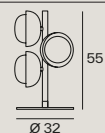



554.35d

Integrated dimmer on cable

554.44 Wall

Hardware

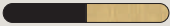
CE  IP 40

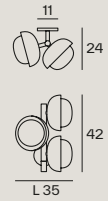

Light source	4 x G9 220/240V	
Wattage (LED)	Max 10W	C74 Sand black + C41 Brushed brass
Dimmability	According to bulb	
Dimensions	L35/H42/D24 cm	C74 Sand black + C99 Copper
Glass Ø	16 cm	
Note	Max dimension bulb (excluded) Ø1,8/H5,7 cm	



554.65 Floor

Hardware

CE  IP 40

Light source	4 x G9 220/240V	
Wattage (LED)	Max 10W	C74 Sand black + C41 Brushed brass
Dimensions	Ø38/H157 cm	
Cable	Black fabric Length 300 cm	C74 Sand black + C99 Copper
Glass Ø	16 cm	
Note	Max dimension bulb (excluded) Ø1,8/H5,7 cm	





554.65d Integrated dimmer on cable

554.71 Wall/Ceiling

Hardware

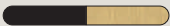
CE  IP 40



Light source	1 x G9 220/240V	
Wattage (LED)	Max 10W	C74 Sand black + C41 Brushed brass
Dimmability	According to bulb	
Dimensions	Ø15/D14 cm	C74 Sand black + C99 Copper
Glass Ø	12 cm	
Note	Max dimension bulb (excluded) Ø1,8/H5,7 cm	



554.72 Wall/Ceiling

Hardware

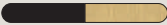
CE  IP 40

Light source	1 x G9 220/240V	
Wattage (LED)	Max 10W	C74 Sand black + C41 Brushed brass
Dimmability	According to bulb	
Dimensions	Ø20/D17 cm	C74 Sand black + C99 Copper
Glass Ø	16 cm	
Note	Max dimension bulb (excluded) Ø1,8/H5,7 cm	



555 Filipa
Designed by Corrado Dotti

IT Lampade ispirate alla classica lanterna cinese. La particolare struttura bidimensionale è in metallo verniciato a polveri epissodiche nella parte esterna, mentre quella interna è di colore grigio sabbia. La collezione è stata arricchita dalla versione in pelle bicolore. La fonte di luce è all'interno di un diffusore a doppia parete in vetro borosilicato e le versioni a sospensione sono dotate di una ulteriore sorgente luminosa LED integrata per un'illuminazione diretta verso il basso.

ENG Collection of lamps inspired by the classic Chinese lanterns. The particular bi-dimensional structure is made by powder coated painted metal on the outside, while the inside color is sand grey. A new version in a twocoloured leather has enriched the collection. The light source is located inside a doubleside borosilicate glass diffuser, while the suspensions have an additional integrated LED light source in order to create a direct illumination downwards.

555.13 Chandelier

Hardware

CE IP 40

Primary light source	3 x G9 220/240V	
Wattage (LED)	Max 10W	C74 Sand black + C46 Sand grey
Dimmability	According to bulb	
Secondary light source	LED 220/240V	C74 Sand black + L01 Two-tone leather
Wattage	4W	
Color temperature	2700K	
Dimmability	Phase cut	
Dimensions	Ø72 cm	
Cable	Black fabric Length 150 cm	
Glass Ø	16 cm	
Note	Max dimension bulb (excluded) Ø1,8/H5,7 cm	

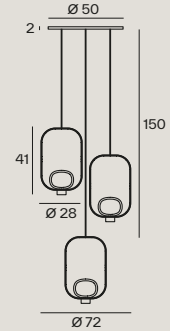

555.22 Pendant

Hardware

CE IP 40

Primary light source	1 x G9 220/240V	
Wattage (LED)	Max 10W	C74 Sand black + C46 Sand grey
Dimmability	According to bulb	
Secondary light source	LED 220/240V	C74 Sand black + L01 Two-tone leather
Wattage	4W	
Color temperature	2700K	
Dimmability	According to bulb	
Dimensions	L28/H45 cm	
Cable	Black fabric Length 150 cm	
Glass Ø	16 cm	
Note	Max dimension bulb (excluded) Ø1,8/H5,7 cm	

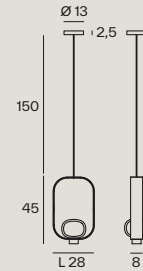

555.31 Table

Hardware

CE IP 40

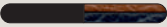
Light source	1 x G9 220/240V	
Wattage (LED)	Max 10W	C74 Sand black + C46 Sand grey
Dimensions	L28/H45 cm	
Cable	Black fabric Length 150 cm	C74 Sand black + L01 Two-tone leather
Glass Ø	16 cm	
Note	Max dimension bulb (excluded) Ø1,8/H5,7 cm	

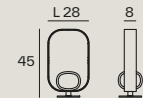

555.31d Integrated dimmer on cable

555.41 Wall

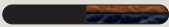
Light source	1 x G9 220/240V	
Wattage (LED)	Max 10W	C74 Sand black + C46 Sand grey
Dimmability	According to bulb	
Dimensions	L28/H49/D18 cm	C74 Sand black + L01 Two-tone leather
Glass Ø	16 cm	
Note	Max dimension bulb (excluded) Ø1,8/H5,7 cm	

CE  IP 40

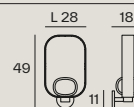

556 Molly
Designed by Corrado Dotti

IT Collezione dallo stile contemporaneo di lampade a sospensione, parete, terra, tavolo, comodino e soffitto dalla cupola e anello in vernice, ottone spazzolato, rame o peltro. Lo schermo luminoso diamantato è in plexiglass per rendere una luce diffusa. La collezione è composta da lampade di tre dimensioni differenti, singole o in combinazioni dinamiche. Dotate di grande versatilità, la semplicità della forma e la ricchezza dei materiali rendono questa collezione adatta a tutti gli ambienti.

ENG Collection of contemporary hanging, wall, floor, table, side and ceiling lamps with a painted dome and ring either painted or finished with brushed brass, copper or pewter. The bright diamond screen is made of plexiglass to better spread light out. The collection presents lamps available in three sizes for single-unit or dynamic compositions. These lamps are very versatile and fit any kind of setting, thanks to their simple shape yet rich materials.

556.14 Chandelier

Light source	LED 220/240V
Wattage	2 x 8W
Color temperature	2700K
Lumens	1600
Light source	LED 220/240V
Wattage	2 x 12W
Color temperature	2700K
Lumens	2400
Dimmability	Phase cut
Dimensions	Ø65 cm
Cable	Black fabric Length 150 cm

Dome

C41 Brushed brass
C46 Sand grey
C50 Pewter
C74 Sand black
C99 Copper

Ring

C41 Brushed brass
C46 Sand grey
C50 Pewter
C74 Sand black
C99 Copper

CE IP 40

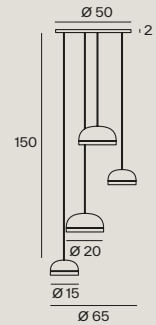

556.21 Pendant

Light source	LED 220/240V
Wattage	8W
Color temperature	2700K
Lumens	800
Dimmability	Phase cut
Dimensions	Ø15/H8,2 cm
Cable	Black fabric Length 150 cm

Dome

C41 Brushed brass
C46 Sand grey
C50 Pewter
C74 Sand black
C99 Copper

Ring

C41 Brushed brass
C46 Sand grey
C50 Pewter
C74 Sand black
C99 Copper

CE IP 40

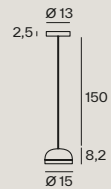

556.22 Pendant

Light source	LED 220/240V
Wattage	12W
Color temperature	2700K
Lumens	1200
Dimmability	Phase cut
Dimensions	Ø20/H10 cm
Cable	Black fabric Length 150 cm

Dome

C41 Brushed brass
C46 Sand grey
C50 Pewter
C74 Sand black
C99 Copper

Ring

C41 Brushed brass
C46 Sand grey
C50 Pewter
C74 Sand black
C99 Copper

CE IP 40



556.23 Pendant

Light source LED 220/240V
 Wattage 17W
 Color temperature 2700K
 Lumens 1500
 Dimmability Phase cut
 Dimensions Ø38/H17 cm
 Cable Black fabric
 Length 150 cm

Dome

C41 Brushed brass
 C46 Sand grey
 C50 Pewter
 C74 Sand black
 C99 Copper

Ring

C41 Brushed brass
 C46 Sand grey
 C50 Pewter
 C74 Sand black
 C99 Copper

CE ⊕ IP 40

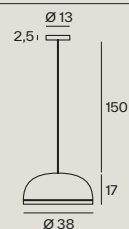

556.26 Chandelier

Light source LED 220/240V
 Wattage 3 x 8W
 Color temperature 2700K
 Lumens 2400
 Light source LED 220/240V
 Wattage 3 x 12W
 Color temperature 2700K
 Lumens 3600
 Dimmability Phase cut
 Dimensions Ø100/200 ~ H50/100 cm
 Cable Black fabric
 Length 150 cm

Dome

C41 Brushed brass
 C46 Sand grey
 C50 Pewter
 C74 Sand black
 C99 Copper

Ring

C41 Brushed brass
 C46 Sand grey
 C50 Pewter
 C74 Sand black
 C99 Copper

CE ⊕ IP 40

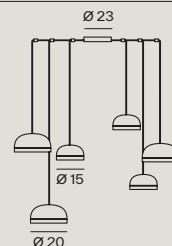

556.31 Side table

Light source LED 220/240V
 Wattage 8W
 Color temperature 2700K
 Lumens 800
 Dimmability Integrated dimmer on cable
 Dimensions Ø17/H28 cm
 Cable Black fabric
 Length 150 cm

Dome

C41 Brushed brass
 C46 Sand grey
 C50 Pewter
 C74 Sand black
 C99 Copper

Ring

C41 Brushed brass
 C46 Sand grey
 C50 Pewter
 C74 Sand black
 C99 Copper



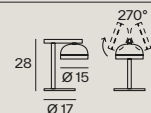

CE □ IP 40



Note

Adjustable direct light 270°

556.32 Table

		Dome	Ring	CE 
Light source	LED 220/240V			
Wattage	12W	C41 Brushed brass	C41 Brushed brass	
Color temperature	2700K			
Lumens	1200	C46 Sand grey	C46 Sand grey	
Dimmability	Integrated dimmer on cable			
Dimensions	Ø25/H47 cm	C50 Pewter	C50 Pewter	
Cable	Black fabric Length 150 cm			
		C74 Sand black	C74 Sand black	
				
		C99 Copper	C99 Copper	
				
Note	Adjustable direct light 270°			

556.42 Wall

		Dome	Ring	CE 
Light source	LED 220/240V			
Wattage	12W	C41 Brushed brass	C41 Brushed brass	
Color temperature	2700K			
Lumens	1200	C46 Sand grey	C46 Sand grey	
Dimmability	Phase cut			
Dimensions	Ø20/H17/D27 cm	C50 Pewter	C50 Pewter	
				
		C74 Sand black	C74 Sand black	
				
		C99 Copper	C99 Copper	
				
Note	Adjustable direct light 270°			

556.62 Floor

		Dome	Ring	CE 
Light source	LED 220/240V			
Wattage	12W	C41 Brushed brass	C41 Brushed brass	
Color temperature	2700K			
Lumens	1200	C46 Sand grey	C46 Sand grey	
Dimmability	Integrated dimmer on cable			
Dimensions	Ø32/H130 cm	C50 Pewter	C50 Pewter	
Cable	Black fabric Length 300 cm			
		C74 Sand black	C74 Sand black	
				
		C99 Copper	C99 Copper	
				
Note	Adjustable direct light 270°			

556.71 Wall/Ceiling

Light source	LED 220/240V
Wattage	8W
Color temperature	2700K
Lumens	800
Dimmability	Phase cut
Dimensions	Ø15/D10 cm

Dome

C41 Brushed brass

C46 Sand grey

C50 Pewter

C74 Sand black

C99 Copper

Ring

C41 Brushed brass

C46 Sand grey

C50 Pewter

C74 Sand black

C99 Copper

CE ⊕ IP 40



556.72 Wall/Ceiling

Light source	LED 220/240V
Wattage	12W
Color temperature	2700K
Lumens	1200
Dimmability	Phase cut
Dimensions	Ø20/D12 cm

Dome

C41 Brushed brass

C46 Sand grey

C50 Pewter

C74 Sand black

C99 Copper

Ring

C41 Brushed brass

C46 Sand grey

C50 Pewter

C74 Sand black

C99 Copper

CE ⊕ IP 40



556.73 Wall/Ceiling

Light source	LED 220/240V
Wattage	17W
Color temperature	2700K
Lumens	1500
Dimmability	Phase cut
Dimensions	Ø38/D19 cm

Dome

C41 Brushed brass

C46 Sand grey

C50 Pewter

C74 Sand black

C99 Copper

Ring

C41 Brushed brass

C46 Sand grey

C50 Pewter

C74 Sand black

C99 Copper

CE ⊕ IP 40

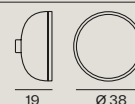

557 Legier
Designed by Corrado Dotti

IT Ispirate alle forme classiche dei profumatori in vetro di Murano, ampole dalle forme sferiche eleganti e fragili d'aspetto ma resistenti e funzionali, utilizzate spesso come elementi decorativi in ogni ambiente della casa. Le lampade possono avere l'attacco in rame, ottone spazzolato o verniciato mentre il diffusore è in vetro soffiato a bocca dalle forme armoniose e decorative di colore fumo o bianco opalino.

Versatili, eleganti e resistenti, possono essere posizionate a terra, su un tavolo, a soffitto a parete e a sospensione, sia in versione singola che nella versione chandelier da quattro o sei elementi. Conferiscono classe e raffinatezza a tutti gli ambienti, dal più sobrio al più sfarzoso.

ENG Collection of lamps inspired by the classical shapes of Murano diffusor usually used as decoration anywhere in a house; elegant spherical cruet apparently fragile yet very robust and functional. These lamps can have the connection in copper, brushed brass or painted, while the diffusor is made by blown glass opal white glass or fumè with harmonious and decorative shapes.

Versatile, elegant and robust, these lamps can be positioned on the floor, on the table, ceiling, wall and hanging, both in one-unit version or in the chandelier one with four or six elements. These lamps give class and sophistication to any location, whether it be sober or lavish.

557.14 Chandelier

Hardware + Ring + Glass

CE IP 40

Light source LED 220/240V
Wattage 4 x 10W
Color temperature 2700K
Lumens 4800
Dimmability Phase cut
Dimensions Ø80 cm
Cable Black fabric
Length 150 cm

C74 Sand black + C30 Light grey + Smoke Glass
C74 Sand black + C41 Brushed brass + Smoke Glass
C74 Sand black + C99 Copper + Smoke Glass
C74 Sand black + C30 Light grey + Opal white glass
C74 Sand black + C41 Brushed brass + Opal white glass
C74 Sand black + C99 Copper + Opal white glass

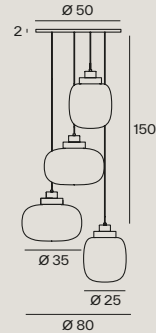

Note Also available in E27 with opal white glass only

557.22 Pendant

Hardware + Ring + Glass

CE IP 40

Light source LED 220/240V
Wattage 10W
Color temperature 2700K
Lumens 1200
Dimmability Phase cut
Dimensions Ø25/H33 cm
Cable Black fabric
Length 150 cm

C74 Sand black + C30 Light grey + Smoke Glass
C74 Sand black + C41 Brushed brass + Smoke Glass
C74 Sand black + C99 Copper + Smoke Glass
C74 Sand black + C30 Light grey + Opal white glass
C74 Sand black + C41 Brushed brass + Opal white glass
C74 Sand black + C99 Copper + Opal white glass

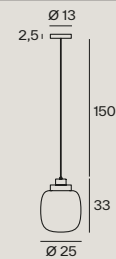

Note Also available in E27 with opal white glass only

557.24 Pendant

Hardware + Ring + Glass

CE IP 40

Light source LED 220/240V
Wattage 10W
Color temperature 2700K
Lumens 1200
Dimmability Phase cut
Dimensions Ø35/H28 cm
Cable Black fabric
Length 150 cm

C74 Sand black + C30 Light grey + Smoke Glass
C74 Sand black + C41 Brushed brass + Smoke Glass
C74 Sand black + C99 Copper + Smoke Glass
C74 Sand black + C30 Light grey + Opal white glass
C74 Sand black + C41 Brushed brass + Opal white glass
C74 Sand black + C99 Copper + Opal white glass

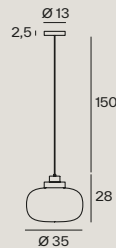

Note Also available in E27 with opal white glass only

557.26 Chandelier

Hardware + Ring + Glass

CE  IP40

Light source	LED 220/240V	
Wattage	6 x 10W	C74 Sand black + C30 Light grey + Smoke Glass
Color temperature	2700K	
Lumens	7200	C74 Sand black + C41 Brushed brass + Smoke Glass
Dimmability	Phase cut	
Dimensions	Ø 100/200 ~ H50/100 cm	C74 Sand black + C99 Copper + Smoke Glass
Cable	Black fabric Length 150 cm	
		
		
		

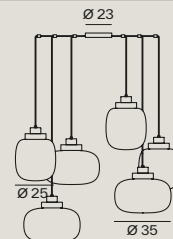

Note Also available in E27 with opal white glass only

557.32 Table

Hardware + Ring + Glass

CE  IP40

Light source	LED 220/240V	
Wattage	8W	C74 Sand black + C30 Light grey + Smoke Glass
Color temperature	2700K	
Lumens	800	C74 Sand black + C41 Brushed brass + Smoke Glass
Dimmability	Integrated dimmer on cable	
Dimensions	Ø25/H30 cm	C74 Sand black + C99 Copper + Smoke Glass
		
Cable	Black fabric Length 150 cm	
		
		
		



Note Also available in E27 with opal white glass only

557.34 Table

Hardware + Ring + Glass

CE  IP40

Light source	LED 220/240V	
Wattage	8W	C74 Sand black + C30 Light grey + Smoke Glass
Color temperature	2700K	
Lumens	800	C74 Sand black + C41 Brushed brass + Smoke Glass
Dimmability	Integrated dimmer on cable	
Dimensions	Ø35/H26 cm	C74 Sand black + C99 Copper + Smoke Glass
		
Cable	Black fabric Length 150 cm	
		
		
		

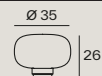



Note Also available in E27 with opal white glass only

557.42 Wall

Light source LED 220/240V
Wattage 10W
Color temperature 2700K
Lumens 1200
Dimmability Phase cut
Dimensions Ø25/H38/D28 cm

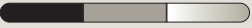
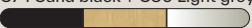
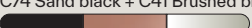
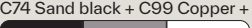
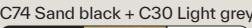
Hardware + Ring + Glass

 C74 Sand black + C30 Light grey + Smoke Glass
 C74 Sand black + C41 Brushed brass + Smoke Glass
 C74 Sand black + C99 Copper + Smoke Glass
 C74 Sand black + C30 Light grey + Opal white glass
 C74 Sand black + C41 Brushed brass + Opal white glass
 C74 Sand black + C99 Copper + Opal white glass

CE  IP 40

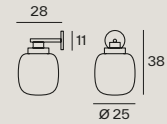



Note Also available in E27 with opal white glass only

557.44 Wall

Light source LED 220/240V
Wattage 10W
Color temperature 2700K
Lumens 1200
Dimmability Phase cut
Dimensions Ø35/H35/D38 cm

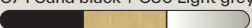
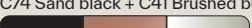
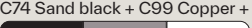
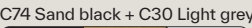
Hardware + Ring + Glass

 C74 Sand black + C30 Light grey + Smoke Glass
 C74 Sand black + C41 Brushed brass + Smoke Glass
 C74 Sand black + C99 Copper + Smoke Glass
 C74 Sand black + C30 Light grey + Opal white glass
 C74 Sand black + C41 Brushed brass + Opal white glass
 C74 Sand black + C99 Copper + Opal white glass

CE  IP 40

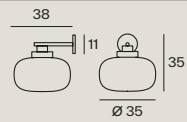



Note Also available in E27 with opal white glass only

557.72 Ceiling

Light source LED 220/240V
Wattage 10W
Color temperature 2700K
Lumens 1200
Dimmability Phase cut
Dimensions Ø25/H30 cm

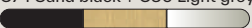
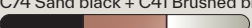
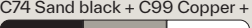
Hardware + Ring + Glass

 C74 Sand black + C30 Light grey + Smoke Glass
 C74 Sand black + C41 Brushed brass + Smoke Glass
 C74 Sand black + C99 Copper + Smoke Glass
 C74 Sand black + C30 Light grey + Opal white glass
 C74 Sand black + C41 Brushed brass + Opal white glass
 C74 Sand black + C99 Copper + Opal white glass

CE  IP 40



Note Also available in E27 with opal white glass only

557.74 Ceiling

Hardware + Ring + Glass

CE  IP 40

Light source	LED 220/240V
Wattage	10W
Color temperature	2700K
Lumens	1200
Dimmability	Phase cut
Dimensions	Ø35/H26 cm

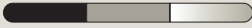
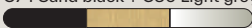
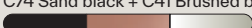
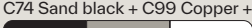
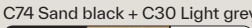
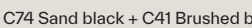
	C74 Sand black + C30 Light grey + Smoke Glass
	C74 Sand black + C41 Brushed brass + Smoke Glass
	C74 Sand black + C99 Copper + Smoke Glass
	C74 Sand black + C30 Light grey + Opal white glass
	C74 Sand black + C41 Brushed brass + Opal white glass
	C74 Sand black + C99 Copper + Opal white glass

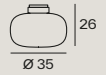

Note Also available in E27 with opal white glass only

558 Lilly
Designed by Corrado Dotti

IT Dall'allure orientale, riprendono la leggerezza, la sobrietà e il minimalismo tipico del design asiatico. Le lampade sono con struttura in metallo verniciato a polveri epossidiche e diffusore in tessuto e rete. Versatile ed elegante, la collezione presenta sospensioni di tre misure differenti, la versione da parete, da tavolo e piantana.
Conferiscono agli ambienti un'eleganza non ostentata, ma celata nella raffinatezza del design e dei materiali che la caratterizzano.

ENG Collection of lamps characterized by an oriental taste, reinterpreting the lightness, sobriety and minimalism of Asian design. These lamps have a metal structure painted with epoxy powder and a coated with mesh diffusor. Versatile and elegant, this collection presents different versions: hanging lamps in three different sizes, a wall lamp, table lamp and floor lamp.
These objects give any environment a kind of simple elegance through the sophisticated design and materials.

558.22 Pendant

Light source 1 x E27 220/240V
Wattage (LED) Max 15W
Dimmability According to bulb
Dimensions Ø22/H15 cm
Cable Black fabric
Length 150 cm

Hardware + Fabric

 C74 Sand black + Beige Fabric and black net

CE  IP 20

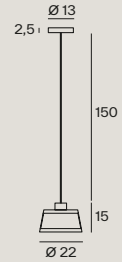

558.23 Pendant

Light source 1 x E27 220/240V
Wattage (LED) Max 15W
Dimmability According to bulb
Dimensions Ø32/H21 cm
Cable Black fabric
Length 150 cm

Hardware + Fabric

 C74 Sand black + Beige Fabric and black net

CE  IP 20



558.25 Pendant

Light source 1 x E27 220/240V
Wattage (LED) Max 15W
Dimmability According to bulb
Dimensions Ø50/H25 cm
Cable Black fabric
Length 150 cm

Hardware + Fabric

 C74 Sand black + Beige Fabric and black net

CE  IP 20

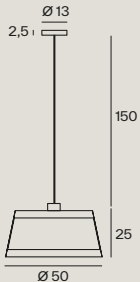

558.31 Side table

Hardware + Fabric

CE  IP20

Light source	1 x E14 220/240V	
Wattage (LED)	Max 10W	C74 Sand black + Beige Fabric and black net
Dimensions	Ø22/H28 cm	
Cable	Black fabric Length 150 cm	
Note	Integrated dimmer on cable on request	



558.32 Table

Hardware + Fabric

CE  IP20

Light source	1 x E27 220/240V	
Wattage (LED)	Max 15W	C74 Sand black + Beige Fabric and black net
Dimensions	Ø50/H60 cm	
Cable	Black fabric Length 150 cm	

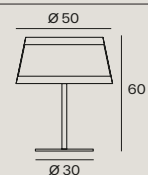

558.32d Integrated dimmer on cable

558.42 Wall

Hardware + Fabric

CE  IP20

Light source	1 x E27 220/240V	
Wattage (LED)	Max 15W	C74 Sand black + Beige Fabric and black net
Dimmability	According to bulb	
Dimensions	Ø22/H22/D30 cm	

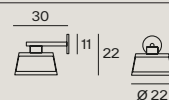

558.65 Floor

Hardware + Fabric

CE  IP 20

Light source 1 x E27 220/240V

Wattage Max 15W

Dimensions Ø50/H150 cm

Cable Black fabric
Length 300 cm

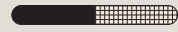

C74 Sand black + Beige Fabric and black net

558.65d Integrated dimmer on cable

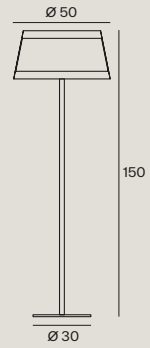

559 Excalibur
Designed by Corrado Dotti

IT Lampada dalla leggera ispirazione Decò, composta da un corpo in metallo nero con 2 diffusori prismatici in plexiglass, contornato da 3 lamine rettangolari in ottone satinato. Elegante e versatile disponibile nelle seguenti versioni: sospensione singola o a grappolo, chandelier di due dimensioni, lampada da parete singola o doppia.

ENG A slightly Deco inspired lamp. The main body is in black coating and the light is spread through 2 plexiglass prisms and it's wrapped into 3 rectangular brushed brass foils. It is available in different compositions: single or bunch suspension, chandeliers in two different dimension, single or double wall lamp.

559.12 Chandelier

Hardware

CE Ⓢ IP 40

Light source	LED 220/240V
Wattage	12 x 10W
Color temperature	2700K
Lumens	14400
Dimmability	Phase cut
Dimensions	Ø107/H107 cm
Cable	Steel Length 125 cm

 C74 Sand black + C41 Brushed brass

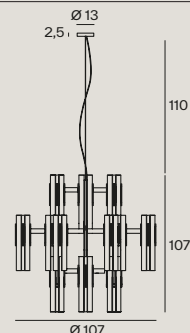

559.13 Chandelier

Hardware

CE Ⓢ IP 40

Light source	LED 220/240V
Wattage	3 x 10W
Color temperature	2700K
Lumens	3600
Dimmability	Phase cut
Dimensions	Ø50/H45 cm
Cable	Black fabric Length 150 cm

 C74 Sand black + C41 Brushed brass

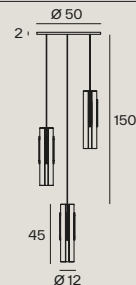

559.21 Pendant

Hardware

CE Ⓢ IP 40

Light source	LED 220/240V
Wattage	10W
Color temperature	2700K
Lumens	1200
Dimmability	Phase cut
Dimensions	Ø12/H45 cm
Cable	Black fabric Length 150 cm

 C74 Sand black + C41 Brushed brass

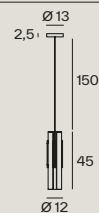

559.23 Chandelier

Hardware

CE IP 40

Light source	LED 220/240V	
Wattage	3 x 10W	C74 Sand black + C41 Brushed brass
Color temperature	2700K	
Lumens	3600	
Dimmability	Phase cut	
Dimensions	Ø38/H45 cm	
Cable	Steel Length 125 cm	

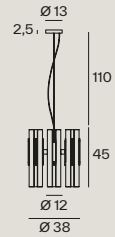

559.26 Chandelier

Hardware

CE IP 40

Light source	LED 220/240V	
Wattage	6 x 10W	C74 Sand black + C41 Brushed brass
Color temperature	2700K	
Lumens	7200	
Dimmability	Phase cut	
Dimensions	Ø100/200 ~ H50/100 cm	
Cable	Black fabric Length 150 cm	

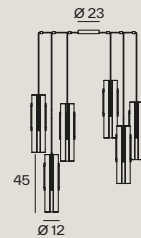

559.41 Wall

Hardware

CE IP 40

Light source	LED 220/240V	
Wattage	10W	C74 Sand black + C41 Brushed brass
Color temperature	2700K	
Lumens	1200	
Dimmability	Phase cut	
Dimensions	Ø12/H45/D15 cm	

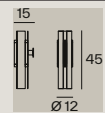

559.42 Wall

Hardware

CE  IP 40

Light source	LED 220/240V
Wattage	2 x 10W
Color temperature	2700K
Lumens	2400
Dimmability	Phase cut
Dimensions	Ø32/H45/D15 cm

C74 Sand black + C41 Brushed brass

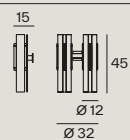

560 Osman
Designed by Corrado Dotti

IT Famiglia di lampade dal design razionale arricchita dai preziosi dettagli metallici e dai diffusori cilindrici a doppia parete che donano una diffusione luminosa affascinante e armonica. La particolare struttura ortogonale e le proporzioni ben equilibrate danno a queste lampade un forte segno avanguardistico pur mantenendo un aspetto formale familiare e raffinato.

ENG Family of lamps with a rational design enriched by precious metallic details and double-wall cylindrical diffusers that give a fascinating and harmonious light diffusion. The particular orthogonal structure and the well-balanced proportions give these lamps a strong avantgarde sign while maintaining a formal, familiar and refined appearance.

560.12 Chandelier

Hardware + Glass

CE  IP 20

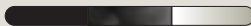

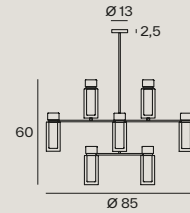
Light source	12 x E14 220/240V	
Wattage (LED)	Max 10W	C2 Matte black + C41 Brushed brass + Clear Glass
Dimmability	According to bulb	
Dimensions	Ø85/H60 cm	C2 Matte black + C48 Black chrome + Smoke Glass
Stem kit (Adjusted on site)	1 x 60/1 x 90 cm	
Note	Custom stem on request (Min 35 cm) Max dimension bulb (excluded) Ø3 cm	



560.16 Chandelier

Hardware + Glass

CE  IP 20

Light source	16 x E14 220/240V	
Wattage (LED)	Max 10W	C2 Matte black + C41 Brushed brass + Clear Glass
Dimmability	According to bulb	
Dimensions	Ø95/H60 cm	C2 Matte black + C48 Black chrome + Smoke Glass
Stem kit (Adjusted on site)	1 x 60/1 x 90 cm	
Note	Custom stem on request (Min 35 cm) Max dimension bulb (excluded) Ø3 cm	

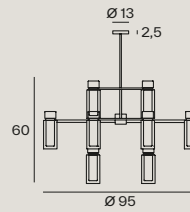

560.17 Chandelier

Hardware + Glass

CE  IP 20

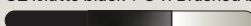

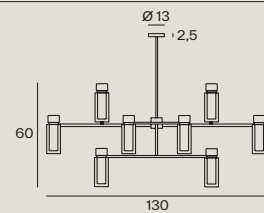
Light source	16 x E14 220/240V	
Wattage (LED)	Max 10W	C2 Matte black + C41 Brushed brass + Clear Glass
Dimmability	According to bulb	
Dimensions	Ø130/H60 cm	C2 Matte black + C48 Black chrome + Smoke Glass
Stem kit (Adjusted on site)	1 x 60/1 x 90 cm	
Note	Custom stem on request (Min 35 cm) Max dimension bulb (excluded) Ø3 cm	



560.21 Pendant

Hardware + Glass

CE  IP 20



Light source	1 x E14 220/240V	
Wattage (LED)	Max 10W	C2 Matte black + C41 Brushed brass + Clear Glass
Dimmability	According to bulb	
Dimensions	Ø8/H23 cm	C2 Matte black + C48 Black chrome + Smoke Glass
Cable	Black fabric Length 150 cm	
Note	Max dimension bulb (excluded) Ø3 cm	



560.31 Side table

Hardware + Glass

CE  IP 20

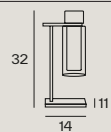

Light source	1 x E14 220/240V	
Wattage (LED)	Max 10W	C2 Matte black + C41 Brushed brass + Clear Glass
Dimensions	L14/H32 cm	
Cable	Black fabric Length 150 cm	C2 Matte black + C48 Black chrome + Smoke Glass
Note	Integrated dimmer on cable on request Max dimension bulb (excluded) Ø3 cm	



560.34 Table

Hardware + Glass

CE  IP 20

Light source	4 x E14 220/240V	
Wattage (LED)	Max 10W	C2 Matte black + C41 Brushed brass + Clear Glass
Dimensions	Ø35/H55 cm	
Cable	Black fabric Length 150 cm	C2 Matte black + C48 Black chrome + Smoke Glass
Note	Max dimension bulb (excluded) Ø3 cm	

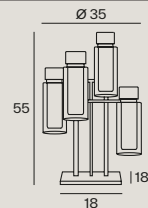

560.34d Integrated dimmer on cable

560.41 Wall

Hardware + Glass

CE  IP 20

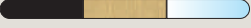
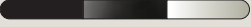

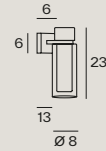
Light source	1 x E14 220/240V	
Wattage (LED)	Max 10W	C2 Matte black + C41 Brushed brass + Clear Glass
Dimmability	According to bulb	
Dimensions	Ø8/H23/D13 cm	C2 Matte black + C48 Black chrome + Smoke Glass
Note	Max dimension bulb (excluded) Ø3 cm	



560.42 Wall

Hardware + Glass

CE  IP 20

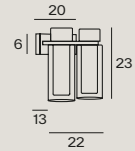

Light source	2 x E14 220/240V	
Wattage (LED)	Max 10W	C2 Matte black + C41 Brushed brass + Clear Glass
Dimmability	According to bulb	
Dimensions	L22/H23/D13 cm	C2 Matte black + C48 Black chrome + Smoke Glass
Note	Max dimension bulb (excluded) Ø3 cm	



560.45 Wall recessed

Hardware + Glass

CE  IP 20

Light source	1 x E14 220/240V	
Wattage (LED)	Max 10W	C2 Matte black + C41 Brushed brass + Clear Glass
Dimmability	According to bulb	
Dimensions	Ø8/H23/D11 cm	C2 Matte black + C48 Black chrome + Smoke Glass
Note	Max dimension bulb (excluded) Ø3 cm	

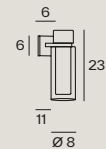

560.46 Wall recessed

Hardware + Glass

CE ⊕ IP 20

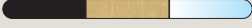
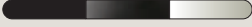
Light source	2 x E14 220/240V	
Wattage (LED)	Max 10W	C2 Matte black + C41 Brushed brass + Clear Glass
Dimmability	According to bulb	
Dimensions	L22/H23/D11 cm	C2 Matte black + C48 Black chrome + Smoke Glass
Note	Max dimension bulb (excluded) Ø3 cm	

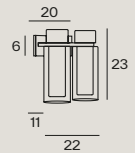

560.61 Floor

Hardware + Glass

CE □ IP 20

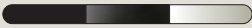

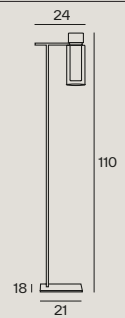
Light source	1 x E14 220/240V	
Wattage (LED)	Max 10W	C2 Matte black + C41 Brushed brass + Clear Glass
Dimensions	L24/H110 cm	
Cable	Black fabric Length 300 cm	C2 Matte black + C48 Black chrome + Smoke Glass
Note	Integrated dimmer on cable on request Max dimension bulb (excluded) Ø3 cm	



560.64 Floor

Hardware + Glass

CE ⊕ IP 20

Light source	4 x E14 220/240V	
Wattage (LED)	Max 10W	C2 Matte black + C41 Brushed brass + Clear Glass
Dimensions	Ø35/H140 cm	
Cable	Black fabric Length 300 cm	C2 Matte black + C48 Black chrome + Smoke Glass
Note	Max dimension bulb (excluded) Ø3 cm	

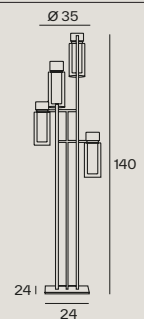



560.64d Integrated dimmer on cable

560.74 Wall/Ceiling

Hardware + Glass

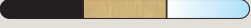
CE  IP 20

Light source	4 x E14 220/240V	
Wattage (LED)	Max 10W	C2 Matte black + C41 Brushed brass + Clear Glass
Dimmability	According to bulb	
Dimensions	L54/H54/D13 cm	C2 Matte black + C48 Black chrome + Smoke Glass
Note	Max dimension bulb (excluded) Ø3 cm	

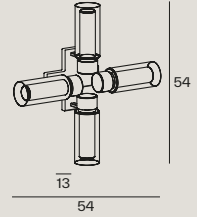

561 Gordon
Designed by Corrado Dotti



IT Una nuova interpretazione formale e materica del diffusore conico è la caratteristica principale delle lampade GORDON. Dall'aspetto essenziale e raffinato ma dal carattere forte conferitogli dalla forma della fusione in ottone, queste lampade pratiche e versatili si prestano ad essere usate in diversi ambienti, da quello domestico a quello lavorativo come negli spazi commerciali e 'hospitality'.

ENG A new formal and material interpretation of the conical diffuser is the main feature of GORDON lamps. The essential and refined aspect with a strong character that is conferred by the shape of the brass casting; these practical and versatile lamps are suitable to be used in different environments, from the domestic to the working one as in the commercial spaces and 'hospitality'.

561.11a Ceiling

Hardware

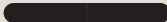
CE IP 40

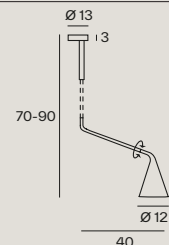

Light source	1 x E27 220/240V	
Wattage (LED)	Max 10W	C2 Matte black + C2 Matte black
Dimmability	According to bulb	
Dimensions	L40/H70-90 cm	C2 Matte black + C41 Brushed brass
Stem	70 to 90 cm	
Adjusted on site		C2 Matte black + C48 Black chrome
Note	Adjustable direct light 270°	



561.11b Ceiling

Hardware

CE IP 40

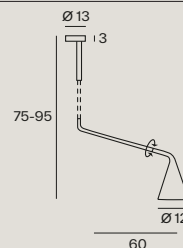

Light source	1 x E27 220/240V	
Wattage (LED)	Max 10W	C2 Matte black + C2 Matte black
Dimmability	According to bulb	
Dimensions	L60/H75-95 cm	C2 Matte black + C41 Brushed brass
Stem	75 to 95 cm	
Adjusted on site		C2 Matte black + C48 Black chrome
Note	Adjustable direct light 270°	



561.11c Ceiling

Hardware

CE IP 40

Light source	1 x E27 220/240V	
Wattage (LED)	Max 10W	C2 Matte black + C2 Matte black
Dimmability	According to bulb	
Dimensions	L80/H80-100 cm	C2 Matte black + C41 Brushed brass
Stem	80 to 100 cm	
Adjusted on site		C2 Matte black + C48 Black chrome
Note	Adjustable direct light 270°	

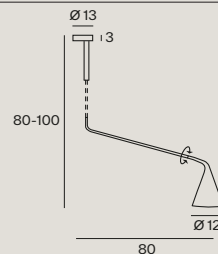



561.13abc Chandelier

Light source	3 x E27 220/240V	
Wattage (LED)	Max 10W	C2 Matte black + C2 Matte black
Dimmability	According to bulb	
Dimensions	L120/H80-100 cm	C2 Matte black + C41 Brushed brass
Stem	80 to 100 cm	
Adjusted on site		C2 Matte black + C48 Black chrome
Note	Adjustable direct light 270°	

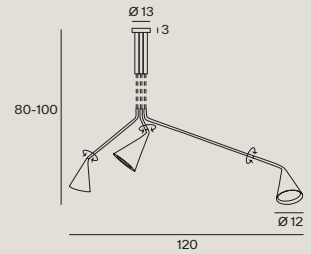
CE  IP 40



561.15a Ceiling recessed

Light source	1 x E27 220/240V	
Wattage (LED)	Max 10W	C2 Matte black + C2 Matte black
Dimmability	According to bulb	
Dimensions	L40/H70-90 cm	C2 Matte black + C41 Brushed brass
Stem	70 to 90 cm	
Adjusted on site		C2 Matte black + C48 Black chrome
Note	Adjustable direct light 270°	

CE  IP 40

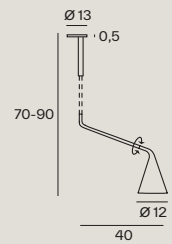

561.15b Ceiling recessed

Light source	1 x E27 220/240V	
Wattage (LED)	Max 10W	C2 Matte black + C2 Matte black
Dimmability	According to bulb	
Dimensions	L60/H75-95 cm	C2 Matte black + C41 Brushed brass
Stem	5 to 95 cm	
Adjusted on site		C2 Matte black + C48 Black chrome
Note	Adjustable direct light 270°	

CE  IP 40

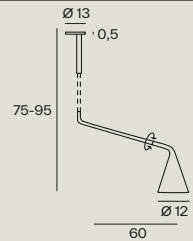

561.15c Ceiling recessed

Hardware

CE ⊕ IP 40

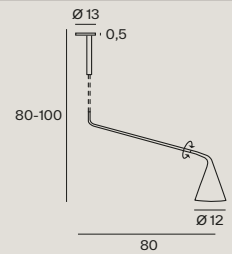

Light source	1 x E27 220/240V	
Wattage (LED)	Max 10W	C2 Matte black + C2 Matte black
Dimmability	According to bulb	
Dimensions	L80/H80-100 cm	C2 Matte black + C41 Brushed brass
Stem	80 to 100 cm	
Adjusted on site		C2 Matte black + C48 Black chrome
Note	Adjustable direct light 270°	



561.15abc Chandelier recessed

Hardware

CE ⊕ IP 40

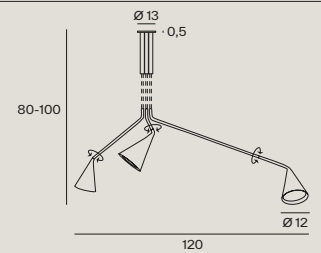

Light source	3 x E27 220/240V	
Wattage (LED)	Max 10W	C2 Matte black + C2 Matte black
Dimmability	According to bulb	
Dimensions	L120/H80-100 cm	C2 Matte black + C41 Brushed brass
Stem	80 to 100 cm	
Adjusted on site		C2 Matte black + C48 Black chrome
Note	Adjustable direct light 270°	



561.21 Pendant

Hardware

CE ⊕ IP 40

Light source	1 x E27 220/240V	
Wattage (LED)	Max 10W	C2 Matte black + C2 Matte black
Dimmability	According to bulb	
Dimensions	Ø12/H23 cm	C2 Matte black + C41 Brushed brass
Cable	Black fabric Length 150 cm	
		C2 Matte black + C48 Black chrome

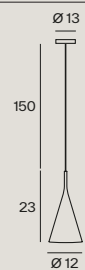

561.22 Pendant

Light source 1 x E27 220/240V
Wattage (LED) Max 10W
Dimmability According to bulb
Dimensions Ø18/H35 cm
Cable Black fabric
Length 150 cm

Hardware

C2 Matte black + C2 Matte black
C2 Matte black + C41 Brushed brass
C2 Matte black + C48 Black chrome

CE  IP 40

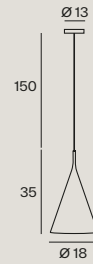

561.24 Pendant

Light source LED 220/240V
Wattage 20W
Color temperature 3000K
Lumens 2500
Dimensions Ø44/H18 cm
Cable Black fabric
Length 150 cm

Hardware

C2 Matte black + C2 Matte black
C2 Matte black + C41 Brushed brass
C2 Matte black + C48 Black chrome

CE  IP 40

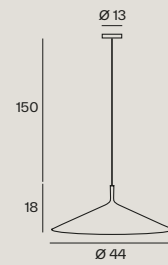

561.31 Table

Light source 1 x E27 220/240V
Wattage (LED) Max 10W
Dimensions L30/H45 cm
Cable Black fabric
Length 150 cm

Hardware

C2 Matte black + C2 Matte black
C2 Matte black + C41 Brushed brass
C2 Matte black + C48 Black chrome

CE  IP 40

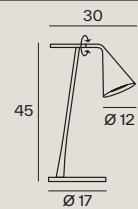

Note Integrated dimmer on cable on request
Adjustable direct light 270°

561.41 Wall

Light source 1 x E27 220/240V
Wattage (LED) Max 10W
Dimmability According to bulb
Dimensions Ø12/H22/D23 cm

Hardware

● C2 Matte black + C2 Matte black
● C2 Matte black + C41 Brushed brass
● C2 Matte black + C48 Black chrome

CE ⊕ IP 40

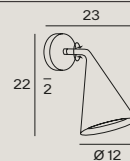

Note Adjustable direct light 270°

561.42 Wall

Light source 1 x E27 220/240V
Wattage (LED) Max 10W
Dimmability According to bulb
Dimensions Ø12/H22/D29 cm

Hardware

● C2 Matte black + C2 Matte black
● C2 Matte black + C41 Brushed brass
● C2 Matte black + C48 Black chrome

CE ⊕ IP 40

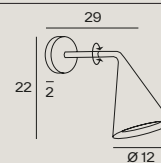

Note Adjustable direct light 270°

561.43 Wall

Light source 1 x E27 220/240V
Wattage (LED) Max 10W
Dimmability According to bulb
Dimensions Ø12/H22/D35 cm

Hardware

● C2 Matte black + C2 Matte black
● C2 Matte black + C41 Brushed brass
● C2 Matte black + C48 Black chrome

CE ⊕ IP 40

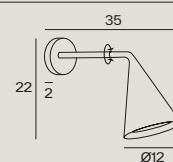

Note Adjustable direct light 270°

561.45 Wall Recessed

Hardware

CE  IP 40

Light source	1 x E27 220/240V	
Wattage (LED)	Max 10W	C2 Matte black + C2 Matte black
Dimmability	According to bulb	
Dimensions	Ø12/H22/D21 cm	C2 Matte black + C41 Brushed brass  C2 Matte black + C48 Black chrome

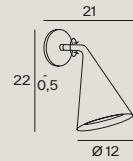

Note Adjustable direct light 270°

561.46 Wall Recessed

Hardware

CE  IP 40

Light source	1 x E27 220/240V	
Wattage (LED)	Max 10W	C2 Matte black + C2 Matte black
Dimmability	According to bulb	
Dimensions	Ø12/H22/D27 cm	C2 Matte black + C41 Brushed brass  C2 Matte black + C48 Black chrome

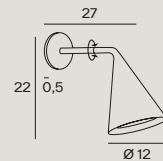

Note Adjustable direct light 270°

561.47 Wall Recessed

Hardware

CE  IP 40

Light source	1 x E27 220/240V	
Wattage (LED)	Max 10W	C2 Matte black + C2 Matte black
Dimmability	According to bulb	
Dimensions	Ø12/H22/D32 cm	C2 Matte black + C41 Brushed brass  C2 Matte black + C48 Black chrome

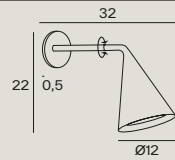

Note Adjustable direct light 270°

561.48 Wall



Light source	2 x E27 220/240V	
Wattage (LED)	Max 10W	C2 Matte black + C2 Matte black
Dimmability	According to bulb	
Dimensions	Ø12/H40/D58-85 cm	C2 Matte black + C41 Brushed brass  C2 Matte black + C48 Black chrome

Note Adjustable direct light 270°
External cable plug on request
Cable length 200 cm

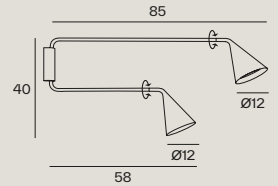
CE ⊕ IP 40

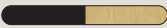

561.49 Wall



Light source	1 x E27 220/240V	
Wattage (LED)	Max 10W	C2 Matte black + C2 Matte black
Dimmability	According to bulb	
Dimensions	Ø12/D160 cm	C2 Matte black + C41 Brushed brass  C2 Matte black + C48 Black chrome

Note Adjustable direct light 270°
External cable plug on request
Cable length 200 cm

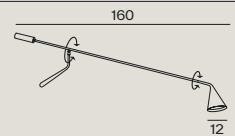
CE ⊕ IP 40

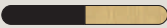

561.61 Floor

Light source	1 x E27 220/240V	
Wattage (LED)	Max 10W	C2 Matte black + C2 Matte black
Dimensions	L30/H140 cm	
Cable	Black fabric Length 300 cm	C2 Matte black + C41 Brushed brass  C2 Matte black + C48 Black chrome

Note Integrated dimmer on cable on request
Adjustable direct light 270°

CE □ IP 40

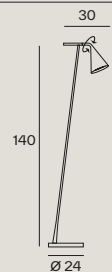

561.71 Ceiling

Hardware

CE  IP 40

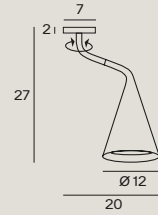

Light source	1 x E27 220/240V	
Wattage (LED)	Max 10W	C2 Matte black + C2 Matte black
Dimmability	According to bulb	
Dimensions	L20/H27 cm	C2 Matte black + C41 Brushed brass
		 C2 Matte black + C48 Black chrome
Note	Adjustable direct light 270°	



561.75 Ceiling recessed

Hardware

CE  IP 40

Light source	1 x E27 220/240V	
Wattage (LED)	Max 10W	C2 Matte black + C2 Matte black
Dimmability	According to bulb	
Dimensions	L20/H25 cm	C2 Matte black + C41 Brushed brass
		 C2 Matte black + C48 Black chrome
Note	Adjustable direct light 270°	

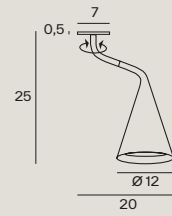

562 Thula
Designed by Federica Biasi

IT Disegnate da Federica Biasi, le appliques e le lampade a sospensione Thula sono fondate su un elemento centrale semplice e architettonico con funzione illuminante a cui si aggiunge, in un sapiente gioco di addizione e sottrazione, una componente organica in legno o in pelle trapuntata. La fonte luminosa consiste in un LED lineare dimmerabile; nella versione base a parete può essere orientata, dando quindi luce diretta o indiretta.

ENG Designed by Federica Biasi, the Thula appliques and suspension lamps are based on a simple and architectural central element with an illuminating function to which an organic component in wood or quilted leather is added in a skillful game of addition and subtraction. Consists of a linear dimmable LED; in the simple wall version it can be oriented, thus giving direct or indirect light.

562.21 Pendant

Light source	220/240V LED
Wattage	11W
Color temperature	2700k
Lumens	1500
Dimmability	TRIAC, Dali version on request
Dimensions	L67/H11/W25 cm
Cable	Black Length 150 cm

Hardware

	C22 Beige + C22 Beige
	C22 Beige + C68 Satin nickel
	C74 Sand black + C74 Sand black
	C74 Sand black + C68 Satin nickel

Shade

	L02 Beige leather
	W02 Walnut
	W03 White oak

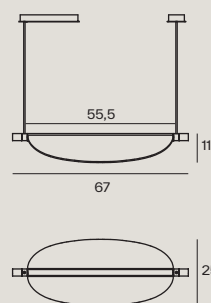

562.22 Pendant

Light source	220/240V LED
Wattage	20W
Color temperature	2700k
Lumens	2600
Dimmability	TRIAC, Dali version on request
Dimensions	L104/H11/W25 cm
Cable	Black Length 150 cm

Hardware

	C22 Beige + C22 Beige
	C22 Beige + C68 Satin nickel
	C74 Sand black + C74 Sand black
	C74 Sand black + C68 Satin nickel

Shade

	L02 Beige leather
	W02 Walnut
	W03 White oak

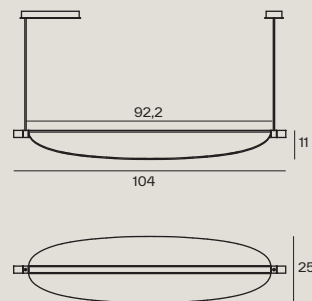

562.23 Pendant

Light source	220/240V LED
Wattage	26W
Color temperature	2700k
Lumens	3400
Dimmability	TRIAC, DALI version on request
Dimensions	L134/H11/W25 cm
Cable	Black Length 150 cm

Hardware

	C22 Beige + C22 Beige
	C22 Beige + C68 Satin nickel
	C74 Sand black + C74 Sand black
	C74 Sand black + C68 Satin nickel

Shade

	L02 Beige leather
	W02 Walnut
	W03 White oak

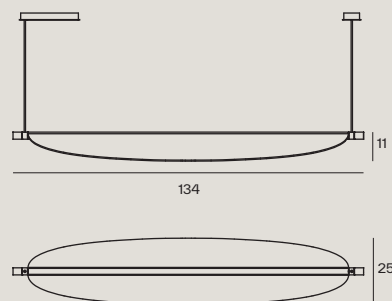

562.41 Wall / Ceiling

Light source 24V
Wattage 11W
Color temperature 2700k
Lumens 1400
Dimmability TRIAC, Dali version on request
Dimensions H67/W25/D13 cm
Note Available with cable and plug

Hardware

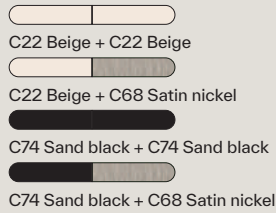
C22 Beige + C22 Beige
C22 Beige + C68 Satin nickel
C74 Sand black + C74 Sand black
C74 Sand black + C68 Satin nickel

Shade

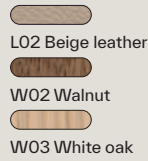
L02 Beige leather
W02 Walnut
W03 White oak

CE  IP 40

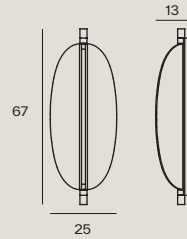

562.42 Wall / Ceiling

Light source 24V
Wattage 20W
Color temperature 2700k
Lumens 2600
Dimmability TRIAC, Dali version on request
Dimensions H104/W25/D13 cm
Note Available with cable and plug

Hardware

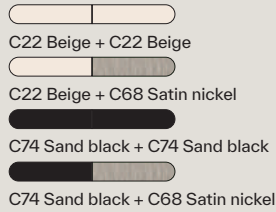
C22 Beige + C22 Beige
C22 Beige + C68 Satin nickel
C74 Sand black + C74 Sand black
C74 Sand black + C68 Satin nickel

Shade

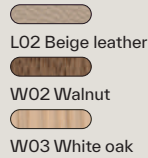
L02 Beige leather
W02 Walnut
W03 White oak

CE  IP 40

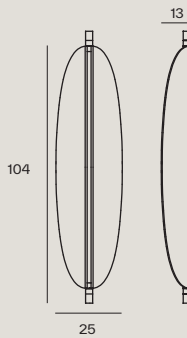

562.43 Wall / Ceiling

Light source 24V
Wattage 26W
Color temperature 2700k
Lumens 3400
Dimmability TRIAC, DALI version on request
Dimensions H134/W25/D13 cm
Note Available with cable and plug

Hardware

C22 Beige + C22 Beige
C22 Beige + C68 Satin nickel
C74 Sand black + C74 Sand black
C74 Sand black + C68 Satin nickel

Shade

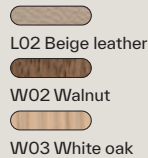
L02 Beige leather
W02 Walnut
W03 White oak



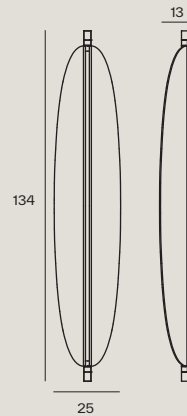

CE  IP 40



562.45 Wall / Ceiling

Hardware

CE  IP 40



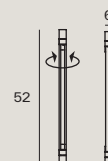

Light source	24V	
Wattage	8W	C22 Beige + C22 Beige
Color temperature	2700k	
Lumens	1000	C22 Beige + C68 Satin nickel
Dimmability	TRIAC, DALI version on request	
Dimensions	H52/D6 cm	
Note	Available with cable and plug Orientable 360°	C74 Sand black + C68 Satin nickel

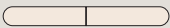

562.46 Wall / Ceiling

Hardware

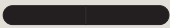
CE  IP 40



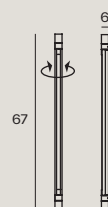

Light source	24V	
Wattage	11W	C22 Beige + C22 Beige
Color temperature	2700k	
Lumens	1400	C22 Beige + C68 Satin nickel
Dimmability	TRIAC, DALI version on request	
Dimensions	H67/D6 cm	
Note	Available with cable and plug Orientable 360°	C74 Sand black + C68 Satin nickel

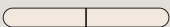

562.47 Wall / Ceiling

Hardware

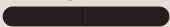
CE  IP 40

Light source	24V	
Wattage	20W	C22 Beige + C22 Beige
Color temperature	2700k	
Lumens	2600	C22 Beige + C68 Satin nickel
Dimmability	TRIAC, DALI version on request	
Dimensions	H104/D6 cm	
Note	Available with cable and plug Orientable 360°	C74 Sand black + C68 Satin nickel

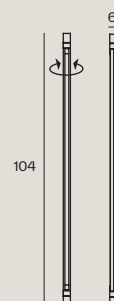

563 Nastro
Designed by Studiopepe.





IT La famiglia di lampade a sospensione, da parete, da terra e da tavolo Nastro progettate da Studiopepe vedono una struttura a fascia in alluminio verniciato a polvere epossidica accompagnarsi a un peso cilindrico che ne controbilancia la flessuosità, in un ricercato equilibrio visivo. La fonte luminosa consiste in una striscia LED dimmerabile; i cilindri sono disponibili in metallo verniciato a polvere epossidica, in legno, in ottone spazzolato e in cemento grezzo.

ENG The Nastro collection of suspension, wall, floor and table lamps designed by Studiopepe sees an epoxy powder coated aluminum band structure accompanied by a cylindrical weight that counterbalances its flexuosity, in a refined visual balance. The light source consists of a dimmable LED strip; the cylinders are available in epoxy powder coated metal, in wood, in brushed brass and in raw concrete.







563.11 Pendant

Light source 1 x E27 220/240V
Wattage (LED) Max 15W
Dimmability According to bulb
Dimensions Ø9/H37 cm
Cable Black fabric
Length 150 cm
Note Max dimension bulb (excluded) Ø8/H11 cm

Hardware

 C74 Sand black
 C23 Eggshell
 C26 Greenish-grey
 C22 Beige
 C25 Terracotta

Cylinder

 C74 Sand black
 C23 Eggshell
 C26 Greenish-grey
 C22 Beige
 C25 Terracotta
 C41 Brushed brass



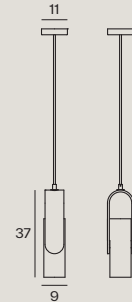

CE  IP 20









563.21 Pendant

Light source 220/240V LED
Wattage 35W
Color temperature 2700k
Lumens 4500
Dimmability TRIAC, Dali version on request
Dimensions L105/W25/H19 cm
Cable Black fabric
Length 110 cm
Steel
Length 125 cm
Note Indirect emission available

Hardware

 C74 Sand black
 C23 Eggshell
 C26 Greenish-grey
 C22 Beige
 C25 Terracotta

Cylinder

 C74 Sand black
 C23 Eggshell
 C26 Greenish-grey
 C22 Beige
 C25 Terracotta
 C41 Brushed brass
 W01 Ash



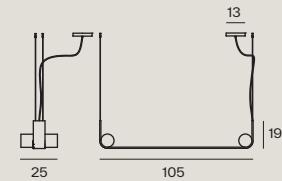

CE  IP 40





563.22 Pendant

Light source 220/240V LED
Wattage 60W
Color temperature 2700k
Lumens 8000
Dimmability TRIAC, Dali version on request
Dimensions L170/W25/H19 cm
Cable Black fabric
Length 110 cm
Steel
Length 125 cm
Note Indirect emission available

Hardware

 C74 Sand black
 C23 Eggshell
 C26 Greenish-grey
 C22 Beige
 C25 Terracotta

Cylinder

 C74 Sand black
 C23 Eggshell
 C26 Greenish-grey
 C22 Beige
 C25 Terracotta
 C41 Brushed brass
 W01 Ash



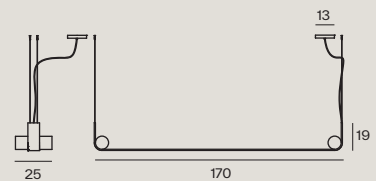

CE  IP 40











563.31 Table

Light source	220/240V LED
Wattage	15W
Color temperature	2700k
Lumens	2000
Dimmability	Dimmable on board
Dimensions	L45/H41/D22 cm
Cable	Black fabric Length 150 cm
Note	Touch dimmer

Hardware

	C74 Sand black
	C23 Eggshell
	C26 Greenish-grey
	C22 Beige
	C25 Terracotta

Cylinder

	C74 Sand black
	C23 Eggshell
	C26 Greenish-grey
	C22 Beige
	C25 Terracotta
	C41 Brushed brass
	W01 Ash
	M01 Concrete



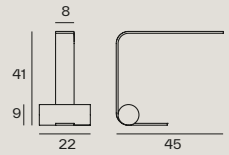

CE ⊕ IP 40











563.32 Table

Light source	220/240V LED
Wattage	15W
Color temperature	2700k
Lumens	2000
Dimmability	Dimmable on board
Dimensions	L47/H41/D22 cm
Cable	Black fabric Length 150 cm
Note	Touch dimmer

Hardware

	C74 Sand black
	C23 Eggshell
	C26 Greenish-grey
	C22 Beige
	C25 Terracotta

Cylinder

	C74 Sand black
	C23 Eggshell
	C26 Greenish-grey
	C22 Beige
	C25 Terracotta
	C41 Brushed brass
	W01 Ash
	M01 Concrete



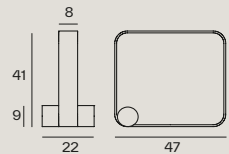

CE ⊕ IP 40











563.41 Wall

Light source	220/240V LED
Wattage	13W
Color temperature	2700k
Lumens	1700
Dimmability	TRIAC, DALI version on request
Dimensions	L22/H50/D21 cm
Note	Outdoor version available IP44 Can be installed upside down

Hardware

	C74 Sand black
	C23 Eggshell
	C26 Greenish-grey
	C22 Beige
	C25 Terracotta







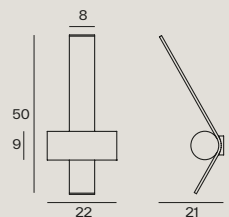

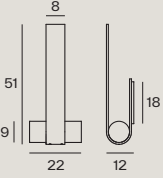

Cylinder

	C74 Sand black
	C23 Eggshell
	C26 Greenish-grey
	C22 Beige
	C25 Terracotta
	C41 Brushed brass
	W01 Ash
	M01 Concrete

CE ⊕ IP 40











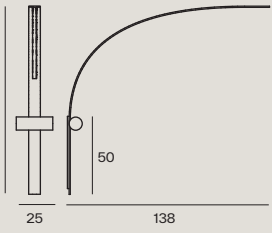

563.42 Wall

		Hardware	Cylinder	CE  IP 40
Light source	220/240V LED			
Wattage	17W	C74 Sand black	C74 Sand black	
Color temperature	2700k			
Lumens	2300	C23 Eggshell	C23 Eggshell	
Dimmability	TRIAC, Dali version on request			
Dimensions	L22/H51/D12 cm	C26 Greenish-grey	C26 Greenish-grey	
Note	Outdoor version available IP44	C22 Beige	C22 Beige	
			C25 Terracotta	
				
				

563.43 Wall

		Hardware	Cylinder	CE  IP 40
Light source	220/240V LED			
Wattage	17W	C74 Sand black	C74 Sand black	
Color temperature	2700k			
Lumens	2300	C23 Eggshell	C23 Eggshell	
Dimmability	TRIAC, DALI version on request			
Dimensions	L22/H49/D15 cm	C26 Greenish-grey	C26 Greenish-grey	
Note	Outdoor version available IP44	C22 Beige	C22 Beige	
			C25 Terracotta	
				
				





563.46 Wall

		Hardware	Cylinder	CE  IP 40
Light source	220/240V LED			
Wattage	63W	C74 Sand black	C74 Sand black	
Color temperature	2700k			
Lumens	8300	C23 Eggshell	C23 Eggshell	
Dimmability	TRIAC, Dali version on request			
Dimensions	L25/H129/D138 cm	C26 Greenish-grey	C26 Greenish-grey	
		C22 Beige	C22 Beige	
			C25 Terracotta	
				
				







563.47 Wall

Light source	220/240V LED
Wattage	43W
Color temperature	2700k
Lumens	6000
Dimmability	TRIAC, Dali version on request
Dimensions	L25/H129/D193 cm
Cable	Steel Length 125 cm

Hardware

	C74 Sand black
	C23 Eggshell
	C26 Greenish-grey
	C22 Beige
	C25 Terracotta

Cylinder

	C74 Sand black
	C23 Eggshell
	C26 Greenish-grey
	C22 Beige
	C25 Terracotta
	C41 Brushed brass
	W01 Ash



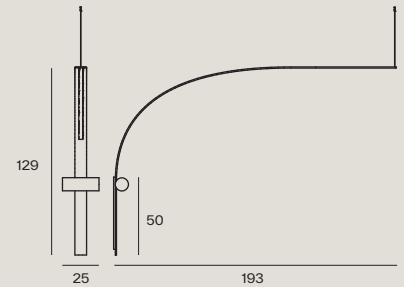

CE ⊕ IP 40









563.61 Floor

Light source	220/240V LED
Wattage	9W
Color temperature	2700k
Lumens	1100
Dimmability	Integrated dimmer on cable
Dimensions	L30/H145/W47 cm
Cable	Black fabric Length 300 cm

Hardware

	C74 Sand black
	C23 Eggshell
	C26 Greenish-grey
	C22 Beige
	C25 Terracotta

Cylinder

	C74 Sand black
	C23 Eggshell
	C26 Greenish-grey
	C22 Beige
	C25 Terracotta
	C41 Brushed brass
	W01 Ash



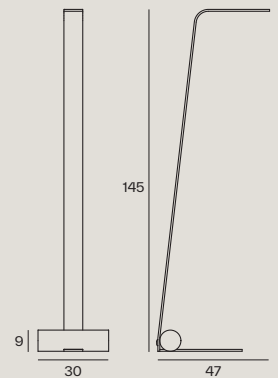

CE ⊕ IP 40











563.62 Floor

Light source	220/240V LED
Wattage	50W
Color temperature	2700k
Lumens	6500
Dimmability	Integrated dimmer on cable
Dimensions	L30/H128/W25 cm
Cable	Black fabric Length 300 cm
Note	Outdoor version available IP44

Hardware

	C74 Sand black
	C23 Eggshell
	C26 Greenish-grey
	C22 Beige
	C25 Terracotta







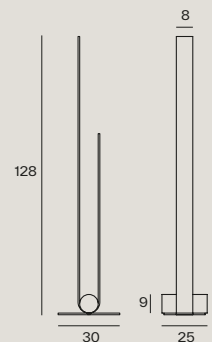





Cylinder

	C74 Sand black
	C23 Eggshell
	C26 Greenish-grey
	C22 Beige
	C25 Terracotta
	C41 Brushed brass
	W01 Ash
	M01 Concrete

CE ⊕ IP 40



563.63 Floor

		Hardware	Cylinder
Light source	220/240V LED		
Wattage	49W	C74 Sand black	C74 Sand black
Color temperature	2700k		
Lumens	6900	C23 Eggshell	C23 Eggshell
Dimmability	Integrated dimmer on cable		
Dimensions	L97/H197/W38 cm	C26 Greenish-grey	C26 Greenish-grey
Cable	Black fabric Length 300 cm		
		C22 Beige	C22 Beige
			
		C25 Terracotta	C25 Terracotta
			C41 Brushed brass
			W01 Ash

CE  IP 40

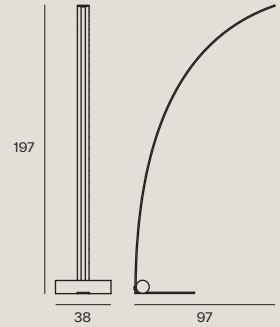

563.64 Floor

		Hardware	Cylinder
Light source	220/240V LED		
Wattage	67W	C74 Sand black	C74 Sand black
Color temperature	2700k		
Lumens	9500	C23 Eggshell	C23 Eggshell
Dimmability	Integrated dimmer on cable		
Dimensions	L179/H207/W38 cm	C26 Greenish-grey	C26 Greenish-grey
Cable	Black fabric Length 300 cm		
		C22 Beige	C22 Beige
			
		C25 Terracotta	C25 Terracotta
			C41 Brushed brass
			W01 Ash

CE  IP 40

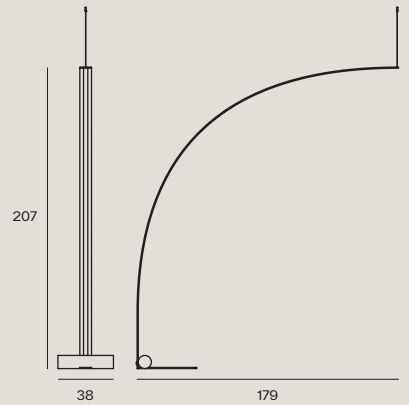

Publication edited by
TOOY

Concept and art direction by
STUDIOPEPE.

Styling
GRETA CEVENINI

Pictures by
SILVIA RIVOLTELLA

Texts by
ELENA RAVERA

Translations by
TOOY

Graphic Design by
ATTO

Printing by
GRAFICHE ANTIGA

Thanks to
ALESSI
AYTM
BLOC STUDIOS
BONACINA 1889
CC-TAPIS
CERAMICA FLAMINIA
CERAMICAH
CERAMICAROSA
CIMENTO
DOMENICO OREFICE DESIGN STUDIO
DWA DESIGN STUDIO
EXTETA
FEDERICA BUBANI
GALLOTTI&RADICE
KNINDUSTRIE SRL
LIVING DIVANI
MAMATE
MANERBA
MDF ITALIA
MINOTTI
MMAIRO
MOROSO
PIETRO RUSSO DESIGN STUDIO
PULPO
ROSA AGNESE ARTALE
SALVIATI
SARAH RICHIUSO
SOVRAPPENSIERO DESIGN STUDIO
SPOTTI
TACCHINI ITALIA FURNITURE
TWILS
VITRA

Printed in Italy, August 2021

SUNRISE

MIDDAY

SUNSET

MIDNIGHT



MEZZANOTTE

TRAMONTO

MEZZOGIORNO

ALBA