

AI LIGHTS
LATTI

zafferano

BESPOKE

LUCE

2020.2021

2020-2021

AI LIGHTS
LATTI



BESPOKE

“ Sono cresciuto tra la bellezza di Venezia e l'incanto della sua laguna. A Murano, nella fornace di famiglia, ho imparato ad amare il vetro, materia delicata e potente; nel mio percorso imprenditoriale, ho esplorato e compreso l'importanza della luce per il benessere dell'uomo. La mia filosofia di progetto si fonda su tre capisaldi: l'influenza della bellezza culturale e naturale italiana, che da sempre ispira il nostro design; il rispetto per il genio artigiano, una millenaria pratica del "saper fare" che il mondo ci invidia; e la curiosità inesauribile per le opportunità offerte da materiali e tecnologie d'avanguardia. Dalla sintesi di questi temi nascono tutti i miei progetti: il nuovo catalogo "Luce 2020-2021" raccoglie in un unico volume le collezioni di illuminazione AiLati e Zafferano Bespoke, ciascuna contraddistinta dalla propria identità, ma accomunate dal costante impegno a creare prodotti funzionali e dalla valenza estetica senza tempo. ”

“ I grew up amid the beauty of Venice and its enchanting lagoon. On the island of Murano, at the family-run glassworks, I learned to love glass, a delicate and powerful material. Throughout my business career, I have explored and understood the importance of light for human well-being. My design philosophy is based on three cornerstones: the influence of Italian cultural and natural beauty, which has always inspired our design; respect for artisan talent, age-old know-how envied by the rest of the world; and the endless curiosity in pursuing the opportunities offered by cutting-edge materials and technologies. A combination of these factors has given rise to all my projects: in a single publication, the new "Luce 2020-2021" catalogue brings together AiLati and Zafferano Bespoke lighting collections, each one with its own identity yet united by the constant commitment to create functional products with timeless aesthetic appeal. ”



AI
LIGHTS
LATI

AiLati è il marchio di Zafferano dedicato all'illuminazione d'interni e da esterni, connotato da una specializzazione in ambito decorativo e tecnico.

I prodotti si distinguono per i colori neutri e le linee geometriche, pulite e minimaliste, rese principalmente attraverso il vetro opale, combinato ad altri materiali di alta qualità. La progettazione prevede avanzati standard tecnologici: l'adozione di sorgenti luminose a LED di nuova generazione; lo studio di sistemi semplici e veloci di assemblaggio e fissaggio; l'uso di materiali durevoli; alti indici di protezione. Sono tutti elementi che contribuiscono a migliorare l'efficienza dei corpi illuminanti, aumentare la durata e la qualità della luce e ottimizzare la reale economia di gestione, soprattutto quando gli apparecchi sono installati in grandi quantità.

Il contract è dunque la vocazione naturale di questi modelli, anche stilisticamente di immediato inserimento in ambienti diversi: dagli spazi privati a quelli pubblici, dai luoghi dedicati all'accoglienza, al retail e agli uffici.

AiLati is the Zafferano brand dedicated to indoor and outdoor lighting, specialised in decorative and technical lighting solutions.

AiLati products stand out for their neutral colours and minimalist, clean-cut geometric lines, mainly achieved with opal glass combined with other high-quality materials. Their design involves state-of-the-art technological standards: the use of new generation LED light sources; research into quick and simple assembly and fixing systems; the use of long-lasting materials; and high IP ratings. All these features play an important role in improving the efficiency of luminaires, increasing the life and quality of light while optimising operating costs, especially when large-scale lighting systems are installed.

The contract-furnishing sector is therefore the natural choice for these luminaires, which can be stylistically incorporated in a variety of contexts: from private and public spaces to places such as hospitality facilities, retail spaces and offices.

zafferano
BESPOKE

Zafferano Bespoke è la divisione dedicata all'illuminazione decorativa per interni, pensata per la realizzazione di progetti su misura.

Le collezioni a catalogo - originali, colorate e dotate di forte personalità - sono accomunate dalla possibilità di personalizzazione e dalla componibilità, che consentono innumerevoli soluzioni creative nella progettazione di piccole e grandi installazioni. Ogni dettaglio, dalle varianti cromatiche alle finiture dei metalli, può essere adattato e modulato in base alle esigenze funzionali e di gusto, per creare infinite varianti di forma e distribuzione.

Per queste peculiarità, le collezioni Zafferano Bespoke permettono di creare ambientazioni di forte carattere esclusivo ed emozionale, attraverso seducenti effetti decorativi di luce e colore, e trovano il loro perfetto inserimento nelle forniture speciali per hotel e grandi spazi.

Zafferano Bespoke is the division dedicated to interior decor lighting, specifically focused on creating tailor-made projects.

The catalogue collections - original, colourful and with a great personality - can all be customised and include modular elements, allowing a multitude of creative solutions for designing small - and large - scale lighting installations. All details, from colour options to metal finishes, can be adapted and shaped to suit functional needs and tastes, thus creating endless variations in shape and composition.

Thanks to these special features, Zafferano-Bespoke collections allow distinctly exclusive and striking interiors to be created, with eye-catching decorative effects of light and colour. They can be perfectly incorporated in customised lighting projects for hotels and large spaces.

OUTDOOR

| | |
|------------|------------------|
| ALU | <u>24</u> |
| ASTUCCIO | <u>78</u> |
| BIANCA | <u>62</u> |
| BOTTOM | <u>68</u> |
| CIOTTOLO | <u>8</u> |
| CONCHIGLIA | <u>30</u> |
| CUBETTO | <u>82</u> |
| GABBIANO | <u>18</u> |
| GIRASOLE | <u>70</u> |
| HOME | <u>38</u> |
| LENS | <u>14</u> |
| OVALINO | <u>74</u> |
| RIGA | <u>50</u> |
| SLAT | <u>44</u> |
| SOLAR | <u>20</u> |
| SOLE | <u>56</u> |
| SOTTOSOPRA | <u>66</u> |
| STOLA | <u>52</u> |
| TACK | <u>72</u> |
| TUNNEL | <u>34</u> |

INDOOR

| | |
|------------------|-------------------|
| BIS | <u>210</u> |
| BIS BAYONET | <u>212</u> |
| BOX QUADRATA | <u>216</u> |
| BOX ROTONDA | <u>214</u> |
| BRIDGE | <u>130</u> |
| CALEIDO | <u>132</u> |
| CAORLE | <u>170</u> |
| CHIUSA | <u>202</u> |
| CIP | <u>128</u> |
| CONCA | <u>108</u> |
| CUBETTO | <u>126</u> |
| DADO | <u>166</u> |
| DRUM | <u>204</u> |
| DRUM BAYONET | <u>208</u> |
| DRUM METAL | <u>206</u> |
| ECLIPSE QUADRATA | <u>122</u> |
| ECLIPSE TONDA | <u>118</u> |
| LUCCA | <u>176</u> |
| MENTOS | <u>152</u> |
| MINE | <u>136</u> |
| OMEGA | <u>186</u> |
| PALLINA | <u>162</u> |
| RASO | <u>106</u> |
| RIALTO | <u>172</u> |
| RIGA | <u>112</u> |
| SFERIS | <u>156</u> |
| SIXTIES | <u>140</u> |
| SPICCHIO | <u>200</u> |
| STAND | <u>182</u> |
| STAND METAL | <u>184</u> |
| STICK | <u>188</u> |
| STRIPE | <u>88</u> |
| TREVISO | <u>144</u> |

INDOOR

| | |
|-------------------|-------------------|
| BALLOON | <u>246</u> |
| BONNIE E CLIDE | <u>264</u> |
| CAMOUFLAGE | <u>220</u> |
| LAGUNA | <u>250</u> |
| LUCE LIQUIDA | <u>254</u> |
| MARIPOSA | <u>288</u> |
| MERLINO | <u>242</u> |
| ONDA | <u>270</u> |
| PERLE | <u>282</u> |
| REGOLO | <u>280</u> |
| ROMEO E GIULIETTA | <u>258</u> |
| SEVENTIES | <u>232</u> |
| SHOW | <u>276</u> |

| | |
|-----------------|-------------------|
| RELAMPING KIT | <u>306</u> |
| ROSONI/CANOPIES | <u>310</u> |
| SIMBOLI/SYMBOLS | <u>311</u> |

AI LIGHTS
LATTI

OUTDOOR

Collezioni di lampade per uso esterno e interno.

Collection of lamps for outdoor and indoor use.

CIOTTOLO





CIOTTOLO



G3
Grigio scuro
Dark grey



R3
Corten

Lampade da terra e da parete con struttura in pressofusione di alluminio verniciato grigio scuro o corten e diffusore in policarbonato opalino satinato.

L'elevato grado di protezione (IP54) rende il prodotto adatto all'uso esterno ed interno.

Wall and floor lamps with a dark grey or corten painted die-cast aluminium frame and a satin-finish opaline polycarbonate diffuser.

The high IP rating (IP54) makes the lamps ideal for indoor and outdoor use.

Parete / Wall

LD0480 LED

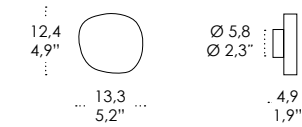

| LED 3000K CRI>80 220-240V IP54 | | | | | | | CE |
|--------------------------------|----------|------|---------|--------|---------|------------|----|
| COD. | FINISHES | WATT | TOTAL W | Lm LED | Lm LAMP | BEAM ANGLE | |
| LD0480 | G3 - R3 | 7W | 7 W | 875 lm | 320 lm | 90° | |

Terra / Floor

LD0483 LED

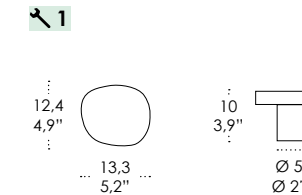

| LED 3000K CRI>80 220-240V IP54 | | | | | | | CE |
|--------------------------------|----------|------|---------|--------|---------|------------|----|
| COD. | FINISHES | WATT | TOTAL W | Lm LED | Lm LAMP | BEAM ANGLE | |
| LD0483 | G3 - R3 | 7W | 7 W | 875 lm | 320 lm | 90° | |
| LD0485 | G3 - R3 | 7W | 7 W | 875 lm | 300 lm | 90° | |

LD0485 LED

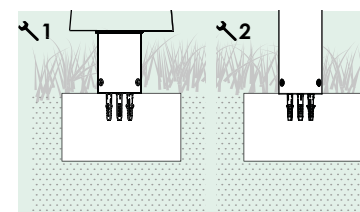
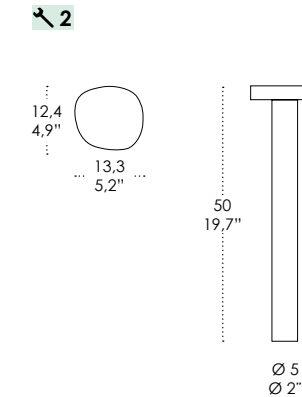

Metodo di fissaggio corretto:
Lampada fissata su un plinto in cemento con viti di fissaggio idonee.
Correct fixing procedure:
Lamp fixed to a cement plinth with suitable anchor bolts or screws.

Modalità di installazioni differenti da quelle illustrate sono da ritenersi non idonee.
Installation procedures other than those illustrated are considered unsuitable.

LENS





LD0750G3

LENS



Lampade da parete e da soffitto con struttura in pressofusione di alluminio verniciato grigio scuro o bianco e diffusore in vetro trasparente. L'elevato grado di protezione (IP65) rende il prodotto adatto all'uso esterno ed interno.

Wall and ceiling lamps with a dark grey or white painted die-cast aluminium frame and a transparent glass diffuser. The high IP rating (IP65) makes the lamps ideal for indoor and outdoor use.

Parete / Wall

LD0751 LED

Mono emissione
Single emission

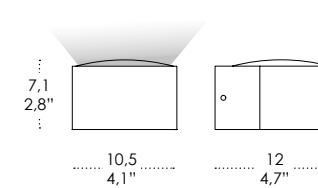

LD0752 LED

Bi emissione
Double emission

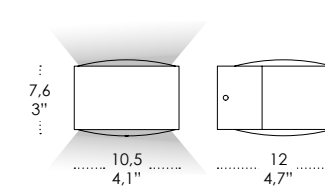

| LED 3000K CRI>80 220-240V IP65 | | | | | | | CE |
|--------------------------------|----------|---------|---------|------------|------------|------------|----|
| COD. | FINISHES | WATT | TOTAL W | Lm LED | Lm LAMP | BEAM ANGLE | |
| LD0751 | B3 - G3 | 5 W | 6 W | 510 lm | 480 lm | 100° | |
| LD0752 | B3 - G3 | 2 x 5 W | 2 x 6 W | 2 x 510 lm | 2 x 480 lm | 100° | |

Soffitto / Ceiling

LD0750 LED

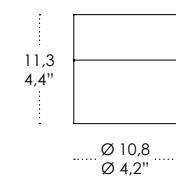

| LED 3000K CRI>80 220-240V IP65 | | | | | | | CE |
|--------------------------------|----------|------|---------|--------|---------|------------|----|
| COD. | FINISHES | WATT | TOTAL W | Lm LED | Lm LAMP | BEAM ANGLE | |
| LD0750 | B3 - G3 | 5 W | 6,5 W | 600 lm | 250 lm | 45° | |

GABBIANO

DESIGN_ Federico de Majo



LD0820B3



B3
Bianco
White



R3
Corten

Lampada da parete con struttura in pressofusione di alluminio verniciato bianco o corten, diffusore in vetro prismatico satinato.
L'elevato grado di protezione (IP54) rende il prodotto adatto all'uso esterno ed interno.



Wall lamp with a white or corten painted die-cast aluminium frame and a prismatic glass diffuser. The high IP rating (IP54) makes the lamp ideal for indoor and outdoor use.

Parete / Wall

LD0820 

32
12.6"



| LED DIMMER  3000K CRI>90 220-240V   | | | | | | | |
|----------------------------------------------------------------------------------------------------------------------------------------------------------------------------------------------------------------------------------------------------------------------------------------------------|----------------|-----------|----------|---------------|--------------|------------|--------|
| COD. | FINISHES | WATT | TOTAL W | Lm LED | Lm LAMP | BEAM ANGLE | DIMMER |
| LD0820 | B3 - R3 | 9 + 4,5 W | 11 + 6 W | 1000 + 500 lm | 725 + 395 lm | 120° | TRIAC |

SOLAR



SOLAR LD0402G3



SOLAR LD0400G3

SOLAR



G3
Grigio scuro
Dark grey

Lampade da terra e da parete con struttura in pressofusione d'alluminio verniciato grigio scuro e diffusore in policarbonato.

L'elevato grado di protezione (IP54 e IP65) rende il prodotto adatto all'uso esterno ed interno.

Le lampade sono dotate di pannello solare che carica la batteria e sensore crepuscolare (prodotto privo di collegamento alla rete elettrica perché autoalimentato). Batteria sostituibile.

Wall and floor lamps in dark grey painted die-cast aluminium, with a polycarbonate diffuser.

The high IP rating (IP54 and IP65) makes the lamps ideal for indoor and outdoor use.

The lamps are fitted with a solar panel that auto-charges the battery and a dusk sensor (this product has no connection for the electrical mains as it is auto-powered). Replaceable battery.

Parete / Wall Dotata di sensore crepuscolare e di movimento / Fitted with dusk and motion sensors

LD0400 LED

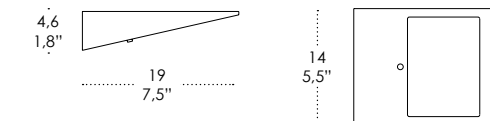

| LED 3000K CRI>80 IP54 | | | | | | | CE |
|-----------------------|----------|-------|---------|--------|---------|------------|----|
| COD. | FINISHES | WATT | TOTAL W | Lm LED | Lm LAMP | BEAM ANGLE | |
| LD0400 | G3 | 2,2 W | 2,2 W | 278 lm | 195 lm | 107° | |

Ricarica / Charge: 6-8 h (luce solare / sunshine)
Durata batteria / Work time: luce piena 2,5 - 3h; micro 20 - 25h / Full light 2,5 - 3h; micro light 20 - 25h

Terra / Floor Dotata di sensore crepuscolare e di movimento / Fitted with dusk and motion sensors

LD0402 LED

1/2

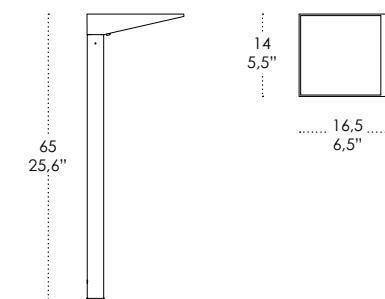

| LED 3000K CRI>80 IP54 | | | | | | | CE |
|-----------------------|----------|-------|---------|--------|---------|------------|----|
| COD. | FINISHES | WATT | TOTAL W | Lm LED | Lm LAMP | BEAM ANGLE | |
| LD0402 | G3 | 2,2 W | 2,2 W | 278 lm | 143 lm | 68° | |

Ricarica / Charge: 6-8 h (luce solare / sunshine)
Durata batteria / Work time: luce piena 2,5 - 3h; micro 20 - 25h / Full light 2,5 - 3h; micro light 20 - 25h

Terra / Floor Dotata di sensore crepuscolare / Fitted with dusk sensors

LD0404 LED

3

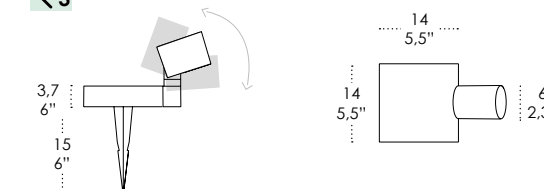

| LED 3000K CRI>80 IP65 | | | | | | | CE |
|-----------------------|----------|-------|---------|--------|---------|------------|----|
| COD. | FINISHES | WATT | TOTAL W | Lm LED | Lm LAMP | BEAM ANGLE | |
| LD0404 | G3 | 1,3 W | 1,3 W | 110 lm | 81 lm | 28° | |

Ricarica / Charge: 5-8 h (luce solare / sunshine)
Durata batteria / Work time: 7 h

1

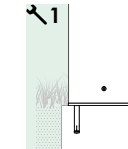

Metodo di fissaggio corretto:
Lampada fissata su un plinto in cemento con tirafondi o viti idonee.
Correct fixing procedure:
Lamp fixed to a cement plinth with suitable anchor bolts or screws.

2

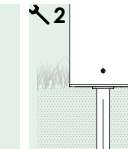

Metodo di fissaggio corretto:
Lampada fissata sul terreno con picchetto in metallo.
Correct fixing procedure:
Lamp fixed in the ground with a metal peg.

3

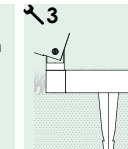

Metodo di fissaggio corretto:
Lampada fissata sul terreno con picchetto in metallo.
Correct fixing procedure:
Lamp fixed in the ground with a metal peg.

Modalità di installazioni differenti da quelle illustrate sono da ritenersi non idonee.
Installation procedures other than those illustrated are considered unsuitable.

ALU



ALU LD0136G3

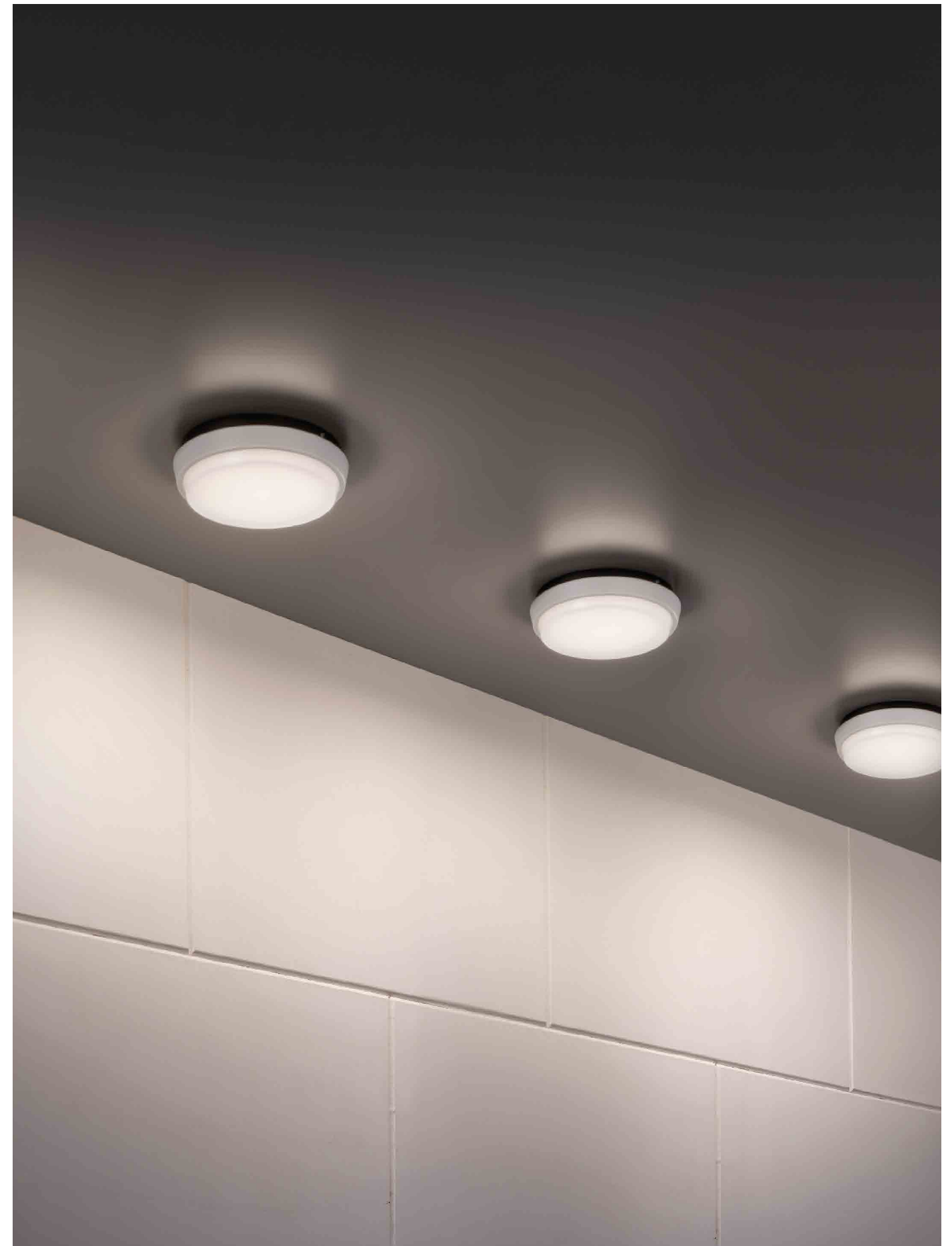

ALU LD0131B3



ALU



B3
Bianco
White



G3
Grigio scuro
Dark grey

Lampade da parete e da parete-soffitto con struttura in pressofusione di alluminio verniciato nei colori bianco opaco o grigio scuro, diffusore in policarbonato opalino satinato. L'elevato grado di protezione (IP54) rende il prodotto adatto all'uso esterno ed interno.

Wall and wall-ceiling lamps with a matt white or dark grey painted die-cast aluminium frame and a satin-finish opaline polycarbonate diffuser. The high IP rating (IP54) makes the lamps ideal for indoor and outdoor use.



Parete / Wall

LD0138 LED

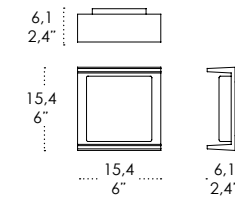

| LED 3000K CRI>80 220-240V IP54 CE | | | | | | |
|----------------------------------------------------------------------|----------|------|---------|--------|---------|------------|
| COD. | FINISHES | WATT | TOTAL W | Lm LED | Lm LAMP | BEAM ANGLE |
| LD0138 | B3 - G3 | 7 W | 8 W | 800 lm | 480 lm | 105° |

Parete-soffitto / Wall-ceiling

LD0135 LED

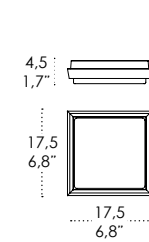

LD0136 LED

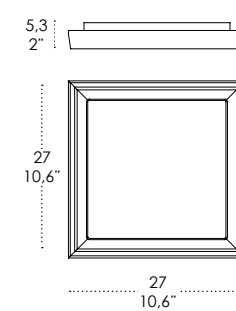

LD0137 LED

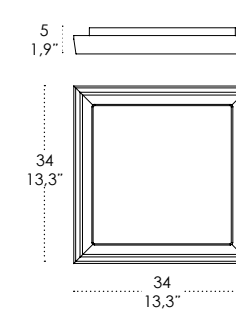

| LED 3000K CRI>80 220-240V IP54 CE | | | | | | |
|----------------------------------------------------------------------|----------|--------|---------|---------|---------|------------|
| COD. | FINISHES | WATT | TOTAL W | Lm LED | Lm LAMP | BEAM ANGLE |
| LD0135 | B3 - G3 | 8,4 W | 10 W | 900 lm | 760 lm | 110° |
| LD0136 | B3 - G3 | 23,8 W | 25 W | 2500 lm | 2160 lm | 110° |
| LD0137 | B3 - G3 | 27,3 W | 30 W | 3000 lm | 2350 lm | 110° |

Parete-soffitto / Wall-ceiling

LD0130 LED

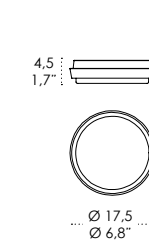

LD0131 LED

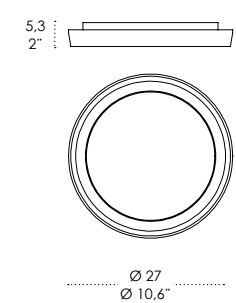

LD0132 LED

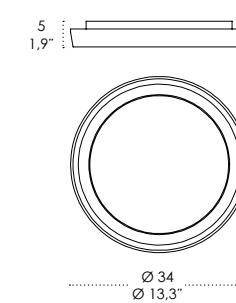

| LED 3000K CRI>80 220-240V IP54 CE | | | | | | |
|----------------------------------------------------------------------|----------|--------|---------|---------|---------|------------|
| COD. | FINISHES | WATT | TOTAL W | Lm LED | Lm LAMP | BEAM ANGLE |
| LD0130 | B3 - G3 | 8,4 W | 10 W | 900 lm | 760 lm | 110° |
| LD0131 | B3 - G3 | 23,8 W | 25 W | 2500 lm | 2160 lm | 110° |
| LD0132 | B3 - G3 | 27,3 W | 30 W | 3000 lm | 2350 lm | 110° |

CONCHIGLIA





CONCHIGLIA



B3
Bianco
White



G3
Grigio scuro
Dark grey

Lampade da parete-soffitto con struttura in pressofusione d'alluminio verniciato bianco o grigio scuro opaco, diffusore in policarbonato bianco.

L'elevato grado di protezione (IP54) rende il prodotto adatto all'uso esterno ed interno. Il diffusore della lampada può essere orientato per ottenere l'effetto luminoso desiderato.

Wall-ceiling lamps with a matt white or dark grey painted die-cast aluminium, a polycarbonate diffuser.

The high IP rating (IP54) makes the lamps ideal for indoor and outdoor use.

The diffuser can be adjusted to achieve the required luminous intensity.

Parete-soffitto / Wall-ceiling

LD0430 LED

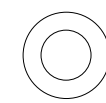

∅ 16
∅ 6.3"



6,2
2,4"

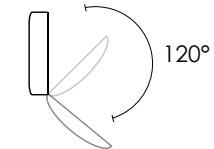

Lampada regolabile
Adjustable lamp

| LED 3000K CRI>80 220-240V IP54 | | | | | | CE |
|--------------------------------|----------------|------|---------|--------|---------|------------|
| COD. | FINISHES | WATT | TOTAL W | Lm LED | Lm LAMP | BEAM ANGLE |
| LD0430 | B3 - G3 | 6 W | 8 W | 840 lm | 630 lm | 80° |

TUNNEL



TUNNEL



B3
Bianco
White



G3
Grigio scuro
Dark grey

Lampade da parete con struttura in alluminio verniciato bianco opaco o grigio scuro e diffusore in policarbonato trasparente.
L'elevato grado di protezione (IP54) rende il prodotto adatto all'uso esterno ed interno.

Wall lamps with a matt white or dark grey painted aluminium frame and a clear finish polycarbonate diffuser.
The high IP rating (IP54) makes the lamps ideal for indoor and outdoor use.

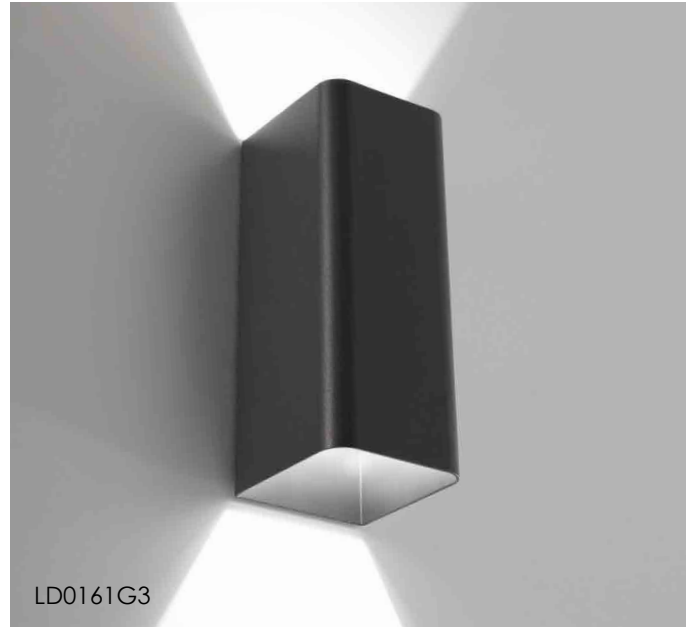

BFO
Bianco/White



BFA
Bianco/White



BFR
Bianco/White



GFO
Grigio scuro
Dark grey



GFA
Grigio scuro
Dark grey



GFR
Grigio scuro
Dark grey

Foglia color
oro/
Gold colour
leaf

Foglia color
argento/
Silver colour
leaf

Foglia color
rame/
Copper
colour leaf

Foglia color
oro/
Gold colour
leaf

Foglia color
argento/
Silver colour
leaf

Foglia color
rame/
Copper
colour leaf

Versioni con finitura artigianale "a foglia" solo per uso interno.
Versions with artisanal "leaf" finish suitable for indoor use only.



Parete / Wall

LD0161 **LED**

LD0162 **LED**

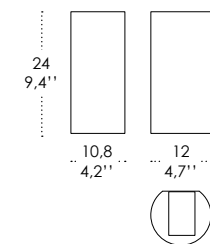
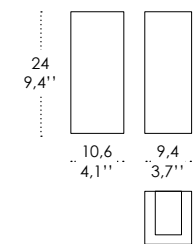

| LED 3000K CRI>80 220-240V IP54 | | | | | | | CE |
|--------------------------------|----------|---------|---------|------------|------------|------------|----|
| COD. | FINISHES | WATT | TOTAL W | Lm LED | Lm LAMP | BEAM ANGLE | |
| LD0161 | B3 - G3 | 2 x 6 W | 2 x 7 W | 2 x 680 lm | 2 x 260 lm | 70° | |
| LD0162 | B3 - G3 | 2 x 6 W | 2 x 7 W | 2 x 680 lm | 2 x 260 lm | 70° | |

Parete / Wall

LD0161 **LED**

LD0162 **LED**

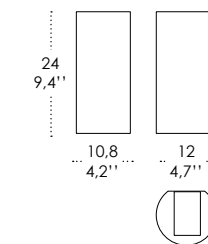
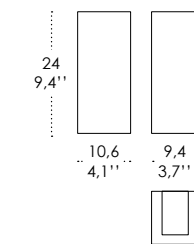

| LED 3000K CRI>80 220-240V IP54 | | | | | | | CE |
|--------------------------------|----------------------------|---------|---------|------------|------------|------------|----|
| COD. | FINISHES | WATT | TOTAL W | Lm LED | Lm LAMP | BEAM ANGLE | |
| LD0161 | BFO/BFA/BFR GFO/GFA/GFR | 2 x 6 W | 2 x 7 W | 2 x 680 lm | 2 x 260 lm | 70° | |
| LD0162 | BFO/BFA/BFR GFO/GFA/GFR | 2 x 6 W | 2 x 7 W | 2 x 680 lm | 2 x 260 lm | 70° | |

HOME





HOME



Lampade da parete-soffitto e da terra con struttura in pressofusione di alluminio verniciato bianco opaco, grigio scuro o corten, diffusore in vetro pressato bianco satinato (parete-soffitto) e policarbonato trasparente (terra). L'elevato grado di protezione (IP54 e IP65) rende il prodotto adatto all'uso esterno ed interno.

Wall-ceiling and floor lamps with a matt white, dark grey or corten painted die-cast aluminium frame, a satin-finish white cast glass (wall-ceiling) or transparent polycarbonate (floor) diffuser. The high IP rating (IP54) makes the lamps ideal for indoor and outdoor use.

Parete-soffitto / Wall-ceiling

LL0250
LD0250

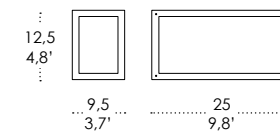

| E27 220-240V | | | | CE |
|--------------|--------------|-----------------|----------|----|
| COD. | FINISHES | LAMP CONNECTION | WATT MAX | |
| LL0250 | B3 - G3 - R3 | 1 x E27 | 42 W HS | |

| LED 3000K CRI>80 220-240V | | | | | | | CE |
|---------------------------|--------------|-------|---------|---------|---------|------------|----|
| COD. | FINISHES | WATT | TOTAL W | Lm LED | Lm LAMP | BEAM ANGLE | |
| LD0250 | B3 - G3 - R3 | 8,7 W | 10 W | 1310 lm | 480 lm | 120° | |

LED 2700K - 4000K su richiesta / on request

Parete-soffitto / Wall-ceiling

LL0251
LD0251

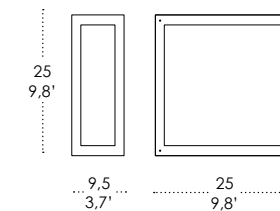

| E27 220-240V | | | | CE |
|--------------|--------------|-----------------|-------------|----|
| COD. | FINISHES | LAMP CONNECTION | WATT MAX | |
| LL0251 | B3 - G3 - R3 | 2 x E27 | 2 x 42 W HS | |

| LED 3000K CRI>80 220-240V | | | | | | | CE |
|---------------------------|--------------|--------|---------|---------|---------|------------|----|
| COD. | FINISHES | WATT | TOTAL W | Lm LED | Lm LAMP | BEAM ANGLE | |
| LD0251 | B3 - G3 - R3 | 17,5 W | 20 W | 2620 lm | 1060 lm | 130° | |

LED 2700K - 4000K su richiesta / on request

Terra / Floor

LD0254

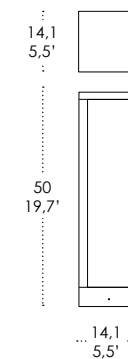

| LED 3000K CRI>80 220-240V | | | | | | | CE |
|---------------------------|----------|------|---------|--------|---------|------------|----|
| COD. | FINISHES | WATT | TOTAL W | Lm LED | Lm LAMP | BEAM ANGLE | |
| LD0254 | G3 - R3 | 15 W | 15 W | 856 lm | 856 lm | 100° | |

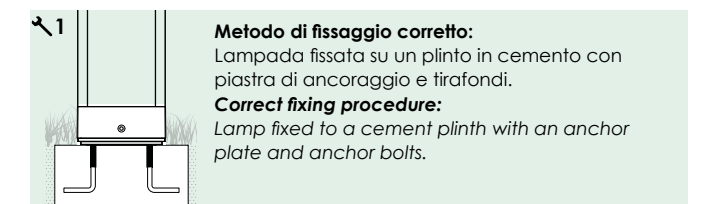

Modalità di installazioni differenti da quelle illustrate sono da ritenersi non idonee.
Installation procedures other than those illustrated are considered unsuitable.



HOME LD0254R3

SLAT







SLAT



Lampade da parete e da terra, con struttura in pressofusione di alluminio verniciato bianco opaco, grigio scuro o corten, diffusore in policarbonato. L'elevato grado di protezione (IP54 e IP65) rende il prodotto adatto all'uso esterno ed interno.

Wall and floor lamps with a matt white, dark grey or corten painted die-cast aluminium frame and a satin finish polycarbonate diffuser. The high IP rating (IP54 and IP65) makes the lamps ideal for indoor and outdoor use.

Parete / Wall

LD0150 LED Mono emissione / Single emission

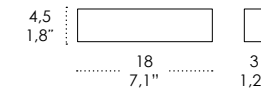

LD0152 LED Bi emissione / Double emission

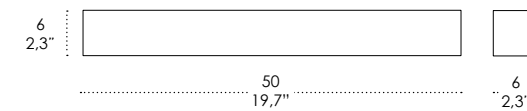

| LED 3000K CRI>80 220-240V IP65 CE | | | | | | |
|----------------------------------------------------------------------|---------------|---------|----------|------------|------------|------------|
| COD. | FINISHES | WATT | TOTAL W | Lm LED | Lm LAMP | BEAM ANGLE |
| LD0150 | B3 - G3 R3 | 7,8 W | 8 W | 322 lm | 322 lm | 70° |
| LD0152 | B3 - G3 R3 | 2 x 9 W | 2 x 10 W | 2 x 909 lm | 2 x 750 lm | 107° |

Terra / Floor

LD0154 LED Mono emissione / Single emission

LD0155 LED Bi emissione / Double emission

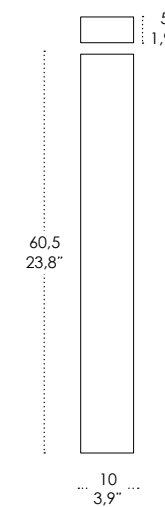

| LED 3000K CRI>80 100-240V IP54 CE | | | | | | |
|----------------------------------------------------------------------|----------|---------|-----------|------------|------------|------------|
| COD. | FINISHES | WATT | TOTAL W | Lm LED | Lm LAMP | BEAM ANGLE |
| LD0154 | G3 | 6 W | 7 W | 660 lm | 530 lm | 100° |
| LD0155 | G3 | 2 x 6 W | 2 x 6,5 W | 2 x 660 lm | 2 x 500 lm | 100° |



Metodo di fissaggio corretto:

Lampada fissata su un plinto in cemento con viti di fissaggio idonee.

Correct fixing procedure:

Lamp fixed to a cement plinth with suitable anchor bolts or screws.



Modalità di installazioni differenti da quelle illustrate sono da ritenersi non idonee. Installation procedures other than those illustrated are considered unsuitable.

RIGA



B3
Bianco
White



G3
Grigio scuro
Dark grey

Lampade da parete-soffitto con struttura in pressofusione di alluminio verniciato bianco opaco o grigio scuro e diffusore in policarbonato satinato.

L'elevato grado di protezione (IP54) rende il prodotto adatto all'uso esterno ed interno.

Wall-ceiling lamps with a matt white or dark grey painted die-cast aluminium frame and a satin finish polycarbonate diffuser.

The high IP rating (IP54) makes the lamps ideal for indoor and outdoor use.

Parete-soffitto / Wall-ceiling

LD0108

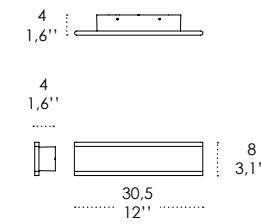

LD0109

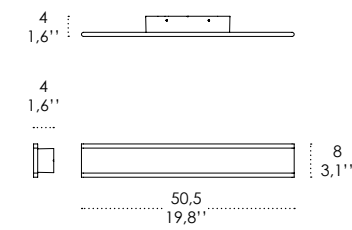

| LED DIMMER 3000K CRI≥90 220-240V | | | | | | | CE |
|------------------------------------|----------------|-----------|------------|-------------|------------|------------|--------|
| COD. | FINISHES | WATT | TOTAL W | Lm LED | Lm LAMP | BEAM ANGLE | DIMMER |
| LD0108 | B3 - G3 | 2 x 7,2 W | 2 x 9,5 W | 2 x 795 lm | 2 x 420 lm | 120° | TRIAC |
| LD0109 | B3 - G3 | 2 x 11 W | 2 x 13,5 W | 2 x 1190 lm | 2 x 630 lm | 120° | TRIAC |

STOLA

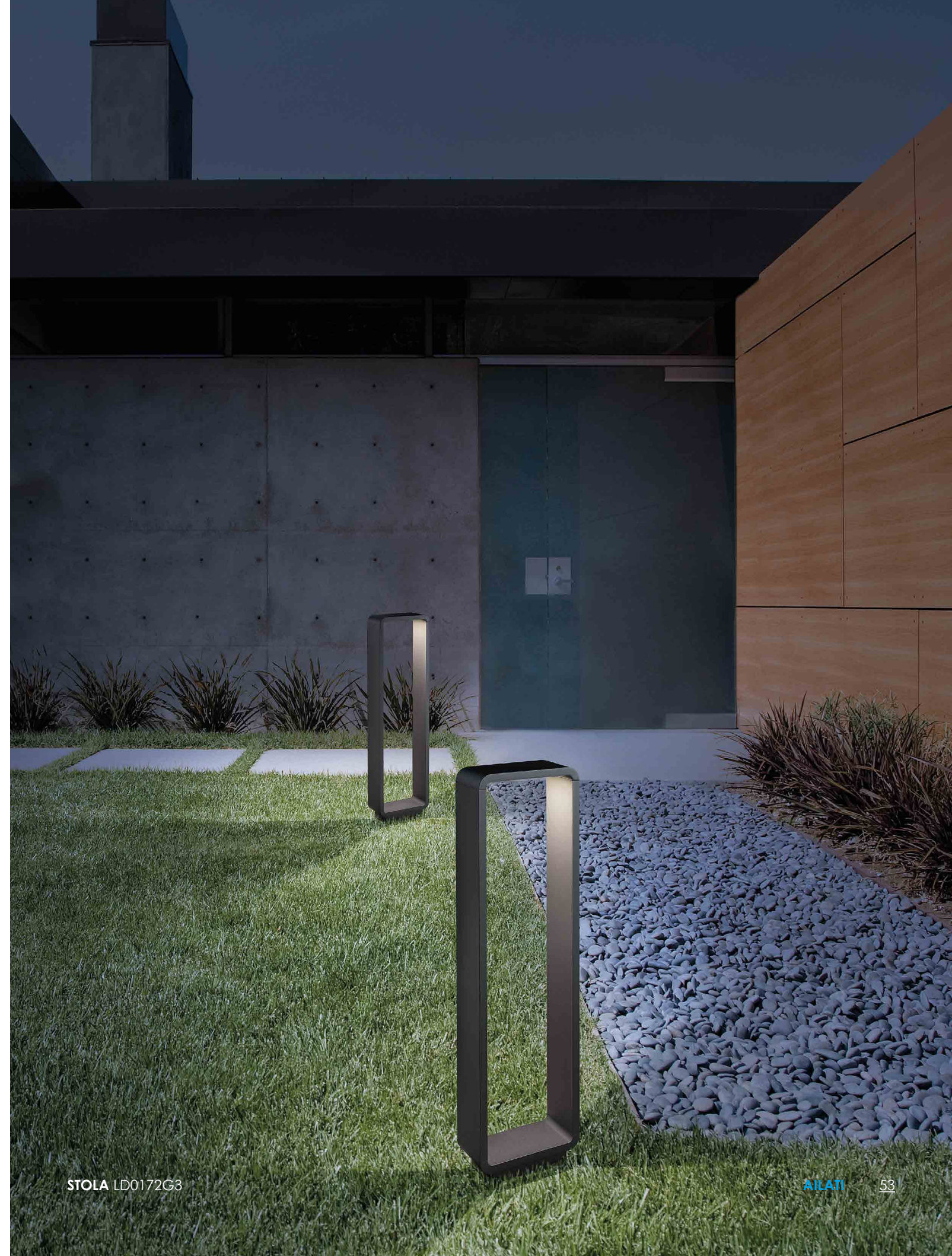



STOLA



Lampade da parete-soffitto e da terra con struttura in pressofusione di alluminio verniciato bianco opaco, grigio scuro o corten, e diffusore in policarbonato. L'elevato grado di protezione (IP54 e IP65) rende il prodotto adatto all'uso esterno ed interno.

Wall-ceiling and floor lamps with a matt white, dark grey or corten painted die-cast aluminium frame and a polycarbonate diffuser. The high IP rating (IP54 and IP65) makes the lamps ideal for indoor and outdoor use.



Parete-soffitto / Wall-ceiling

LD0170 LED

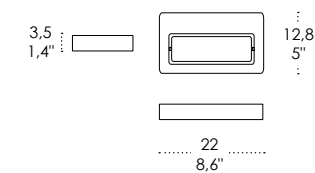

| LED 3000K CRI>80 220-240V IP54 | | | | | | CE |
|------------------------------------------------------------------|----------|------|---------|---------|---------|------------|
| COD. | FINISHES | WATT | TOTAL W | Lm LED | Lm LAMP | BEAM ANGLE |
| LD0170 | B3 - G3 | 11 W | 11 W | 1375 lm | 630 lm | 95° |

Terra / Floor

LD0172 LED

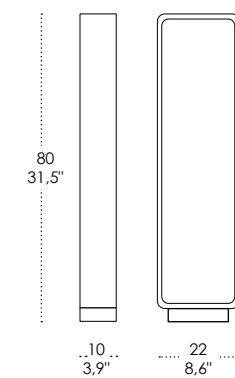

| LED 3000K CRI>80 220-240V IP65 | | | | | | CE |
|------------------------------------------------------------------|----------|------|---------|--------|---------|------------|
| COD. | FINISHES | WATT | TOTAL W | Lm LED | Lm LAMP | BEAM ANGLE |
| LD0172 | G3 - R3 | 10 W | 11 W | 650 lm | 650 lm | 50° |



Metodo di fissaggio corretto:

Lampada fissata su un plinto in cemento con viti di fissaggio idonee.

Correct fixing procedure:

Lamp fixed to a cement plinth with suitable anchor bolts or screws.

Modalità di installazioni differenti da quelle illustrate sono da ritenersi non idonee. Installation procedures other than those illustrated are considered unsuitable.

SOLE



LL0129R3

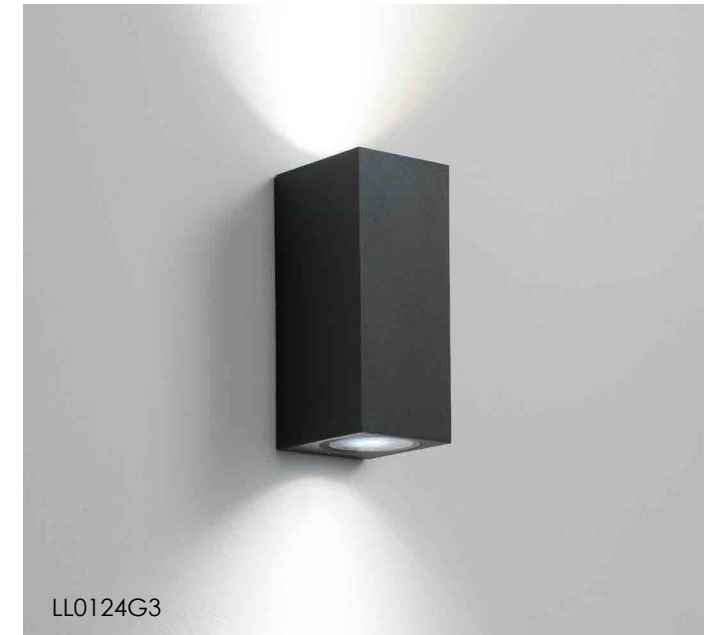

LL0124G3



B3
Bianco
White

G3
Grigio scuro
Dark grey

R3
Corten

Lampade da parete e da soffitto con struttura in pressofusione di alluminio verniciato bianco opaco, grigio scuro o corten, diffusore in policarbonato trasparente.
L'elevato grado di protezione (IP54) rende il prodotto adatto all'uso esterno ed interno.

Wall and ceiling lamps with a matt white, dark grey or corten painted die-cast aluminium frame and a clear polycarbonate diffuser.
The high IP rating (IP54) makes the lamps ideal for indoor and outdoor use.

Soffitto / Ceiling

LL0129 **GU10**

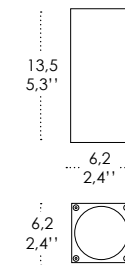

| GU10 220-240V IP54 | | | CE |
|--------------------|--------------|----------|----|
| COD. | FINISHES | WATT MAX | |
| LL0129 | G3 - B3 - R3 | 15 W | |

Lampadina non inclusa / Bulb not included

Parete / Wall

LL0122 **GU10**

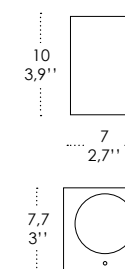

LL0124 **GU10**

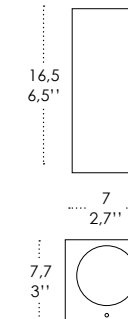

| GU10 220-240V IP54 | | | CE |
|--------------------|--------------|----------|----|
| COD. | FINISHES | WATT MAX | |
| LL0122 | G3 - B3 - R3 | 15 W | |
| LL0124 | G3 - B3 - R3 | 2 x 15 W | |

Lampadina non inclusa / Bulb not included



SOLE LD0127B3

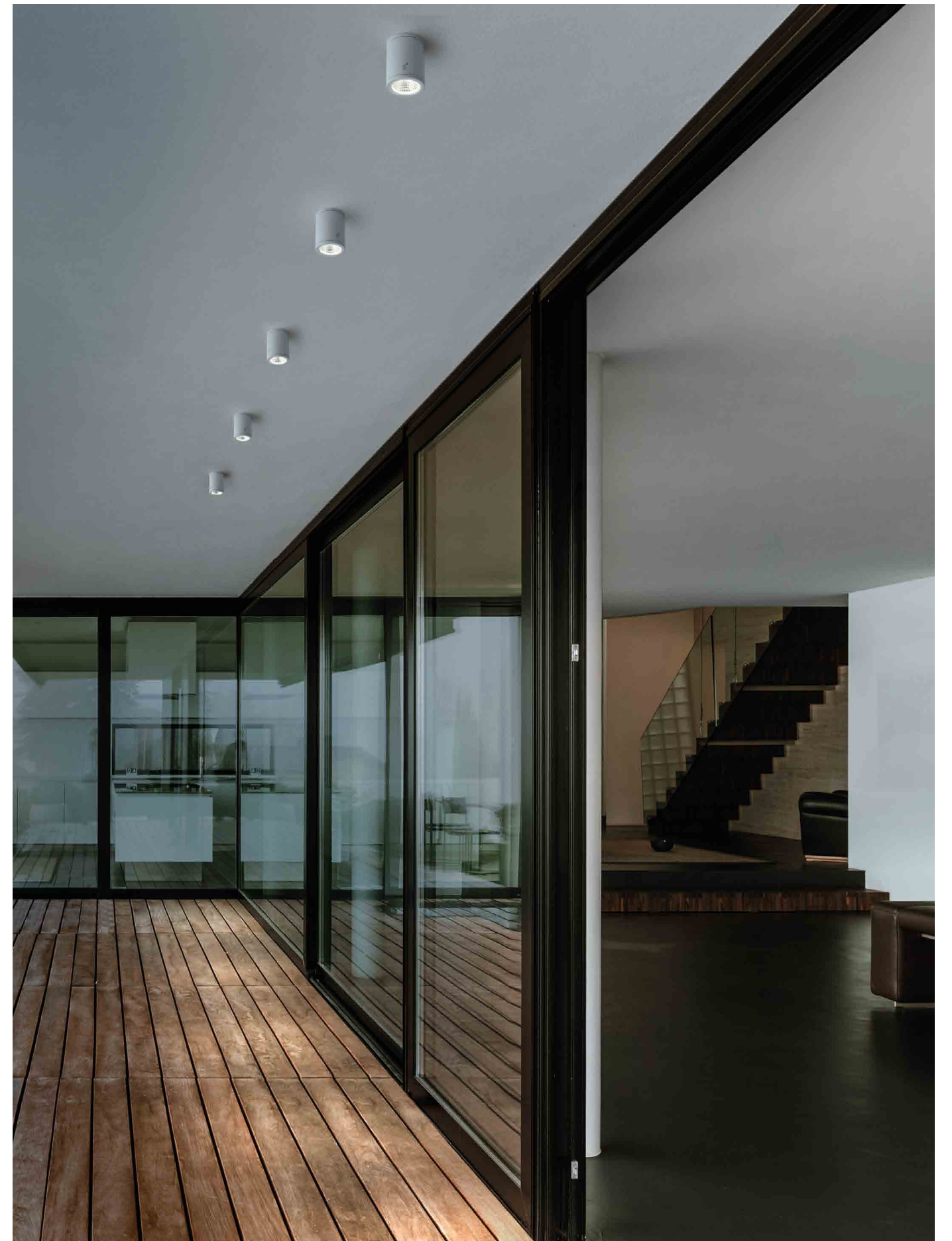

SOLE LD0120B3

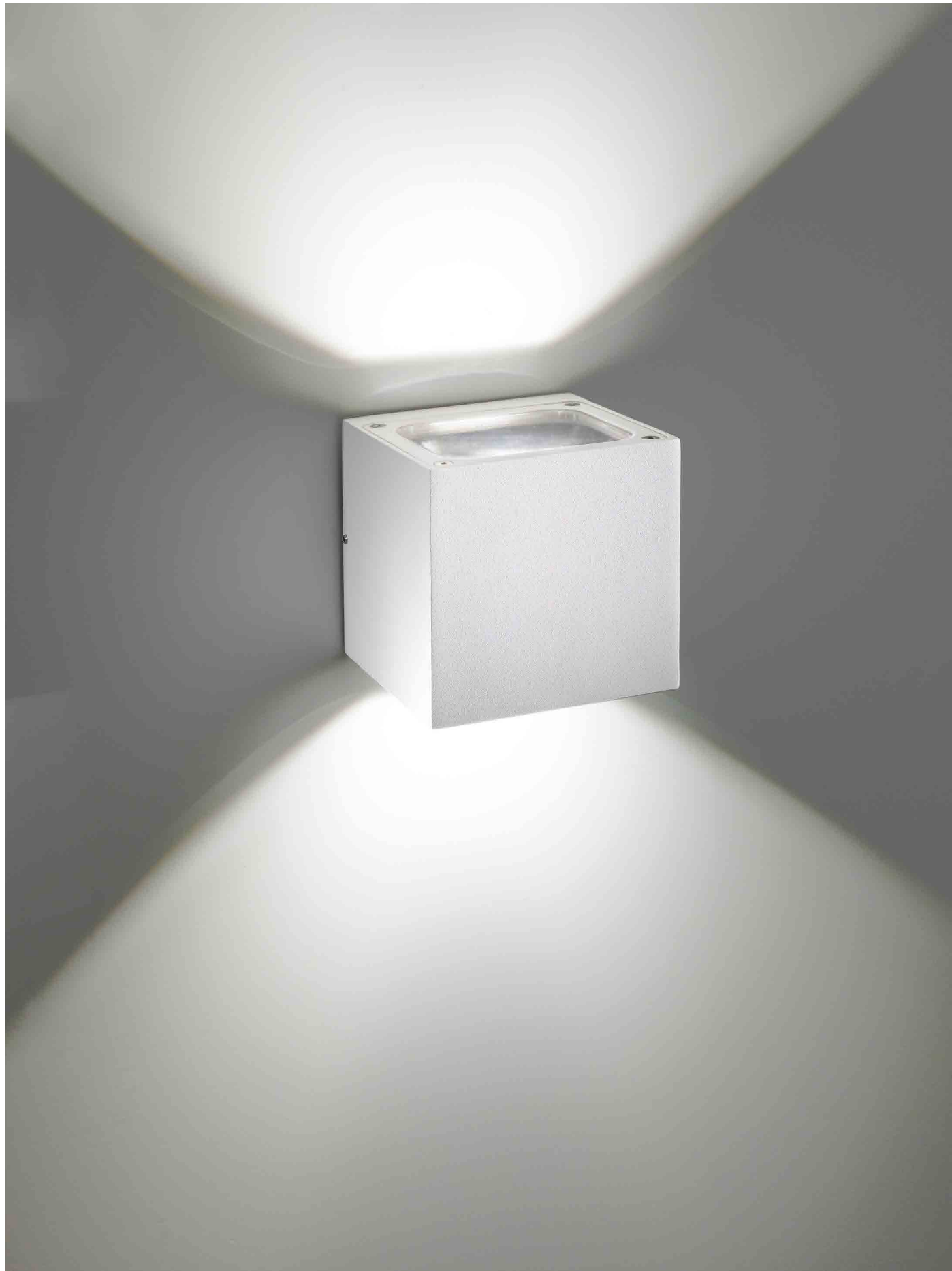

LD0125G3



LD0120G3

Soffitto / Ceiling

LD0120 **LED**

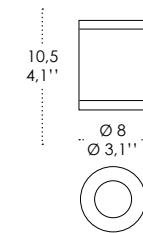

LD0125 **LED**

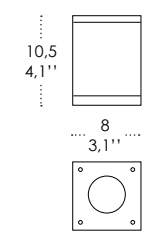

| LED 3000K CRI>80 220-240V IP54  CE | | | | | | |
|----------------------------------------------------------------------------------------------------------------------------------------------------------|----------|------|---------|--------|---------|------------|
| COD. | FINISHES | WATT | TOTAL W | Lm LED | Lm LAMP | BEAM ANGLE |
| LD0120 | G3 - B3 | 5 W | 6 W | 450 lm | 170 lm | 55° |
| LD0125 | G3 - B3 | 5 W | 6 W | 450 lm | 170 lm | 55° |

Parete / Wall

LD0127 **LED**

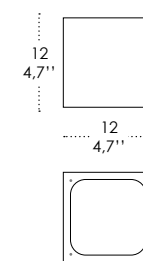

| LED 3000K CRI>80 220-240V IP54  CE | | | | | | |
|------------------------------------------------------------------------------------------------------------------------------------------------------------|----------|---------|---------|---------|---------|------------|
| COD. | FINISHES | WATT | TOTAL W | Lm LED | Lm LAMP | BEAM ANGLE |
| LD0127 | G3 - B3 | 2x9,5 W | 2x10 W | 2 x 900 | 2 x 720 | 80° |

BIANCA





BIANCA



B3
Bianco
White



G3
Grigio scuro
Dark grey

Lampada da parete con struttura in pressofusione di alluminio verniciato bianco opaco o grigio scuro e diffusore in policarbonato bianco satinato. L'elevato grado di protezione (IP54) rende il prodotto adatto all'uso esterno ed interno.

Wall lamp with a matt white or dark grey painted die-cast aluminium frame and a satin-finish white polycarbonate diffuser. The high IP rating (IP54) makes the lamp ideal for indoor and outdoor use.

Parete / Wall

LD0180 LED

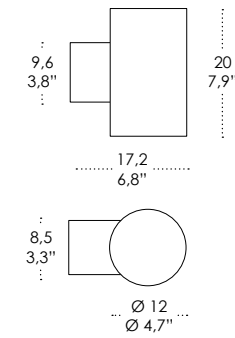

| LED 3000K CRI>80 220-240V IP54 CE | | | | | | |
|----------------------------------------------------------------------|----------------|------|---------|---------|---------|------------|
| COD. | FINISHES | WATT | TOTAL W | Lm LED | Lm LAMP | BEAM ANGLE |
| LD0180 | B3 - G3 | 9 W | 11,5 W | 1170 lm | 932 lm | 240° |

SOTTOSOPRA



LD0275G3



Lampada da parete con struttura in alluminio verniciato bianco opaco o grigio scuro, diffusore in policarbonato opalino satinato. L'elevato grado di protezione (IP54) rende il prodotto adatto all'uso esterno ed interno.

Wall lamp with a matt white or dark grey painted aluminium frame, a satin-finish opaline polycarbonate diffuser. The high IP rating (IP54) makes the lamp ideal for indoor and outdoor use.

Parete / Wall

LD0275 LED

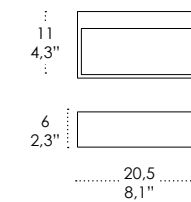

| LED 3000K CRI>80 220-240V IP54 | | | | | | CE |
|--------------------------------|----------|---------|---------|------------|------------|------------|
| COD. | FINISHES | WATT | TOTAL W | Lm LED | Lm LAMP | BEAM ANGLE |
| LD0275 | B3 - G3 | 2x4,5 W | 2 x 5 W | 2 x 400 lm | 2 x 300 lm | 110° |

BOTTOM

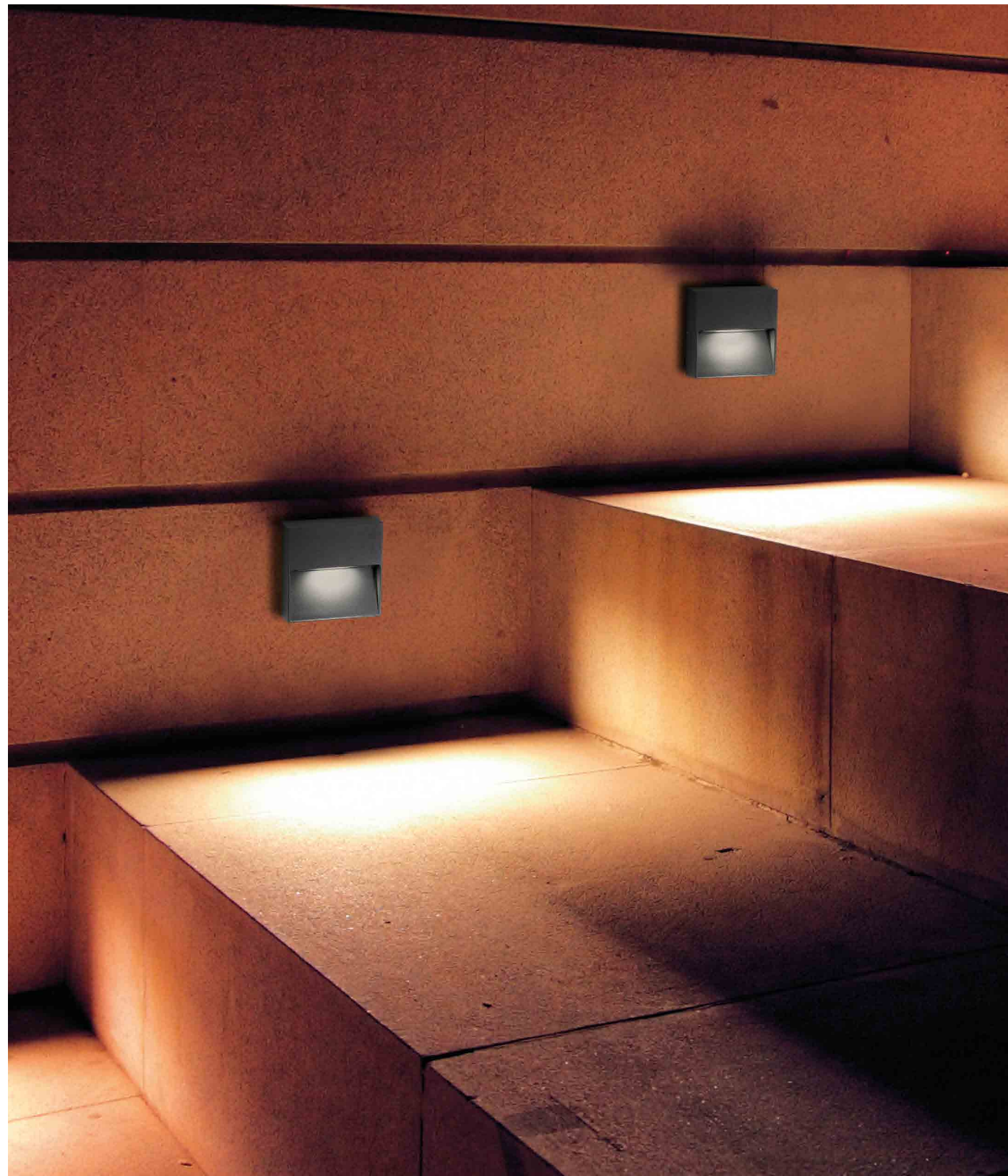

B3
Bianco
White



G3
Grigio scuro
Dark grey

Lampade da parete con struttura in pressofusione di alluminio verniciato bianco opaco o grigio scuro, diffusore in policarbonato satinato. L'elevato grado di protezione (IP54) rende il prodotto adatto all'uso esterno ed interno.

Wall lamps with a matt white or dark grey painted die-cast aluminium frame and a satin finish polycarbonate diffuser. The high IP rating (IP54) makes the lamps ideal for indoor and outdoor use.

Parete / Wall

LD0230 LED

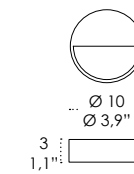

| LED 3000K CRI>80 220-240V IP54 CE | | | | | | |
|----------------------------------------------------------------------|----------|------|---------|--------|---------|------------|
| COD. | FINISHES | WATT | TOTAL W | Lm LED | Lm LAMP | BEAM ANGLE |
| LD0230 | B3 - G3 | 3 W | 4,5 W | 300 lm | 145 lm | 55° |

LD0231 LED

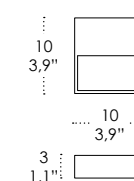

| LED 3000K CRI>80 220-240V IP54 CE | | | | | | |
|----------------------------------------------------------------------|----------|------|---------|--------|---------|------------|
| COD. | FINISHES | WATT | TOTAL W | Lm LED | Lm LAMP | BEAM ANGLE |
| LD0231 | B3 - G3 | 3 W | 4,5 W | 300 lm | 145 lm | 65° |

LD0232 LED

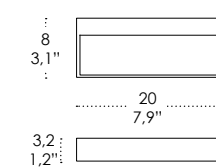

| LED 3000K CRI>80 220-240V IP54 CE | | | | | | |
|----------------------------------------------------------------------|----------|------|---------|--------|---------|------------|
| COD. | FINISHES | WATT | TOTAL W | Lm LED | Lm LAMP | BEAM ANGLE |
| LD0232 | B3 - G3 | 6 W | 8,5 W | 600 lm | 335 lm | 65° |

GIRASOLE



G3
Grigio scuro
Dark grey

Lampada da terra con sommità orientabile, struttura in pressofusione di alluminio verniciato grigio scuro e diffusore in policarbonato opalino. L'elevato grado di protezione (IP54) rende il prodotto adatto all'uso esterno.

Floor lamp with adjustable head, with a dark grey painted die-cast aluminium frame and an opaline polycarbonate diffuser. The high IP rating (IP54) makes the lamp ideal for indoor and outdoor use.

Terra / Floor

LD0260 LED

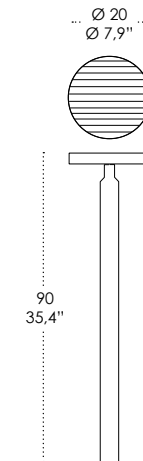
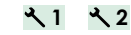

| LED 3000K CRI>80 220-240V IP54 | | | | | | |
|--------------------------------|----------|------|---------|--------|---------|------------|
| COD. | FINISHES | WATT | TOTAL W | Lm LED | Lm LAMP | BEAM ANGLE |
| LD0260 | G3 | 18 W | 18 W | 960 lm | 930 lm | 115° |

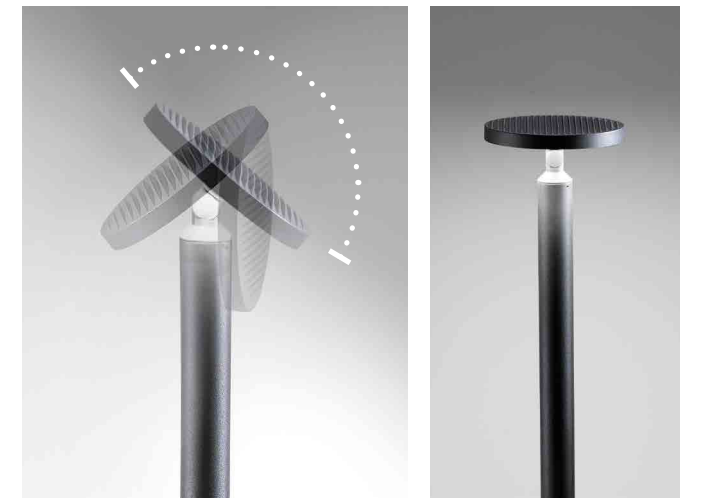

Sommità orientabile.
Adjustable lamp head.

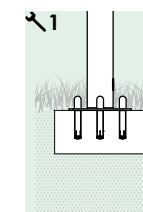

Metodo di fissaggio corretto:
Lampada fissata su un plinto in cemento con tirafondi o viti idonee.
Correct fixing procedure:
Lamp fixed to a cement plinth with suitable anchor bolts or screws.

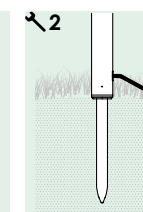

Metodo di fissaggio corretto:
Lampada fissata sul terreno con picchetto in metallo.
Correct fixing procedure:
Lamp fixed in the ground with a metal peg.

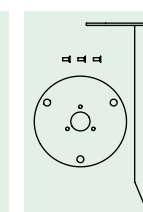

Accessori per fissaggio **INCLUSI.**
Accessories for anchoring **INCLUDED.**

Modalità di installazioni differenti da quelle illustrate sono da ritenersi non idonee.
Installation procedures other than those illustrated are considered unsuitable.

TACK



LD0240G3



Lampada da terra con struttura in pressofusione di alluminio verniciato nei colori grigio scuro o corten e diffusore in policarbonato trasparente. L'elevato grado di protezione (IP54) rende il prodotto adatto all'uso esterno.

Floor lamp with a dark grey or corten painted die-cast aluminium frame and a clear polycarbonate diffuser. The high IP rating (IP54) makes the lamp ideal for indoor and outdoor use.

Terra / Floor

LD0240 LED

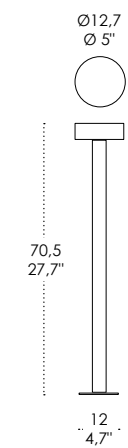

| LED 3000K CRI>80 220-240V IP54 | | | | | | CE |
|--------------------------------|----------|------|---------|--------|---------|------------|
| COD. | FINISHES | WATT | TOTAL W | Lm LED | Lm LAMP | BEAM ANGLE |
| LD0240 | G3 - R3 | 7 W | 7 W | 500 lm | 470 lm | 360° |



Metodo di fissaggio corretto:
Lampada fissata su un plinto in cemento con piastra di ancoraggio e tirafondi.
Correct fixing procedure:
Lamp fixed to a cement plinth with an anchor plate and anchor bolts.

Modalità di installazioni differenti da quelle illustrate sono da ritenersi non idonee.
Installation procedures other than those illustrated are considered unsuitable.

OVALINO





OVALINO



B3
Bianco
White



G3
Grigio scuro
Dark grey
RAL 7012

Lampada da parete con struttura in pressofusione di alluminio verniciato nei colori bianco opaco o grigio scuro e diffusore in policarbonato satinato. L'elevato grado di protezione (IP54) rende il prodotto adatto all'uso esterno ed interno.

Wall lamp with a matt white or dark grey painted die-cast aluminium frame, and a satin-finish polycarbonate diffuser. The high IP rating (IP54) makes the lamp ideal for indoor and outdoor use.

Parete / Wall

LD0030 LED

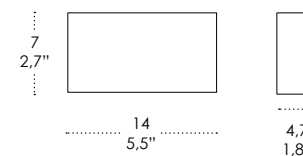

| LED 3000K CRI>80 220-240V IP54 | | | | | | CE |
|--------------------------------|----------|-----------|---------|------------|------------|------------|
| COD. | FINISHES | WATT | TOTAL W | Lm LED | Lm LAMP | BEAM ANGLE |
| LD0030 | B3 - G3 | 2 x 3,4 W | 2 x 4 W | 2 x 345 lm | 2 x 302 lm | 100° |

ASTUCCIO





ASTUCCIO



B3
Bianco
White



G3
Grigio scuro
Dark grey
RAL 7012

Lampada da parete con struttura in pressofusione di alluminio verniciato nei colori bianco opaco o grigio scuro, diffusore in policarbonato satinato. L'elevato grado di protezione (IP54) rende il prodotto adatto all'uso esterno ed interno.

Wall lamp with a matt white or dark grey painted die-cast aluminium frame and a satin-finish polycarbonate diffuser. The high IP rating (IP54) makes the lamp ideal for indoor and outdoor use.

Parete / Wall

LD0040 LED

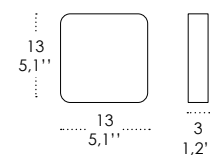

| LED 3000K CRI>80 100-240V IP54 | | | | | | CE |
|--------------------------------|----------------|---------|---------|------------|------------|------------|
| COD. | FINISHES | WATT | TOTAL W | Lm LED | Lm LAMP | BEAM ANGLE |
| LD0040 | B3 - G3 | 2x4,5 W | 2 x 5 W | 2 x 404 lm | 2 x 290 lm | 100° |

CUBETTO

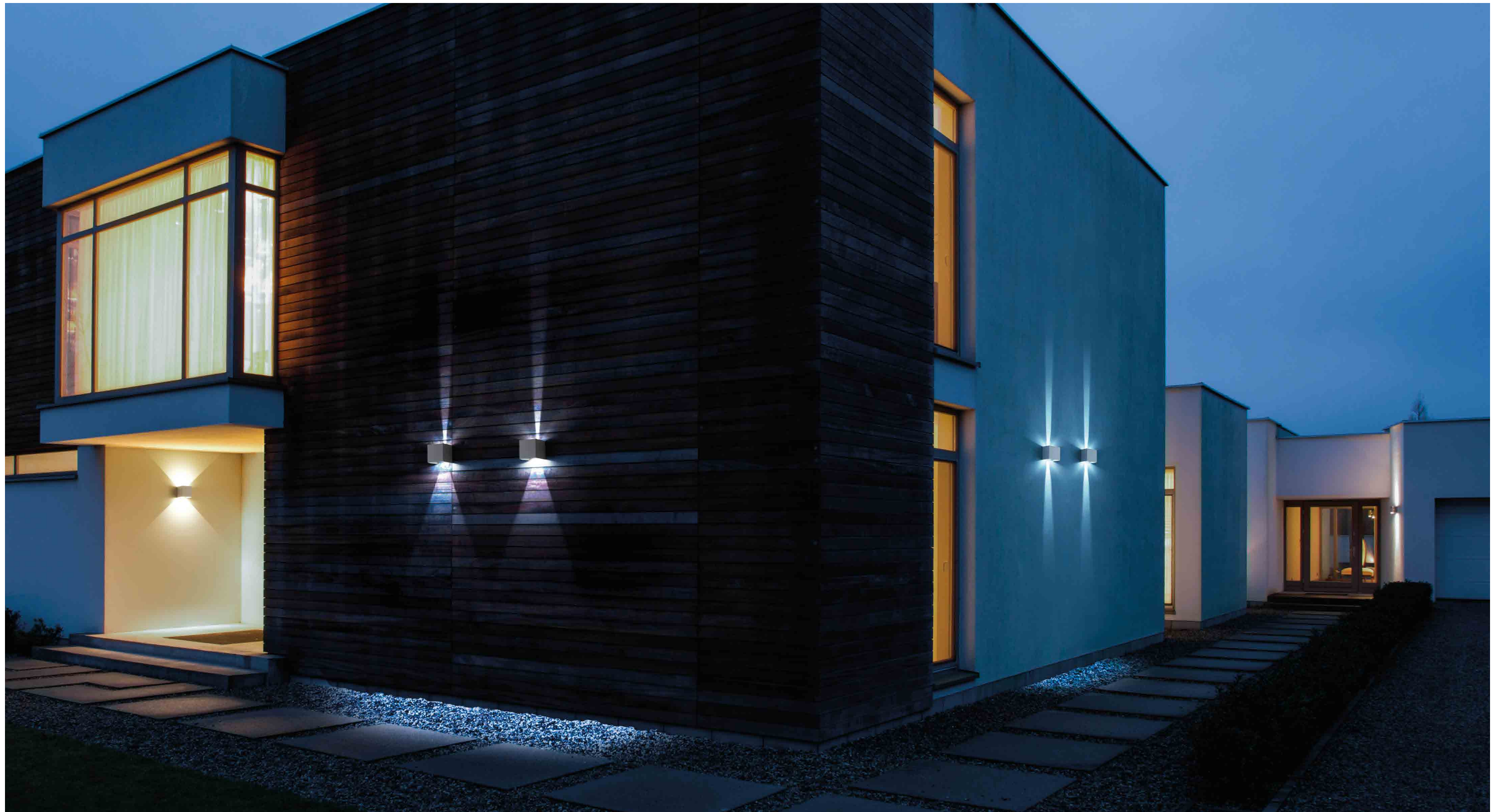

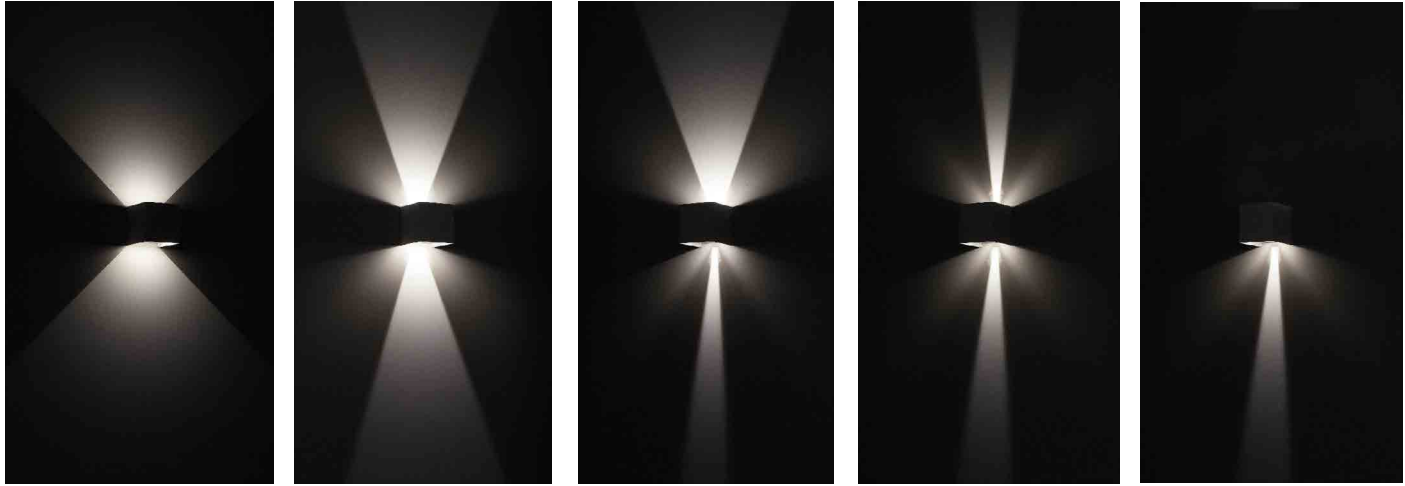

CUBETTO



Lampada da parete con struttura in pressofusione di alluminio verniciato nei colori bianco opaco o grigio scuro e diffusore in policarbonato trasparente.
L'elevato grado di protezione (IP54) rende il prodotto adatto all'uso esterno ed interno.
Provvista di regolazione meccanica indipendente del fascio luminoso sia sopra che sotto; cover personalizzabile con colori a richiesta.

Wall lamp with a matt white or dark grey painted die-cast aluminium frame and a transparent polycarbonate diffuser.
The high IP rating (IP54) makes the lamp ideal for indoor and outdoor use.
It has independent control of the beam of light above and below; the colour of the cover can be customised on request.

Parete / Wall

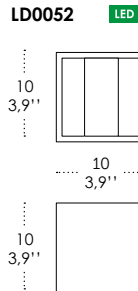

| LED 3000K CRI≥90 220-240V IP54 | | | | | | CE |
|----------------------------------------------------------------------------------------------------------------------------------------------------------------------|----------------|-------|---------|--------|---------|------------|
| COD. | FINISHES | WATT | TOTAL W | Lm LED | Lm LAMP | BEAM ANGLE |
| LD0052 | B3 - G3 | 5,4 W | 6,5 W | 594 lm | 474 lm | 60° |

AI LIGHTS
LATTI

INDOOR

Collezioni di lampade
per uso interno.

Collection of lamps
for indoor use.

STRIPE

DESIGN_ Federico de Majo



STRIPE LD0079B3



STRIPE LD0378B3



STRIPE LD0378B3

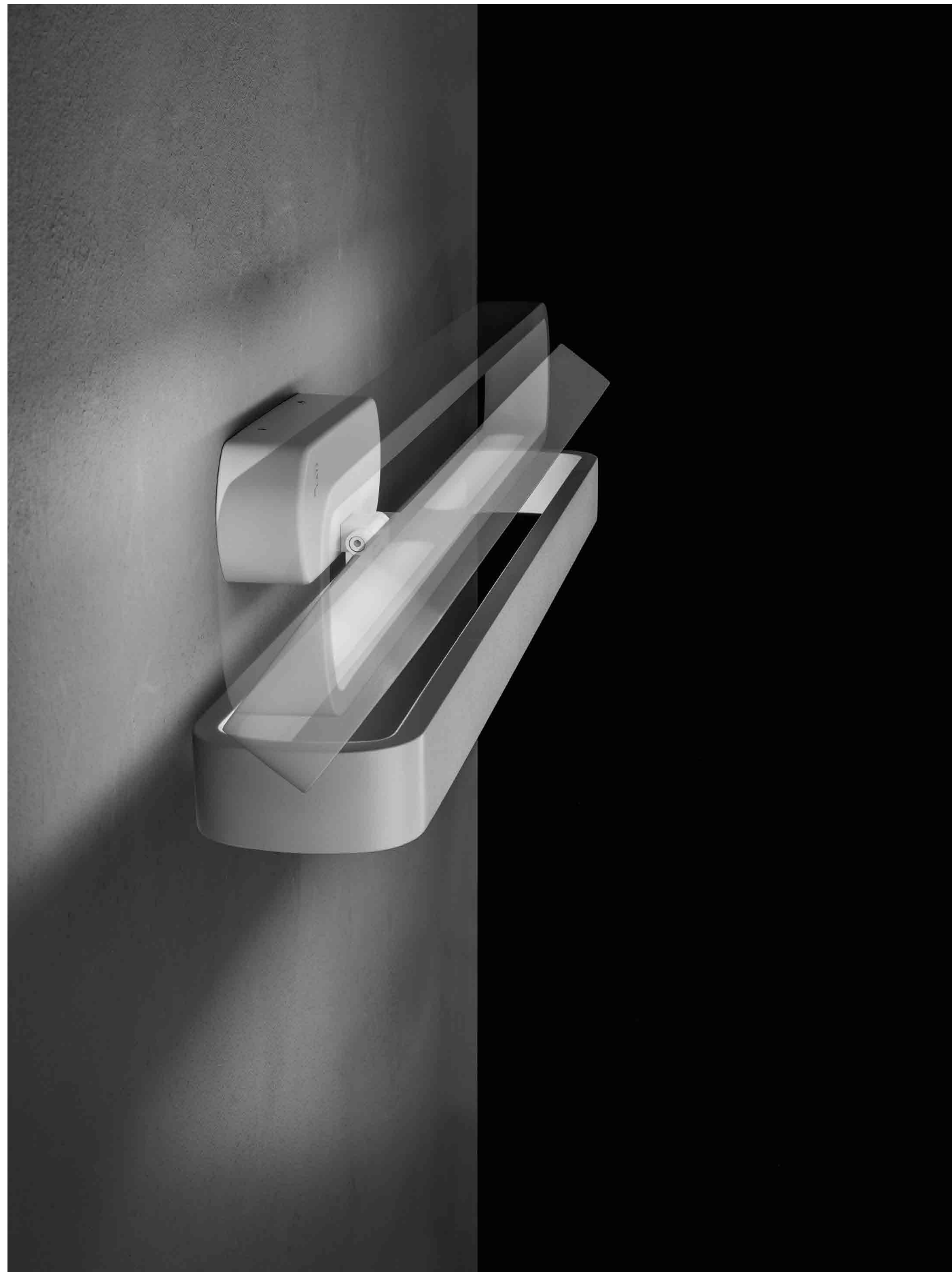

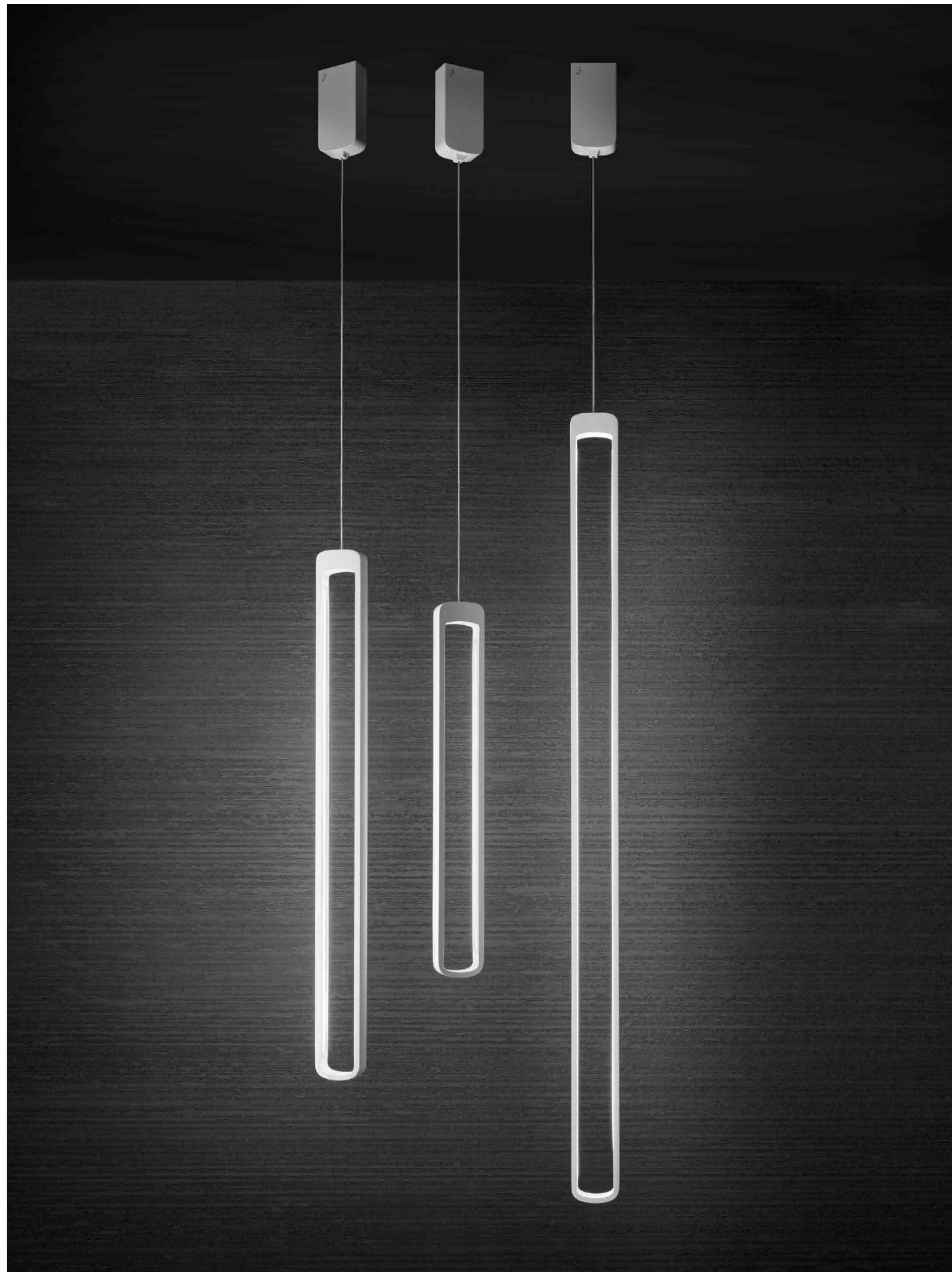

STRIPE LD0374B3 LD0373B3 LD0375B3



STRIPE LD0371B3

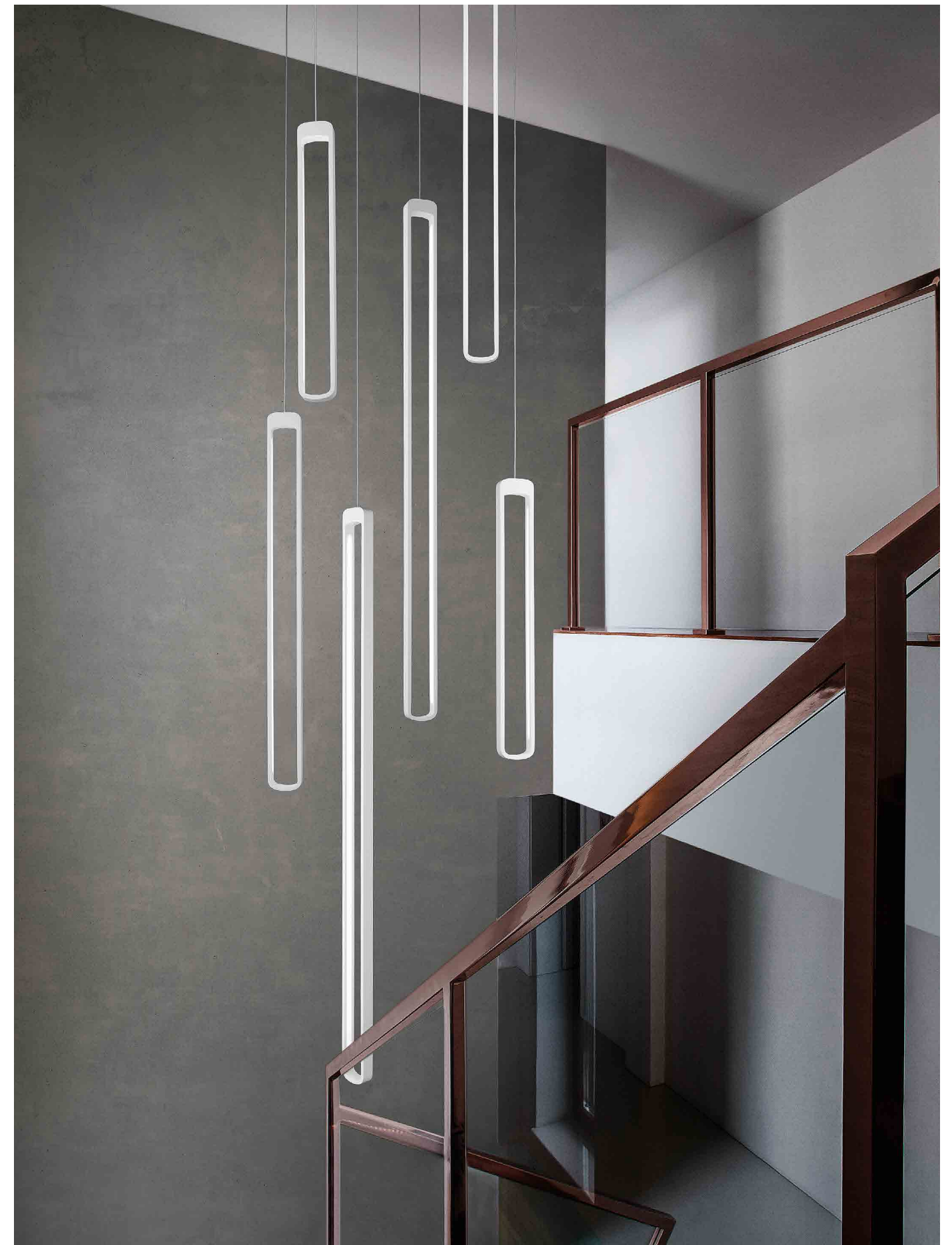

STRIPE



B3
Bianco
White

Lampade da parete, a sospensione e da terra con struttura in pressofusione di alluminio verniciato bianco opaco o sabbia e diffusore in policarbonato opalino satinato.

La collezione Stripe Magneto ha un particolare sistema di fissaggio del corpo lampada alla staffa di supporto, che semplifica e velocizza l'installazione.

Il prodotto è adatto esclusivamente all'uso interno.

Wall, suspension and floor lamps with a matt white or sand painted die-cast aluminium frame, and a satin-finish opaline polycarbonate diffuser.

The Stripe Magneto collection has a special system for fixing the lamp fixture to the support bracket, that simplifies and speeds up the installation.

The product is suitable for indoor use only.

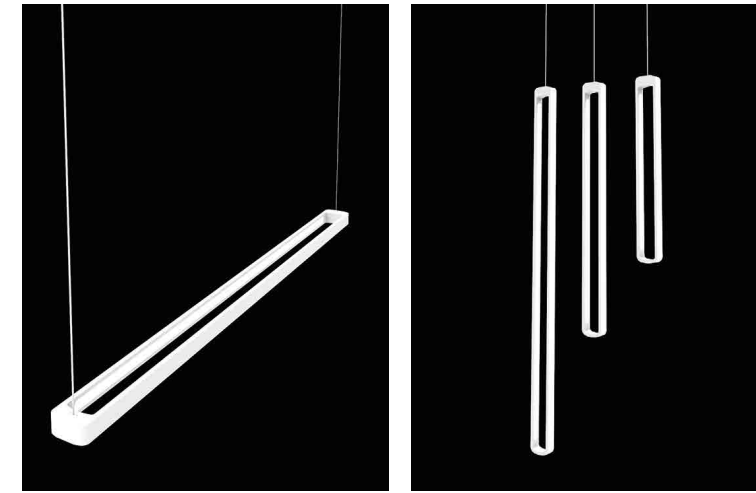

Sospensione / Suspension

LD0370 LED DIMMER

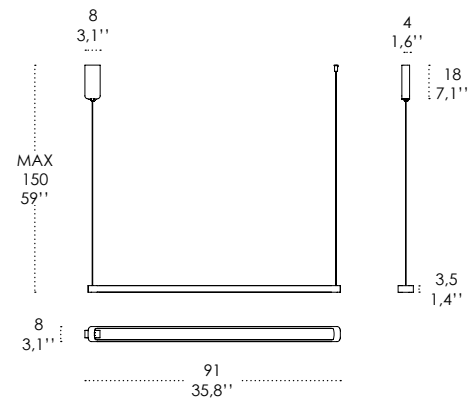

| LED DIMMER 3000K CRI≥90 200-240V IP20 | | | | | | | | CE |
|---------------------------------------|-----------|------|---------|---------|---------|------------|--------|----|
| COD. | FINISHES | WATT | TOTAL W | Lm LED | Lm LAMP | BEAM ANGLE | DIMMER | |
| LD0370 | B3 | 23 W | 25 W | 2580 lm | 1800 lm | 115° | TRIAC | |
| LD0371 | B3 | 35 W | 39 W | 3920 lm | 2750 lm | 115° | TRIAC | |

LD0371 LED DIMMER

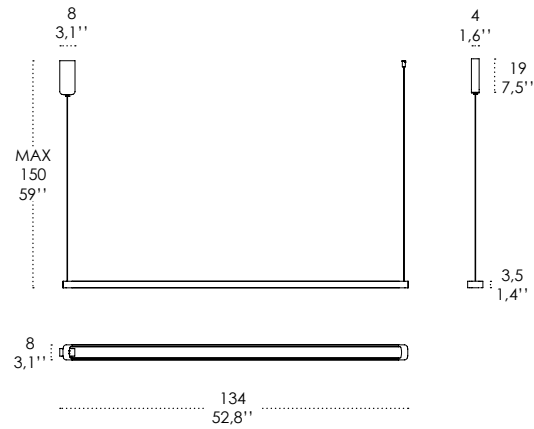

Sospensione / Suspension

LD0373 LED DIMMER

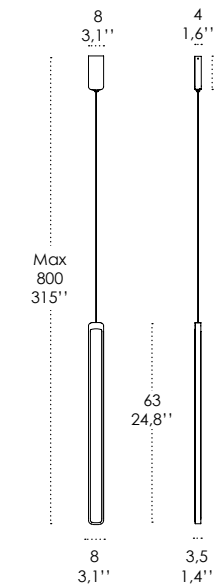

LD0374 LED DIMMER

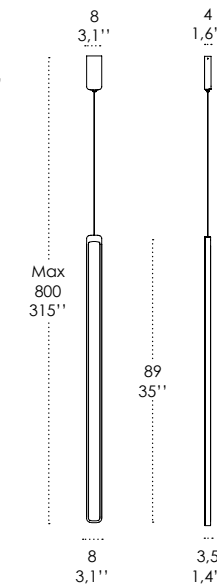

| LED DIMMER 3000K CRI≥90 200-240V IP20 | | | | | | | | CE |
|---------------------------------------|-----------|------|---------|---------|---------|------------|--------|----|
| COD. | FINISHES | WATT | TOTAL W | Lm LED | Lm LAMP | BEAM ANGLE | DIMMER | |
| LD0373 | B3 | 15 W | 17 W | 1720 lm | 1200 lm | 115° | TRIAC | |
| LD0374 | B3 | 23 W | 25 W | 2580 lm | 1800 lm | 115° | TRIAC | |
| LD0375 | B3 | 35 W | 39 W | 3920 lm | 2750 lm | 115° | TRIAC | |

LD0375 LED DIMMER

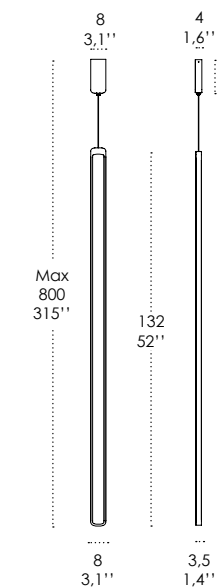

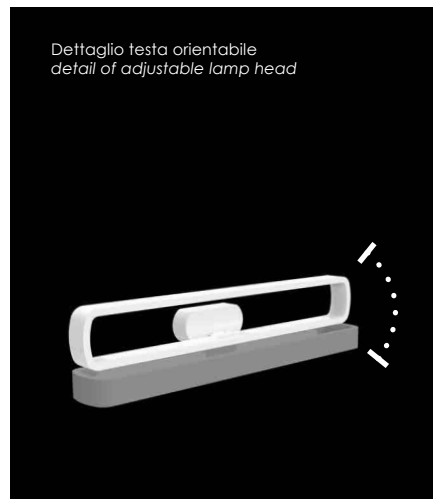

Parete / Wall

LD0377 LED DIMMER lampada regolabile / adjustable lamp

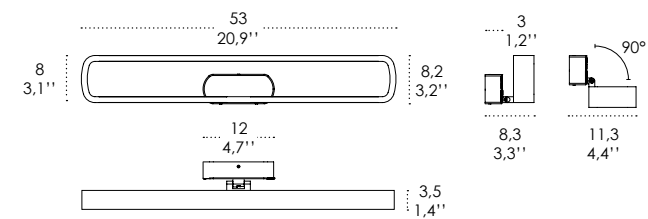

| LED DIMMER 3000K CRI≥90 200-240V IP20 | | | | | | | | CE |
|---------------------------------------|----------|------|---------|---------|---------|------------|--------|----|
| COD. | FINISHES | WATT | TOTAL W | Lm LED | Lm LAMP | BEAM ANGLE | DIMMER | |
| LD0377 | B3 | 18 W | 20 W | 2000 lm | 1400 lm | 115° | TRIAC | |
| LD0378 | B3 | 11 W | 12 W | 1230 lm | 860 lm | 110° | TRIAC | |

LD0378 LED DIMMER lampada regolabile / adjustable lamp

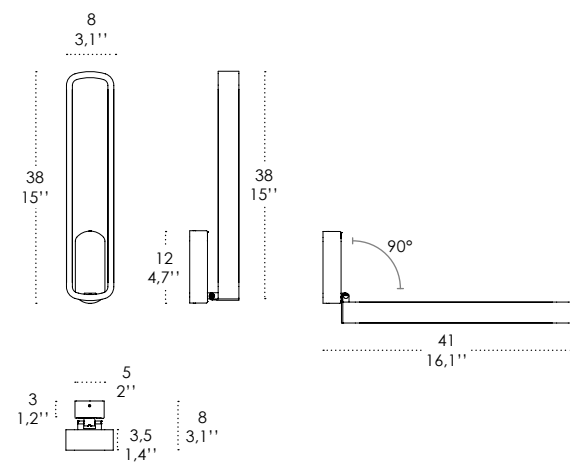

Terra / Floor

con touch dimmer / with touch dimmer

LD0079 LED DIMMER lampada regolabile / adjustable lamp

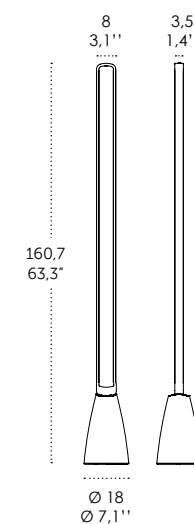

| LED DIMMER 3000K CRI≥90 100-240V IP20 | | | | | | | CE |
|---------------------------------------|----------|------|---------|---------|---------|------------|----|
| COD. | FINISHES | WATT | TOTAL W | Lm LED | Lm LAMP | BEAM ANGLE | |
| LD0079 | B3 | 35 W | 39 W | 3500 lm | 2630 lm | 240° | |



STRIPE LD0072S3



LD0071S3



Parete / Wall

LD0070 **LED**

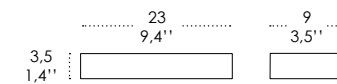

LD0071 **LED**

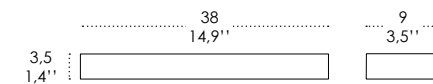

LD0072 **LED**

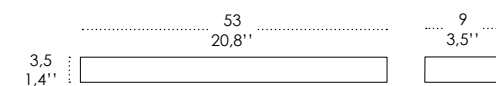

| LED 3000K CRI>90 220-240V IP20 | | | | | | CE |
|--------------------------------|----------|--------|---------|---------|---------|------------|
| COD. | FINISHES | WATT | TOTAL W | Lm LED | Lm LAMP | BEAM ANGLE |
| LD0070 | B3 - S3 | 5,5 W | 6,5 W | 700 lm | 445 lm | 100° |
| LD0071 | B3 - S3 | 12,7 W | 14 W | 1600 lm | 1045 lm | 100° |
| LD0072 | B3 - S3 | 17 W | 19 W | 2220 lm | 1325 lm | 100° |



STRIPE MAGNETO Parete-soffitto / Wall-ceiling

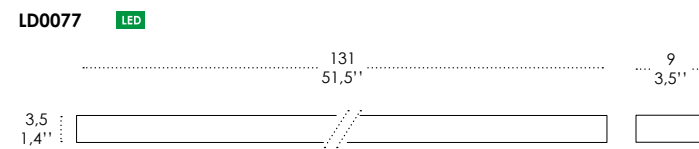
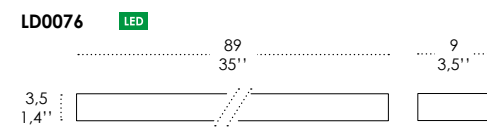

| LED 3000K CRI≥90 220-240V IP20 CE | | | | | | |
|----------------------------------------------------------------------|----------|------|---------|---------|---------|------------|
| COD. | FINISHES | WATT | TOTAL W | Lm LED | Lm LAMP | BEAM ANGLE |
| LD0076 | B3 - S3 | 27 W | 28 W | 5000 lm | 2570 lm | 100° |
| LD0077 | B3 - S3 | 34 W | 36 W | 5820 lm | 3400 lm | 100° |

RASO

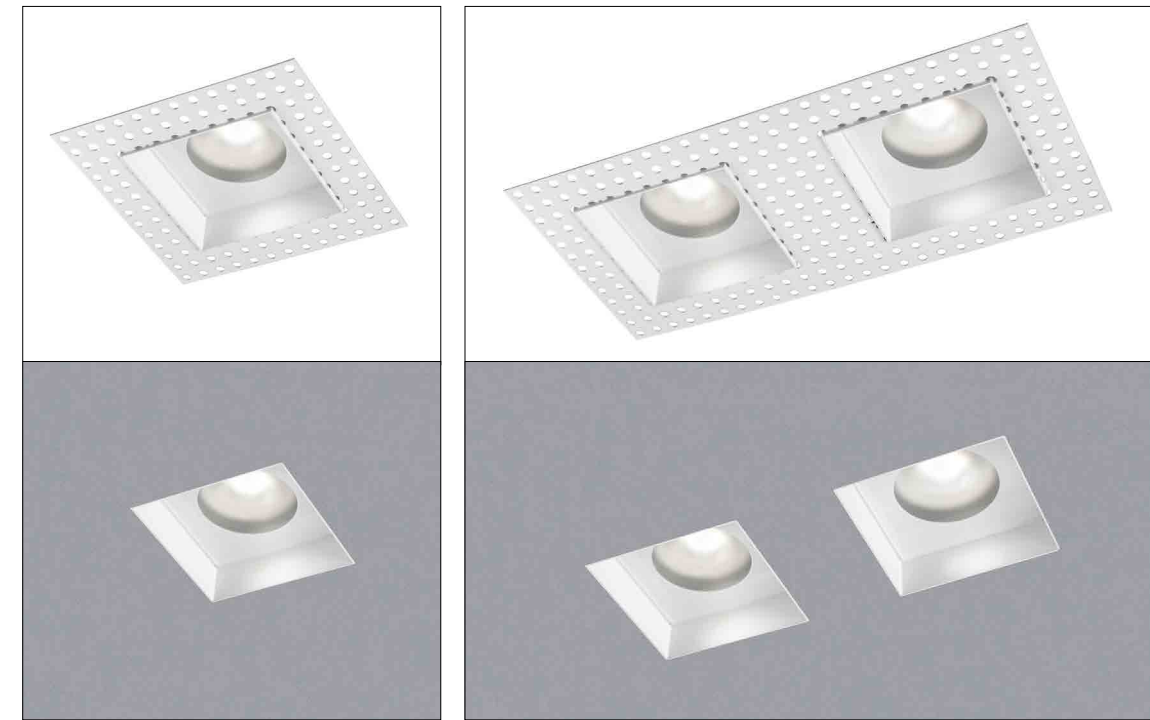
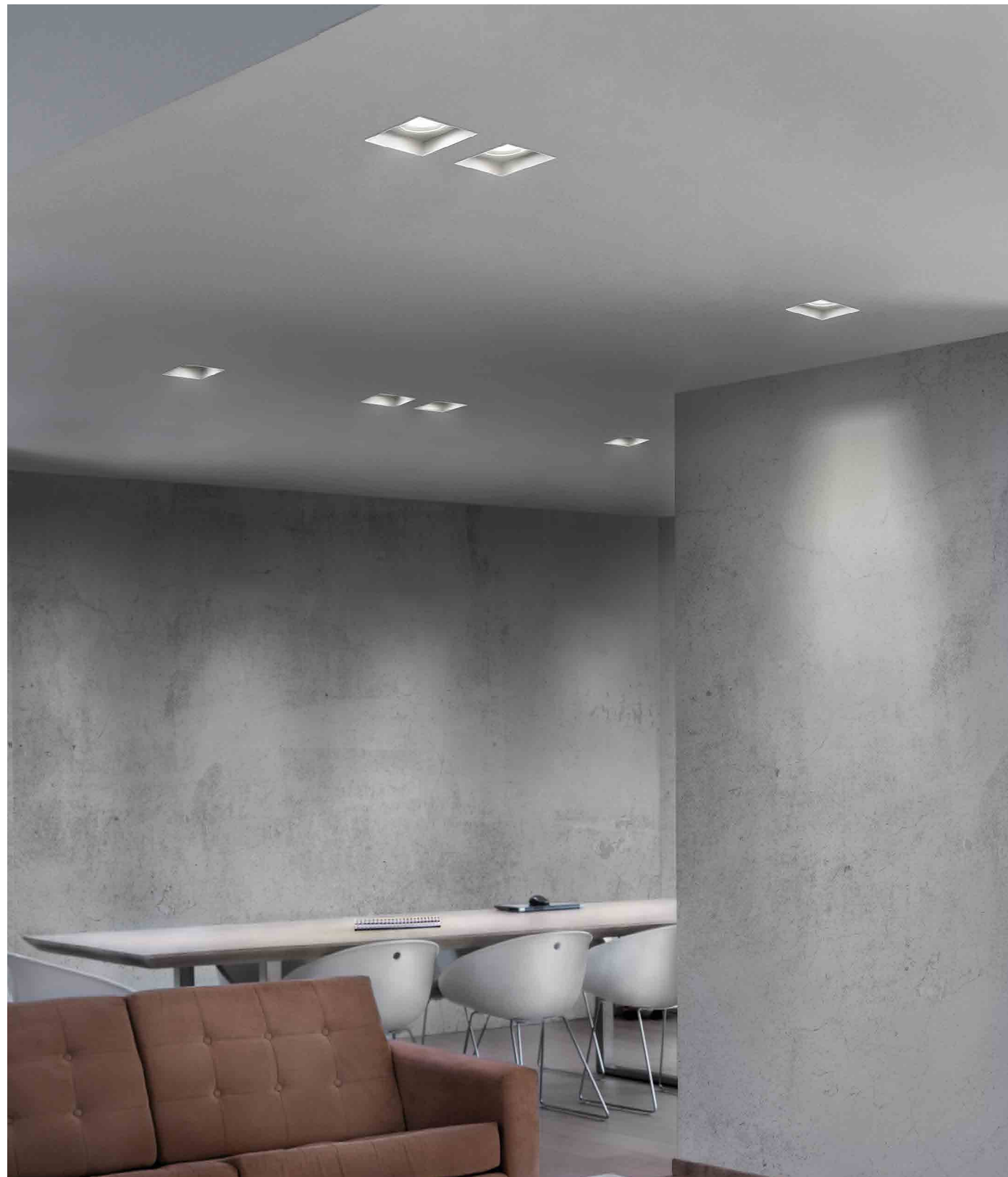

RASO



B3
Bianco
White

Faretti da incasso a scomparsa con struttura in metallo verniciato bianco opaco e diffusore in PMMA trasparente.
Il prodotto è adatto esclusivamente all'uso interno.

Built-in recessed spotlights with matt white painted metal frame and a transparent PMMA diffuser.
The product is suitable for indoor use only.

Incasso / Recessed

LL0830 **GU10**

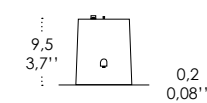

13
5,1"

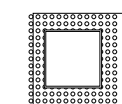

8,2
3,2"



8,5
3,3"

foro per inserimento
hole for fitting

LL0831 **GU10**

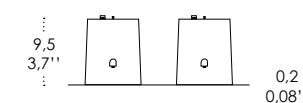

26
10,2"

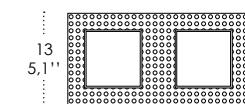

21,5
8,5"



8,5 8,5
3,3 3,3"

foro per inserimento
hole for fitting

| GU10 220-240V IP40 | | | CE |
|--------------------|----------|----------|----|
| COD. | FINISHES | WATT MAX | |
| LL0830 | B3 | 15 W | |
| LL0831 | B3 | 2 x 15 W | |

Lampadina non inclusa / Bulb not included

CONCA





CONCA



B3
Bianco
White

Lampade da incasso e da parete-soffitto con struttura in pressofusione di alluminio verniciato bianco opaco. Il prodotto è adatto esclusivamente all'uso interno.

Recessed and wall-ceiling lamps with a matt white painted die-cast aluminium frame. The product is suitable for indoor use only.

Incasso / Recessed

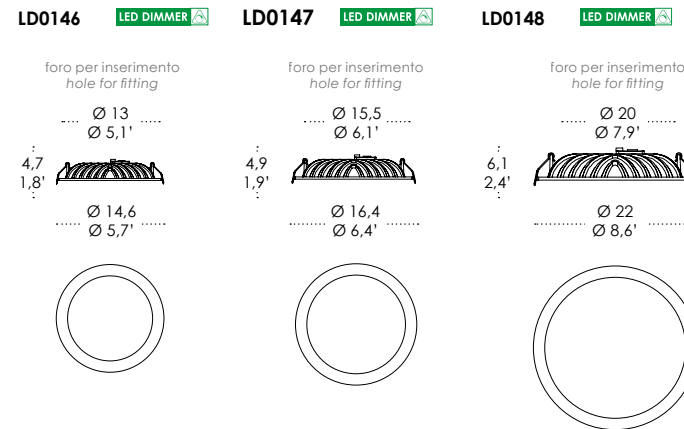

| LED DIMMER 3000K CRI>80 220-240V IP20 | | | | | CE |
|---------------------------------------|----------|---------|---------|------------|----|
| COD. | FINISHES | TOTAL W | Lm LAMP | BEAM ANGLE | |
| LD0146 | B3 | 12,8 W | 595 lm | 130° | |
| LD0147 | B3 | 19,7 W | 990 lm | 140° | |
| LD0148 | B3 | 24,5 W | 1270 lm | 150° | |

Parete-soffitto / Wall-ceiling

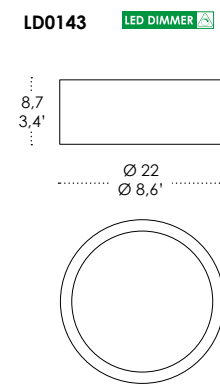
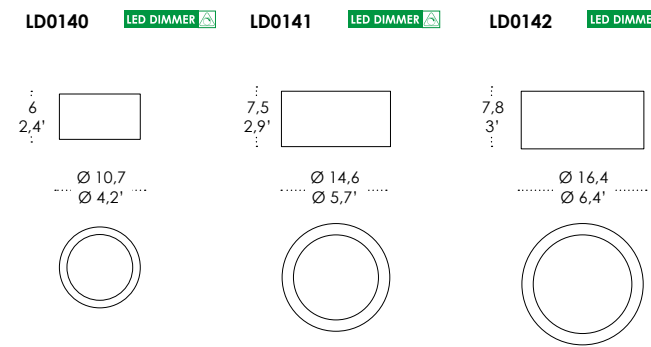

| LED DIMMER 3000K CRI>80 220-240V IP20 | | | | | | CE |
|---------------------------------------|----------|---------|---------|------------|--------|----|
| COD. | FINISHES | TOTAL W | Lm LAMP | BEAM ANGLE | DIMMER | |
| LD0140 | B3 | 8,5 W | 319 lm | 120° | TRIAC | |
| LD0141 | B3 | 12,8 W | 595 lm | 130° | TRIAC | |
| LD0142 | B3 | 19,7 W | 990 lm | 140° | TRIAC | |
| LD0143 | B3 | 24,5 W | 1270 lm | 150° | TRIAC | |



RIGA

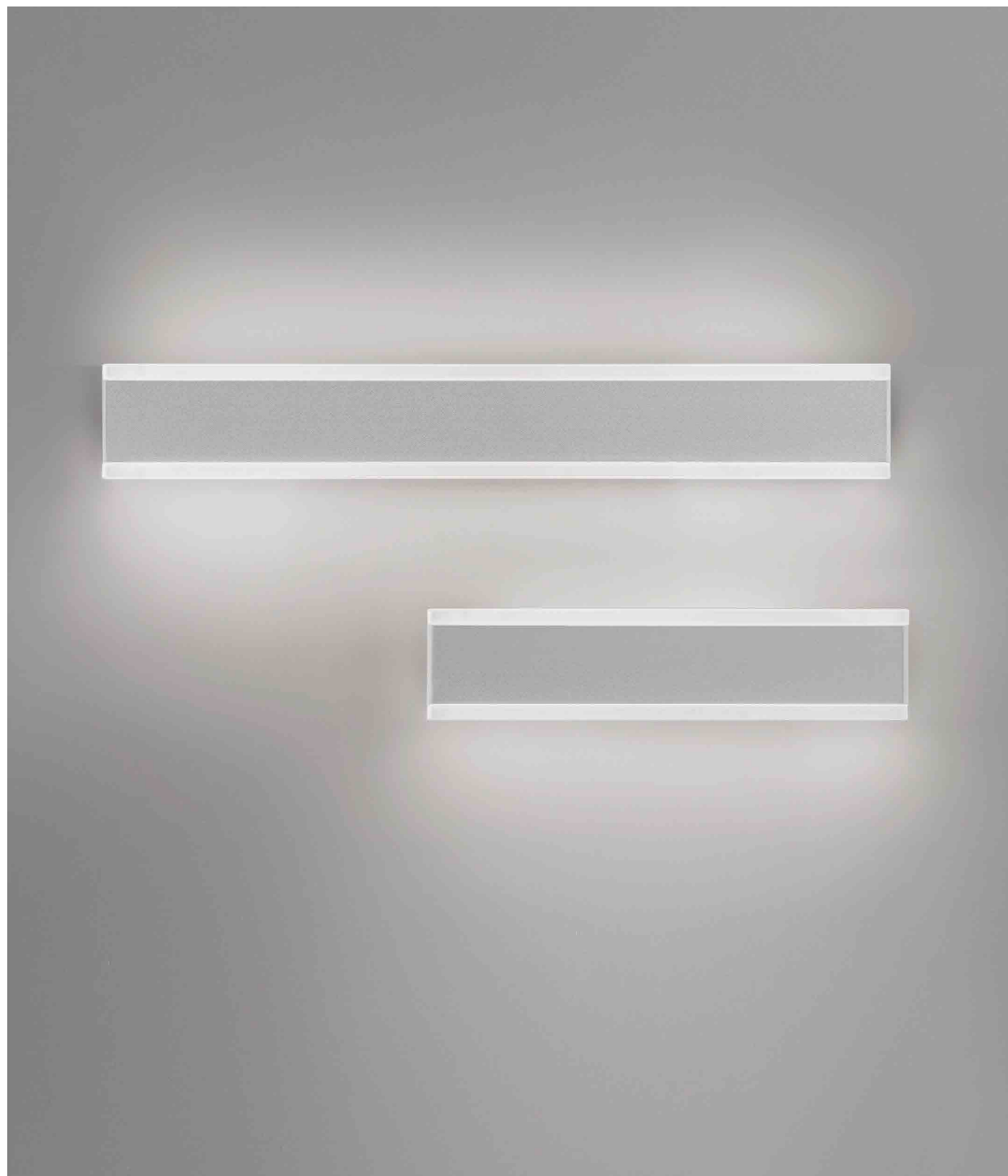



RIGA



B3
Bianco
White



G3
Grigio scuro
Dark grey

Lampade da parete-soffitto e a sospensione con struttura in alluminio verniciato nei colori bianco opaco o grigio scuro, e diffusore in polycarbonato satinato.

La lampada a sospensione è adatta esclusivamente all'uso interno; la lampada da parete-soffitto ha un grado di protezione (IP54) che la rende adatta all'uso esterno ed interno.

Wall-ceiling and suspension lamps with a matt white or dark grey painted aluminium frame and a satin-finish polycarbonate diffuser.

The suspension lamp is suitable for indoor use only; the wall-ceiling lamp has a high IP rating (IP54) that makes it ideal for indoor and outdoor use.

Sospensione / Suspension

LD0101 LED

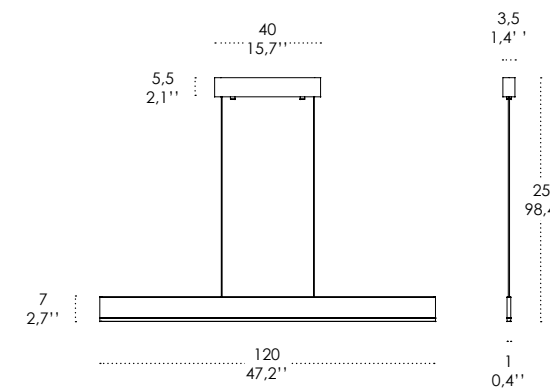

| LED 3000K CRI≥90 220-240V IP20 | | | | | | | CE |
|--------------------------------|----------|--------|---------|---------|---------|------------|----|
| COD. | FINISHES | WATT | TOTAL W | Lm LED | Lm LAMP | BEAM ANGLE | |
| LD0101 | B3 | 32,4 W | 40 W | 3564 lm | 1890 lm | 95° | |
| LD0102 | B3 | 43 W | 54 W | 4730 lm | 2510 lm | 95° | |

LD0102 LED

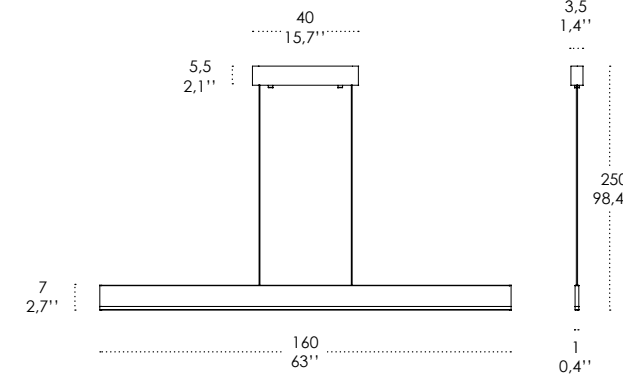

Parete-soffitto / Wall-ceiling

LD0108 LED TRIAC

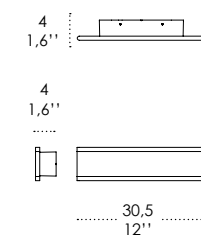

LD0109 LED TRIAC

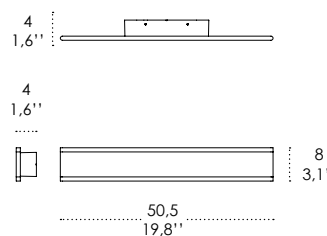

| LED DIMMER 3000K CRI≥90 220-240V IP54 | | | | | | | | CE |
|---------------------------------------|----------|-----------|------------|-------------|------------|------------|--------|----|
| COD. | FINISHES | WATT | TOTAL W | Lm LED | Lm LAMP | BEAM ANGLE | DIMMER | |
| LD0108 | B3 - G3 | 2 x 7,2 W | 2 x 9,5 W | 2 x 795 lm | 2 x 420 lm | 120° | TRIAC | |
| LD0109 | B3 - G3 | 2 x 11 W | 2 x 13,5 W | 2 x 1190 lm | 2 x 630 lm | 120° | TRIAC | |

ECLIPSE TONDA



ECLIPSE TONDA



B3
Bianco
White

Lampade da incasso e da soffitto, con struttura in pressofusione di alluminio verniciato bianco opaco e diffusore in policarbonato satinato. Eclipse combina due sorgenti con differenti effetti luminosi, comandate da un unico driver controllabile tramite interruttore standard per la versione a 3 step. Disponibile anche la versione "full light" on off.
Il prodotto è adatto esclusivamente all'uso interno.

Recessed and ceiling lamps with a matt white painted die-cast aluminium frame and a satin-finish polycarbonate diffuser. Eclipse combines two light sources, with different lighting effects, with one driver, controlled by a standard switch (per the 3-steps version). Also available in the "full light" on off version. The product is suitable for indoor use only.

La lampada è controllata da un unico interruttore, con ogni ciclo di accensione ravvicinato cambia tipologia di illuminazione.
STEP 1 (SMD) - STEP 2 (COB) - STEP 3 (SMD + COB)
Lasciando la lampada spenta per un tempo prolungato alla sua riaccensione parte sempre dallo STEP 1.

The lamp is controlled by a single switch, the type of illumination changes with each ignition cycle.
STEP 1 (SMD) - STEP 2 (COB) - STEP 3 (SMD + COB)
Leaving the lamp off, for a longer period, to its restart always starts from STEP 1.

Incasso / Recessed



Soffitto / Ceiling



LD0001 LED 3 STEP
LD0002 (on-off) LED

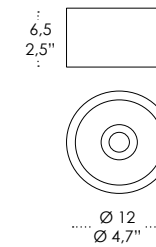

LD0003 LED 3 STEP
LD0005 (on-off) LED

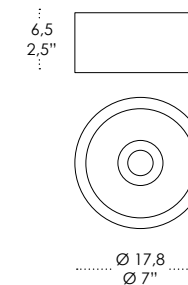

| LED 3 STEP 3000K CRI>80 100-240V IP20 | | | | | |
|---------------------------------------|----------|--------------------|----------------|---------------------|------------|
| COD. | FINISHES | WATT | TOTAL W | Lm LAMP | BEAM ANGLE |
| LD0001 | B3 | 6,8 W + 6,8 W | 7 W + 7 W | 170 lm + 600 lm | 100° |
| LD0003 | B3 | 13,6 W + 13,6 W | 14 W + 14 W | 460 lm + 1050 lm | 100° |

| LED versione/version on-off 3000K CRI>80 100-240V IP20 | | | | | |
|--------------------------------------------------------|----------|--------|---------|---------|------------|
| COD. | FINISHES | WATT | TOTAL W | Lm LAMP | BEAM ANGLE |
| LD0002 | B3 | 13,6 W | 14 W | 770 lm | 100° |
| LD0005 | B3 | 27,2 W | 28 W | 1500 lm | 100° |

LD0010 LED 3 STEP
LD0016 (on-off) LED

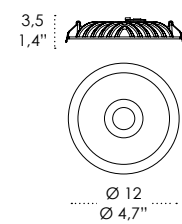

LD0012 LED 3 STEP
LD0017 (on-off) LED

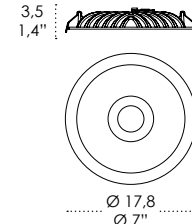

| LED 3 STEP 3000K CRI>80 100-240V IP20 | | | | | | |
|---------------------------------------|----------|--------------------|----------------|---------------------|------------------|------------|
| COD. | FINISHES | WATT | TOTAL W | Lm LAMP | HOLE FOR FITTING | BEAM ANGLE |
| LD0010 | B3 | 6,8 W + 6,8 W | 7 W + 7 W | 170 lm + 600 lm | Ø 11 - Ø 4,3" | 100° |
| LD0012 | B3 | 13,6 W + 13,6 W | 14 W + 14 W | 460 lm + 1050 lm | Ø 16 - Ø 6,3" | 100° |

| LED versione/version on-off 3000K CRI>80 100-240V IP20 | | | | | | |
|--------------------------------------------------------|----------|--------|---------|---------|------------------|------------|
| COD. | FINISHES | WATT | TOTAL W | Lm LAMP | HOLE FOR FITTING | BEAM ANGLE |
| LD0016 | B3 | 13,6 W | 14 W | 770 lm | Ø 11 - Ø 4,3" | 100° |
| LD0017 | B3 | 27,2 W | 28 W | 1500 lm | Ø 16 - Ø 6,3" | 100° |

ECLIPSE QUADRA

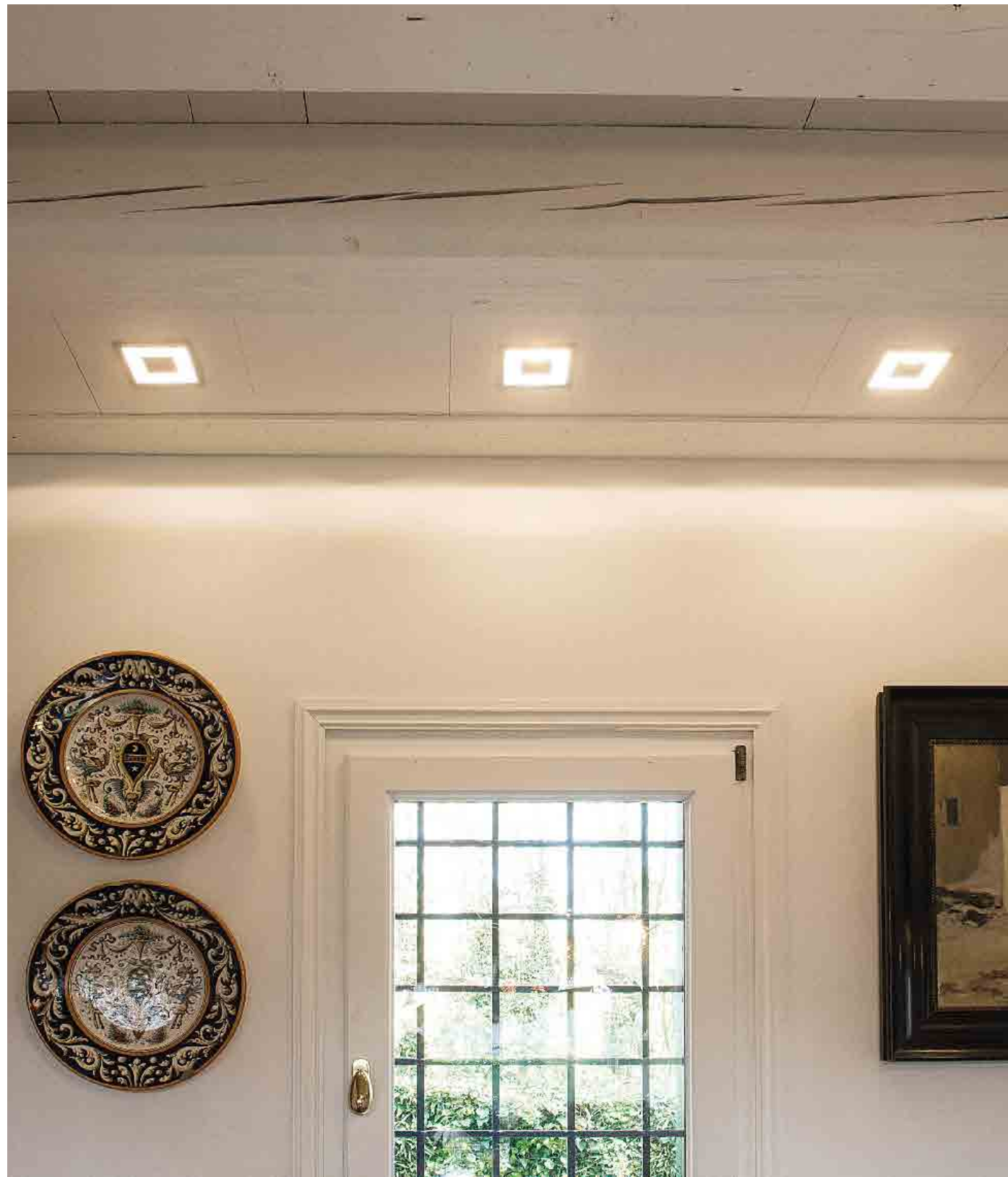

ECLIPSE QUADRA



B3
Bianco
White

Lampade da incasso e da soffitto, con struttura in pressofusione di alluminio verniciato bianco opaco e diffusore in policarbonato satinato. Eclipse combina due sorgenti con differenti effetti luminosi, comandate da un unico driver controllabile tramite interruttore standard per la versione a 3 step. Disponibile anche la versione "full light" on off. Il prodotto è adatto esclusivamente all'uso interno.

Recessed and ceiling lamps with a matt white painted die-cast aluminium frame and a satin-finish polycarbonate diffuser. Eclipse combines two light sources, with different lighting effects, with one driver, controlled by a standard switch (per the 3-steps version). Also available in the "full light" on off version. The product is suitable for indoor use only.

La lampada è controllata da un unico interruttore, con ogni ciclo di accensione ravvicinato cambia tipologia di illuminazione. **STEP 1 (SMD) - STEP 2 (COB) - STEP 3 (SMD + COB)** Lasciando la lampada spenta per un tempo prolungato alla sua riaccensione parte sempre dallo STEP 1.

The lamp is controlled by a single switch, the type of illumination changes with each ignition cycle. **STEP 1 (SMD) - STEP 2 (COB) - STEP 3 (SMD + COB)** Leaving the lamp off, for a longer period, to its restart always starts from STEP 1.

Incasso / Recessed



LD0013 **LD0018 (on-off)** **LED 3 STEP** **LED**

LD0015 **LD0019 (on-off)** **LED 3 STEP** **LED**

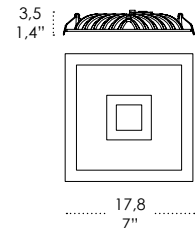
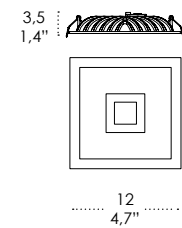

| LED 3 STEP 3000K CRI>80 100-240V IP20 | | | | | | |
|---------------------------------------|----------|-----------------|-------------|------------------|---------------------|------------|
| COD. | FINISHES | WATT | TOTAL W | Lm LAMP | HOLE FOR FITTING | BEAM ANGLE |
| LD0013 | B3 | 6,8 W + 6,8 W | 7 W + 7 W | 170 lm + 600 lm | 11 x 11 4,3 x 4,3 " | 100° |
| LD0015 | B3 | 13,6 W + 13,6 W | 14 W + 14 W | 460 lm + 1050 lm | 16 x 16 6,3 x 6,3 " | 100° |

| LED versione/version on-off 3000K CRI>80 100-240V IP20 | | | | | | |
|--------------------------------------------------------|----------|--------|---------|---------|---------------------|------------|
| COD. | FINISHES | WATT | TOTAL W | Lm LAMP | HOLE FOR FITTING | BEAM ANGLE |
| LD0018 | B3 | 13,6 W | 14 W | 770 lm | 11 x 11 4,3 x 4,3 " | 100° |
| LD0019 | B3 | 27,2 W | 28 W | 1500 lm | 16 x 16 6,3 x 6,3 " | 100° |

Soffitto / Ceiling



LD0004 **LD0007 (on-off)** **LED 3 STEP** **LED**

LD0006 **LD0008 (on-off)** **LED 3 STEP** **LED**

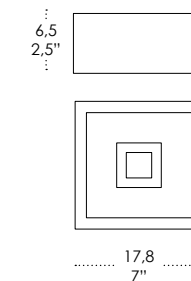
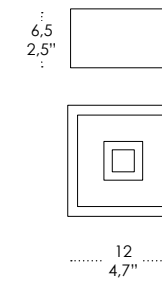

| LED 3 STEP 3000K CRI>80 100-240V IP20 | | | | | |
|---------------------------------------|----------|-----------------|-------------|------------------|------------|
| COD. | FINISHES | WATT | TOTAL W | Lm LAMP | BEAM ANGLE |
| LD0004 | B3 | 6,8 W + 6,8 W | 7 W + 7 W | 170 lm + 600 lm | 100° |
| LD0006 | B3 | 13,6 W + 13,6 W | 14 W + 14 W | 460 lm + 1050 lm | 100° |

| LED versione/version on-off 3000K CRI>80 100-240V IP20 | | | | | |
|--------------------------------------------------------|----------|--------|---------|---------|------------|
| COD. | FINISHES | WATT | TOTAL W | Lm LAMP | BEAM ANGLE |
| LD0007 | B3 | 13,6 W | 14 W | 770 lm | 100° |
| LD0008 | B3 | 27,2 W | 28 W | 1500 lm | 100° |

CUBETTO

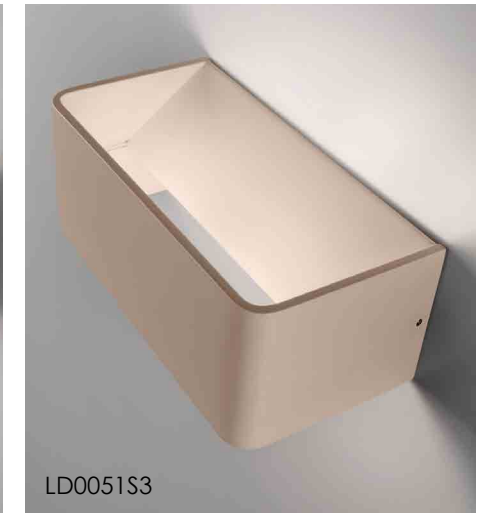

Lampade da parete con struttura in pressofusione di alluminio verniciato nei colori bianco opaco o sabbia, diffusore in policarbonato trasparente. Il prodotto è adatto esclusivamente all'uso interno.

Wall lamps with a matt white or sand painted die-cast aluminium frame and a transparent polycarbonate diffuser. The product is suitable for indoor use only.

Parete / Wall

LD0050 LED

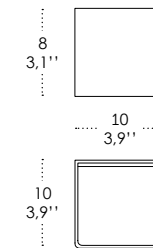

LD0051 LED

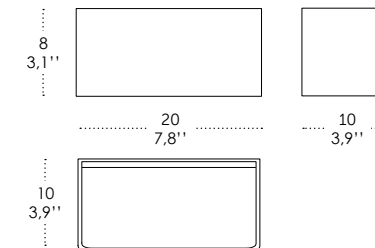

| LED 3000K - CRI≥90 - 220-240V CE IP20 CE | | | | | | |
|-------------------------------------------|----------|--------|---------|---------|---------|------------|
| COD. | FINISHES | WATT | TOTAL W | Lm LED | Lm LAMP | BEAM ANGLE |
| LD0050 | B3 - S3 | 5,4 W | 7,2 W | 594 lm | 455 lm | 60° |
| LD0051 | B3 - S3 | 10,8 W | 14,3 W | 1188 lm | 904 lm | 60° |

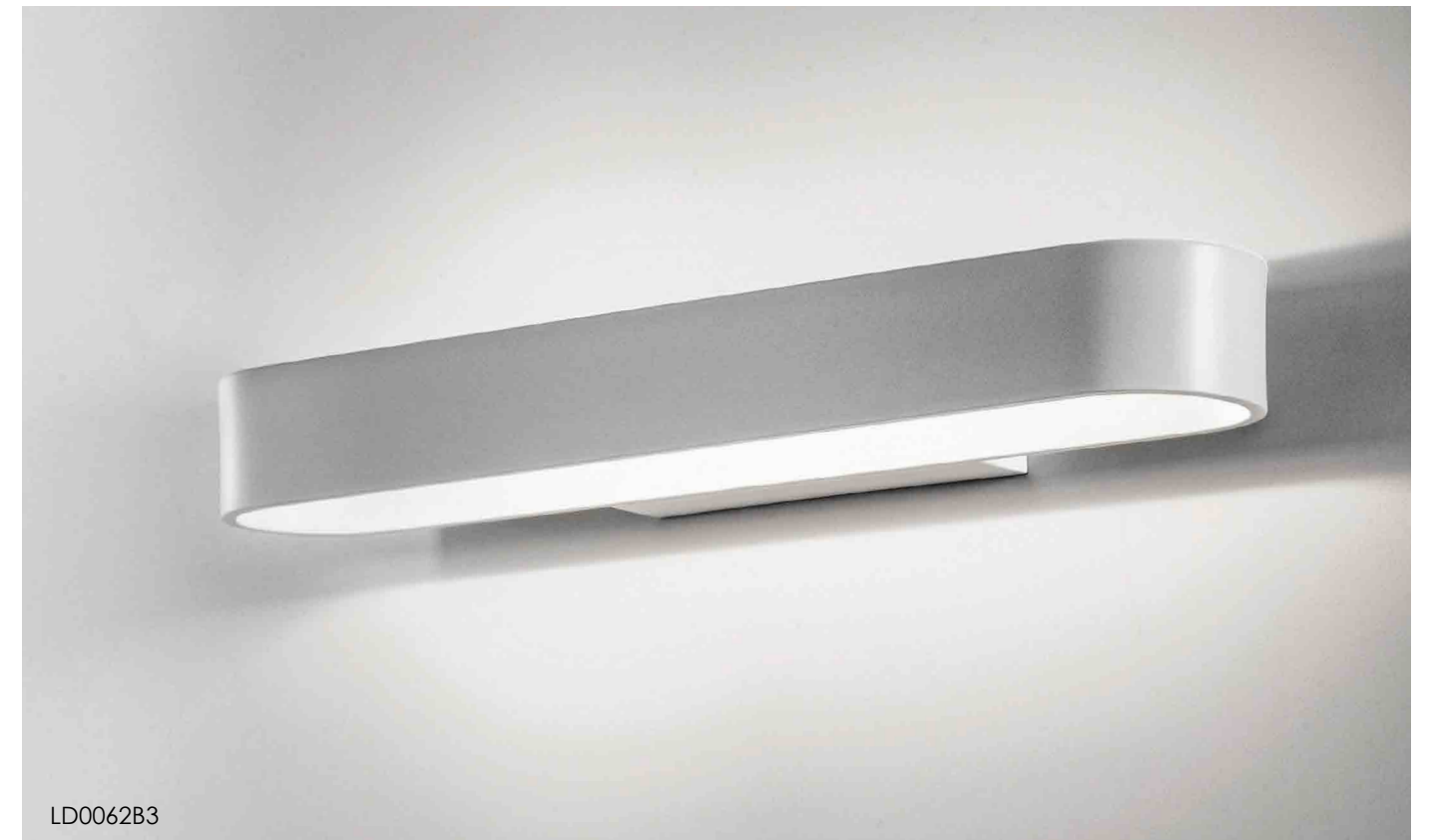

LD0062B3



B3
Bianco
White

Lampade da parete con struttura in pressofusione di alluminio verniciato bianco opaco e diffusore in policarbonato satinato.
Il prodotto è adatto esclusivamente all'uso interno.

Wall lamps with a matt white painted die-cast aluminium frame and a satin-finish polycarbonate diffuser.
The product is suitable for indoor use only.

Parete / Wall

LD0061 LED TRIAC

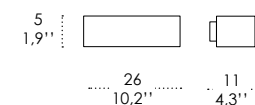

LD0062 LED TRIAC

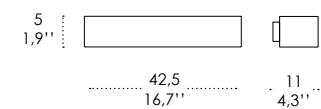

| LED DIMMER 3000K CRI≥90 220-240V IP20 | | | | | | | | CE |
|---------------------------------------|----------|------|---------|---------|---------|--------|------------|----|
| COD. | FINISHES | WATT | TOTAL W | Lm LED | Lm LAMP | DIMMER | BEAM ANGLE | |
| LD0061 | B3 | 11 W | 12,5 W | 1620 lm | 835 lm | TRIAC | 100° | |
| LD0062 | B3 | 14 W | 15,5 W | 2320 lm | 1060 lm | TRIAC | 100° | |

BRIDGE

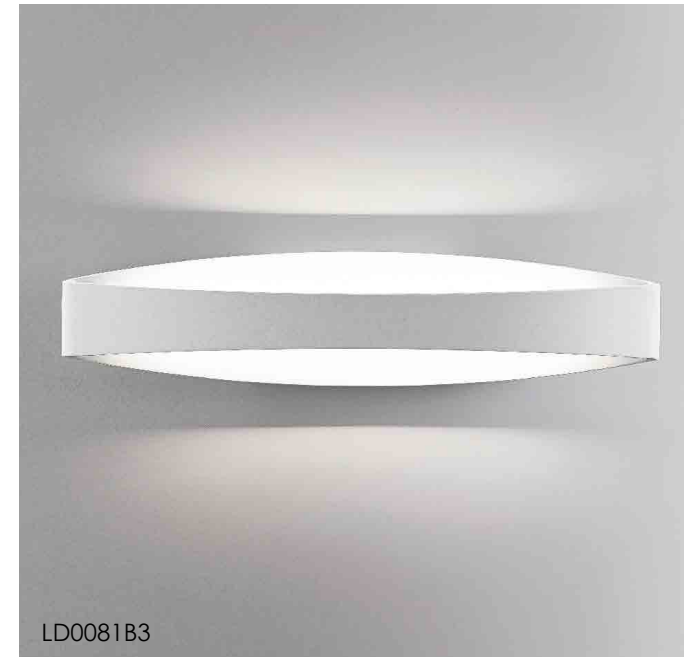

LD0081B3



LD0080B3



B3
Bianco
White

Lampade da parete con struttura in alluminio verniciato bianco opaco e diffusore in policarbonato trasparente.
Il prodotto è adatto esclusivamente all'uso interno.

Wall lamps with a matt white painted aluminium frame and a transparent polycarbonate diffuser.
The product is suitable for indoor use only.

Parete / Wall

LD0080

LED

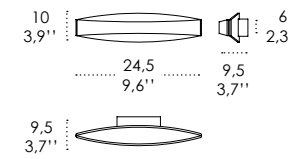

LD0081

LED

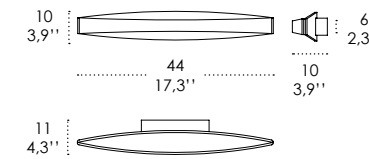

| LED 3000K CRI≥90 100-240V IP20 | | | | | | | CE |
|--------------------------------|-----------|-------|---------|--------|---------|------------|----|
| COD. | FINISHES | WATT | TOTAL W | Lm LED | Lm LAMP | BEAM ANGLE | |
| LD0080 | B3 | 5,4 W | 7,2 W | 594 lm | 456 lm | 120° | |

| LED 3000K CRI≥90 220-240V IP20 | | | | | | | CE |
|--------------------------------|-----------|--------|---------|---------|---------|------------|----|
| COD. | FINISHES | WATT | TOTAL W | Lm LED | Lm LAMP | BEAM ANGLE | |
| LD0081 | B3 | 14,4 W | 18 W | 1584 lm | 1285 lm | 60° | |

CALEIDO



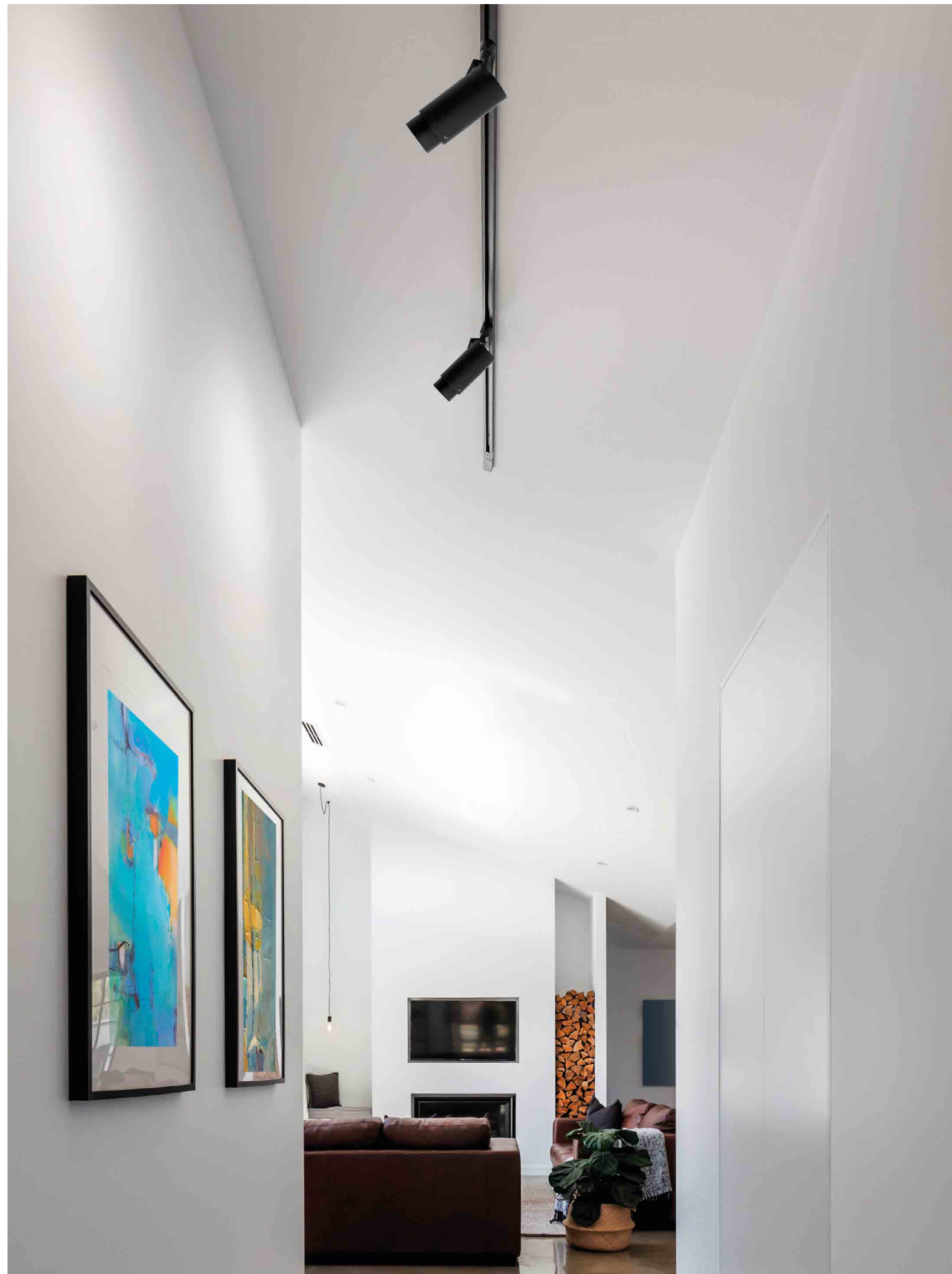

Attacco binario EU
EU track fixing

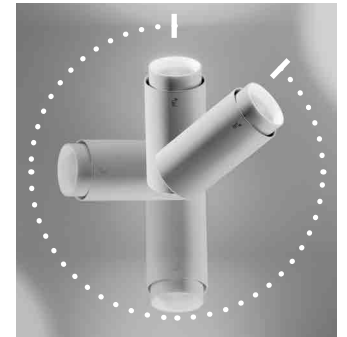
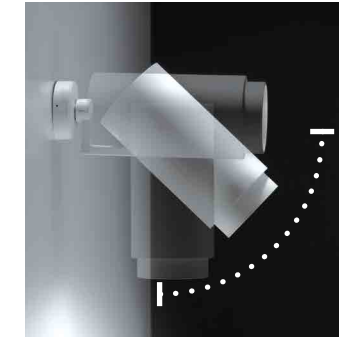

CALEIDO



B3
Bianco
White



G3
Grigio scuro
Dark grey

Lampade da parete-soffitto, a sospensione, track, con struttura in alluminio verniciato nei colori bianco opaco o grigio scuro e diffusore in policarbonato trasparente.
La collezione Caleido è caratterizzata dal particolare terminale telescopico che permette la regolazione del fascio luminoso.
Il prodotto è adatto esclusivamente all'uso interno.

Wall-ceiling, suspension and track lamps with a matt white or dark grey painted aluminium frame, and a transparent polycarbonate diffuser.
The Caleido collection features a special optical system for adjusting the light beam.
The product is suitable for indoor use only.

Sospensione / Suspension

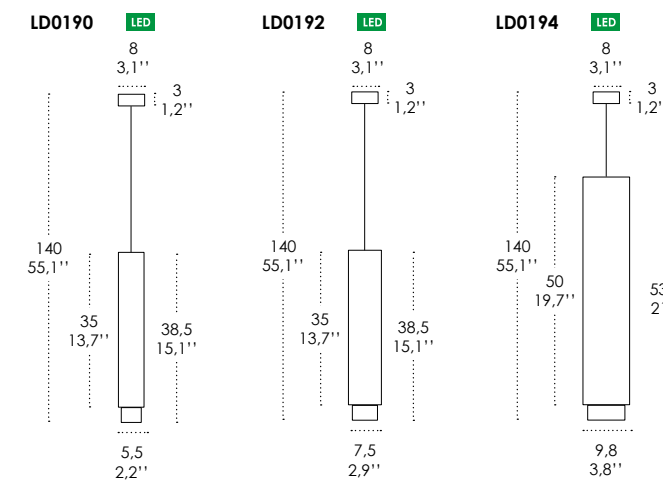

| LED 3000K CRI>80 220-240V IP20 | | | | | | | CE |
|--------------------------------|----------|--------|---------|---------|---------|------------|----|
| COD. | FINISHES | WATT | TOTAL W | Lm LED | Lm LAMP | BEAM ANGLE | |
| LD0190 | B3 - G3 | 8,6 W | 10 W | 900 lm | 750 lm | 20°-50° | |
| LD0192 | B3 - G3 | 17,5 W | 20 W | 2000 lm | 1600 lm | 20°-50° | |
| LD0194 | B3 - G3 | 24,5 W | 30 W | 3250 lm | 2600 lm | 20°-60° | |

Parete-soffitto / Wall-ceiling

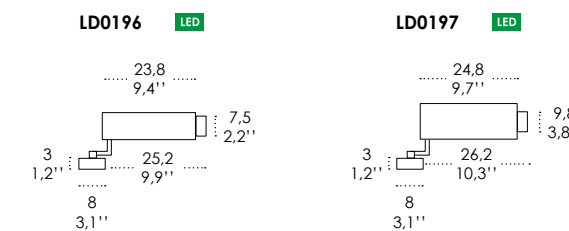

| LED 3000K CRI>80 220-240V IP20 | | | | | | | CE |
|--------------------------------|----------|--------|---------|---------|---------|------------|----|
| COD. | FINISHES | WATT | TOTAL W | Lm LED | Lm LAMP | BEAM ANGLE | |
| LD0196 | B3 - G3 | 17,5 W | 20 W | 2000 lm | 1600 lm | 20°-50° | |
| LD0197 | B3 - G3 | 24,5 W | 30 W | 3250 lm | 2600 lm | 20°-60° | |

Binario / Track

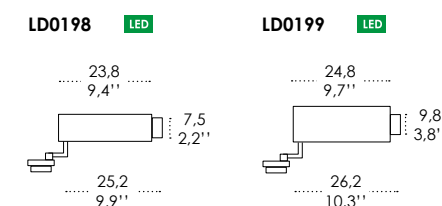

| LED 3000K CRI>80 220-240V IP20 | | | | | | | CE |
|--------------------------------|----------|--------|---------|---------|---------|------------|----|
| COD. | FINISHES | WATT | TOTAL W | Lm LED | Lm LAMP | BEAM ANGLE | |
| LD0198 | B3 - G3 | 17,5 W | 20 W | 2000 lm | 1600 lm | 20°-50° | |
| LD0199 | B3 - G3 | 24,5 W | 30 W | 3250 lm | 2600 lm | 20°-60° | |

MINE





MINE



Lampade da parete-soffitto con struttura in pressofusione di alluminio verniciato nei colori bianco o nero opaco, diffusore in policarbonato bianco satinato. Il prodotto è adatto esclusivamente all'uso interno.

Wall-ceiling lamps with a matt white or black painted die-cast aluminium frame and a white satin-finish polycarbonate diffuser. The product is suitable for indoor use only.

Parete-soffitto / Wall-ceiling

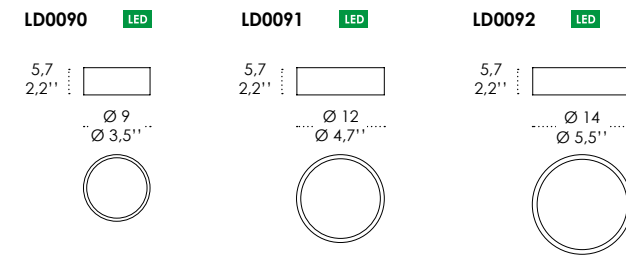

| LED 3000K CRI≥90 200-240V IP20  CE | | | | | | |
|-----------------------------------------------------------------------------------------------------------------------|----------|--------|---------|---------|---------|------------|
| COD. | FINISHES | WATT | TOTAL W | Lm LED | Lm LAMP | BEAM ANGLE |
| LD0090 | B3 - N3 | 5,4 W | 6,4 W | 594 lm | 420 lm | 100° |
| LD0091 | B3 - N3 | 9 W | 10,2 W | 990 lm | 830 lm | 100° |
| LD0092 | B3 - N3 | 12,6 W | 14,3 W | 1386 lm | 1085 lm | 100° |

SIXTIES

DESIGN_ Federico de Majo





SIXTIES



01
Bianco
White

Lampada a sospensione con diffusore in vetro triplex opale satinato soffiato a bocca, struttura in metallo bianco e cavi in tessuto bianco. Sixties è un prodotto personalizzabile, nei colori e nelle finiture, pensato anche per un uso modulare. Il prodotto è adatto esclusivamente all'uso interno.

Suspension lamp with diffuser in mouth-blown, satin-finish opal triplex glass, white painted metal frame and white fabric cables. Sixties is a customizable product, both in colours and finishes, designed also for modular use. The product is suitable for indoor use only.

Sospensione / Suspension

LSX0101 E27

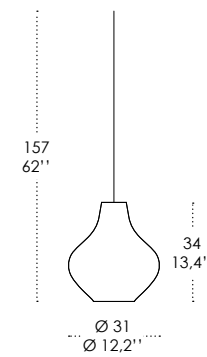

LSX1101 E27

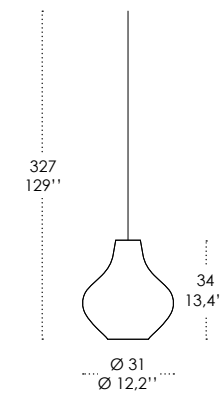

LSX2101 E27

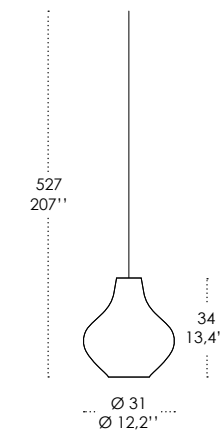

| E27 220-240V IP20 | | | | CE |
|-------------------|----------|-----------------|----------|----|
| COD. | FINISHES | LAMP CONNECTION | WATT MAX | |
| LSX01 | 01 | E27 | 70 HS | |
| LSX11 | 01 | E27 | 70 HS | |
| LSX21 | 01 | E27 | 70 HS | |

Rosoni compatibili a pag 310 / Compatible canopies at pag 310

TREVISO

DESIGN_Federico de Majo





TREVISO

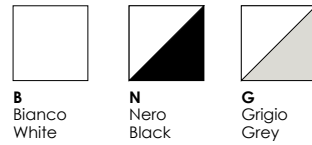

Lampade da parete-soffitto e a sospensione, con diffusore in vetro triplex opale satinato soffiato a bocca, con struttura in metallo verniciato bianco, nero e grigio opaco (personalizzabile con colori a richiesta); l'interno della struttura è sempre bianco.
Il prodotto è adatto esclusivamente all'uso interno.

Wall-ceiling and suspension lamps, with diffuser in mouth-blown, satin-finish opal triplex glass; matt white, black or grey painted metal frame; white painted metal frame, with outer finishing in matt white, black or grey painted (customisable on request).
The product is suitable for indoor use only.

Sospensione / Suspension

LED 2700K - 4000K su richiesta / on request

- LL121103
- LD121103
- LD121113
- LD121123
- LD121133
- LL121203
- LD121203
- LD121213
- LD121223
- LD121233
- LD124203

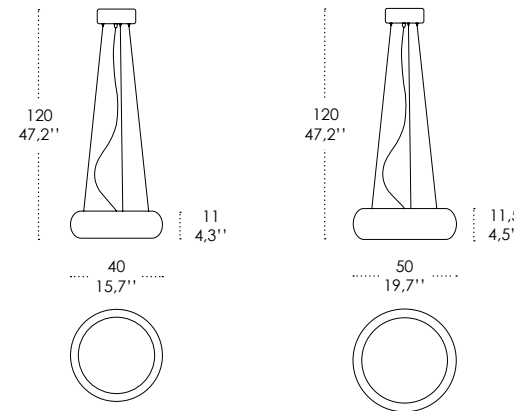

| E27 220-240V | | | |
|--------------|-----------|-----------------|-----------|
| COD. | FINISHES | LAMP CONNECTION | WATT MAX |
| LL121103 | B - N - G | E27 | 1 x 42 HS |
| LL121203 | B - N - G | E27 | 2 x 42 HS |
| LL121303 | B - N - G | E27 | 3 x 42 HS |
| LL121403 | B - N - G | E27 | 5 x 52 HS |

| LED 3000K CRI>90 220-240V | | | | | | |
|---------------------------|-----------|--------|---------|---------|---------|------------|
| COD. | FINISHES | WATT | TOTAL W | Lm LED | Lm LAMP | BEAM ANGLE |
| LD121103 | B - N - G | 10,5 W | 12,5 W | 1350 lm | 1110 lm | 120° |
| LD121203 | B - N - G | 17 W | 18,5 W | 2200 lm | 1510 lm | 120° |
| LD121303 | B - N - G | 27,5 W | 29 W | 3450 lm | 2070 lm | 120° |

| LED 3000K CRI>80 220-240V | | | | | | |
|---------------------------|-----------|------|---------|---------|---------|------------|
| COD. | FINISHES | WATT | TOTAL W | Lm LED | Lm LAMP | BEAM ANGLE |
| LD121403 | B - N - G | 67 W | 70 W | 7200 lm | 5060 lm | 120° |

- LL121303
- LD121303
- LD121313
- LD121323
- LD121333
- LD124303

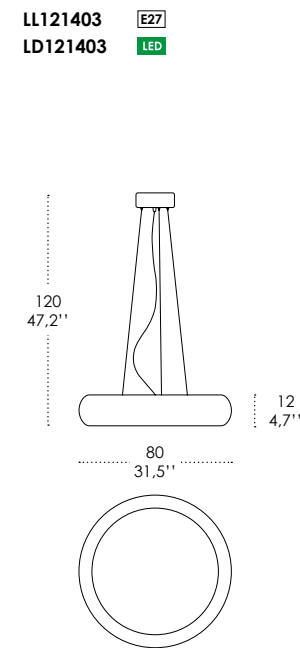

| LED DIMMER 3000K CRI>90 220-240V | | | | | | | |
|-----------------------------------|-----------|--------|---------|---------|---------|------------|--------|
| COD. | FINISHES | WATT | TOTAL W | Lm LED | Lm LAMP | BEAM ANGLE | DIMMER |
| LD121113 | B - N - G | 10,5 W | 12,5 W | 1350 lm | 1110 lm | 120° | TRIAC |
| LD121123 | B - N - G | 10,5 W | 12,5 W | 1350 lm | 1110 lm | 120° | DALI |
| LD121133 | B - N - G | 10,5 W | 18,5 W | 1350 lm | 1110 lm | 120° | WI-FI |
| LD121213 | B - N - G | 17 W | 18,5 W | 2200 lm | 1510 lm | 120° | TRIAC |
| LD121223 | B - N - G | 17 W | 18,5 W | 2200 lm | 1510 lm | 120° | DALI |
| LD121233 | B - N - G | 17 W | 18,5 W | 2200 lm | 1510 lm | 120° | WI-FI |
| LD121313 | B - N - G | 27,5 W | 29 W | 3450 lm | 2070 lm | 120° | TRIAC |
| LD121323 | B - N - G | 27,5 W | 29 W | 3450 lm | 2070 lm | 120° | DALI |
| LD121333 | B - N - G | 27,5 W | 29 W | 3450 lm | 2070 lm | 120° | WI-FI |

| LED EMERGENCY 3000K CRI>90 220-240V | | | | | | |
|-------------------------------------|-----------|--------|------------|---------|---------------|------------|
| COD. | FINISHES | WATT | TOTAL W | Lm LED | Lm LAMP | BEAM ANGLE |
| LD124303 | B - N - G | 27,5 W | 5 - 18,5 W | 3450 lm | 370 - 2070 lm | 120° |
| LD124203 | B - N - G | 17 W | 5 - 18,5 W | 2200 lm | 475 - 1510 lm | 120° |

Versione con dispositivo di emergenza integrato, con autonomia di 3 ore.
Version with integrated emergency device, with autonomy of 3 hours.



Parete-soffitto / Wall-ceiling

LED 2700K - 4000K su richiesta / on request

- LL120103
- LD120103
- LD120113
- LD120123
- LD120133
- LL120203
- LD120203
- LD120213
- LD120223
- LD120233
- LD127203

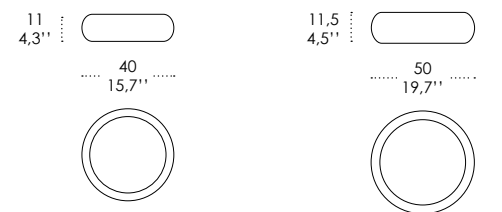

- LL120303
- LD120303
- LD120313
- LD120323
- LD120333
- LD127303
- LL120403
- LD120403

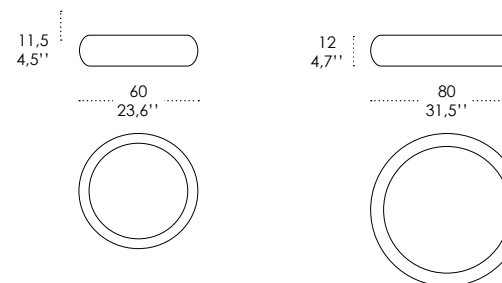

| E27 220-240V | | | |
|--------------|-----------|-----------------|-----------|
| COD. | FINISHES | LAMP CONNECTION | WATT MAX |
| LL120103 | B - N - G | E27 | 1 x 42 HS |
| LL120203 | B - N - G | E27 | 2 x 42 HS |
| LL120303 | B - N - G | E27 | 3 x 42 HS |

| E27 220-240V | | | |
|--------------|-----------|-----------------|-----------|
| COD. | FINISHES | LAMP CONNECTION | WATT MAX |
| LL120403 | B - N - G | E27 | 5 x 52 HS |

| LED 3000K CRI≥90 220-240V | | | | | | |
|---------------------------|-----------|--------|---------|---------|---------|------------|
| COD. | FINISHES | WATT | TOTAL W | Lm LED | Lm LAMP | BEAM ANGLE |
| LD120103 | B - N - G | 10,5 W | 12,5 W | 1350 lm | 1110 lm | 120° |
| LD120203 | B - N - G | 17 W | 18,5 W | 2200 lm | 1510 lm | 120° |
| LD120303 | B - N - G | 27,5 W | 29 W | 3450 lm | 2070 lm | 120° |

| LED 3000K CRI≥90 220-240V | | | | | | |
|---------------------------|-----------|------|---------|---------|---------|------------|
| COD. | FINISHES | WATT | TOTAL W | Lm LED | Lm LAMP | BEAM ANGLE |
| LD120403 | B - N - G | 67 W | 70 W | 7200 lm | 5060 lm | 120° |

LED 2700K - 4000K su richiesta / on request

| LED DIMMER 220-240V | | | | | | | |
|-----------------------|-----------|--------|---------|---------|---------|------------|--------|
| COD. | FINISHES | WATT | TOTAL W | Lm LED | Lm LAMP | BEAM ANGLE | DIMMER |
| LD120113 | B - N - G | 10,5 W | 12,5 W | 1350 lm | 1110 lm | 120° | TRIAC |
| LD120123 | B - N - G | 10,5 W | 12,5 W | 1350 lm | 1110 lm | 120° | DALI |
| LD120133 | B - N - G | 10,5 W | 12,5 W | 1350 lm | 1110 lm | 120° | Wi-Fi |
| LD120213 | B - N - G | 17 W | 18,5 W | 2200 lm | 1510 lm | 120° | TRIAC |
| LD120223 | B - N - G | 17 W | 18,5 W | 2200 lm | 1510 lm | 120° | DALI |
| LD120233 | B - N - G | 17 W | 18,5 W | 2200 lm | 1510 lm | 120° | Wi-Fi |
| LD120313 | B - N - G | 27,5 W | 29 W | 3450 lm | 2070 lm | 120° | TRIAC |
| LD120323 | B - N - G | 27,5 W | 29 W | 3450 lm | 2070 lm | 120° | DALI |
| LD120333 | B - N - G | 27,5 W | 29 W | 3450 lm | 2070 lm | 120° | Wi-Fi |

| LED EMERGENCY 220-240V | | | | | | |
|--------------------------|-----------|--------|------------|---------|---------------|------------|
| COD. | FINISHES | WATT | TOTAL W | Lm LED | Lm LAMP | BEAM ANGLE |
| LD127203 | B - N - G | 17 W | 5 - 18,5 W | 2200 lm | 475 - 1510 lm | 120° |
| LD127303 | B - N - G | 27,5 W | 5 - 29 W | 3450 lm | 370 - 2070 lm | 120° |

Versione con dispositivo di emergenza integrato, con autonomia di 3 ore.
Version with integrated emergency device, with autonomy of 3 hours.

MENTOS

DESIGN_ Federico de Majo



MENTOS



B
Bianco
White

Lampade da parete-soffitto e a sospensione, con diffusore in vetro triplex opale satinato soffiato a bocca, con struttura in metallo verniciato bianco opaco.

La collezione Mentos ha un particolare sistema di fissaggio del vetro a magneti che velocizza le installazioni e facilita le operazioni di manutenzione. Il prodotto è adatto esclusivamente all'uso interno.

Wall-ceiling and suspension lamps with diffuser in mouth-blown, satin-finish opal triplex glass; matt white painted metal frame.

The Mentos collection features a special magnet fixing system for the glass component: this system simplifies and speeds up the installation and is highly practical when standard maintenance is required.

The product is suitable for indoor use only.



Parete-soffitto / Wall-ceiling

LED 2700K - 4000K su richiesta / on request

- LD110203
- LD110234
- LD110235
- LD110236
- LD110303
- LD110353
- LD110363
- LD110373
- LD110343

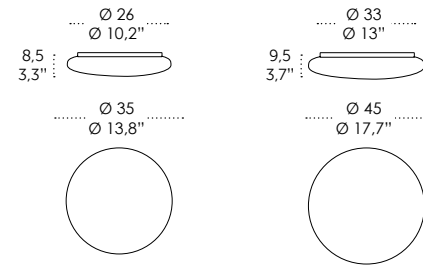

- LD110403
- LD110453
- LD110463
- LD110473
- LD110443

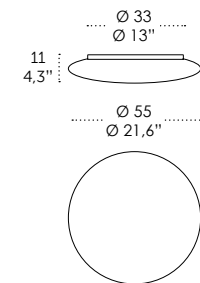

| LED 3000K CRI≥90 220-240V IP20 | | | | | | | CE |
|--------------------------------|----------|--------|---------|---------|---------|------------|----|
| COD. | FINISHES | POWER | TOTAL W | Lm LED | Lm LAMP | BEAM ANGLE | |
| LD110203 | B | 17 W | 18,5 W | 2200 lm | 1510 lm | 130° | |
| LD110303 | B | 27,5 W | 29 W | 3450 lm | 2070 lm | 130° | |
| LD110403 | B | 27,5 W | 29 W | 3450 lm | 2070 lm | 130° | |

| LED DIMMER 3000K CRI≥90 220-240V IP20 | | | | | | | | CE |
|---------------------------------------|----------|--------|---------|---------|---------|--------|------------|----|
| COD. | FINISHES | POWER | TOTAL W | Lm LED | Lm LAMP | DIMMER | BEAM ANGLE | |
| LD110234 | B | 17 W | 18,5 W | 2200 lm | 1510 lm | TRIAC | 130° | |
| LD110235 | B | 17 W | 18,5 W | 2200 lm | 1510 lm | DALI | 130° | |
| LD110236 | B | 17 W | 18,5 W | 2200 lm | 1510 lm | WI-FI | 130° | |
| LD110353 | B | 27,5 W | 29 W | 3450 lm | 2070 lm | TRIAC | 130° | |
| LD110363 | B | 27,5 W | 29 W | 3450 lm | 2070 lm | DALI | 130° | |
| LD110373 | B | 27,5 W | 29 W | 3450 lm | 2070 lm | WI-FI | 130° | |
| LD110453 | B | 27,5 W | 29 W | 3450 lm | 2070 lm | TRIAC | 130° | |
| LD110463 | B | 27,5 W | 29 W | 3450 lm | 2070 lm | DALI | 130° | |
| LD110473 | B | 27,5 W | 29 W | 3450 lm | 2070 lm | WI-FI | 130° | |

| LED EMERGENCY 3000K CRI≥90 220-240V IP20 | | | | | | | CE |
|------------------------------------------|----------|--------|----------|---------|---------------|------------|----|
| COD. | FINISHES | POWER | TOTAL W | Lm LED | Lm LAMP | BEAM ANGLE | |
| LD110343 | B | 27,5 W | 5 - 29 W | 3450 lm | 370 - 2070 lm | 130° | |
| LD110443 | B | 27,5 W | 5 - 29 W | 3450 lm | 370 - 2070 lm | 130° | |

Versione con dispositivo di emergenza integrato, con autonomia di 3 ore.
Version with integrated emergency device, with autonomy of 3 hours.

Sospensione / Suspension

LED 2700K - 4000K su richiesta / on request

- LD112203
- LD112233
- LD112243
- LD112253
- LD113303
- LD113333
- LD113343
- LD113353

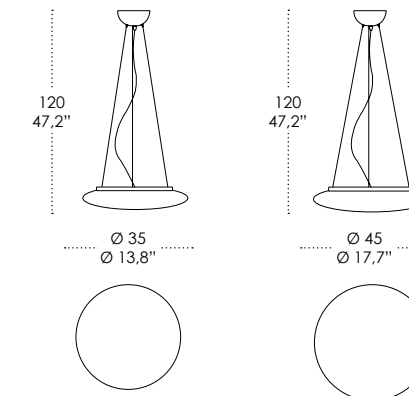

- LD114403
- LD114433
- LD114443
- LD114453

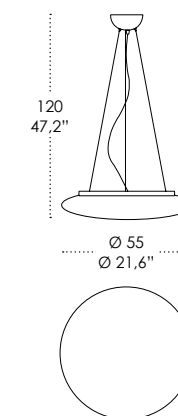

| LED 3000K CRI≥90 220-240V IP20 | | | | | | | CE |
|--------------------------------|----------|--------|---------|---------|---------|------------|----|
| COD. | FINISHES | POWER | TOTAL W | Lm LED | Lm LAMP | BEAM ANGLE | |
| LD112203 | B | 17 W | 18,5 W | 2200 lm | 1510 lm | 130° | |
| LD113303 | B | 27,5 W | 29 W | 3450 lm | 2070 lm | 130° | |
| LD114403 | B | 27,5 W | 29 W | 3450 lm | 2070 lm | 130° | |

| LED DIMMER 3000K CRI≥90 220-240V IP20 | | | | | | | | CE |
|---------------------------------------|----------|--------|---------|---------|---------|--------|------------|----|
| COD. | FINISHES | POWER | TOTAL W | Lm LED | Lm LAMP | DIMMER | BEAM ANGLE | |
| LD112233 | B | 17 W | 18,5 W | 2200 lm | 1510 lm | TRIAC | 130° | |
| LD112243 | B | 17 W | 18,5 W | 2200 lm | 1510 lm | DALI | 130° | |
| LD112253 | B | 17 W | 18,5 W | 2200 lm | 1510 lm | WI-FI | 130° | |
| LD113333 | B | 27,5 W | 29 W | 3450 lm | 2070 lm | TRIAC | 130° | |
| LD113343 | B | 27,5 W | 29 W | 3450 lm | 2070 lm | DALI | 130° | |
| LD113353 | B | 27,5 W | 29 W | 3450 lm | 2070 lm | WI-FI | 130° | |
| LD114433 | B | 27,5 W | 29 W | 3450 lm | 2070 lm | TRIAC | 130° | |
| LD114443 | B | 27,5 W | 29 W | 3450 lm | 2070 lm | DALI | 130° | |
| LD114453 | B | 27,5 W | 29 W | 3450 lm | 2070 lm | WI-FI | 130° | |

SFERIS





SFERIS

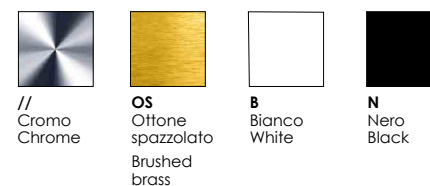

Lampade a sospensione, da soffitto e da tavolo con diffusore in vetro triplex opale satinato soffiato a bocca, e struttura in metallo cromato, ottone spazzolato o verniciato bianco o nero opaco. Sferis è un prodotto pensato anche per un uso modulare.

Il prodotto è adatto esclusivamente all'uso interno; disponibile su richiesta la versione con IP44, idonea anche per bagni e sopra specchi.

Suspension, ceiling and table lamps with diffuser in mouth-blown, satin-finish opal triplex glass; chromed, brushed brass finish or matt white or black painted metal frame. Sferis is designed also for modular use.

The product is suitable for indoor use only; a version with IP44 rating - ideal for bathrooms and installation above mirrors - is available on request.

Soffitto / Ceiling

IP44 su richiesta / on request

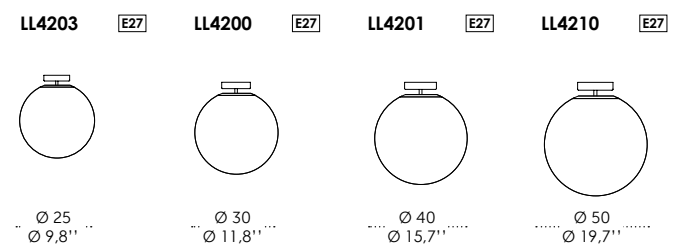

| E27 220-240V IP20 | | | | CE |
|-------------------|-----------------|-----------------|------------|----|
| COD. | FINISHES | LAMP CONNECTION | WATT MAX | |
| LL4203 | // - OS - B - N | E27 | 1 x 52 HS | |
| LL4200 | // - OS - B - N | E27 | 1 x 70 HS | |
| LL4201 | // - OS - B - N | E27 | 1 x 70 HS | |
| LL4210 | // - OS - B - N | E27 | 1 x 105 HS | |

Sospensione / Suspension

IP44 su richiesta / on request

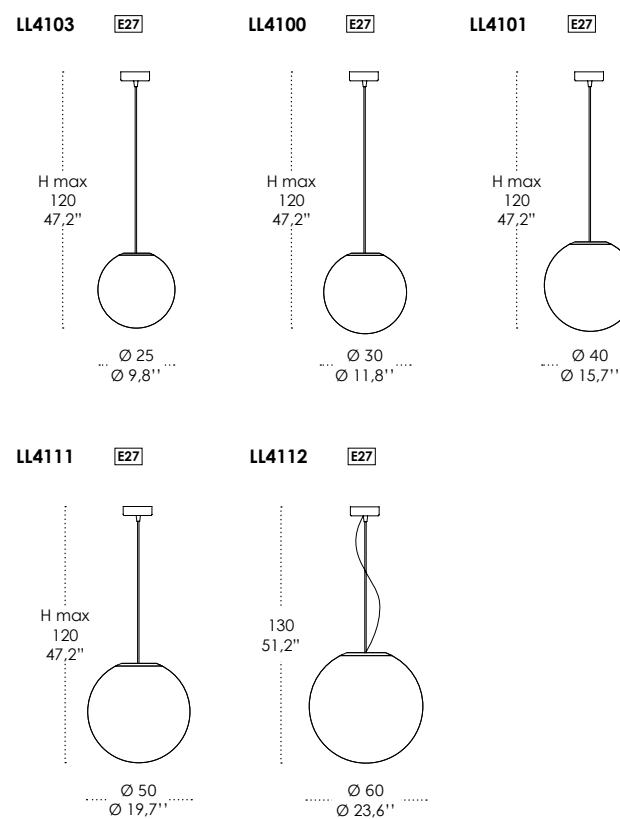

| E27 220-240V IP20 | | | | CE |
|-------------------|-----------------|-----------------|------------|----|
| COD. | FINISHES | LAMP CONNECTION | WATT MAX | |
| LL4103 | // - OS - B - N | E27 | 1 x 52 HS | |
| LL4100 | // - OS - B - N | E27 | 1 x 70 HS | |
| LL4101 | // - OS - B - N | E27 | 1 x 70 HS | |
| LL4111 | // - OS - B - N | E27 | 1 x 105 HS | |
| LL4112 | // - OS - B - N | E27 | 2 x 52 HS | |

Rosone / Canopy

Available on:
E27 IP20: Ø 25 - 30 - 40 - 50 - 60 cm

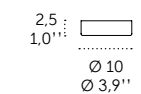

Available on:
E27 IP44: Ø 25 - 30 - 40 - 50 cm

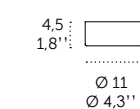

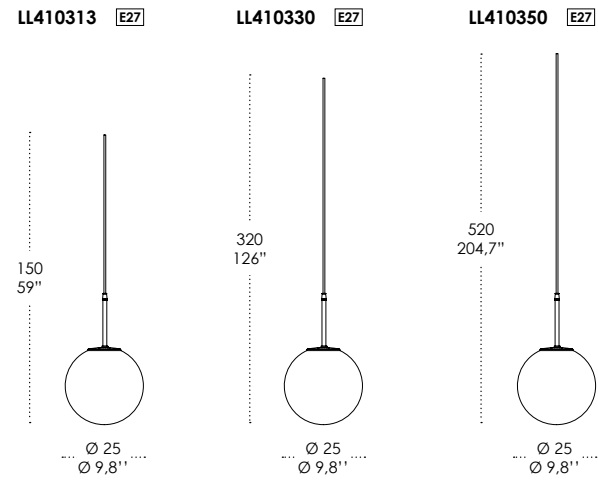

| E27 220-240V IP20 | | | | CE |
|-------------------|-----------------|-----------------|-----------|----|
| COD. | FINISHES | LAMP CONNECTION | WATT MAX | |
| LL410313 | // - OS - B - N | E27 | 1 x 52 HS | |
| LL410330 | // - OS - B - N | E27 | 1 x 52 HS | |
| LL410350 | // - OS - B - N | E27 | 1 x 52 HS | |
| LL410013 | // - OS - B - N | E27 | 1 x 70 HS | |
| LL410030 | // - OS - B - N | E27 | 1 x 70 HS | |
| LL410050 | // - OS - B - N | E27 | 1 x 70 HS | |
| LL410113 | // - OS - B - N | E27 | 1 x 70 HS | |
| LL410130 | // - OS - B - N | E27 | 1 x 70 HS | |
| LL410150 | // - OS - B - N | E27 | 1 x 70 HS | |

Rosoni compatibili a pag 310 / Compatible canopies at pag 310

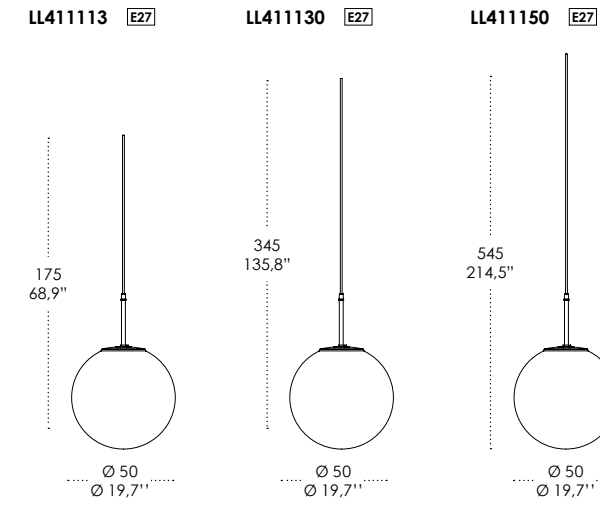
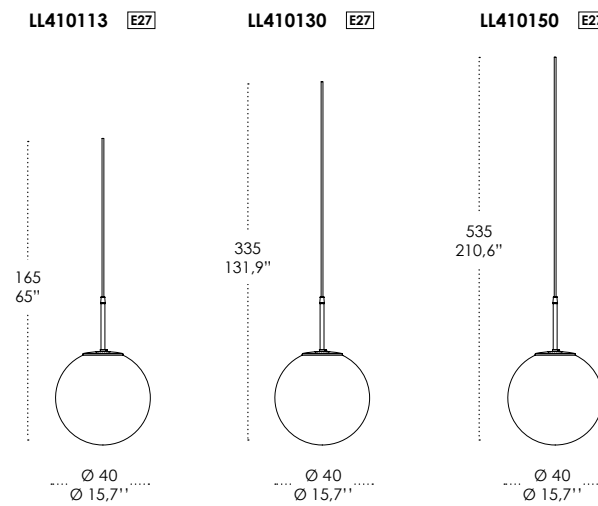
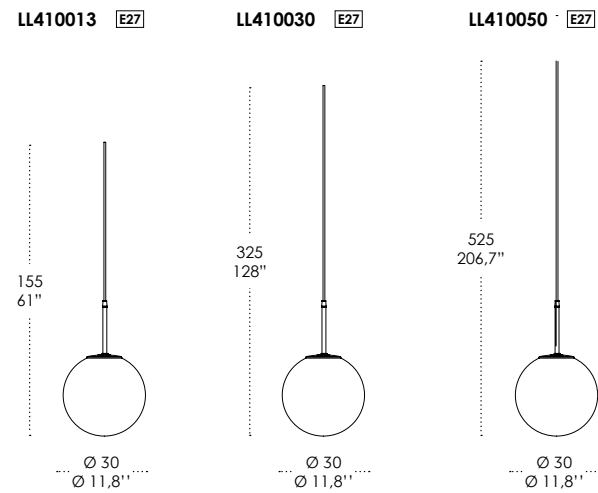

| E27 220-240V IP20 | | | | CE |
|-------------------|-----------------|-----------------|------------|----|
| COD. | FINISHES | LAMP CONNECTION | WATT MAX | |
| LL411113 | // - OS - B - N | E27 | 1 x 105 HS | |
| LL411130 | // - OS - B - N | E27 | 1 x 105 HS | |
| LL411150 | // - OS - B - N | E27 | 1 x 105 HS | |

Rosoni compatibili a pag 310 / Compatible canopies at pag 310

Tavolo / Table

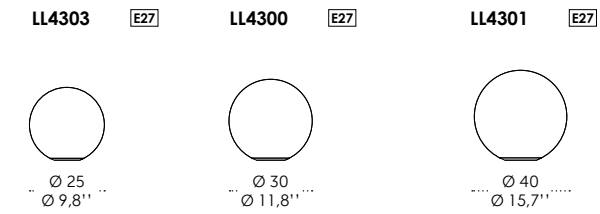

| E27 220-240V IP20 | | | | CE |
|-------------------|----------|-----------------|-----------|----|
| COD. | FINISHES | LAMP CONNECTION | WATT MAX | |
| LL4303 | B - N | E27 | 1 x 52 HS | |
| LL4300 | B - N | E27 | 1 x 70 HS | |
| LL4301 | B - N | E27 | 1 x 70 HS | |

PALLINA





PALLINA

Lampade da incasso, da parete-soffitto, a sospensione e da tavolo con diffusore in vetro triplex opale satinato soffiato a bocca, e struttura in metallo cromato.
Il prodotto è adatto esclusivamente all'uso interno.

Recessed, wall-ceiling, suspension and table lamps with diffuser in mouth-blown, satin-finish opal triplex glass; chromed metal frame. The product is suitable for indoor use only.

Elemento componibile - gruppo luce / Modular element - lamp component kit

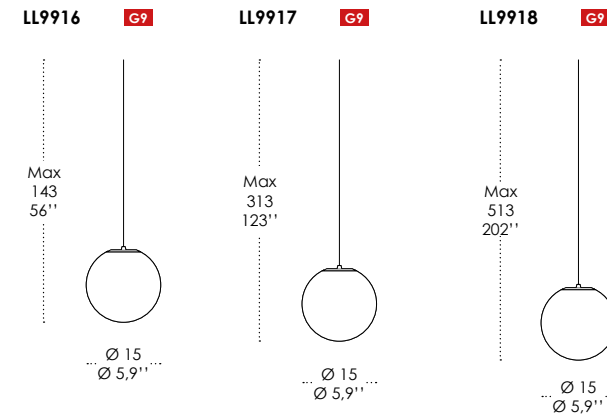

| G9 220-240V IP20 | | | CE |
|------------------|-----------------|----------|----|
| COD. | LAMP CONNECTION | WATT MAX | |
| LL9916 | G9 | 33 HS | |
| LL9917 | G9 | 33 HS | |
| LL9918 | G9 | 33 HS | |

Lampadina G9 non inclusa / G9 bulb not included
Rosoni compatibili a pag 310 / Compatible canopies at pag 310

Parete-soffitto / Wall-ceiling

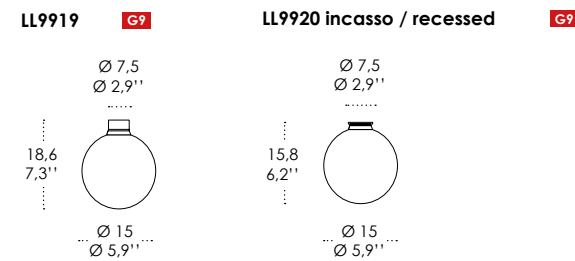

| G9 220-240V IP20 | | | CE |
|------------------|-----------------|----------|----|
| COD. | LAMP CONNECTION | WATT MAX | |
| LL9919 | G9 | 33 HS | |
| LL9920 | G9 | 33 HS | |

Lampadina G9 non inclusa / G9 bulb not included

Tavolo / Table

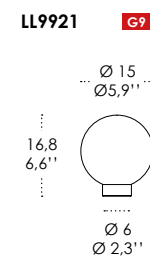

| G9 220-240V IP20 | | | CE |
|------------------|-----------------|----------|----|
| COD. | LAMP CONNECTION | WATT MAX | |
| LL9921 | G9 | 33 HS | |

Lampadina G9 non inclusa / G9 bulb not included

Lampadina / Bulb

Compatibile con la maggior parte dei dimmer a taglio di fase in commercio / Compatible with most Triac dimmers available on the market

| LED 2700K CRI≥80 220-240V 50 Hz | | | | | CE |
|---------------------------------|-----------------|-------|-----------|------------|----|
| COD. | BULB CONNECTION | WATT | LUMEN LED | BEAM ANGLE | |
| LD0180901 | G9 | 4,5 W | 480 lm | 360° | |

| LED 3000K CRI≥80 220-240V 50 Hz | | | | | CE |
|---------------------------------|-----------------|-------|-----------|------------|----|
| COD. | BULB CONNECTION | WATT | LUMEN LED | BEAM ANGLE | |
| LD0180900 | G9 | 4,5 W | 500 lm | 360° | |

DADO





DADO

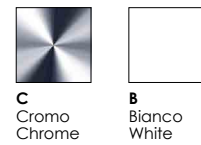

Lampade da parete-soffitto e da tavolo con struttura in metallo cromato oppure verniciato bianco opaco e diffusore in vetro triplex opale satinato soffiato a bocca.

La collezione Dado ha un particolare sistema di fissaggio del vetro a magneti che velocizza le installazioni e semplifica le operazioni di manutenzione.

Il prodotto è adatto esclusivamente all'uso interno.

Wall-ceiling and table lamps with chromed or matt white painted metal frame; diffuser in mouth-blown, satin-finish opal triplex glass.

The Dado collection features a special magnet fixing system for the glass component: this system simplifies and speeds up the installation and is highly practical when standard maintenance is required.

The product is suitable for indoor use only.

Parete-soffitto / Wall-ceiling

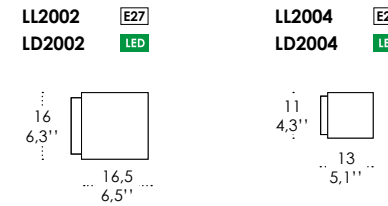

| E27 220-240V IP40 | | | | CE |
|-------------------|----------|-----------------|----------|----|
| COD. | FINISHES | LAMP CONNECTION | WATT MAX | |
| LL2002 | C - B | E27 | 28 HS | |
| LL2004 | C - B | E27 small bulb | 28 HSGS | |

| LED 2900K CRI>80 220-240V IP40 | | | | | CE |
|--------------------------------|----------|---------|--------|---------|----|
| COD. | FINISHES | TOTAL W | Lm LED | Lm LAMP | |
| LD2002 | C - B | 8 W | 750 lm | 290 lm | |
| LD2004 | C - B | 4 W | 420 lm | 190 lm | |

Tavolo / Table

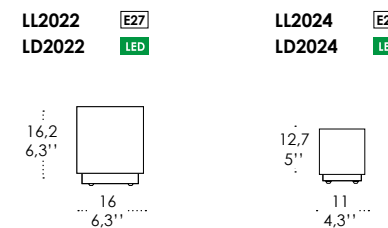

| E27 220-240V IP40 | | | | CE |
|-------------------|----------|-----------------|----------|----|
| COD. | FINISHES | LAMP CONNECTION | WATT MAX | |
| LL2022 | C - B | E27 | 28 HS | |
| LL2024 | C - B | E27 small bulb | 28 HSGS | |

| LED 2900K CRI>80 220-240V IP40 | | | | | CE |
|--------------------------------|----------|---------|--------|---------|----|
| COD. | FINISHES | TOTAL W | Lm LED | Lm LAMP | |
| LD2022 | C - B | 8 W | 750 lm | 290 lm | |
| LD2024 | C - B | 4 W | 420 lm | 190 lm | |



Sistema di fissaggio a magneti
Magnet fixing system

CAORLE



Bianco
White

Lampade da parete-soffitto con diffusore in vetro triplex opale satinato soffiato a bocca, e struttura in metallo verniciato bianco opaco. Il prodotto è adatto esclusivamente all'uso interno.

Wall-ceiling lamps with diffuser in mouth-blown, satin-finish opal triplex glass; matt white painted metal frame. The product is suitable for indoor use only.

Parete-soffitto / Wall-ceiling

LED 2700K - 4000K su richiesta / on request

LL1304
LD130403

8,8
3,5"

18
7,1"
18
7,1"

LL1305
LD130503
LD130513
LD130523
LD130533

8,8
3,5"

25
9,8"
25
9,8"

LL1306
LD130603
LD130613
LD130623
LD130633
LD133603

8,8
3,5"

32
12,6"
32
12,6"

| E27 220-240V | | | CE |
|--------------|-----------------|-----------|----|
| COD. | LAMP CONNECTION | WATT MAX | |
| LL1304 | E27 | 1 x 28 HS | |
| LL1305 | E27 | 2 x 28 HS | |
| LL1306 | E27 | 3 x 28 HS | |

| LED 3000K 220-240V | | | | | | | CE |
|--------------------|--------|---------|---------|---------|------------|-----|----|
| COD. | WATT | TOTAL W | Lm LED | Lm LAMP | BEAM ANGLE | CRI | |
| LD130403 | 8,7 W | 10 W | 1310 lm | 480 lm | 130° | >80 | |
| LD130503 | 10,5 W | 12,5 W | 1350 lm | 1110 lm | 130° | ≥90 | |
| LD130603 | 17 W | 18,5 W | 2200 lm | 1510 lm | 130° | ≥90 | |

| LED DIMMER 3000K CRI≥90 220-240V | | | | | | | CE |
|-----------------------------------|--------|---------|---------|---------|------------|--------|----|
| COD. | WATT | TOTAL W | Lm LED | Lm LAMP | BEAM ANGLE | DIMMER | |
| LD130513 | 10,5 W | 12,5 W | 1350 lm | 1110 lm | 130° | TRIAC | |
| LD130523 | 10,5 W | 12,5 W | 1350 lm | 1110 lm | 130° | DALI | |
| LD130533 | 10,5 W | 12,5 W | 1350 lm | 1110 lm | 130° | WI-FI | |
| LD130613 | 17 W | 18,5 W | 2200 lm | 1510 lm | 130° | TRIAC | |
| LD130623 | 17 W | 18,5 W | 2200 lm | 1510 lm | 130° | DALI | |
| LD130633 | 17 W | 18,5 W | 2200 lm | 1510 lm | 130° | WI-FI | |

| LED EMERGENCY 3000K CRI≥90 220-240V | | | | | | CE |
|-------------------------------------|------|------------|---------|---------------|------------|----|
| COD. | WATT | TOTAL W | Lm LED | Lm LAMP | BEAM ANGLE | |
| LD133603 | 17 W | 5 - 18,5 W | 2200 lm | 475 - 1510 lm | 130° | |

Versione con dispositivo di emergenza integrato, con autonomia di 3 ore.
Version with integrated emergency device, with autonomy of 3 hours.

RIALTO



RIALTO

Lampade da parete-soffitto con diffusore in vetro triplex opale satinato soffiato a bocca, e struttura in metallo verniciato bianco opaco. Il prodotto è adatto esclusivamente all'uso interno.

Wall-ceiling lamps with diffuser in mouth-blown, satin-finish opal triplex glass; matt white painted metal frame. The product is suitable for indoor use only.

Parete-soffitto / Wall-ceiling

LED 2700K - 4000K su richiesta / on request



LL3060 E27
LD306003 LED

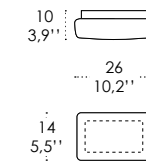

LL3040 E27
LD307003 LED

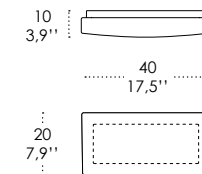

LL3070 E27
LD304003 LED

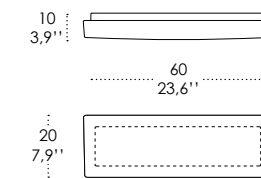

LL3020 E27
LD302003 LED
LD302013 LED TRIAC
LD302023 LED DALI
LD302033 LED WI-FI
LD309203 LED EMERGENCY

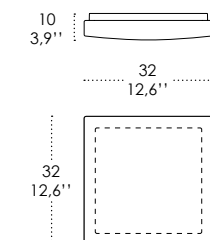

LL3030 E27
LD303003 LED
LD303013 LED TRIAC
LD303023 LED DALI
LD303033 LED WI-FI
LD309103 LED EMERGENCY

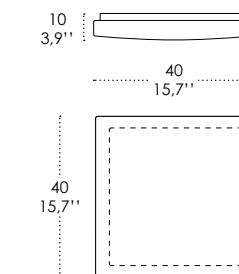

| E27 220-240V IP40 | | | CE |
|-------------------|-----------------|-----------|----|
| COD. | LAMP CONNECTION | WATT MAX | |
| LL3060 | E27 | 1 x 70 HS | |
| LL3040 | E27 | 2 x 52 HS | |
| LL3020 | E27 | 2 x 52 HS | |
| LL3030 | E27 | 2 x 70 HS | |
| LL3070 | E27 | 3 x 52 HS | |

| LED 3000K CRI>80 220-240V IP20 | | | | | | CE |
|--------------------------------|--------|---------|---------|---------|------------|----|
| COD. | WATT | TOTAL W | Lm LED | Lm LAMP | BEAM ANGLE | |
| LD304003 | 26,1 W | 30 W | 3930 lm | 1440 lm | 130° | |
| LD306003 | 8,7 W | 10 W | 1310 lm | 480 lm | 130° | |
| LD307003 | 17,4 W | 20 W | 2620 lm | 960 lm | 130° | |

| LED 3000K CRI>90 220-240V IP40 | | | | | | CE |
|--------------------------------|--------|---------|---------|---------|------------|----|
| COD. | WATT | TOTAL W | Lm LED | Lm LAMP | BEAM ANGLE | |
| LD302003 | 17 W | 18,5 W | 2200 lm | 1510 lm | 130° | |
| LD303003 | 27,5 W | 29 W | 3450 lm | 2070 lm | 130° | |

| LED DIMMER 3000K CRI>90 220-240V IP40 | | | | | | | CE |
|---------------------------------------|--------|--------|---------|---------|------------|--------|----|
| COD. | POWER | TOTAL | Lm LED | Lm LAMP | BEAM ANGLE | DIMMER | |
| LD302013 | 17 W | 18,5 W | 2200 lm | 1510 lm | 130° | TRIAC | |
| LD302023 | 17 W | 18,5 W | 2200 lm | 1510 lm | 130° | DALI | |
| LD302033 | 17 W | 18,5 W | 2200 lm | 1510 lm | 130° | WI-FI | |
| LD303013 | 27,5 W | 29 W | 3450 lm | 2070 lm | 130° | TRIAC | |
| LD303023 | 27,5 W | 29 W | 3450 lm | 2070 lm | 130° | DALI | |
| LD303033 | 27,5 W | 29 W | 3450 lm | 2070 lm | 130° | WI-FI | |

| LED EMERGENCY 3000K CRI>90 220-240V IP40 | | | | | | CE |
|------------------------------------------|--------|------------|---------|---------------|------------|----|
| COD. | POWER | TOTAL | Lm LED | Lm LAMP | BEAM ANGLE | |
| LD309203 | 17 W | 5 - 18,5 W | 2200 lm | 475 - 1510 lm | 130° | |
| LD309103 | 27,5 W | 5 - 29 W | 3450 lm | 370 - 2070 lm | 130° | |

Versione con dispositivo di emergenza integrato, con autonomia di 3 ore.
Version with integrated emergency device, with autonomy of 3 hours.

LUCCA

DESIGN_Federico de Majo

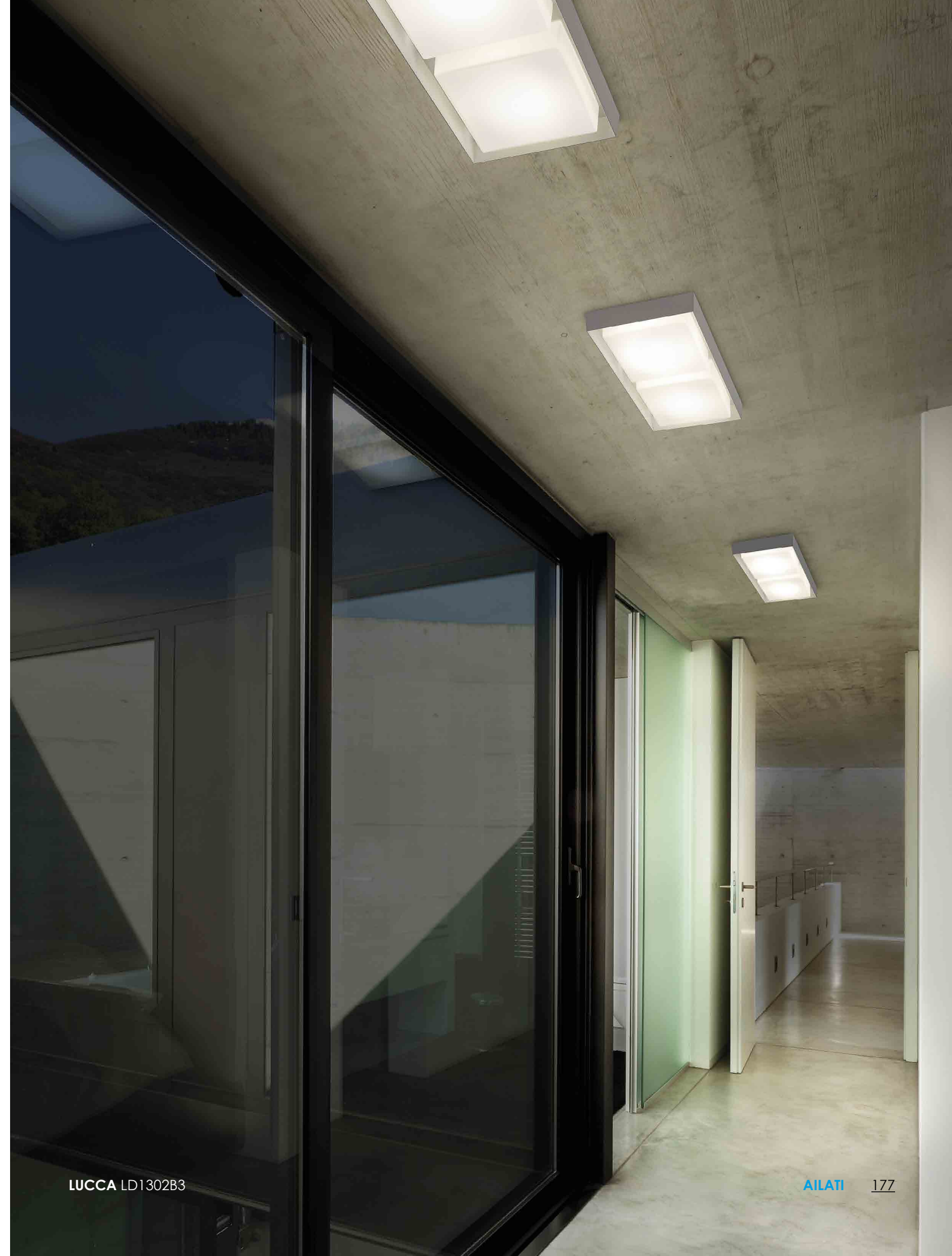





LUCCA

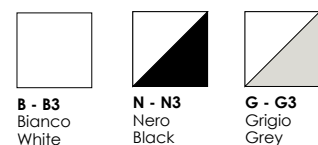

Lampade da parete-soffitto con diffusore in vetro triplex opale satinato soffiato a bocca, e struttura in metallo verniciato bianco, nero e grigio opaco (personalizzabile con colori a richiesta); l'interno della struttura è sempre bianco.

Wall-ceiling lamps with diffuser in mouth-blown, satin-finish opal triplex glass; white painted metal frame, with outer finishing in matt white, black or grey painted (customisable on request).

Il prodotto è adatto esclusivamente all'uso interno.

Parete-soffitto / Wall-ceiling

LED 2700K - 4000K su richiesta / on request

LL1303 **LD1303** **LD1313** **LD1323** **LD1333**

LL1302 **LD1302**

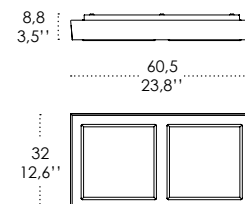
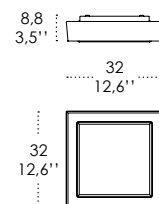

LL1301 **LD1301**

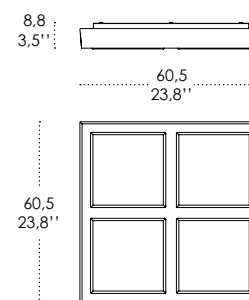

| E27 220-240V | | | |
|--------------|-----------|-----------------|-----------|
| COD. | FINISHES | LAMP CONNECTION | WATT MAX |
| LL1303 | B - N - G | 2 x E27 | 2 x 28 HS |
| LL1302 | B - N - G | 4 x E27 | 4 x 28 HS |
| LL1301 | B - N - G | 8 x E27 | 8 x 28 HS |

| LED 3000K CRI≥90 220-240V | | | | | | |
|---------------------------|------------|------------|------------|-------------|-------------|------------|
| COD. | FINISHES | WATT | TOTAL W | lm LED | lm LAMP | BEAM ANGLE |
| LD1303 | B3 - N3 G3 | 10,5 W | 12,5 W | 1350 lm | 1110 lm | 120° |
| LD1302 | B3 - N3 G3 | 2 x 10,5 W | 2 x 12,5 W | 2 x 1350 lm | 2 x 1110 lm | 120° |
| LD1301 | B3 - N3 G3 | 4 x 10,5 W | 4 x 12,5 W | 4 x 1350 lm | 4 x 1110 lm | 120° |

| LED DIMMER 3000K CRI≥90 220-240V | | | | | | | |
|-----------------------------------|------------|--------|---------|---------|---------|--------|------------|
| COD. | FINISHES | WATT | TOTAL W | lm LED | lm LAMP | DIMMER | BEAM ANGLE |
| LD1313 | B3 - N3 G3 | 10,5 W | 12,5 W | 1350 lm | 1110 lm | TRIAC | 120° |
| LD1323 | B3 - N3 G3 | 10,5 W | 12,5 W | 1350 lm | 1110 lm | DALI | 120° |
| LD1333 | B3 - N3 G3 | 10,5 W | 12,5 W | 1350 lm | 1110 lm | WI-FI | 120° |

STAND





Lampada da parete-soffitto con diffusore in vetro triplex opale satinato soffiato a bocca, e struttura in metallo verniciato bianco opaco. Il prodotto è adatto esclusivamente all'uso interno.



Wall-ceiling lamp with diffuser in mouth-blown, satin-finish opal triplex glass; matt white painted metal frame. The product is suitable for indoor use only.

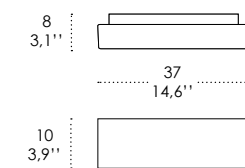

Parete-soffitto / Wall-ceiling

LED 2700K - 4000K su richiesta / on request

LL3001 
LD300103 



| E27 220-240V   | | | | CE |
|------------------------------------------------------------------------------------------------------------------------------------------------------------------------------------------|-----------------|-------------|--|----|
| COD. | LAMP CONNECTION | WATT MAX | | |
| LL3001 | 2 x E27 | 2 x 28 HSGS | | |

| LED 3000K CRI>80 220-240V   | | | | | | CE |
|-------------------------------------------------------------------------------------------------------------------------------------------------------------------------------------------------------|--------|---------|---------|---------|------------|----|
| COD. | WATT | TOTAL W | Lm LED | Lm LAMP | BEAM ANGLE | |
| LD300103 | 17,4 W | 20 W | 2620 lm | 960 lm | 130° | |

STAND METAL



C-C3
Cromo
Chrome



B-B3
Bianco
White

Lampada da parete-soffitto con diffusore in vetro triplex opale satinato soffiato a bocca, e struttura in metallo cromato o verniciato bianco opaco.
Il prodotto è adatto esclusivamente all'uso interno.

Wall-ceiling lamps with diffuser in mouth-blown, satin-finish opal triplex glass; chromed or matt white painted metal frame.
The product is suitable for indoor use only.

Parete-soffitto / Wall-ceiling

LED 2700K - 4000K su richiesta / on request

LL3001
LD3001

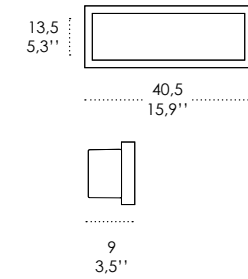

| E27 220-240V | | | CE |
|---------------|---------------------|-------------|----|
| COD. | METAL PART FINISHES | WATT MAX | |
| LL3001 | C - B | 2 x 28 HSGS | |

| LED 3000K CRI>80 220-240V | | | | | | | CE |
|---------------------------|---------------------|--------|---------|---------|---------|------------|----|
| COD. | METAL PART FINISHES | WATT | TOTAL W | Lm LED | Lm LAMP | BEAM ANGLE | |
| LD3001 | C3 - B3 | 17,4 W | 20 W | 2620 Lm | 960 Lm | 130° | |

OMEGA



C3
Cromo
Chrome

Lampada da parete-soffitto in vetro triplex opale satinato soffiato a bocca, e struttura in metallo cromato.
Il prodotto è adatto esclusivamente all'uso interno. Omega ha un grado di protezione IP44, idonea anche per bagni e sopra specchi.

Wall-ceiling lamps with diffuser in mouth-blown, satin-finish opal triplex glass; chromed metal frame.
The product is suitable for indoor use only. The IP44 rating makes it ideal for bathrooms and installation above mirrors.

Parete-soffitto / Wall-ceiling

LD9566C3 LED

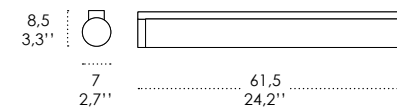

| LED 3000K CRI≥90 220-240V IP44 | | | | | | | CE |
|--------------------------------|----------|------|---------|---------|---------|------------|----|
| COD. | FINISHES | WATT | TOTAL W | Lm LED | Lm LAMP | BEAM ANGLE | |
| LD9566 | C3 | 18 W | 20 W | 1980 lm | 1290 lm | 120° | |

STICK







STICK



Cromo
Chrome



Bianco
White

Lampade da parete, da parete-soffitto e a sospensione con diffusore in vetro triplex opale satinato soffiato a bocca, e struttura in metallo cromato o verniciato bianco opaco.

Il prodotto è adatto esclusivamente all'uso interno; il modello Stick 65 con grado di protezione IP44 è idoneo anche per bagni e sopra specchi.

Stick sospensione è un prodotto pensato anche per un uso modulare.

Wall, wall-ceiling and suspension lamps with diffuser in mouth-blown, satin-finish opal triplex glass; chromed or matt white painted metal frame.

The collection is suitable for indoor use only; the IP44 rating makes Stick 65 ideal for bathrooms and installation above mirrors.

The suspension version of Stick is designed also for modular use.

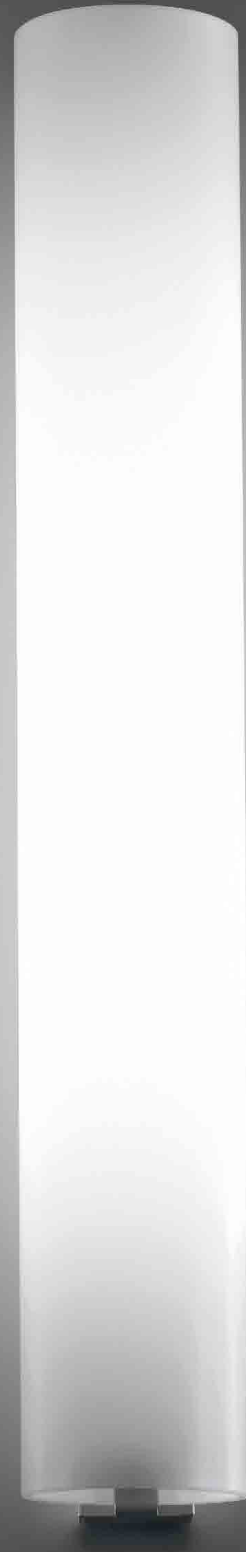

Sospensione / Suspension **STICK 100-150-240**

LL9610

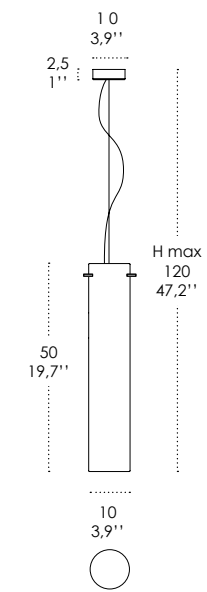

LL9710

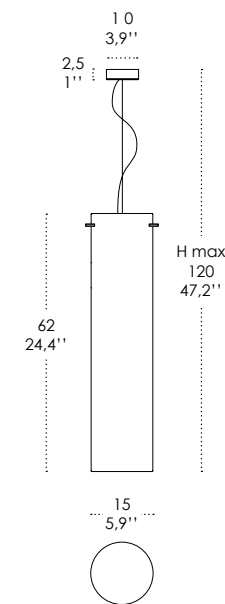

LL9821

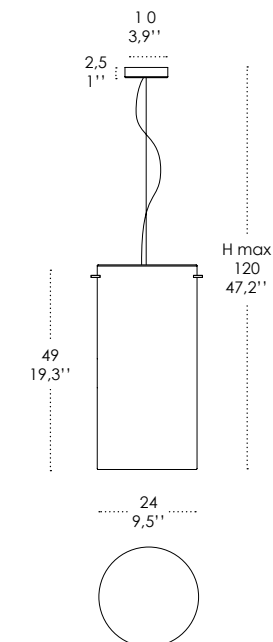

LL9827

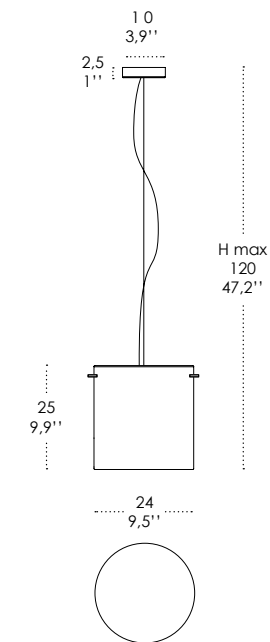

| E27 220-240V | | CE | |
|---------------|----------------|-----------------|-----------|
| CROMO CHROME | BIANCO WHITE | LAMP CONNECTION | WATT MAX |
| LL9610 | LL9610B | E27 | 1 x 70 HS |
| LL9710 | LL9710B | E27 | 1 x 70 HS |
| LL9821 | LL9821B | E27 | 1 x 70 HS |
| LL9827 | LL9827B | E27 | 1 x 70 HS |

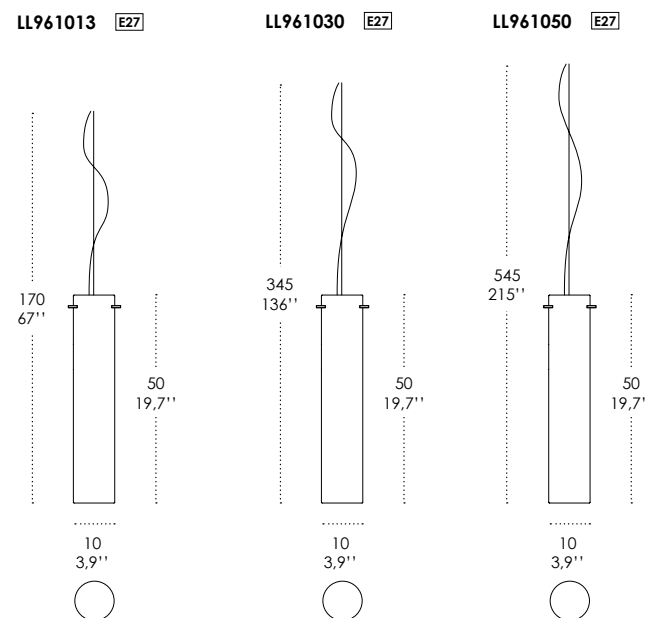

| E27 220-240V IP20 | | | CE |
|-------------------|-----------------|-----------|----|
| CROMO CHROME | LAMP CONNECTION | WATT MAX | |
| LL961013 | E27 | 1 x 70 HS | |
| LL961030 | E27 | 1 x 70 HS | |
| LL961050 | E27 | 1 x 70 HS | |

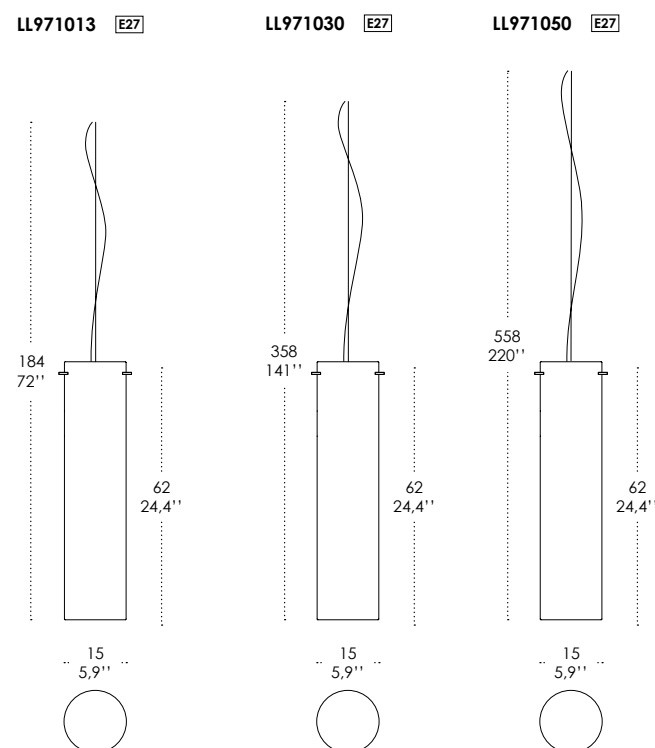

| E27 220-240V IP20 | | | CE |
|-------------------|-----------------|-----------|----|
| CROMO CHROME | LAMP CONNECTION | WATT MAX | |
| LL971013 | E27 | 1 x 70 HS | |
| LL971030 | E27 | 1 x 70 HS | |
| LL971050 | E27 | 1 x 70 HS | |

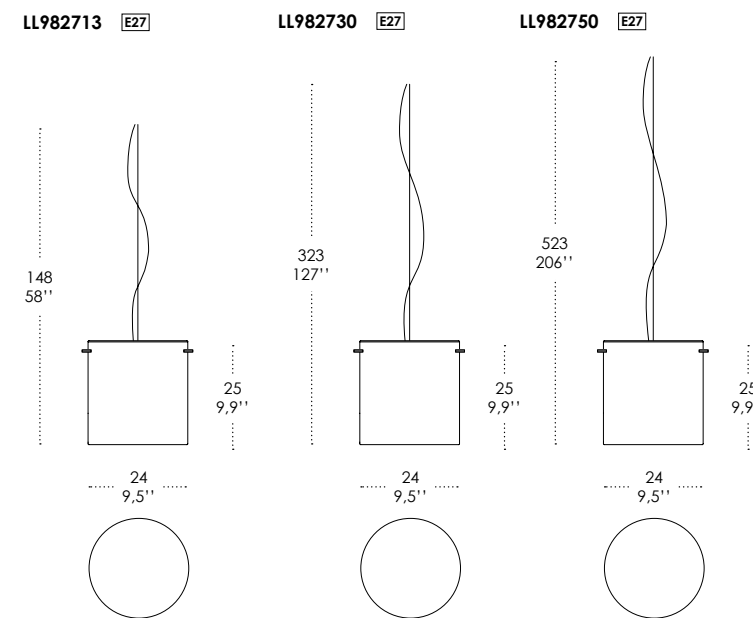

| E27 220-240V IP20 | | | CE |
|-------------------|-----------------|-----------|----|
| CROMO CHROME | LAMP CONNECTION | WATT MAX | |
| LL982713 | E27 | 1 x 70 HS | |
| LL982730 | E27 | 1 x 70 HS | |
| LL982750 | E27 | 1 x 70 HS | |

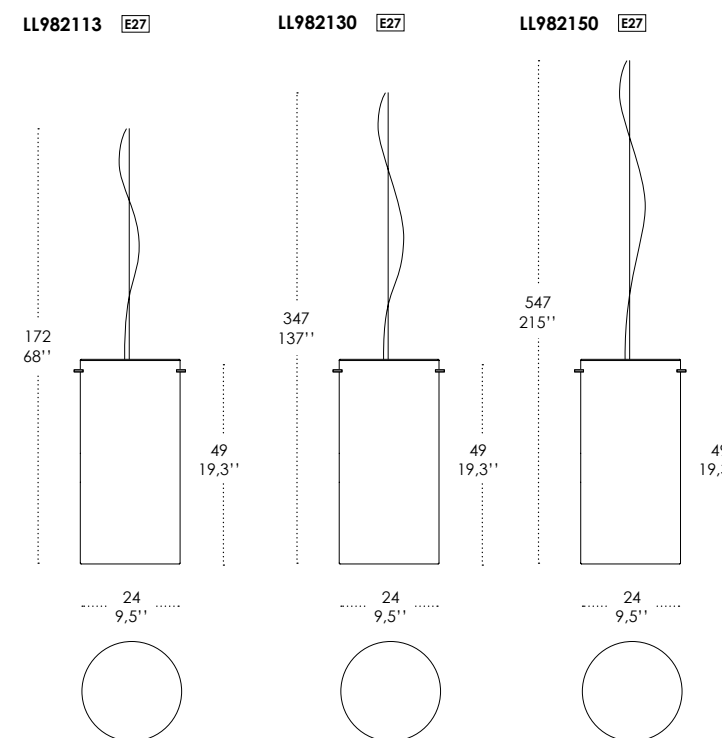

| E27 220-240V IP20 | | | CE |
|-------------------|-----------------|-----------|----|
| CROMO CHROME | LAMP CONNECTION | WATT MAX | |
| LL982113 | E27 | 1 x 70 HS | |
| LL982130 | E27 | 1 x 70 HS | |
| LL982150 | E27 | 1 x 70 HS | |

Rosone compatibile per sospensioni a 3 luci / Compatible canopy for hanging lamp 3 lights

LGR0066 grigio / grey LGR0076 bianco / white

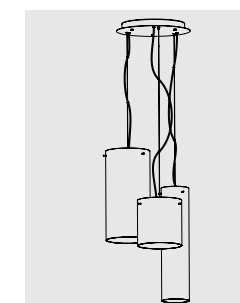
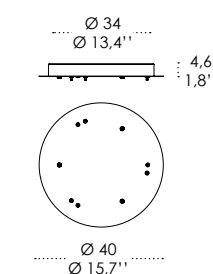

Esempio installazione
Example of installation

LL9511 **LD9511C3**

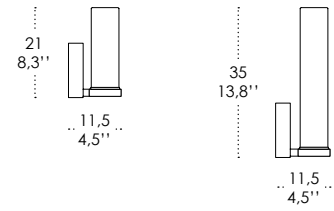

LD9517C3

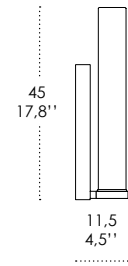

| E27 220-240V | | | CE |
|--------------|-----------------|-----------|----|
| CROMO CHROME | LAMP CONNECTION | WATT MAX | |
| LL9511 | E27 | 1 x 42 HS | |

| LED 3000K CRI≥90 | | | | | | | CE |
|------------------|--------|---------|---------|---------|-------------|------------|----|
| CROMO CHROME | WATT | TOTAL W | Lm LED | Lm LAMP | VOLTAGE | BEAM ANGLE | |
| LD9511C3 | 8,4 W | 9,6 W | 924 lm | 626 lm | 100 - 240 V | 360° | |
| LD9515C3 | 12,6 W | 15,2 W | 1386 lm | 1155 lm | 220 - 240 V | 360° | |
| LD9517C3 | 16,8 W | 18 W | 1848 lm | 1295 lm | 220 - 240 V | 360° | |

LD9591B3 **LD9592B3**

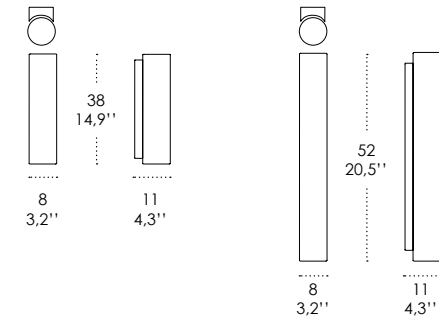

LD9593B3

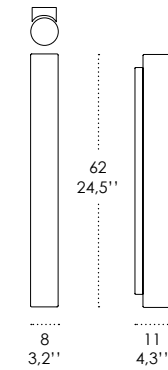

| LED DIMMER 3000K CRI≥90 220-240 | | | | | | | CE |
|----------------------------------|--------|---------|---------|---------|--------|------------|----|
| BIANCO WHITE | WATT | TOTAL W | Lm LED | Lm LAMP | DIMMER | BEAM ANGLE | |
| LD9591B3 | 12,6 W | 14,4 W | 1386 lm | 856 lm | TRIAC | 120° | |
| LD9592B3 | 15,8 W | 18 W | 1738 lm | 1217 lm | TRIAC | 120° | |
| LD9593B3 | 19 W | 27,5 W | 2079 lm | 1450 lm | TRIAC | 120° | |

Posizionamento sia verticale sia orizzontale. Con placca di chiusura per i lati aperti. **Vetro lucido.**
Vertical or horizontal. End plate for closing open sides. **Glossy glass.**

LL9521 **LD9521C3**

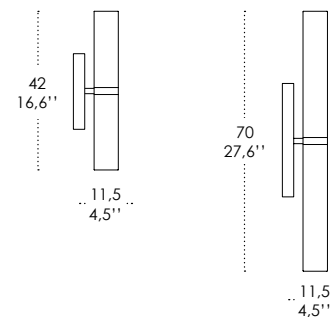

LD9527C3

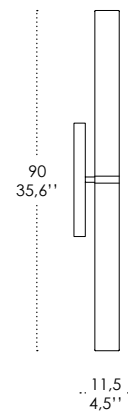

| E27 220-240V | | | CE |
|--------------|-----------------|-----------|----|
| CROMO CHROME | LAMP CONNECTION | WATT MAX | |
| LL9521 | E27 | 2 x 42 HS | |

| LED 3000K CRI≥90 | | | | | | | CE |
|------------------|------------|------------|-------------|-------------|-------------|------------|----|
| CROMO CHROME | WATT | TOTAL W | Lm LED | Lm LAMP | VOLTAGE | BEAM ANGLE | |
| LD9521C3 | 2 x 8,4 W | 2 x 9,6 W | 2 x 924 lm | 2 x 626 lm | 100 - 240 V | 360° | |
| LD9525C3 | 2 x 12,6 W | 2 x 15,2 W | 2 x 1386 lm | 2 x 1155 lm | 220 - 240 V | 360° | |
| LD9527C3 | 2 x 16,8 W | 2 x 18 W | 2 x 1848 lm | 2 x 1295 lm | 220 - 240 V | 360° | |

LD6501B3 **LD6502B3**

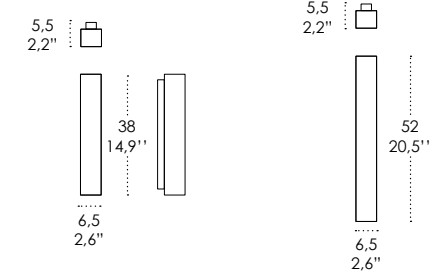

| LED DIMMER 3000K CRI≥90 220-240 | | | | | | | CE |
|----------------------------------|--------|---------|---------|---------|--------|------------|----|
| BIANCO WHITE | WATT | TOTAL W | Lm LED | Lm LAMP | DIMMER | BEAM ANGLE | |
| LD6501B3 | 12,6 W | 14,4 W | 1386 lm | 856 lm | TRIAC | 160° | |
| LD6502B3 | 15,8 W | 18 W | 1738 lm | 1217 lm | TRIAC | 160° | |

Posizionamento sia verticale sia orizzontale. Con placca di chiusura per i lati aperti.
Vertical or horizontal. End plate for closing open sides.

SPICCHIO



Lampada da parete con diffusore in vetro triplex opale satinato soffiato a bocca, struttura in metallo verniciato bianco e dettagli cromati. Il prodotto è adatto esclusivamente all'uso interno.

Wall lamp with diffuser in mouth-blown, satin-finish opal triplex glass; matt white painted metal frame with chromed details. The product is suitable for indoor use only.

Parete / Wall

LED 2700K - 4000K su richiesta / on request

LL5001
LD5000

E14

LED

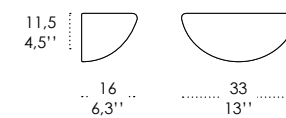

| E14 220-240V IP20 | | | CE |
|-------------------|-----------------|-----------|----|
| COD. | LAMP CONNECTION | WATT MAX | |
| LL5001 | 2 x E14 | 2 x 42 HS | |

| LED 3000K CRI>80 220-240V IP20 | | | | | CE |
|--------------------------------|-------|---------|---------|---------|------------|
| COD. | WATT | TOTAL W | lm LED | lm LAMP | BEAM ANGLE |
| LD5000 | 8,7 W | 10 W | 1310 lm | 480 lm | 130° |

CHIUSA

DESIGN_Federico de Majo

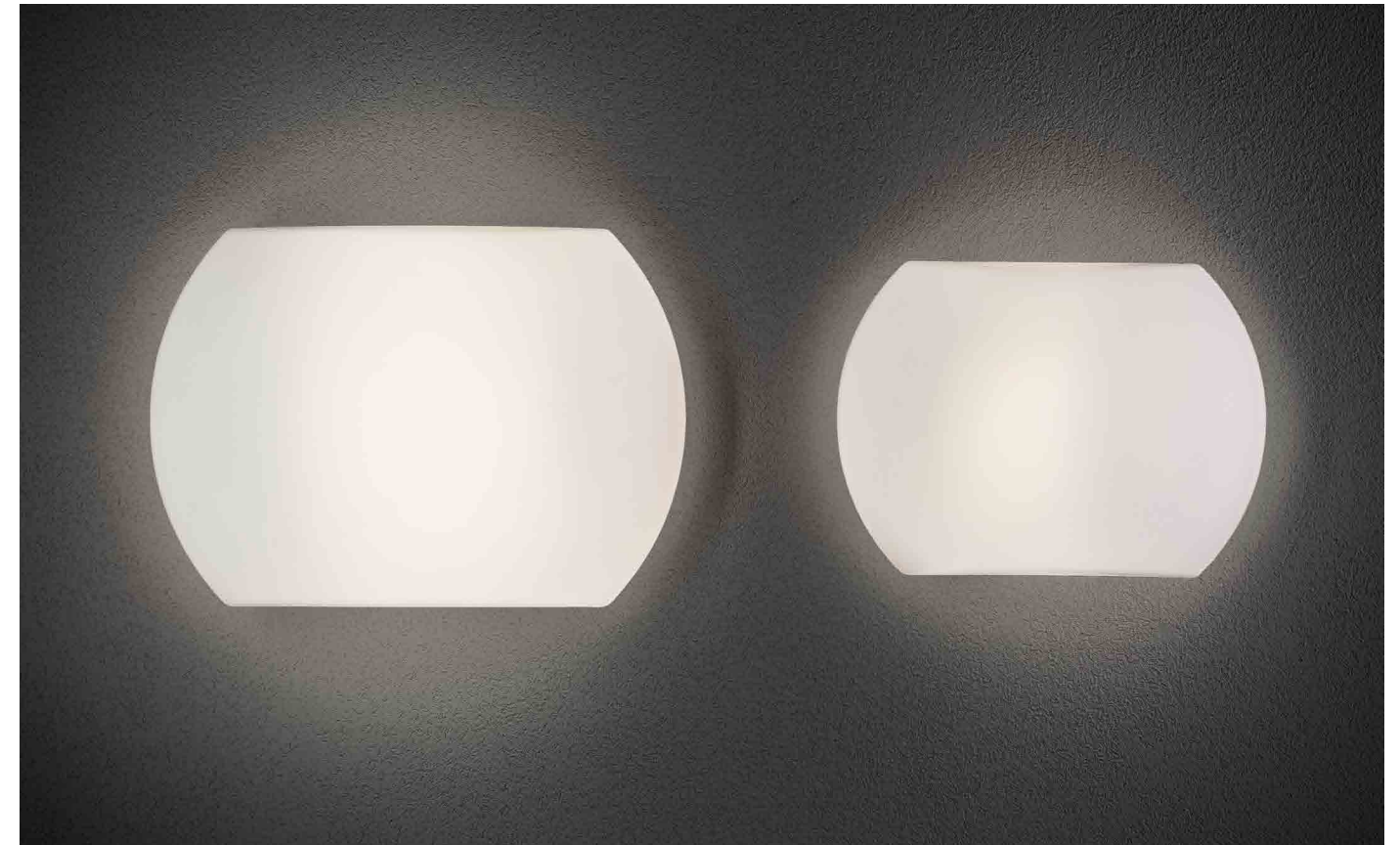



Bianco
White

Lampade da parete-soffitto con diffusore in vetro triplex opale satinato soffiato a bocca, e struttura in metallo verniciato bianco opaco. Il prodotto è adatto esclusivamente all'uso interno.

Wall-ceiling lamps with diffuser in mouth-blown, satin-finish opal triplex glass; matt white painted metal frame. The product is suitable for indoor use only.

Parete-soffitto / Wall-ceiling



LED 2700K - 4000K su richiesta / on request

LL5500 
LD550003 

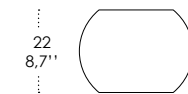
11
4,4"





30
11,8"

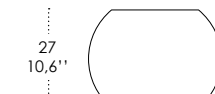

LL5501 
LD550103 

13
5,1"



37
14,6"

| E27 220-240V   | | | CE |
|------------------------------------------------------------------------------------------------------------------------------------------------------------------------------------------|-----------------|-----------|----|
| COD. | LAMP CONNECTION | WATT MAX | |
| LL5500 | E27 | 1 x 42 HS | |
| LL5501 | E27 | 2 x 42 HS | |

| LED 3000K CRI>80 220-240V   | | | | | | CE |
|-------------------------------------------------------------------------------------------------------------------------------------------------------------------------------------------------------|--------|---------|---------|---------|------------|----|
| COD. | WATT | TOTAL W | Lm LED | Lm LAMP | BEAM ANGLE | |
| LD550003 | 8,7 W | 10 W | 1310 lm | 480 lm | 130° | |
| LD550103 | 17,4 W | 20 W | 2620 lm | 960 lm | 130° | |

DRUM

Attacco a baionetta / Twist-lock coupling



NE - N3
Trasparente
Clear



Attacco a baionetta
Twist-lock coupling

Lampade da parete-soffitto con diffusore in vetro triplex opale satinato soffiato a bocca, e struttura in policarbonato anti UV traslucido neutro resistente al cloro. Chiusura del vetro a baionetta. Il prodotto è adatto esclusivamente all'uso interno; il grado di protezione IP44 lo rende particolarmente indicato per piscine e ambienti umidi in genere.

Wall-ceiling lamps with diffuser in mouth-blown, satin-finish opal triplex glass; chlorine-resistant, anti-UV, neutral translucent polycarbonate frame. Twist-lock coupling system for the glass component. The product is suitable for indoor use only; the IP44 rating makes it ideal for use in swimming pools and humid environments in general.

Parete-soffitto / Wall-ceiling

LED 2700K - 4000K su richiesta / on request

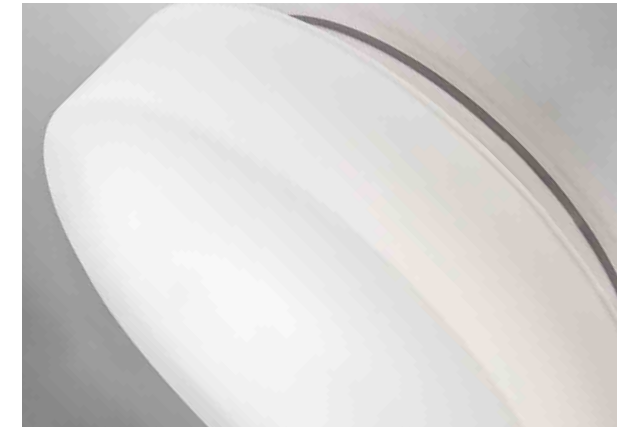

LL8701 E27
LD8701 LED
LD870113 LED TRIAC
LD870123 LED DALI
LD870133 LED WI-FI

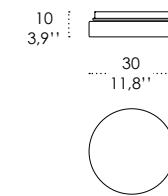

LL8731 E27
LD8731 LED
LD873113 LED TRIAC
LD873123 LED DALI
LD873133 LED WI-FI
LD8742 LED EMERGENCY

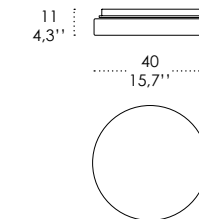

LL8761 E27
LD8761 LED
LD876113 LED TRIAC
LD876123 LED DALI
LD876133 LED WI-FI
LD8772 LED EMERGENCY

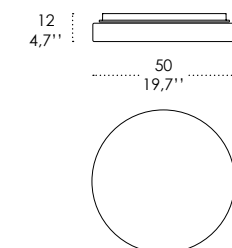

| E27 220-240V IP44 | | | | | | CE |
|-------------------|----------|-----------------|-----------|--|--|----|
| COD. | FINISHES | LAMP CONNECTION | WATT MAX | | | |
| LL8701 | NE | E27 | 1 x 42 HS | | | |
| LL8731 | NE | E27 | 2 x 42 HS | | | |
| LL8761 | NE | E27 | 3 x 42 HS | | | |

| LED 3000K CRI≥90 220-240V IP44 | | | | | | | CE |
|--------------------------------|----------|--------|---------|---------|---------|------------|----|
| COD. | FINISHES | WATT | TOTAL W | Lm LED | Lm LAMP | BEAM ANGLE | |
| LD8701 | N3 | 10,5 W | 12,5 W | 1350 lm | 1110 lm | 130° | |
| LD8731 | N3 | 17 W | 18,5 W | 2200 lm | 1510 lm | 130° | |
| LD8761 | N3 | 27,5 W | 29 W | 3450 lm | 2070 lm | 130° | |

| LED DIMMER 3000K CRI≥90 220-240V IP44 | | | | | | | | CE |
|---------------------------------------|----------|--------|---------|---------|---------|------------|--------|----|
| COD. | FINISHES | WATT | TOTAL W | Lm LED | Lm LAMP | BEAM ANGLE | DIMMER | |
| LD870113 | N3 | 10,5 W | 12,5 W | 1350 lm | 1110 lm | 130° | TRIAC | |
| LD870123 | N3 | 10,5 W | 12,5 W | 1350 lm | 1110 lm | 130° | DALI | |
| LD870133 | N3 | 10,5 W | 12,5 W | 1350 lm | 1110 lm | 130° | WI-FI | |
| LD873113 | N3 | 17 W | 18,5 W | 2200 lm | 1510 lm | 130° | TRIAC | |
| LD873123 | N3 | 17 W | 18,5 W | 2200 lm | 1510 lm | 130° | DALI | |
| LD873133 | N3 | 17 W | 18,5 W | 2200 lm | 1510 lm | 130° | WI-FI | |
| LD876113 | N3 | 27,5 W | 29 W | 3450 lm | 2070 lm | 130° | TRIAC | |
| LD876123 | N3 | 27,5 W | 29 W | 3450 lm | 2070 lm | 130° | DALI | |
| LD876133 | N3 | 27,5 W | 29 W | 3450 lm | 2070 lm | 130° | WI-FI | |

| LED EMERGENCY 3000K CRI≥90 220-240V IP44 | | | | | | | CE |
|------------------------------------------|----------|--------|------------|---------|---------------|------------|----|
| COD. | FINISHES | WATT | TOTAL W | Lm LED | Lm LAMP | BEAM ANGLE | |
| LD8742 | N3 | 17 W | 5 - 18,5 W | 2200 lm | 475 - 1510 lm | 130° | |
| LD8772 | N3 | 27,5 W | 5 - 29 W | 3450 lm | 370 - 2070 lm | 130° | |

Versione con dispositivo di emergenza integrato, con autonomia di 3 ore.
Version with integrated emergency device, with autonomy of 3 hours.

DRUM METAL

Attacco a baionetta / Twist-lock coupling



C - C3
Cromo
Chrome



B - B3
Bianco
White



Attacco a baionetta
Twist-lock coupling

Lampade da parete-soffitto con diffusore in vetro triplex opale satinato soffiato a bocca, e struttura in policarbonato anti UV traslucido neutro resistente al cloro e bordato in metallo cromato o verniciato bianco opaco. Chiusura del vetro a baionetta. Il prodotto è adatto esclusivamente all'uso interno; il grado di protezione IP44 lo rende particolarmente indicato per piscine e ambienti umidi in genere.

Wall-ceiling lamps with diffuser in mouth-blown, satin-finish opal triplex glass; chlorine-resistant, anti-UV, neutral translucent polycarbonate frame, with chrome or matt white painted metal parts. Twist-lock coupling system for the glass component. The product is suitable for indoor use only. The IP44 rating makes it ideal for use in swimming pools and humid environments in general.

Parete-soffitto / Wall-ceiling

LED 2700K - 4000K su richiesta / on request

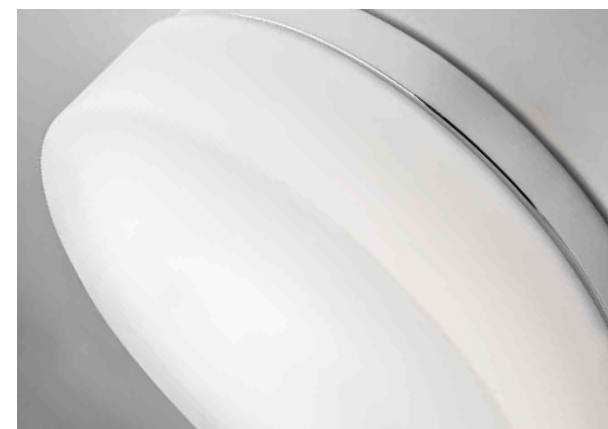

| E27 220-240V IP44 | | | | | CE |
|-------------------|----------|-----------------|-----------|--|----|
| COD. | FINISHES | LAMP CONNECTION | WATT MAX | | |
| LL8701 | C - B | E27 | 1 x 42 HS | | |
| LL8731 | C - B | E27 | 2 x 42 HS | | |
| LL8761 | C - B | E27 | 3 x 42 HS | | |

| LED 3000K CRI≥90 220-240V IP44 | | | | | | | CE |
|--------------------------------|----------|--------|---------|---------|---------|------------|----|
| COD. | FINISHES | WATT | TOTAL W | Lm LED | Lm LAMP | BEAM ANGLE | |
| LD8701 | C3 - B3 | 10,5 W | 12,5 W | 1350 lm | 1110 lm | 130° | |
| LD8731 | C3 - B3 | 17 W | 18,5 W | 2200 lm | 1510 lm | 130° | |
| LD8761 | C3 - B3 | 27,5 W | 29 W | 3450 lm | 2070 lm | 130° | |

- LL8701 E27
- LD8701 LED
- LD870113 LED TRIAC
- LD870123 LED DALI
- LD870133 LED WI-FI

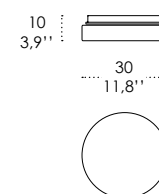

- LL8731 E27
- LD8731 LED
- LD873113 LED TRIAC
- LD873123 LED DALI
- LD873133 LED WI-FI
- LD8743 LED EMERGENCY

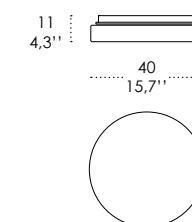

- LL8761 E27
- LD8761 LED
- LD876113 LED TRIAC
- LD876123 LED DALI
- LD876133 LED WI-FI
- LD8745 LED EMERGENCY

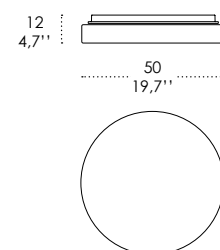

| LED DIMMER 3000K CRI≥90 220-240V IP44 | | | | | | | | CE |
|---------------------------------------|----------|--------|---------|---------|---------|------------|--------|----|
| COD. | FINISHES | WATT | TOTAL W | Lm LED | Lm LAMP | BEAM ANGLE | DIMMER | |
| LD870113 | C3 - B3 | 10,5 W | 12,5 W | 1350 lm | 1110 lm | 130° | TRIAC | |
| LD870123 | C3 - B3 | 10,5 W | 12,5 W | 1350 lm | 1110 lm | 130° | DALI | |
| LD870133 | C3 - B3 | 10,5 W | 12,5 W | 1350 lm | 1110 lm | 130° | WI-FI | |
| LD873113 | C3 - B3 | 17 W | 18,5 W | 2200 lm | 1510 lm | 130° | TRIAC | |
| LD873123 | C3 - B3 | 17 W | 18,5 W | 2200 lm | 1510 lm | 130° | DALI | |
| LD873133 | C3 - B3 | 17 W | 18,5 W | 2200 lm | 1510 lm | 130° | WI-FI | |
| LD876113 | C3 - B3 | 27,5 W | 29 W | 3450 lm | 2070 lm | 130° | TRIAC | |
| LD876123 | C3 - B3 | 27,5 W | 29 W | 3450 lm | 2070 lm | 130° | DALI | |
| LD876133 | C3 - B3 | 27,5 W | 29 W | 3450 lm | 2070 lm | 130° | WI-FI | |

| LED EMERGENCY 3000K CRI≥90 220-240V IP44 | | | | | | | CE |
|------------------------------------------|----------|--------|------------|---------|---------------|------------|----|
| COD. | FINISHES | WATT | TOTAL W | Lm LED | Lm LAMP | BEAM ANGLE | |
| LD8743 | C3 - B3 | 17 W | 5 - 18,5 W | 2200 lm | 475 - 1510 lm | 130° | |
| LD8745 | C3 - B3 | 27,5 W | 5 - 29 W | 3450 lm | 370 - 2070 lm | 130° | |

Versione con dispositivo di emergenza integrato, con autonomia di 3 ore.
Version with integrated emergency device, with autonomy of 3 hours.

DRUM BAYONET

Attacco a baionetta / Twist-lock coupling



Bianco
White

Lampade da parete-soffitto con diffusore in vetro triplex opale satinato soffiato a bocca, e struttura in metallo verniciato bianco.
Chiusura del vetro a baionetta.
Il prodotto è adatto esclusivamente all'uso interno.

Wall-ceiling lamps with diffuser in mouth-blown, satin-finish opal triplex glass, and white painted metal frame.
Twist-lock system for the glass component.
The product is suitable for indoor use only.

Parete-soffitto / Wall-ceiling

LED 2700K - 4000K su richiesta / on request

LL8910 E27
LD891003 LED
LD891013 LED TRIAC
LD891023 LED DALI
LD891033 LED WI-FI

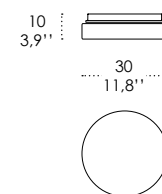

LL8911 E27
LD891103 LED
LD891113 LED TRIAC
LD891123 LED DALI
LD891133 LED WI-FI
LD894103 LED EMERGENCY

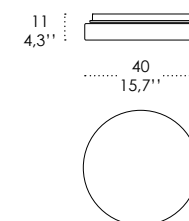

LL8912 E27
LD891203 LED
LD891213 LED TRIAC
LD891223 LED DALI
LD891233 LED WI-FI
LD894203 LED EMERGENCY

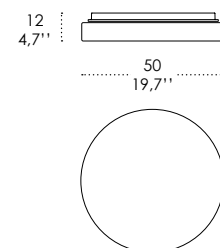

LL8913 E27
LD891303 LED

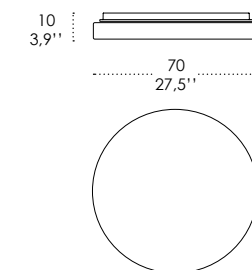

| E27 220-240V IP20 | | | CE |
|-------------------|-----------------|-----------|----|
| COD. | LAMP CONNECTION | WATT MAX | |
| LL8910 | E27 | 1 x 52 HS | |
| LL8911 | E27 | 2 x 52 HS | |
| LL8912 | E27 | 3 x 52 HS | |
| LL8913 | E27 | 5 x 52 HS | |

| LED 3000K 220-240V IP20 | | | | | | | CE |
|-------------------------|--------|---------|---------|---------|------------|-----|----|
| COD. | WATT | TOTAL W | Lm LED | Lm LAMP | BEAM ANGLE | CRI | |
| LD891003 | 10,5 W | 12,5 W | 1350 lm | 1110 lm | 130° | ≥90 | |
| LD891103 | 17 W | 18,5 W | 2200 lm | 1510 lm | 130° | ≥90 | |
| LD891203 | 27,5 W | 29 W | 3450 lm | 2070 lm | 130° | ≥90 | |
| LD891303 | 67 W | 70 W | 7200 lm | 5060 lm | 130° | >80 | |

| LED DIMMER 3000K CRI≥90 220-240V IP20 | | | | | | | CE |
|---------------------------------------|--------|---------|---------|---------|------------|--------|----|
| COD. | WATT | TOTAL W | Lm LED | Lm LAMP | BEAM ANGLE | DIMMER | |
| LD891013 | 10,5 W | 12,5 W | 1350 lm | 1110 lm | 130° | TRIAC | |
| LD891023 | 10,5 W | 12,5 W | 1350 lm | 1110 lm | 130° | DALI | |
| LD891033 | 10,5 W | 12,5 W | 1350 lm | 1110 lm | 130° | WI-FI | |
| LD891113 | 17 W | 18,5 W | 2200 lm | 1510 lm | 130° | TRIAC | |
| LD891123 | 17 W | 18,5 W | 2200 lm | 1510 lm | 130° | DALI | |
| LD891133 | 17 W | 18,5 W | 2200 lm | 1510 lm | 130° | WI-FI | |
| LD891213 | 27,5 W | 29 W | 3450 lm | 2070 lm | 130° | TRIAC | |
| LD891223 | 27,5 W | 29 W | 3450 lm | 2070 lm | 130° | DALI | |
| LD891233 | 27,5 W | 29 W | 3450 lm | 2070 lm | 130° | WI-FI | |

| LED EMERGENCY 3000K CRI≥90 220-240V IP20 | | | | | | CE |
|------------------------------------------|--------|------------|---------|---------------|------------|----|
| COD. | WATT | TOTAL W | Lm LED | Lm LAMP | BEAM ANGLE | |
| LD894103 | 17 W | 5 - 18,5 W | 2200 lm | 475 - 1510 lm | 130° | |
| LD894203 | 27,5 W | 5 - 29 W | 3450 lm | 370 - 2070 lm | 130° | |

Versione con dispositivo di emergenza integrato, con autonomia di 3 ore.
Version with integrated emergency device, with autonomy of 3 hours.

BIS

Attacco a baionetta / Twist-lock coupling



NE
Trasparente
Clear

Lampade da parete-soffitto con diffusore in vetro triplex opale satinato soffiato a bocca, e struttura in policarbonato anti UV traslucido neutro resistente al cloro.
Chiusura del vetro a baionetta.
Il prodotto è adatto esclusivamente all'uso interno; il grado di protezione IP44, lo rende indicato per piscine e ambienti umidi in genere.

Wall-ceiling lamps with diffuser in mouth-blown, satin-finish opal triplex glass; chlorine-resistant, anti-UV, neutral translucent polycarbonate frame.
Twist-lock system for the glass component.
The product is suitable for indoor use only.
The IP44 rating makes it ideal for use in swimming pools and humid environments in general.

Parete-soffitto / Wall-ceiling

LED 2700K - 4000K su richiesta / on request

LL6111 E27
LD6111 LED
LD611113 LED TRIAC
LD611123 LED DALI
LD611133 LED WI-FI

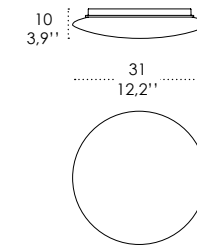

LL6112 E27
LD6112 LED
LD611213 LED TRIAC
LD611223 LED DALI
LD611233 LED WI-FI
LD612603 LED EMERGENCY

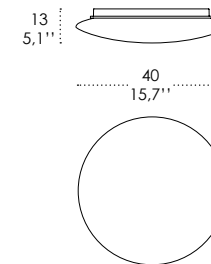

LL6113 E27
LD6113 LED
LD611313 LED TRIAC
LD611323 LED DALI
LD611333 LED WI-FI
LD612703 LED EMERGENCY

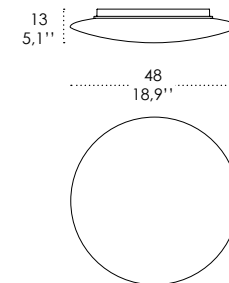

| E27 220-240V IP44 | | | CE |
|-------------------|----------|-----------|----|
| COD. | FINISHES | WATT MAX | |
| LL6111 | NE | 1 x 42 HS | |
| LL6112 | NE | 2 x 42 HS | |
| LL6113 | NE | 3 x 42 HS | |

| LED 3000K CRI≥90 220-240V IP44 | | | | | | | CE |
|--------------------------------|----------|--------|--------|---------|---------|------------|----|
| COD. | FINISHES | POWER | TOTAL | lm LED | lm LAMP | BEAM ANGLE | |
| LD6111 | NE | 10,5 W | 12,5 W | 1350 lm | 1110 lm | 130° | |
| LD6112 | NE | 17 W | 18,5 W | 2200 lm | 1510 lm | 130° | |
| LD6113 | NE | 27,5 W | 29 W | 3450 lm | 2070 lm | 130° | |

| LED DIMMER 3000K CRI≥90 220-240V IP44 | | | | | | | | CE |
|---------------------------------------|----------|--------|--------|---------|---------|------------|--------|----|
| COD. | FINISHES | POWER | TOTAL | lm LED | lm LAMP | BEAM ANGLE | DIMMER | |
| LD611113 | NE | 10,5 W | 12,5 W | 1350 lm | 1110 lm | 130° | TRIAC | |
| LD611123 | NE | 10,5 W | 12,5 W | 1350 lm | 1110 lm | 130° | DALI | |
| LD611133 | NE | 10,5 W | 12,5 W | 1350 lm | 1110 lm | 130° | WI-FI | |
| LD611213 | NE | 17 W | 18,5 W | 2200 lm | 1510 lm | 130° | TRIAC | |
| LD611223 | NE | 17 W | 18,5 W | 2200 lm | 1510 lm | 130° | DALI | |
| LD611233 | NE | 17 W | 18,5 W | 2200 lm | 1510 lm | 130° | WI-FI | |
| LD611313 | NE | 27,5 W | 29 W | 3450 lm | 2070 lm | 130° | TRIAC | |
| LD611323 | NE | 27,5 W | 29 W | 3450 lm | 2070 lm | 130° | DALI | |
| LD611333 | NE | 27,5 W | 29 W | 3450 lm | 2070 lm | 130° | WI-FI | |

| LED EMERGENCY 3000K CRI≥90 220-240V IP44 | | | | | | | CE |
|------------------------------------------|----------|--------|------------|---------|---------------|------------|----|
| COD. | FINISHES | POWER | TOTAL | lm LED | lm LAMP | BEAM ANGLE | |
| LD612603 | NE | 17 W | 5 - 18,5 W | 2200 lm | 475 - 1510 lm | 130° | |
| LD612703 | NE | 27,5 W | 5 - 29 W | 3450 lm | 370 - 2070 lm | 130° | |

Versione con dispositivo di emergenza integrato, con autonomia di 3 ore.
Version with integrated emergency device, with autonomy of 3 hours.

BIS BAYONET

Attacco a baionetta / Twist-lock coupling

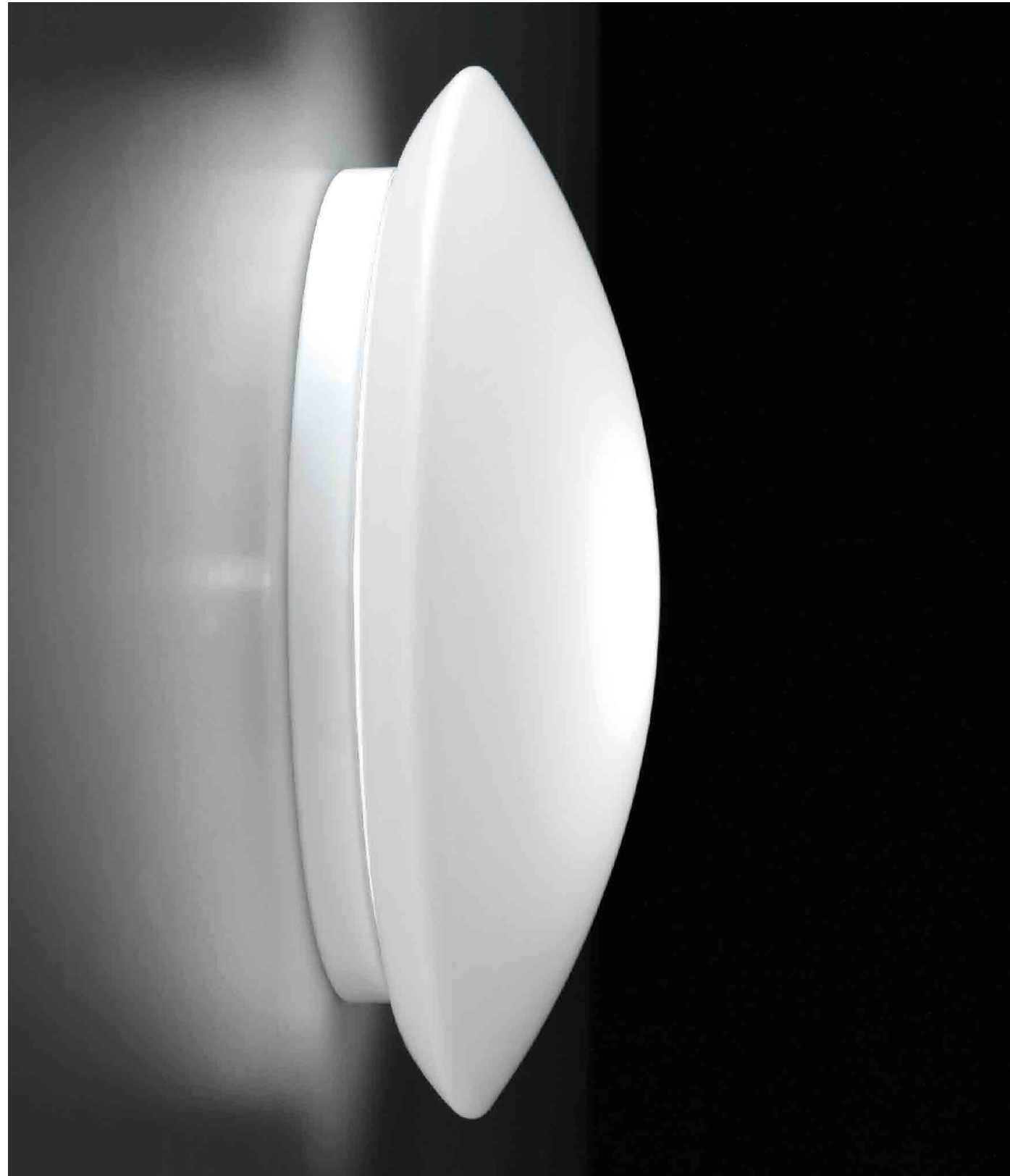

Bianco
White

Lampade da parete-soffitto con diffusore in vetro triplex opale satinato soffiato a bocca, e struttura in metallo verniciato bianco.
Chiusura del vetro a baionetta.
Il prodotto è adatto esclusivamente all'uso interno.

Wall-ceiling lamps with diffuser in mouth-blown, satin-finish opal triplex glass; white painted metal frame.
Twist-lock system for the glass component.
The product is suitable for indoor use only.

Parete-soffitto / Wall-ceiling

LED 2700K - 4000K su richiesta / on request

LL6110 E27
LD611003 LED

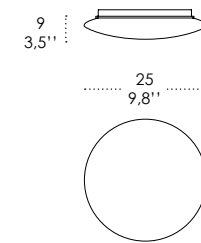

LL6111 E27
LD611103 LED
LD611113 LED TRIAC
LD611123 LED DALI
LD611133 LED WI-FI

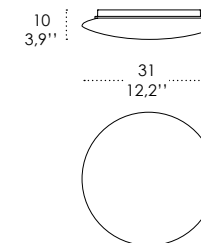

LL6112 E27
LD611203 LED
LD611213 LED TRIAC
LD611223 LED DALI
LD611233 LED WI-FI
LD612603 LED EMERGENCY

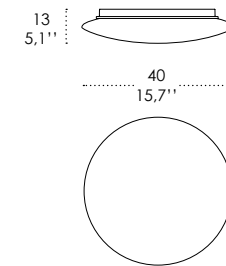

LL6113 E27
LD611303 LED
LD611313 LED TRIAC
LD611323 LED DALI
LD611333 LED WI-FI
LD612703 LED EMERGENCY

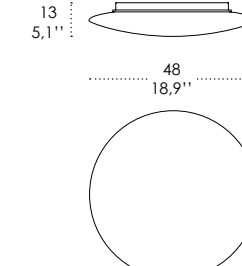

| E27 220-240V IP20 | | CE |
|-------------------|-----------|----|
| COD. | WATT MAX | |
| LL6110 | 1 x 42 HS | |
| LL6111 | 1 x 52 HS | |
| LL6112 | 2 x 52 HS | |
| LL6113 | 3 x 52 HS | |

| LED 3000K 220-240V IP20 | | | | | | | CE |
|-------------------------|--------|---------|---------|---------|------------|-----|----|
| COD. | WATT | TOTAL W | Lm LED | Lm LAMP | BEAM ANGLE | CRI | |
| LD611103 | 10,5 W | 12,5 W | 1350 lm | 1110 lm | 130° | ≥90 | |
| LD611203 | 17 W | 18,5 W | 2200 lm | 1510 lm | 130° | ≥90 | |
| LD611303 | 27,5 W | 29 W | 3450 lm | 2070 lm | 130° | ≥90 | |
| LD611003 | 8,7 W | 10 W | 1310 lm | 480 lm | 130° | >80 | |

| LED DIMMER 3000K CRI≥90 220-240V IP20 | | | | | | | CE |
|---------------------------------------|--------|---------|---------|---------|--------|------------|----|
| COD. | WATT | TOTAL W | Lm LED | Lm LAMP | DIMMER | BEAM ANGLE | |
| LD611113 | 10,5 W | 12,5 W | 1350 lm | 1110 lm | TRIAC | 130° | |
| LD611123 | 10,5 W | 12,5 W | 1350 lm | 1110 lm | DALI | 130° | |
| LD611133 | 10,5 W | 12,5 W | 1350 lm | 1110 lm | WI-FI | 130° | |
| LD611213 | 17 W | 18,5 W | 2200 lm | 1510 lm | TRIAC | 130° | |
| LD611223 | 17 W | 18,5 W | 2200 lm | 1510 lm | DALI | 130° | |
| LD611233 | 17 W | 18,5 W | 2200 lm | 1510 lm | WI-FI | 130° | |
| LD611313 | 27,5 W | 29 W | 3450 lm | 2070 lm | TRIAC | 130° | |
| LD611323 | 27,5 W | 29 W | 3450 lm | 2070 lm | TRIAC | 130° | |
| LD611333 | 27,5 W | 29 W | 3450 lm | 2070 lm | WI-FI | 130° | |

| LED EMERGENCY 3000K CRI≥90 220-240V IP20 | | | | | | CE |
|------------------------------------------|--------|------------|---------|---------------|------------|----|
| COD. | WATT | TOTAL W | Lm LED | Lm LAMP | BEAM ANGLE | |
| LD612603 | 17 W | 5 - 18,5 W | 2200 lm | 475 - 1510 lm | 130° | |
| LD612703 | 27,5 W | 5 - 29 W | 3450 lm | 370 - 2070 lm | 130° | |

Versione con dispositivo di emergenza integrato, con autonomia di 3 ore.
Version with integrated emergency device, with autonomy of 3 hours.

BOX ROTONDA

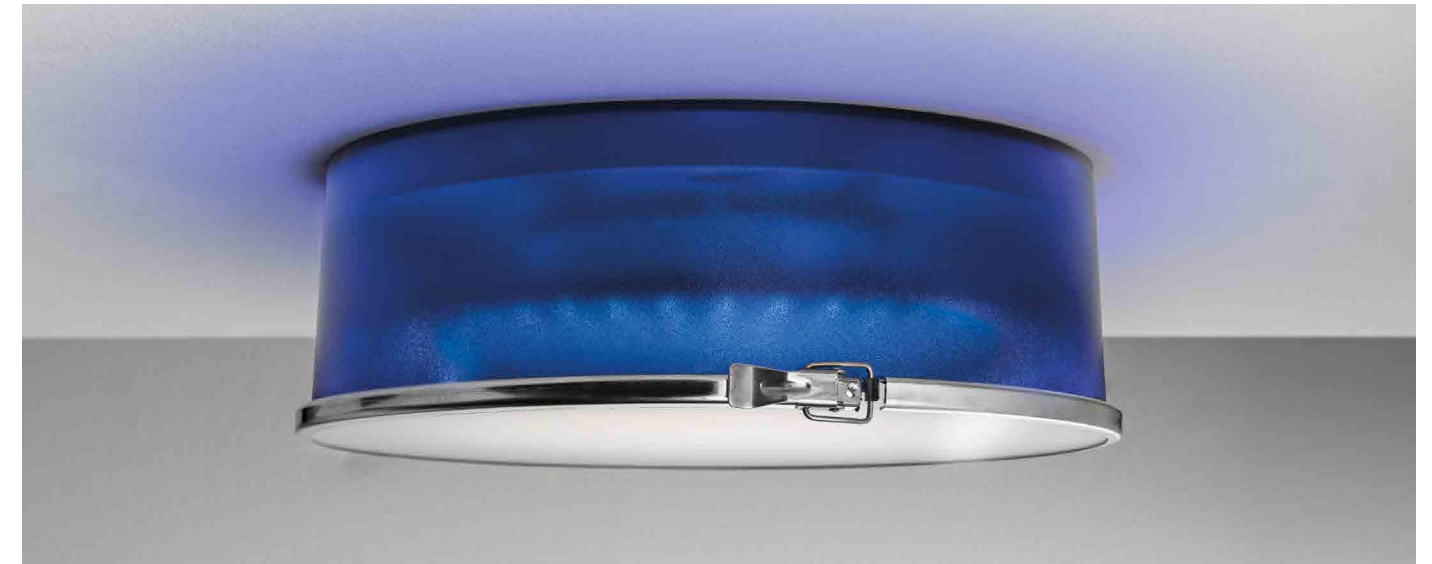

Lampada da parete-soffitto con diffusore in vetro extrachiaro satinato, e struttura in policarbonato anti UV traslucido neutro resistente al cloro con dettagli in acciaio inox, disponibile nei colori trasparente, rosso, arancione, blu, verde e giallo. Il prodotto è adatto esclusivamente all'uso interno.

Wall-ceiling lamp with diffuser in satin-finish extra clear glass and a chlorine-resistant, anti-UV, neutral translucent polycarbonate frame, with inox steel details, available in various colours: transparent, red, orange, blue, green or yellow. The product is suitable for indoor use only.

Parete-soffitto / Wall-ceiling

LED 2700K - 4000K su richiesta / on request

- LL8411
- LD8411
- LD8421
- LD8431
- LD8441

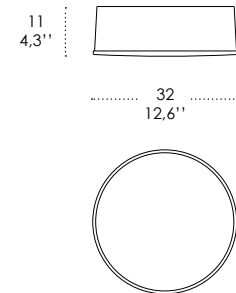

| E27 220-240V | | | | CE |
|--------------|------------------------------|-----------------|-----------|----|
| COD. | FINISHES | LAMP CONNECTION | WATT MAX | |
| LL8411 | NE - RO - AR BL - VE - GI | E27 | 2 x 42 HS | |

| LED 3000K CRI>90 220-240V | | | | | | | CE |
|---------------------------|------------------------------------|------|---------|---------|---------|------------|----|
| COD. | FINISHES | WATT | TOTAL W | Lm LED | Lm LAMP | BEAM ANGLE | |
| LD8411 | NE3 - RO3 - AR3 BL3 - VE3 - GI3 | 17 W | 18,5 W | 2200 lm | 1510 lm | 120° | |

| LED DIMMER 3000K CRI>90 220-240V | | | | | | | | CE |
|-----------------------------------|------------------------------------|------|---------|---------|---------|--------|------------|----|
| COD. | FINISHES | WATT | TOTAL W | Lm LED | Lm LAMP | DIMMER | BEAM ANGLE | |
| LD8421 | NE3 - RO3 - AR3 BL3 - VE3 - GI3 | 17 W | 18,5 W | 2200 lm | 1510 lm | TRIAC | 120° | |
| LD8431 | NE3 - RO3 - AR3 BL3 - VE3 - GI3 | 17 W | 18,5 W | 2200 lm | 1510 lm | DALI | 120° | |
| LD8441 | NE3 - RO3 - AR3 BL3 - VE3 - GI3 | 17 W | 18,5 W | 2200 lm | 1510 lm | WI-FI | 120° | |

BOX QUADRATA

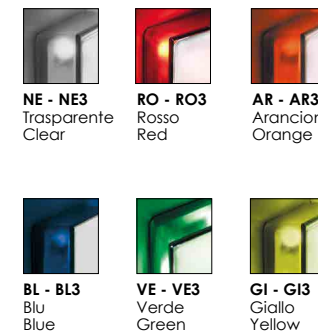
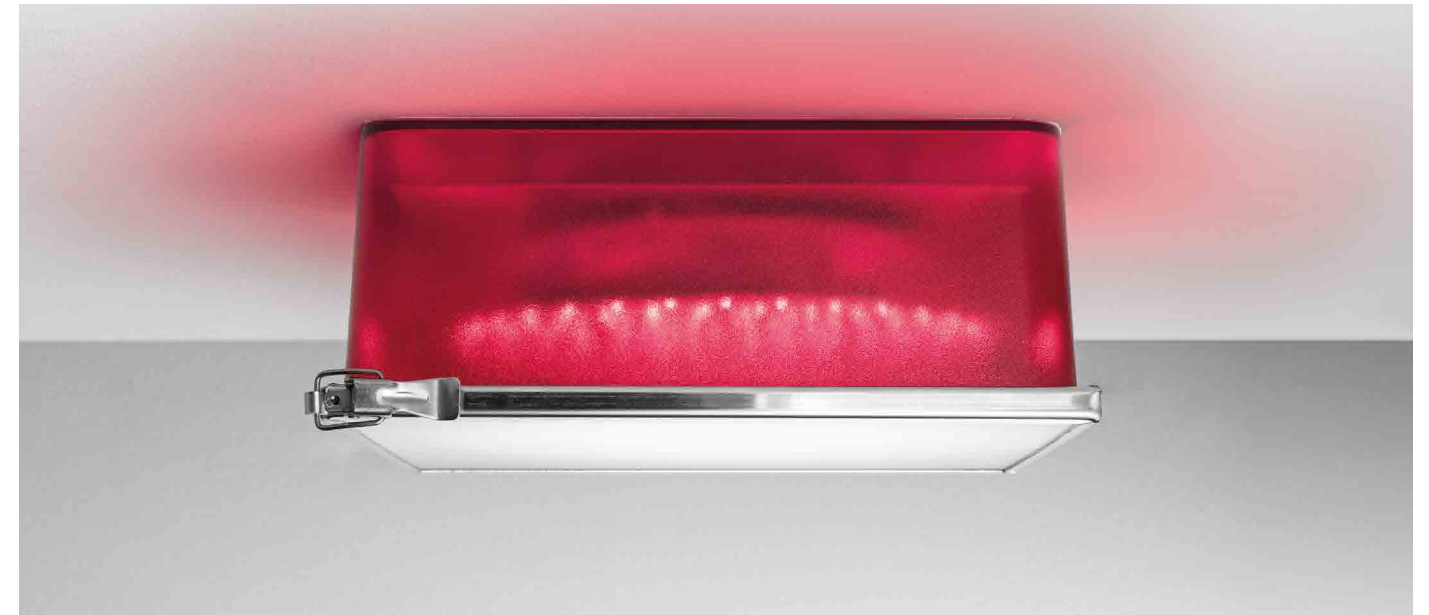

Lampada da parete-soffitto con diffusore in vetro extrachiaro satinato, e struttura in policarbonato anti UV traslucido neutro resistente al cloro con dettagli in acciaio inox, disponibile nei colori trasparente, rosso, arancione, blu, verde e giallo. Il prodotto è adatto esclusivamente all'uso interno.

Wall-ceiling lamp with diffuser in satin-finish extra clear glass and a chlorine-resistant, anti-UV, neutral translucent polycarbonate frame, with inox steel details, available in various colours: transparent, red, orange, blue, green or yellow. The product is suitable for indoor use only.

Parete-soffitto / Wall-ceiling

LED 2700K - 4000K su richiesta / on request

- LL8461
- LD8461
- LD8471
- LD8481
- LD8491

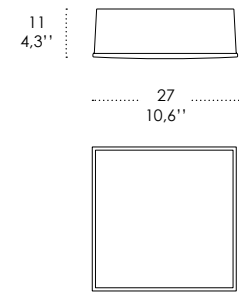

| E27 220-240V | | | | CE |
|--------------|------------------------------|-----------------|-----------|----|
| COD. | FINISHES | LAMP CONNECTION | WATT MAX | |
| LL8461 | NE - RO - AR BL - VE - GI | E27 | 2 x 42 HS | |

| LED 3000K CRI≥90 220-240V | | | | | | | CE |
|---------------------------|------------------------------------|------|---------|---------|---------|------------|----|
| COD. | FINISHES | WATT | TOTAL W | Lm LED | Lm LAMP | BEAM ANGLE | |
| LD8461 | NE3 - RO3 - AR3 BL3 - VE3 - GI3 | 17 W | 18,5 W | 2200 lm | 1510 lm | 120° | |

| LED DIMMER 3000K CRI≥90 220-240V | | | | | | | | CE |
|-----------------------------------|------------------------------------|------|---------|---------|---------|------------|--------|----|
| COD. | FINISHES | WATT | TOTAL W | Lm LED | Lm LAMP | BEAM ANGLE | DIMMER | |
| LD8471 | NE3 - RO3 - AR3 BL3 - VE3 - GI3 | 17 W | 18,5 W | 2200 lm | 1510 lm | 120° | TRIAC | |
| LD8481 | NE3 - RO3 - AR3 BL3 - VE3 - GI3 | 17 W | 18,5 W | 2200 lm | 1510 lm | 120° | DALI | |
| LD8491 | NE3 - RO3 - AR3 BL3 - VE3 - GI3 | 17 W | 18,5 W | 2200 lm | 1510 lm | 120° | WI-FI | |



zafferano

BESPOKE

INDOOR

Collezioni di lampade
per uso interno.

Collection of lamps
for indoor use.

CAMOUFLAGE

DESIGN_Federico de Majo

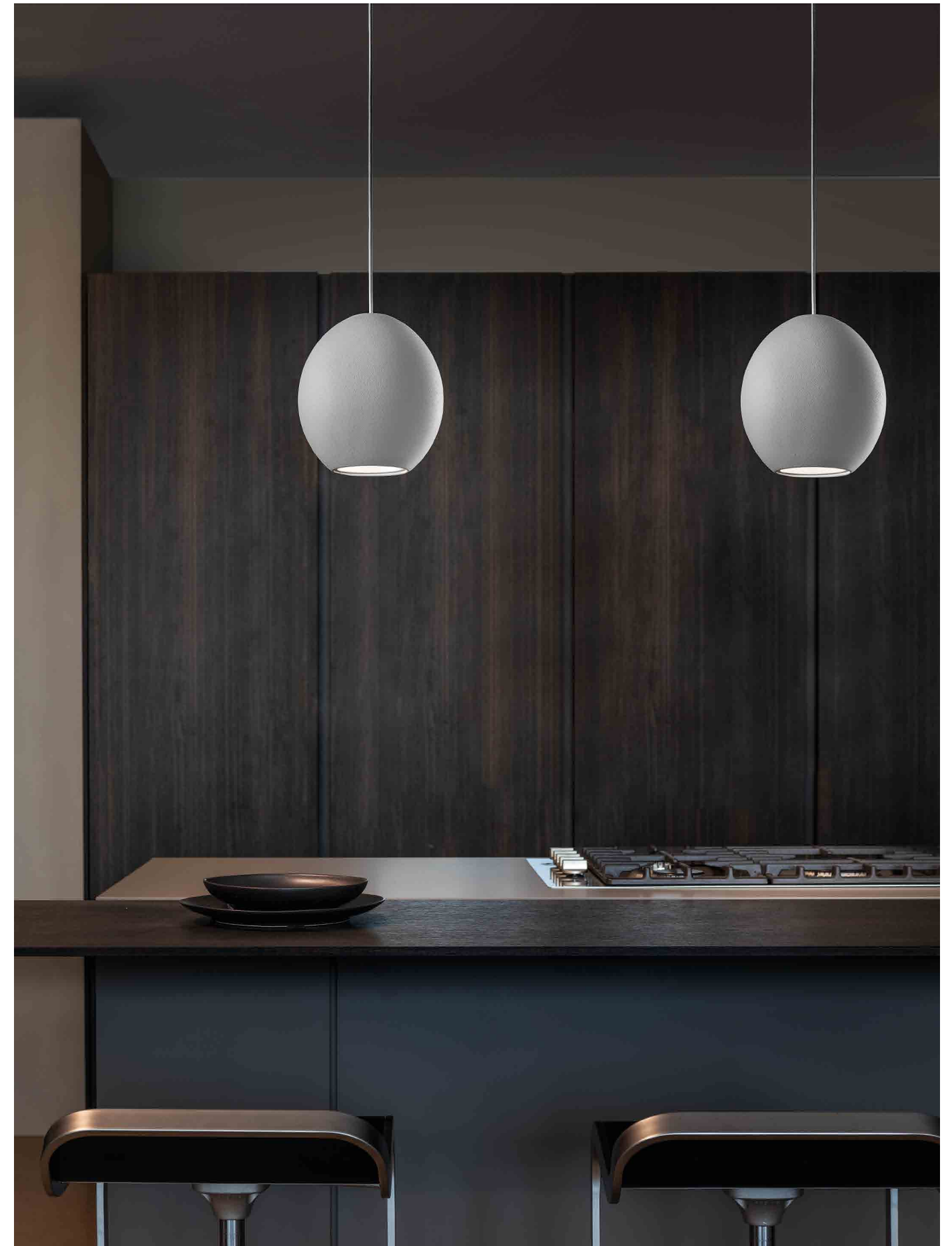





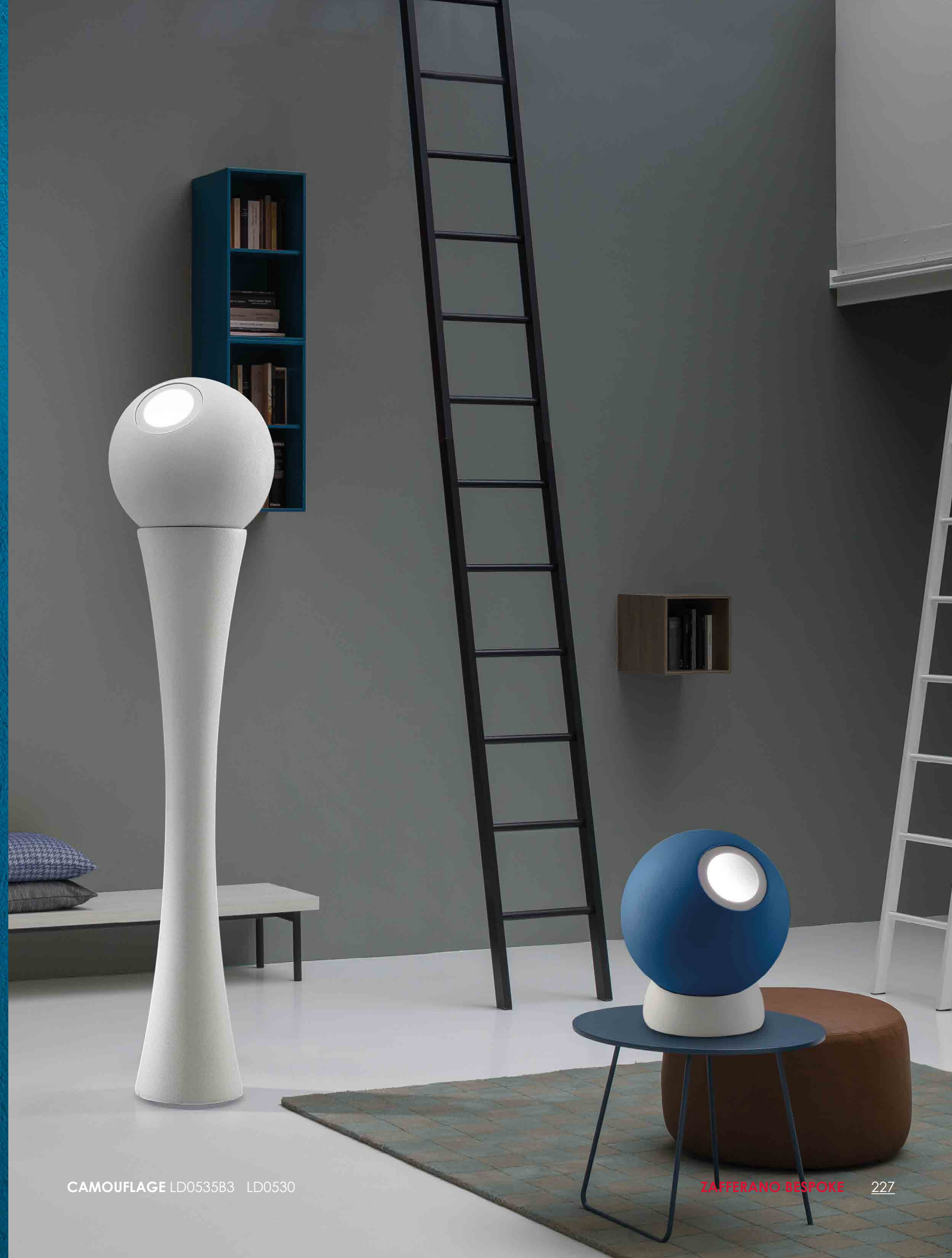
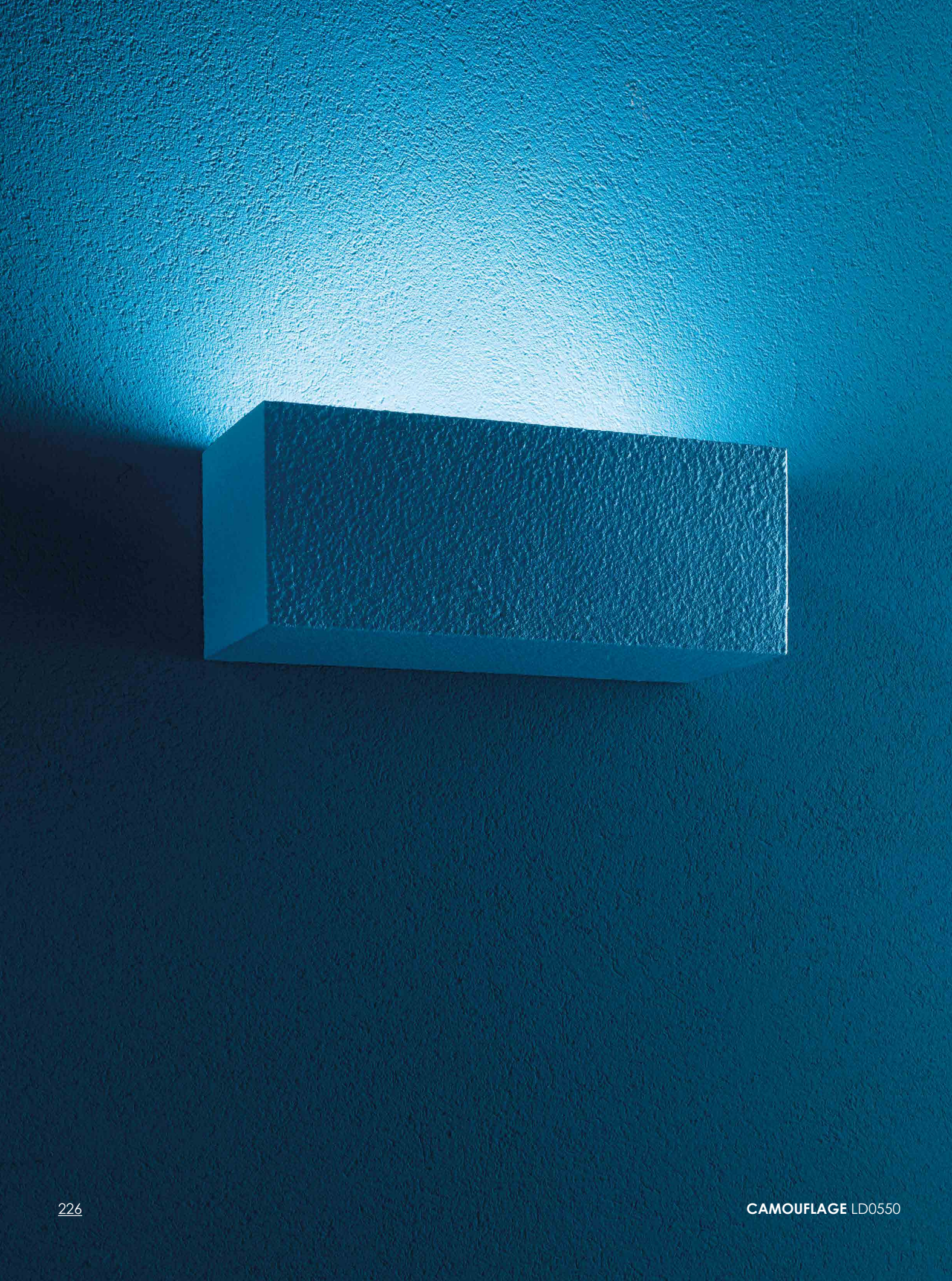

CAMOUFLAGE



B3
Bianco
White

G3
Grigio scuro
Dark grey

S3
Sabbia
Sand

Lampade da parete, soffitto, sospensione, tavolo e terra in materiale ultraleggero autoestinguente con finitura murale nei colori sabbia, bianco o grigio scuro e diffusore in policarbonato trasparente.

Camouflage è personalizzabile e predisposto per essere tinteggiato a piacere in fase di montaggio.

Wall, ceiling, suspension, table and floor lamps made of self-extinguishing ultra-light material with a wall finish in sand, white or dark grey, and a transparent polycarbonate diffuser.

Camouflage can be customised and painted as required during the assembly phase.

Elemento componibile - gruppo luce / Modular element - lamp component kit

LL0501 **LD0501**

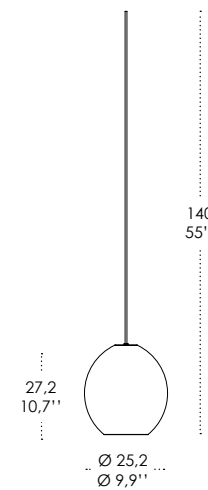

LL0503 **LD0503**

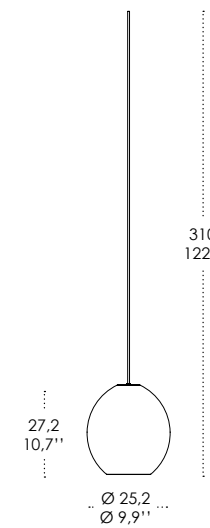

LL0505 **LD0505**

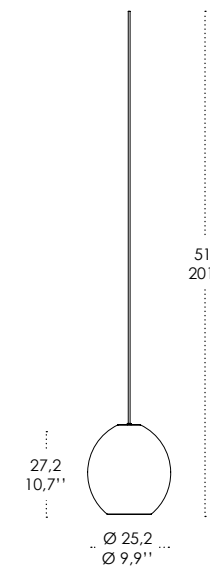

| E27 220-240V CE | | | |
|----------------------------------------------------|--------------|-----------------|----------|
| COD. | FINISHES | LAMP CONNECTION | WATT MAX |
| LL0501 | B3 - G3 - S3 | E27 | 20 W |
| LL0503 | B3 - G3 - S3 | E27 | 20 W |
| LL0505 | B3 - G3 - S3 | E27 | 20 W |

Rosoni compatibili a pag 310 / Compatible canopies at pag 310

| LED 3 STEP 3000K CRI>80 100-240V CE | | | | | |
|------------------------------------------------------------------------|--------------|-------------|---------|--------------|------------|
| COD. | FINISHES | WATT | TOTAL W | Lm LAMP | BEAM ANGLE |
| LD0501 | B3 - G3 - S3 | 6,8 + 6,8 W | 7 + 7 W | 170 + 600 lm | 100° |
| LD0503 | B3 - G3 - S3 | 6,8 + 6,8 W | 7 + 7 W | 170 + 600 lm | 100° |
| LD0505 | B3 - G3 - S3 | 6,8 + 6,8 W | 7 + 7 W | 170 + 600 lm | 100° |

Rosoni compatibili a pag 310 / Compatible canopies at pag 310



LL0500 LED 3 STEP E27
LD0500

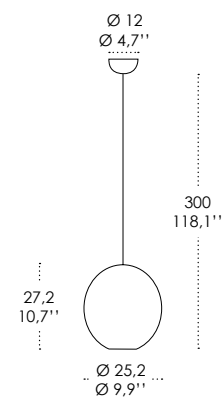

| E27 220-240V IP20 | | | | CE |
|-------------------|--------------|-----------------|----------|----|
| COD. | FINISHES | LAMP CONNECTION | WATT MAX | |
| LL0500 | B3 - G3 - S3 | E27 | 20 W | |

| LED 3 STEP 3000K CRI>80 100-240V IP20 | | | | | | CE |
|---------------------------------------|--------------|-------------|---------|--------------|------------|----|
| COD. | FINISHES | WATT | TOTAL W | Lm LAMP | BEAM ANGLE | |
| LD0500 | B3 - G3 - S3 | 6,8 + 6,8 W | 7 + 7 W | 170 + 600 lm | 100° | |

LD0510 LED DIMMER

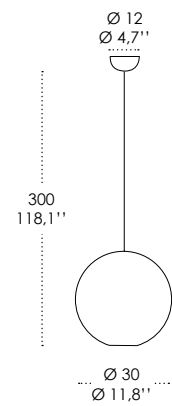

| LED DIMMER 3000K CRI>80 220-240V IP20 | | | | | | CE |
|---------------------------------------|--------------|---------|---------|------------|--------|----|
| COD. | FINISHES | TOTAL W | Lm LAMP | BEAM ANGLE | DIMMER | |
| LD0510 | B3 - G3 - S3 | 12,8 W | 595 lm | 130° | TRIAC | |
| LD0516 | B3 - G3 - S3 | 19,7 W | 990 lm | 140° | TRIAC | |

LD0516 LED DIMMER

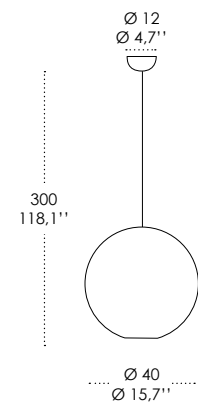

LD0517 LED DIMMER
1+3 luci/1+3 light

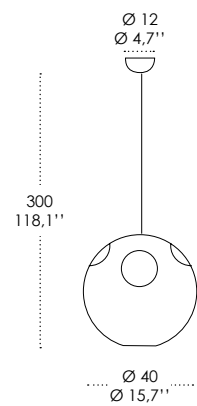

LD0520 LED DIMMER
1+3 luci/1+3 light

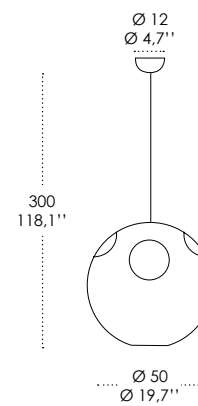

| LED DIMMER 3000K CRI>80 220-240V IP20 | | | | | | CE |
|---------------------------------------|--------------|---------------------|----------------------|------------|--------|----|
| COD. | FINISHES | TOTAL W | Lm LAMP | BEAM ANGLE | DIMMER | |
| LD0517 | B3 - G3 - S3 | 19,7 W + 3 x 12,8 W | 1 x 990 + 3 x 595 lm | 140° | TRIAC | |
| LD0520 | B3 - G3 - S3 | 19,7 W + 3 x 12,8 W | 1 x 990 + 3 x 595 lm | 140° | TRIAC | |

LD0515 LED DIMMER
3 luci/3 lights

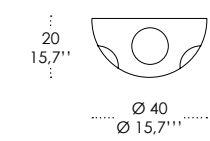

| LED DIMMER 3000K CRI>80 220-240V IP20 | | | | | | CE |
|---------------------------------------|--------------|------------|------------|------------|--------|----|
| COD. | FINISHES | TOTAL W | Lm LAMP | BEAM ANGLE | DIMMER | |
| LD0515 | B3 - G3 - S3 | 3 x 12,8 W | 3 X 595 lm | 130° | TRIAC | |

LD0540 LED 3 STEP
4 luci/4 lights

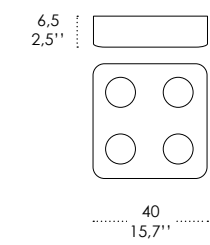

LD0545 LED 3 STEP
4 luci/4 lights

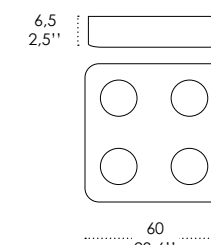

| LED 3 STEP 3000K CRI>80 100-240V IP20 | | | | | | CE |
|---------------------------------------|--------------|-------------------|---------------|-----------------|------------|----|
| COD. | FINISHES | WATT | TOTAL W | Lm LAMP | BEAM ANGLE | |
| LD0540 | B3 - G3 - S3 | 4 x 6,8 + 6,8 W | 4 x 7 + 7 W | 4X170 + 600 lm | 100° | |
| LD0545 | B3 - G3 - S3 | 4 x 13,6 + 13,6 W | 4 x 14 + 14 W | 4X460 + 1050 lm | 100° | |

Parete / Wall

LED 2700K - 4000K su richiesta / on request

LD0550 LED

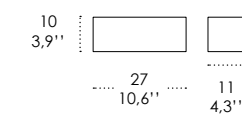

LD0551 LED

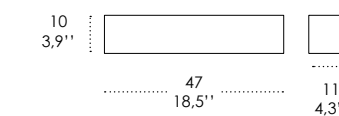

| LED 3000K CRI>80 220-240V IP20 | | | | | CE |
|--------------------------------|--------------|--------|---------|---------|----|
| COD. | FINISHES | WATT | TOTAL W | Lm LED | |
| LD0550 | B3 - G3 - S3 | 8,7 W | 10 W | 1310 lm | |
| LD0551 | B3 - G3 - S3 | 17,5 W | 20 W | 2620 lm | |
| LD0555 | B3 - G3 - S3 | 8,7 W | 10W | 1310 lm | |
| LD0556 | B3 - G3 - S3 | 17,5 W | 20 W | 2620 lm | |

LD0555 LED

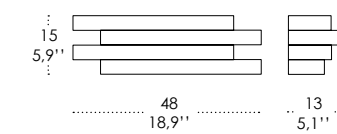

LD0556 LED

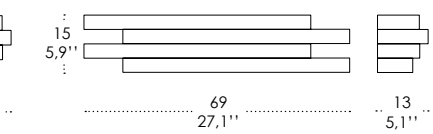

Tavolo / Table

LD0530 LED DIMMER
1 luce / 1 light

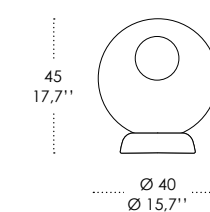

Terra / Floor

LD0535 LED DIMMER
3 luci / 3 lights

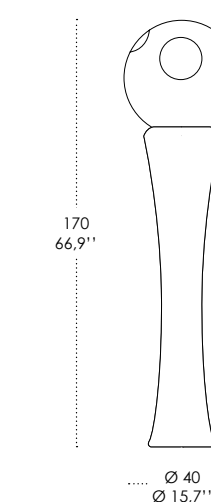

| LED DIMMER 3000K CRI>80 220-240V IP20 | | | | | | CE |
|---------------------------------------|--------------|---------|---------|------------|--------|----|
| COD. | FINISHES | TOTAL W | Lm LAMP | BEAM ANGLE | DIMMER | |
| LD0530 | B3 - G3 - S3 | 19,7 W | 990 lm | 140° | TRIAC | |

| LED DIMMER 3000K CRI>80 220-240V IP20 | | | | | | CE |
|---------------------------------------|--------------|------------|------------|------------|--------|----|
| COD. | FINISHES | TOTAL W | Lm LAMP | BEAM ANGLE | DIMMER | |
| LD0535 | B3 - G3 - S3 | 3 x 12,8 W | 3 x 595 lm | 140° | TRIAC | |

SEVENTIES

DESIGN_Federico de Majo









SEVENTIES

Lampade da parete, da soffitto e a sospensione.
 Diffusore in vetro trasparente, soffiato a bocca con decorazione a rilievo "optical", disponibile in due forme: sfera e cilindro; struttura in metallo con finitura ottone brunito spazzolato e cavi trasparenti.
 Seventies è progettato per essere altamente personalizzabile: è possibile infatti associare, a ciascuna delle sei montature disponibili, le forme di diffusori preferite, anche combinate tra loro.

Wall, ceiling and suspension lamps.
 The clear glass diffuser, mouth blown with a "bubbling" relief decoration that creates a unique optical effect, is available in two shapes: sphere and cylinder; brushed burnished brass finish metal frame and clear plastic cables.
 Seventies is a luminaire designed to be highly customisable: each of the six fixtures available can be matched with any chosen shapes of diffusers, which can also be combined.

Vetro / Glass element

LSL0001 **G9**



LSL0011 **G9**

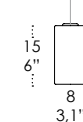

Sospensione / Suspension

LSL3114 + 3 luci / 3 lights **G9**

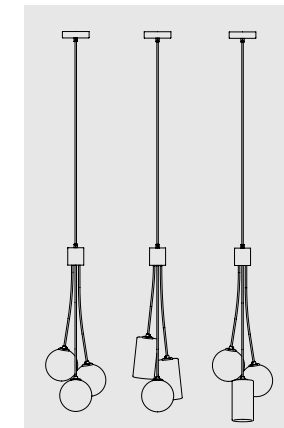
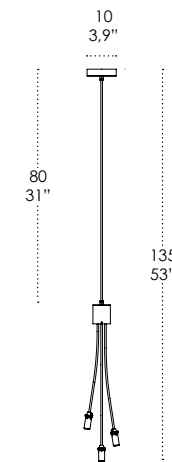

Esempi composizione
 Example of composition

| G9 220-240V IP20 | | | CE |
|------------------|-----------------|-----------|----|
| COD. | LAMP CONNECTION | WATT MAX | |
| LSL3114 | G9 | 3 x 33 HS | |

Vetro e lampadina G9 non inclusi / Glass element and G9 bulb not included

Elemento componibile - gruppo luce / Modular element - lamp component kit

LSL0114 **G9**

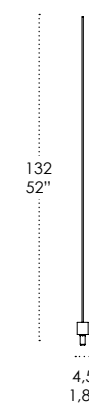

LSL1114 **G9**

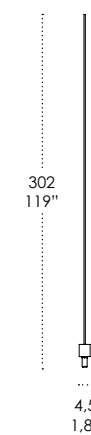

LSL2114 **G9**

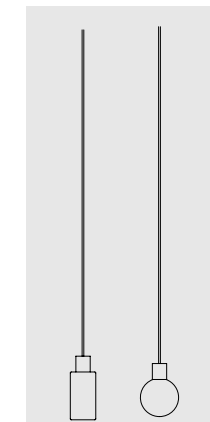
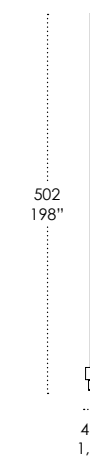

Esempi composizione
 Example of composition

| G9 220-240V IP20 | | | CE |
|------------------|-----------------|----------|----|
| COD. | LAMP CONNECTION | WATT MAX | |
| LSL0114 | G9 | 33 HS | |
| LSL1114 | G9 | 33 HS | |
| LSL2114 | G9 | 33 HS | |

Rosone, vetro e lampadina G9 non inclusi.
 Canopy, glass element and G9 bulb not included.

Rosoni compatibili a pag 310 / Compatible canopies at pag 310



Soffitto / Ceiling

LSL4114 + 5 luci/5 lights **G9**

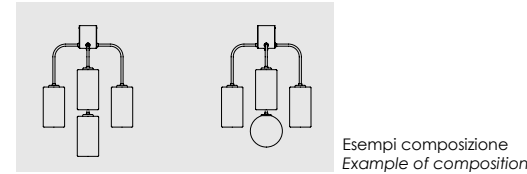
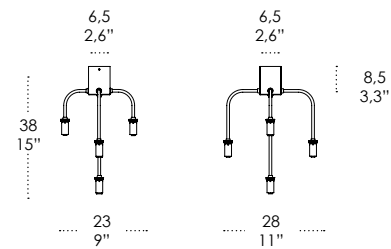

| G9 220-240V IP20 | | | CE |
|------------------|-----------------|-----------|----|
| COD. | LAMP CONNECTION | WATT MAX | |
| LSL4114 | G9 | 5 x 33 HS | |

Vetro e lampadina G9 non inclusi.
Glass element and G9 bulb not included.

Parete / Wall

LSL5114 **G9**

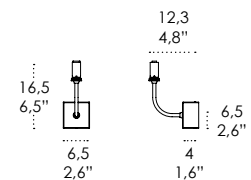

| G9 220-240V IP20 | | | CE |
|------------------|-----------------|----------|----|
| COD. | LAMP CONNECTION | WATT MAX | |
| LSL5114 | G9 | 33 HS | |

Vetro e lampadina G9 non inclusi.
Glass element and G9 bulb not included.



Parete / Wall

LSL6114 + 3 luci / 3 lights **G9**

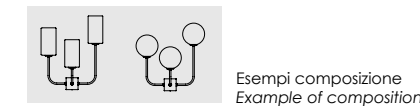
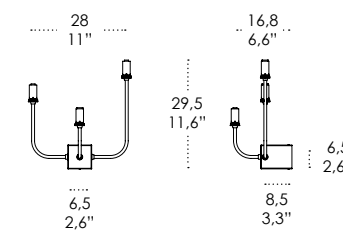

| G9 220-240V IP20 | | | CE |
|------------------|-----------------|-----------|----|
| COD. | LAMP CONNECTION | WATT MAX | |
| LSL6114 | G9 | 3 x 33 HS | |

Vetro e lampadina G9 non inclusi.
Glass element and G9 bulb not included.

Parete / Wall

LSL7114 + 4 luci / 4 lights **G9**

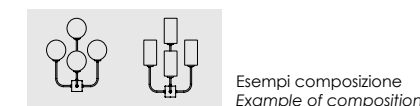
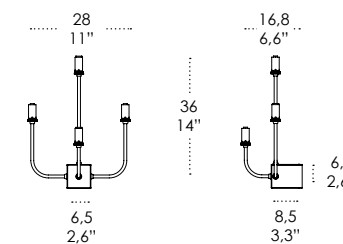

| G9 220-240V IP20 | | | CE |
|------------------|-----------------|-----------|----|
| COD. | LAMP CONNECTION | WATT MAX | |
| LSL7114 | G9 | 4 x 33 HS | |

Vetro e lampadina G9 non inclusi.
Glass element and G9 bulb not included.

Lampadina / Bulb

Compatibile con la maggior parte dei dimmer a taglio di fase in commercio / Compatible with most Triac dimmers available on the market

| LED DIMMER 3000K CRI>80 220-240V 50 Hz | | | | | |
|----------------------------------------|-----------------|-------|--------|-------------------|------------|
| COD. | BULB CONNECTION | WATT | Lm LED | COMPATIBLE DIMMER | BEAM ANGLE |
| LD0180900 | G9 | 4,5 W | 500 lm | Dimmer TRIAC | 360° |

| LED DIMMER 2700K CRI>80 220-240V 50 Hz | | | | | |
|----------------------------------------|-----------------|-------|--------|-------------------|------------|
| COD. | BULB CONNECTION | WATT | Lm LED | COMPATIBLE DIMMER | BEAM ANGLE |
| LD0180901 | G9 | 4,5 W | 480 lm | Dimmer TRIAC | 360° |

MERLINO

DESIGN_Federico de Majo





MERLINO



Lampada a sospensione con diffusore in vetro borosilicato soffiato a bocca e lavorato a mano, in tre varianti di colore. Struttura in metallo verniciato bianco opaco, grigio scuro o corten. Cavi trasparenti. Merlino è un prodotto personalizzabile, per colori e finiture, pensato anche per un uso modulare.

Suspension lamp with diffuser made of handcrafted and mouth-blown borosilicate glass, in three colour options. Matt white, dark grey or corten painted metal frame; clear plastic cables. Merlino is a customizable product, both in colours and finishes, designed also for modular use.

Finitura parti metalliche / Metal parts finishes



Vetro / Glass element

LML00

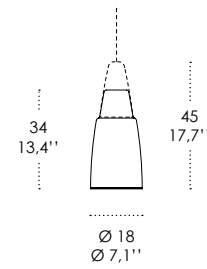

| COD. | FINISHES |
|-------|--------------|
| LML00 | 01 - 04 - 09 |

Montatura / Frame

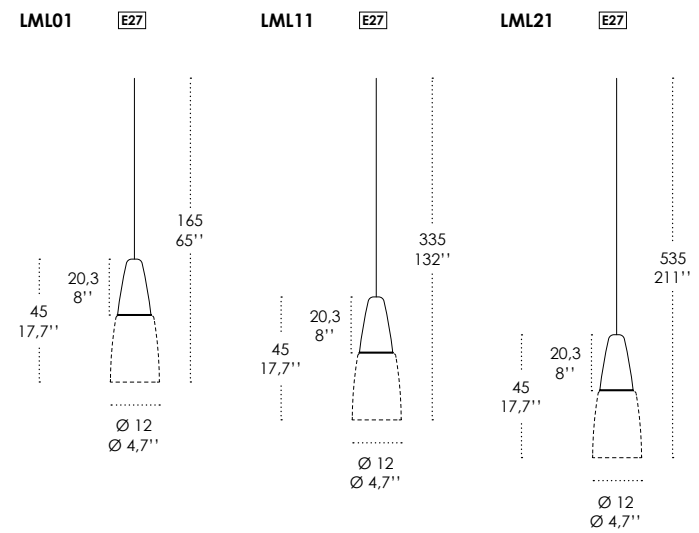

| COD. | FINISHES | LAMP CONNECTION | WATT MAX |
|-------|--------------|-----------------|----------|
| LML01 | 42 - 70 - 73 | E27 | 70 HS |
| LML11 | 42 - 70 - 73 | E27 | 70 HS |
| LML21 | 42 - 70 - 73 | E27 | 70 HS |

Lampadina non inclusa, si consiglia l'uso di una lampadina PAR30 LED (vedere esempio a pag 244).
Bulb not included, we recommend using a PAR30 LED bulb (example at page 244).

Rosoni compatibili a pag 310 / Compatible canopies at pag 310

BALLOON

DESIGN_Federico de Majo



BALLOON



Lampada a sospensione con diffusore in vetro di Murano soffiato a bocca e lavorato a mano con tecniche decorative tipiche muranesi che variano dal "rigadin" al "ritorto", al "balloton" e "balloton sommerso".
Struttura in metallo con finitura ottone brunito spazzolato e cavi in tessuto grigio.
Balloon è un prodotto personalizzabile, per colori e finiture, pensato anche per un uso modulare.

Suspension lamp with diffuser made of mouth-blown Murano glass, handcrafted with traditional decorative techniques, including "rigadin", "ritorto", "balloton" and "balloton sommerso".
Dark grey painted metal frame with chromed details; black fabric cables.
Brushed burnished brass finish metal frame; grey fabric cables.
Balloon is a customizable product, both in colours and finishes, designed also for modular use.

Sospensione / Suspension

Rigadin

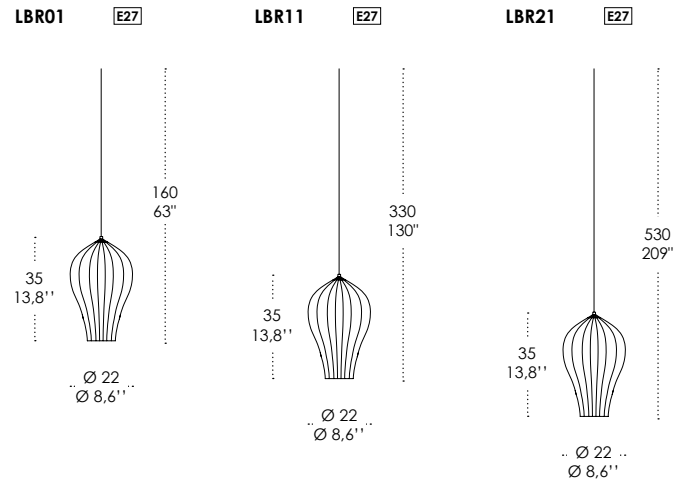

| E27 220-240V IP20 | | | | CE |
|-------------------|-----------------------------|-----------------|----------|----|
| COD. | FINISHES | LAMP CONNECTION | WATT MAX | |
| LBR01 | 04 - 05 - 07 - 09 - 11 - 20 | E27 | 70 HS | |
| LBR11 | 04 - 05 - 07 - 09 - 11 - 20 | E27 | 70 HS | |
| LBR21 | 04 - 05 - 07 - 09 - 11 - 20 | E27 | 70 HS | |

Rosoni compatibili a pag 310 / Compatible canopies at pag 310

Sospensione / Suspension

Rigadin ritorto

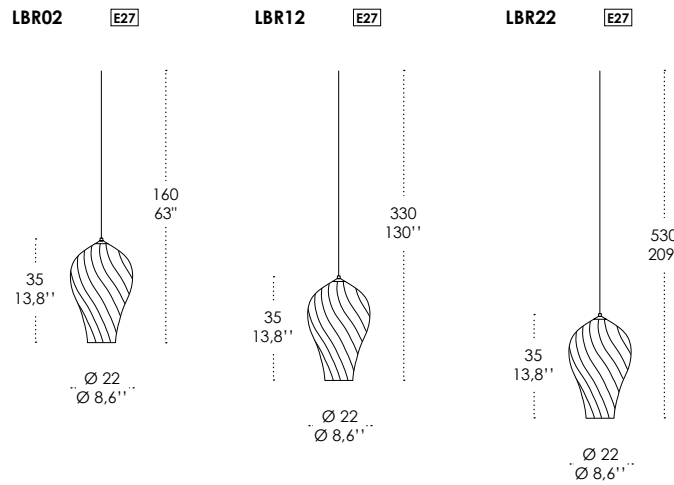

| E27 220-240V IP20 | | | | CE |
|-------------------|-----------------------------|-----------------|----------|----|
| COD. | FINISHES | LAMP CONNECTION | WATT MAX | |
| LBR02 | 04 - 05 - 07 - 09 - 11 - 20 | E27 | 70 HS | |
| LBR12 | 04 - 05 - 07 - 09 - 11 - 20 | E27 | 70 HS | |
| LBR22 | 04 - 05 - 07 - 09 - 11 - 20 | E27 | 70 HS | |

Rosoni compatibili a pag 310 / Compatible canopies at pag 310

Sospensione / Suspension

Balloton

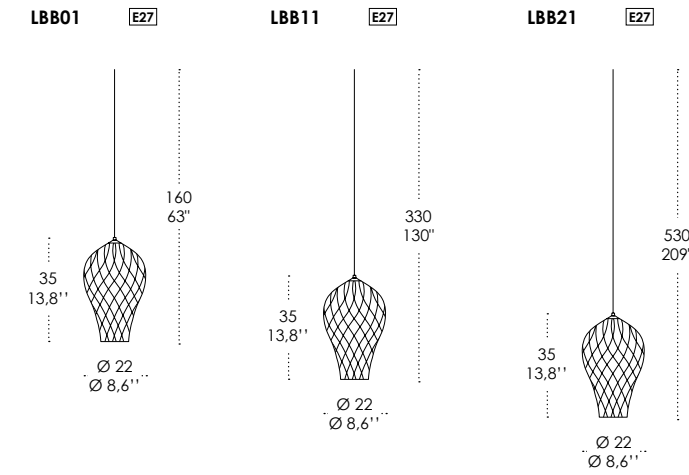

| E27 220-240V IP20 | | | | CE |
|-------------------|-----------------------------|-----------------|----------|----|
| COD. | FINISHES | LAMP CONNECTION | WATT MAX | |
| LBB01 | 04 - 05 - 07 - 09 - 11 - 20 | E27 | 70 HS | |
| LBB11 | 04 - 05 - 07 - 09 - 11 - 20 | E27 | 70 HS | |
| LBB21 | 04 - 05 - 07 - 09 - 11 - 20 | E27 | 70 HS | |

Rosoni compatibili a pag 310 / Compatible canopies at pag 310

Sospensione / Suspension

Balloton sommerso

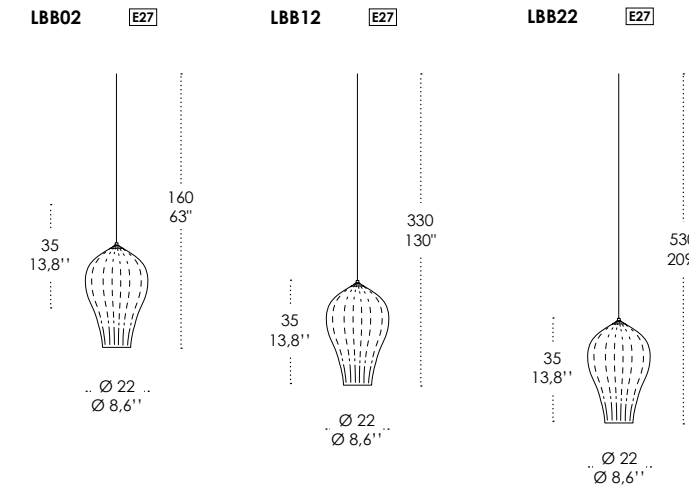

| E27 220-240V IP20 | | | | CE |
|-------------------|-----------------------------|-----------------|----------|----|
| COD. | FINISHES | LAMP CONNECTION | WATT MAX | |
| LBB02 | 04 - 05 - 07 - 09 - 11 - 20 | E27 | 70 HS | |
| LBB12 | 04 - 05 - 07 - 09 - 11 - 20 | E27 | 70 HS | |
| LBB22 | 04 - 05 - 07 - 09 - 11 - 20 | E27 | 70 HS | |

Rosoni compatibili a pag 310 / Compatible canopies at pag 310

LAGUNA

DESIGN_Federico de Majo

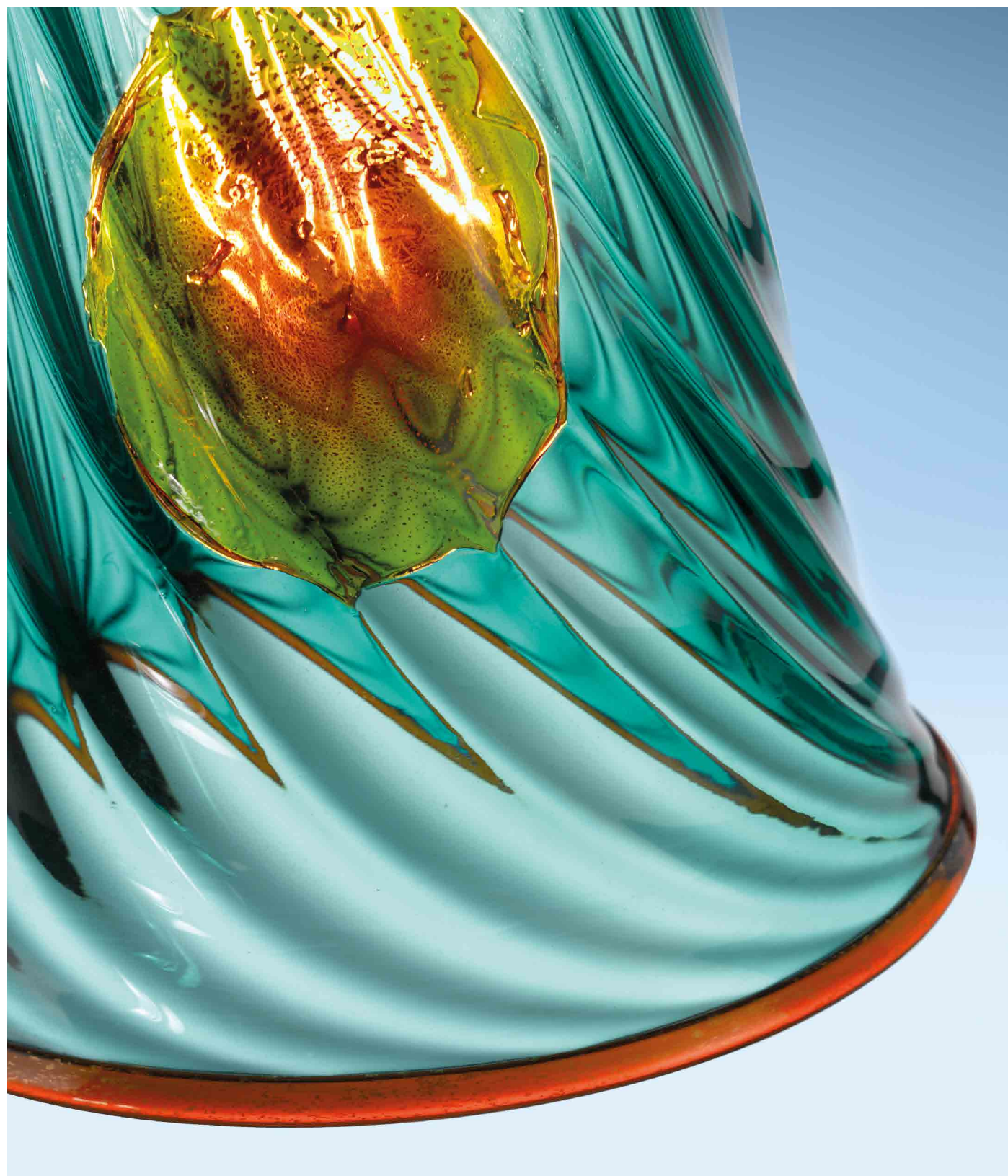



LAGUNA



07
Blu - Bianco
Blue - White



15
Laguna - Ambra
Lagoon - Amber

Lampada a sospensione con diffusore in vetro di Murano soffiato a bocca e lavorato a mano con tecniche decorative tipiche muranesi. Struttura in metallo con finitura ottone brunito spazzolato e cavi in tessuto grigio. Laguna è un prodotto personalizzabile, per colori e finiture, pensato anche per un uso modulare.

Suspension lamp with diffuser made of mouth-blown Murano glass, handcrafted with traditional decorative techniques. Brushed burnished brass finish metal frame; grey fabric cables. Laguna is a customizable product, both in colours and finishes, designed also for modular use.

Sospensione / Suspension

LLG01

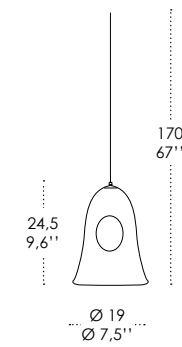

LLG11

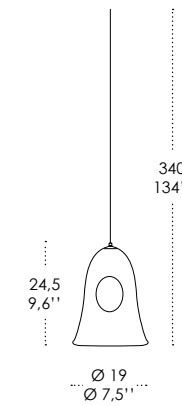

LLG21

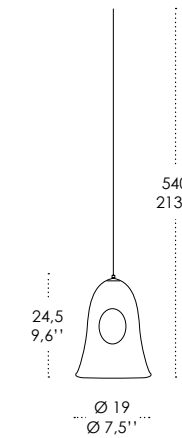

| E27 220-240V | | | | CE |
|--------------|----------|-----------------|----------|----|
| COD. | FINISHES | LAMP CONNECTION | WATT MAX | |
| LLG01 | 07 - 15 | E27 | 70 HS | |
| LLG11 | 07 - 15 | E27 | 70 HS | |
| LLG21 | 07 - 15 | E27 | 70 HS | |

Rosoni compatibili a pag 310 / Compatible canopies at pag 310

LUCE LIQUIDA

DESIGN_Ann Barbara e Federico de Majo





LUCE LIQUIDA



03
Acquamare
Righe blu

Acquamarine
Blue stripes



09
Fumé
Righe blu

Grey
Blue stripes



11
Rosso
Righe nere

Red
Black stripes

Oggetto luminoso con diffusore in vetro di Murano soffiato a bocca, lavorato a mano con tecniche decorative tipiche muranesi. Struttura in metallo cromato e cavi in tessuto blu o rosso. Luce Liquida è una collezione di vasi "contenitori di luce": creazioni luminose che danno forma alle trasparenze del vetro lavorato in fornace dagli abili gesti dei maestri vetrai. Prodotto personalizzabile.

Luminous object, with diffuser made of mouth-blown Murano glass, handcrafted with traditional decorative techniques. Chromed metal frame, blue or red fabric cables. Luce Liquida is a collection of vases that become "containers for light", luminous creations that give shape to the glass transparencies, crafted in a furnace by the hands of skilled master glassblowers. Customizable product.

Vetro / Glass element

LLQ00

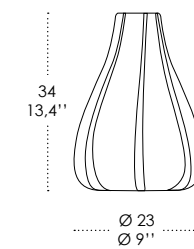

| COD. | FINISHES |
|-------|----------|
| LLQ00 | 03 |
| LLQ00 | 09 |
| LLQ00 | 11 |



Cavo in tessuto / Fabric cable

LLQ0107

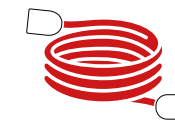

LLQ0111



| E27 220-240V IP20    CE | | | |
|---------------------------------------------------------------------------------------------------------------------------------------------------------------------------------------------------------------------------------------------------------------------------------------------------------------------------|------------------------|-----------------|----------|
| COD. | FINISHES | LAMP CONNECTION | WATT MAX |
| LLQ0107 | Cavo blu / Blue cable | E27 | 70 HS |
| LLQ0111 | Cavo rosso / Red cable | E27 | 70 HS |

Lampadina non inclusa / Bulb not included



selezionato da / selected by
ADI DESIGN INDEX 2019

ROMEO E GIULIETTA



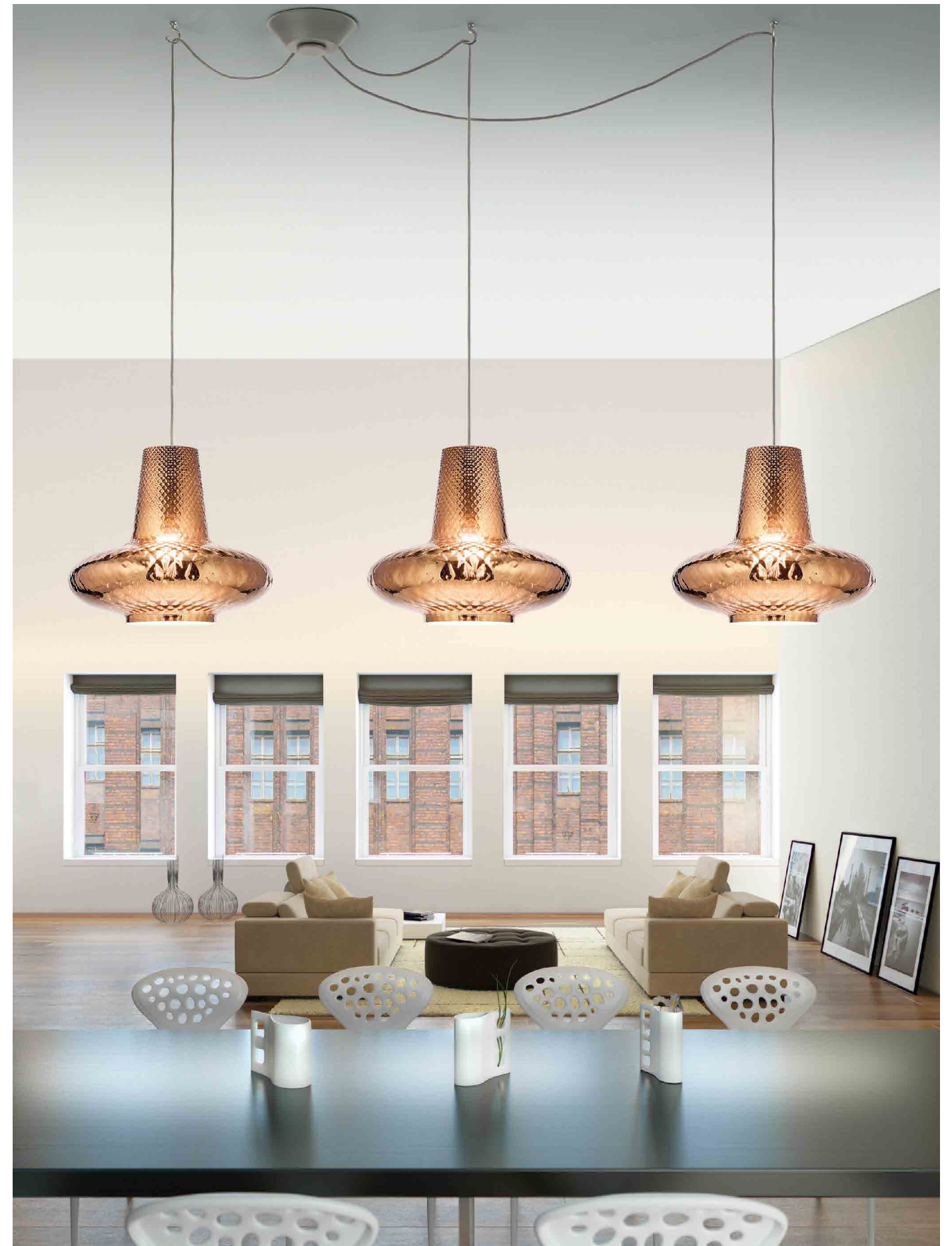





DESIGN_Federico de Majo







ROMEO E GIULIETTA

| | | |
|-----------------------------------------------------------------------------------------------------------------------------------|--------------------------------------------------------------------------------------------------------------------------|---------------------------------------------------------------------------------------------------------------------------|
|  01 Trasparente Clear |  04 Ambra Amber |  05 Ametista Amethyst |
|  09 Fumé Grey |  20 Bluino Light blue |  21 Argento Silver |
|  22 Oro antico Antique gold |  23 Bronzo Bronze |  24 Oro rosa Pink gold |

Lampade a sospensione con diffusore in vetro soffiato a bocca e lavorato a mano con finitura a rilievo "balloton" in due forme e in diversi colori. Struttura in metallo verniciato grigio e cavi in tessuto grigio.
Romeo e Giulietta è un prodotto personalizzabile, per colori e finiture, pensato anche per un uso modulare.



Suspension lamps with diffuser made of mouth-blown glass, handcrafted with "balloton" relief finish, in two shapes and in various colours. Grey painted metal frame, grey fabric cables. Romeo e Giulietta is a customizable product, both in colours and finishes, designed also for modular use.

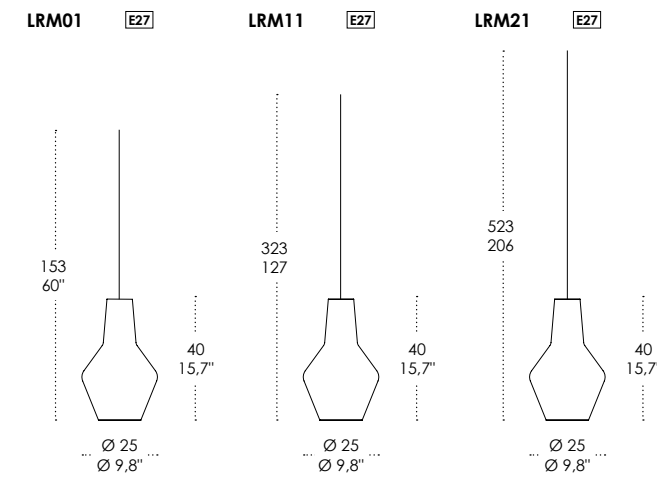

Esempio acceso - spento. Versioni vetro metallizzato.
Example on - off. Metallic glass version.

ROMEO Elemento modulare - gruppo luce / Modular element - lamp component kit





| E27 220-240V   | | | |
|--------------------------------------------------------------------------------------------------------------------------------------------------------------------------------------|-----------------------------------------------------|-----------------|----------|
| COD. | FINISHES | LAMP CONNECTION | WATT MAX |
| LRM01 | 01 - 04 - 05 - 09 - 20 21 - 22 - 23 - 24 | E27 | 70 HS |
| LRM11 | 01 - 04 - 05 - 09 - 20 21 - 22 - 23 - 24 | E27 | 70 HS |
| LRM21 | 01 - 04 - 05 - 09 - 20 21 - 22 - 23 - 24 | E27 | 70 HS |

Rosoni compatibili a pag 310 / Compatible canopies at pag 310

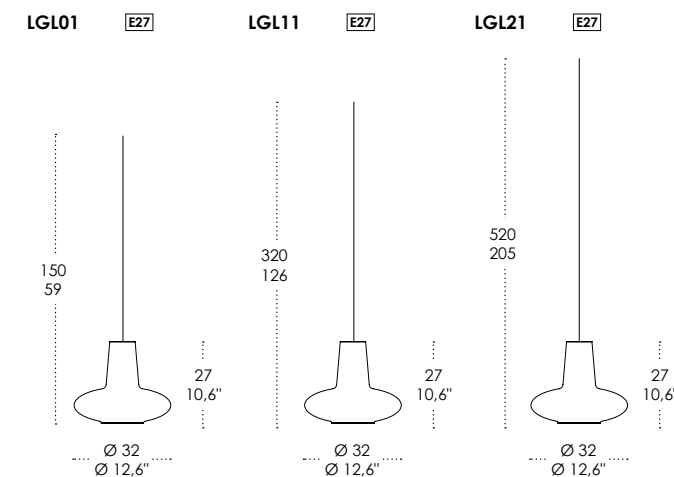
GIULIETTA Elemento modulare - gruppo luce / Modular element - lamp component kit



| E27 220-240V   | | | |
|------------------------------------------------------------------------------------------------------------------------------------------------------------------------------------------|-----------------------------------------------------|-----------------|----------|
| COD. | FINISHES | LAMP CONNECTION | WATT MAX |
| LGL01 | 01 - 04 - 05 - 09 - 20 21 - 22 - 23 - 24 | E27 | 70 HS |
| LGL11 | 01 - 04 - 05 - 09 - 20 21 - 22 - 23 - 24 | E27 | 70 HS |
| LGL21 | 01 - 04 - 05 - 09 - 20 21 - 22 - 23 - 24 | E27 | 70 HS |

Rosoni compatibili a pag 310 / Compatible canopies at pag 310

BONNIE E CLYDE

DESIGN_Federico de Majo

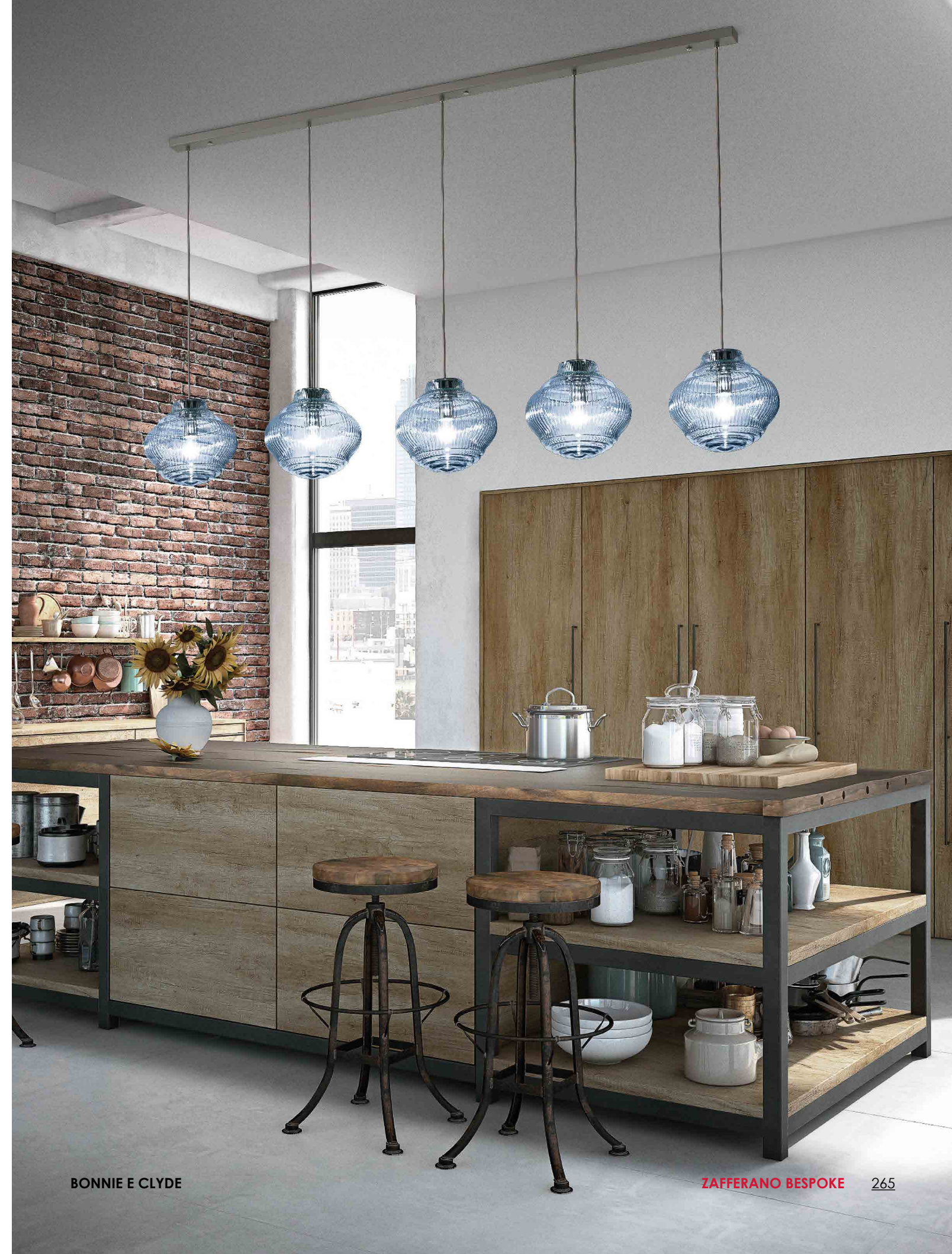





BONNIE E CLYDE

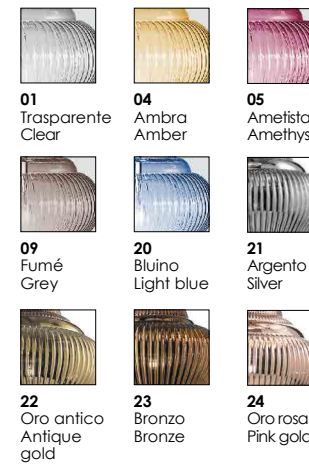

Lampade a sospensione con diffusore in vetro soffiato a bocca e lavorato a mano su stampo a fermo con finitura a rilievo "rigadin", in due forme e in diversi colori. Struttura in metallo verniciato grigio e cavi in tessuto grigio. Bonnie e Clyde è un prodotto personalizzabile, per colori e finiture, pensato anche per un uso modulare.

Suspension lamps with glass diffuser, mouth-blown in standstill mould, with "rigadin" relief finish, in two shapes and in various colours. Grey painted metal frame, grey fabric cables. Bonnie e Clyde is a customizable product, both in colours and finishes, designed also for modular use.



Esempio acceso - spento. Versioni vetro metallizzato.
Example on - off. Metallic glass version.

BONNIE Elemento modulare - gruppo luce / Modular element - lamp component kit

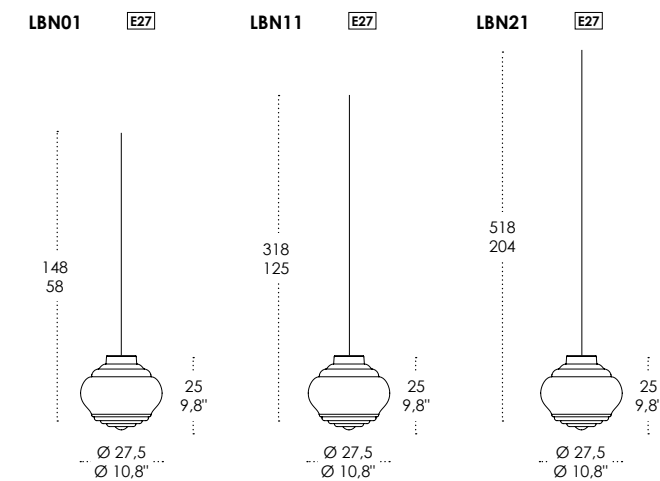

| E27 220-240V IP20 | | | | CE |
|-------------------|---------------------------------------------|-----------------|----------|----|
| COD. | FINISHES | LAMP CONNECTION | WATT MAX | |
| LBN01 | 01 - 04 - 05 - 09 - 20 21 - 22 - 23 - 24 | E27 | 70 HS | |
| LBN11 | 01 - 04 - 05 - 09 - 20 21 - 22 - 23 - 24 | E27 | 70 HS | |
| LBN21 | 01 - 04 - 05 - 09 - 20 21 - 22 - 23 - 24 | E27 | 70 HS | |

Rosoni compatibili a pag 310 / Compatible canopies at pag 310

CLYDE Elemento modulare - gruppo luce / Modular element - lamp component kit

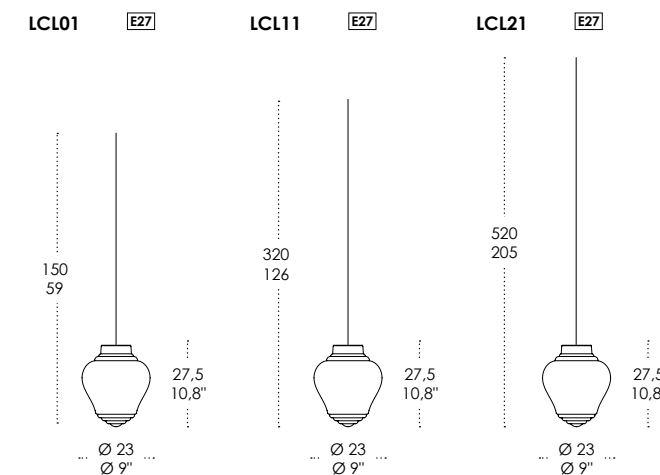

| E27 220-240V IP20 | | | | CE |
|-------------------|---------------------------------------------|-----------------|----------|----|
| COD. | FINISHES | LAMP CONNECTION | WATT MAX | |
| LCL01 | 01 - 04 - 05 - 09 - 20 21 - 22 - 23 - 24 | E27 | 70 HS | |
| LCL11 | 01 - 04 - 05 - 09 - 20 21 - 22 - 23 - 24 | E27 | 70 HS | |
| LCL21 | 01 - 04 - 05 - 09 - 20 21 - 22 - 23 - 24 | E27 | 70 HS | |

Rosoni compatibili a pag 310 / Compatible canopies at pag 310

ONDA

DESIGN_Federico de Majo

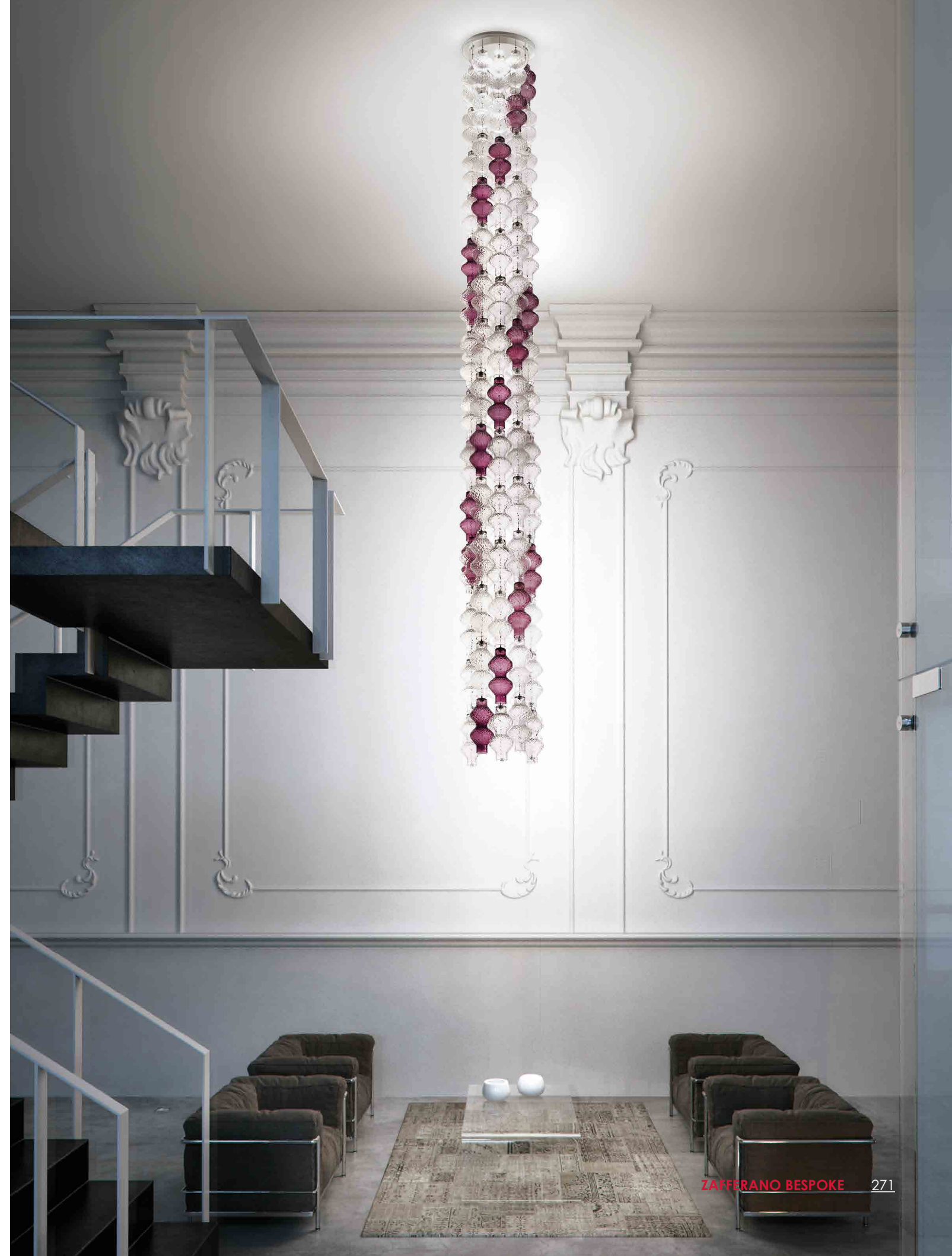



ONDA

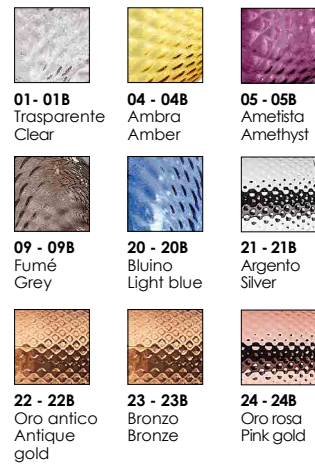

Lampade da parete, a sospensione e da tavolo con diffusore in vetro soffiato a bocca e lavorato a mano con finitura a rilievo "balloton" in diversi colori.
Struttura in metallo verniciato grigio opaco e particolari cromati; paralume in tessuto bianco. Onda è un prodotto personalizzabile, per colori e finiture, pensato anche per un uso modulare.

Wall, suspension and table lamps with diffuser made of mouth-blown glass, handcrafted with "balloton" relief finish, in various colours. Matt grey painted metal frame, with chromed metal details; grey fabric cables, white fabric lampshade. Onda is a customizable product, both in colours and finishes, designed also for modular use.

Vetro / Glass element

LON05

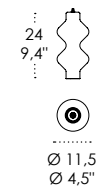

| COD. | FINISHES |
|-------|--------------------------------------------|
| LON05 | 01 - 04 - 05 - 09 - 20 - 21 - 22 - 23 - 24 |

Base universale per sospensione / Standard frame for hanging lamp

Dimmerabile su richiesta / Dimmable on request

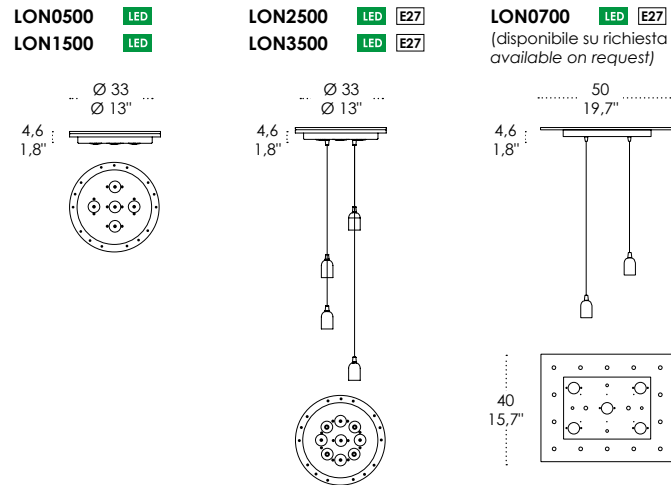

Esempi di composizione / Example of composition.

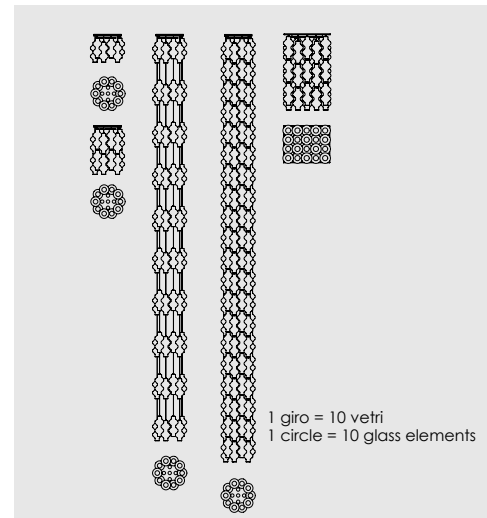

| LED 3000K CRI>80 220-240V IP20 | | | | | | CE |
|--------------------------------|--------------|---------|---------|------------|------------|----|
| COD. | FINISHES | W LED | TOTAL W | Lm LED | BEAM ANGLE | |
| LON0500 | grigio/grey | 5 x 4 W | 5 x 4 W | 5 x 420 lm | 120° | |
| LON1500 | bianco/white | 5 x 4 W | 5 x 4 W | 5 x 420 lm | 120° | |

Inclusi 10 cavi acciaio 5 metri. / Including 10 steel cables 196.8 in.

| LED + E27 3000K CRI>80 220-240V IP20 | | | | | | CE |
|--------------------------------------|--------------|---------|--------------------------------|------------|------------|----|
| COD. | FINISHES | W LED | TOTAL W | Lm LED | BEAM ANGLE | |
| LON2500 | grigio/grey | 5 x 4 W | LED 5 x 4 W E27 4 x 70 W HS | 5 x 420 lm | 120° | |
| LON3500 | bianco/white | 5 x 4 W | LED 5 x 4 W E27 4 x 70 W HS | 5 x 420 lm | 120° | |

Inclusi 10 cavi acciaio 5 metri - regolabile (4 cavi da 5 metri).
Including 10 steel cables 196.8 in - adjustable (4 cables to 196.8 in).

| LED + E27 3000K CRI>80 220-240V IP20 | | | | | | CE |
|--------------------------------------|--------------|---------|--------------------------------|------------|------------|----|
| COD. | FINISHES | W LED | TOTAL W | Lm LED | BEAM ANGLE | |
| LON0700 | cromo/chrome | 5 x 4 W | LED 5 x 4 W E27 2 x 70 W HS | 5 x 420 lm | 120° | |

Inclusi 20 cavi acciaio 1,2 metri - regolabile (2 cavi da 0,7 metri).
Including 20 steel cables 47.2 in - adjustable (2 cables to 27.5 in).

Base universale per applique / Standard metal frame for applique

LON0600 LED

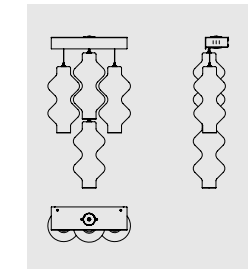
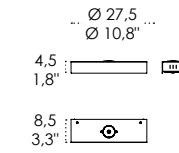

Esempio di installazione 4 vetri
Example of installation with 4 glasses

| LED 3000K CRI>80 220-240V IP20 | | | | | | CE |
|--------------------------------|-------------|---------|---------|------------|------------|----|
| COD. | FINISHES | W LED | TOTAL W | Lm LED | BEAM ANGLE | |
| LON0600 | grigio/grey | 3 x 4 W | 3 x 4 W | 3 x 420 lm | 120° | |

Inclusi 3 cavi acciaio 1,25 metri. / Including 3 steel cables (49.2 in each).

Dimmerabile su richiesta / Dimmable on request

Tavolo / Table

LON01 E27

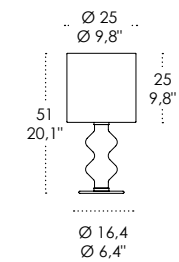

| E27 220-240V IP20 | | | CE |
|-------------------|------------------------------------------------------|----------|----|
| COD. | FINISHES | WATT MAX | |
| LON01 | 01B - 04B - 05B - 09B - 20B 21B - 22B - 23B - 24B | 70 W HS | |

Paralume bianco / White lampshade

SHOW

DESIGN_Federico de Majo



SHOW

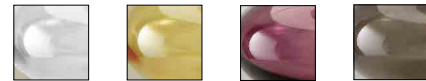

01B Trasparente Clear
04B Ambra Amber
05B Ametista Amethyst
09B Fumé Grey

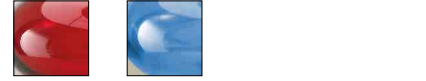

11B Rosso Red
20B Bluino Light blue

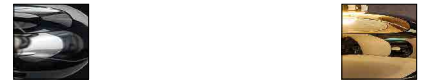

21N Vetro argento, montatura cromo e paralume nero + PVC cromo / Silver glass, chrome fitting and black + chrome PVC lampshade
22N Vetro oro antico, montatura oro lucido e paralume nero + PVC oro / Antique gold glass, polished gold and black + gold PVC lampshade

Lampade da parete, da terra e da tavolo con struttura in metallo cromato e vetro soffiato a bocca e lavorato a mano in due forme e diversi colori. Paralume in tessuto nero + PVC cromo, tessuto nero + PVC oro o in tessuto bianco. Prodotto personalizzabile.

Wall, floor and table lamps with chromed metal frame and mouth-blown, handcrafted glass elements, available in two shapes and various colours. Black fabric lampshade + chromed effect PVC; black fabric lampshade + gold effect PVC; or white fabric lampshade. Customizable product.

Terra / Floor

LSH12 E27
OGIVA / OGIVE

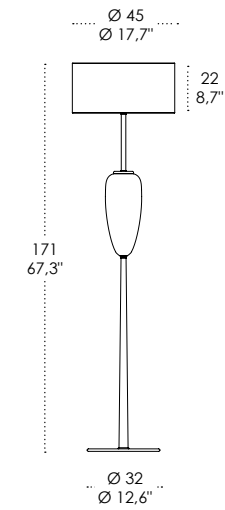

LSH13 E27
ELLISSE / ELLIPSE

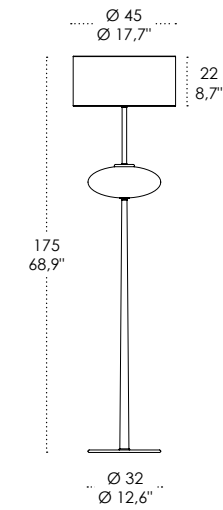

| E27 220-240V IP20 | | | CE |
|-------------------|------------------------------------------------|----------|----|
| COD. | FINISHES | WATT MAX | |
| LSH12 | 01B - 04B - 05B - 09B - 11B 20B - 21N - 22N | 105 HS | |
| LSH13 | 01B - 04B - 05B - 09B - 11B 20B - 21N - 22N | 105 HS | |

Parete / Wall

LSH22 E27
OGIVA / OGIVE

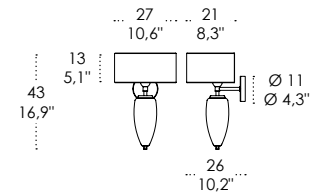

LSH23 E27
ELLISSE / ELLIPSE

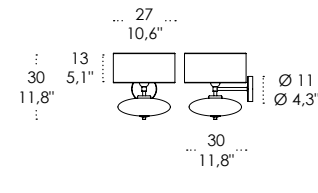

| E27 220-240V IP20 | | | CE |
|-------------------|------------------------------------------------|----------|----|
| COD. | FINISHES | WATT MAX | |
| LSH22 | 01B - 04B - 05B - 09B - 11B 20B - 21N - 22N | 70 HS | |
| LSH23 | 01B - 04B - 05B - 09B - 11B 20B - 21N - 22N | 70 HS | |

Tavolo / Table

LSH02 E27
OGIVA / OGIVE

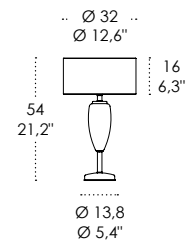

LSH03 E27
ELLISSE / ELLIPSE

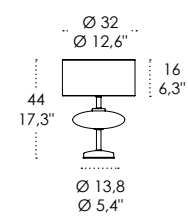

| E27 220-240V IP20 | | | CE |
|-------------------|------------------------------------------------|----------|----|
| COD. | FINISHES | WATT MAX | |
| LSH02 | 01B - 04B - 05B - 09B - 11B 20B - 21N - 22N | 70 HS | |
| LSH03 | 01B - 04B - 05B - 09B - 11B 20B - 21N - 22N | 70 HS | |
| LSH06 | 01B - 04B - 05B - 09B - 11B 20B - 21N - 22N | 105 HS | |
| LSH07 | 01B - 04B - 05B - 09B - 11B 20B - 21N - 22N | 105 HS | |

LSH06 E27
OGIVA / OGIVE

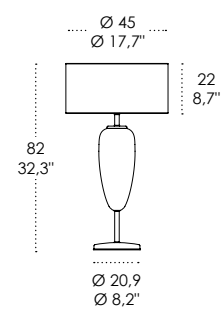

LSH07 E27
ELLISSE / ELLIPSE

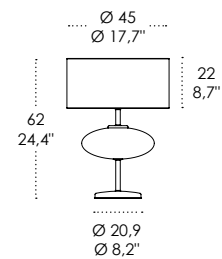

REGOLO

DESIGN_Federico de Majo



- 01** Trasparente
Clear
- 02** Trasparente
Nero
Clear
Black
- 04** Trasparente
Ambra
Clear
Amber



- 05** Trasparente
Ametista
Clear
Amethyst
- 11** Trasparente
Rosso
Clear
Red
- 21** Trasparente
Argento
Clear
Silver



- 22** Trasparente
Oro antico
Clear
Antique gold
- 23** Trasparente
Bronzo
Clear
Bronze
- 24** Trasparente
Oro rosa
Clear
Pink gold

Lampade da soffitto con vetro diffusore in piastra lavorato a mano e sfere in vetro soffiato a bocca con finitura a rilievo "balloton" in diversi colori. Struttura in metallo verniciato bianco opaco e dettagli cromati. Prodotto personalizzabile.

Ceiling lamps with handcrafted plate glass diffuser and mouth-blown glass spheres, with "balloton" relief finish, in various colours. Matt white painted metal frame with chromed details. Customizable product.

Soffitto / Ceiling

LRG05
LRG15

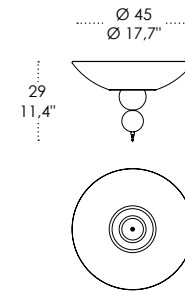

LRG06
LRG16

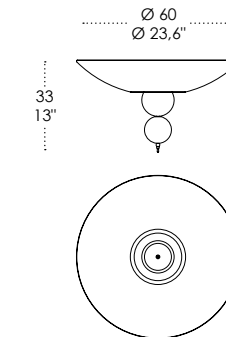

| E27 220-240V | | | | CE |
|--------------|---------------------------------------------|-----------------|----------|----|
| COD. | FINISHES | LAMP CONNECTION | WATT MAX | |
| LRG15 | 01 - 02 - 04 - 05 - 11 21 - 22 - 23 - 24 | E27 | 3 x 70 W | |
| LRG16 | 01 - 02 - 04 - 05 - 11 21 - 22 - 23 - 24 | E27 | 4 x 70 W | |

| LED 2900K CRI>80 220-240V | | | | | | CE |
|---------------------------|---------------------------------------------|--------|---------|---------|------------|----|
| COD. | FINISHES | W LED | TOTAL W | Lm LED | BEAM ANGLE | |
| LRG05 | 01 - 02 - 04 - 05 - 11 21 - 22 - 23 - 24 | 27,5 W | 29 W | 3000 lm | 120° | |
| LRG06 | 01 - 02 - 04 - 05 - 11 21 - 22 - 23 - 24 | 59,5 W | 64 W | 6400 lm | 120° | |

PERLE

DESIGN_Federico de Majo

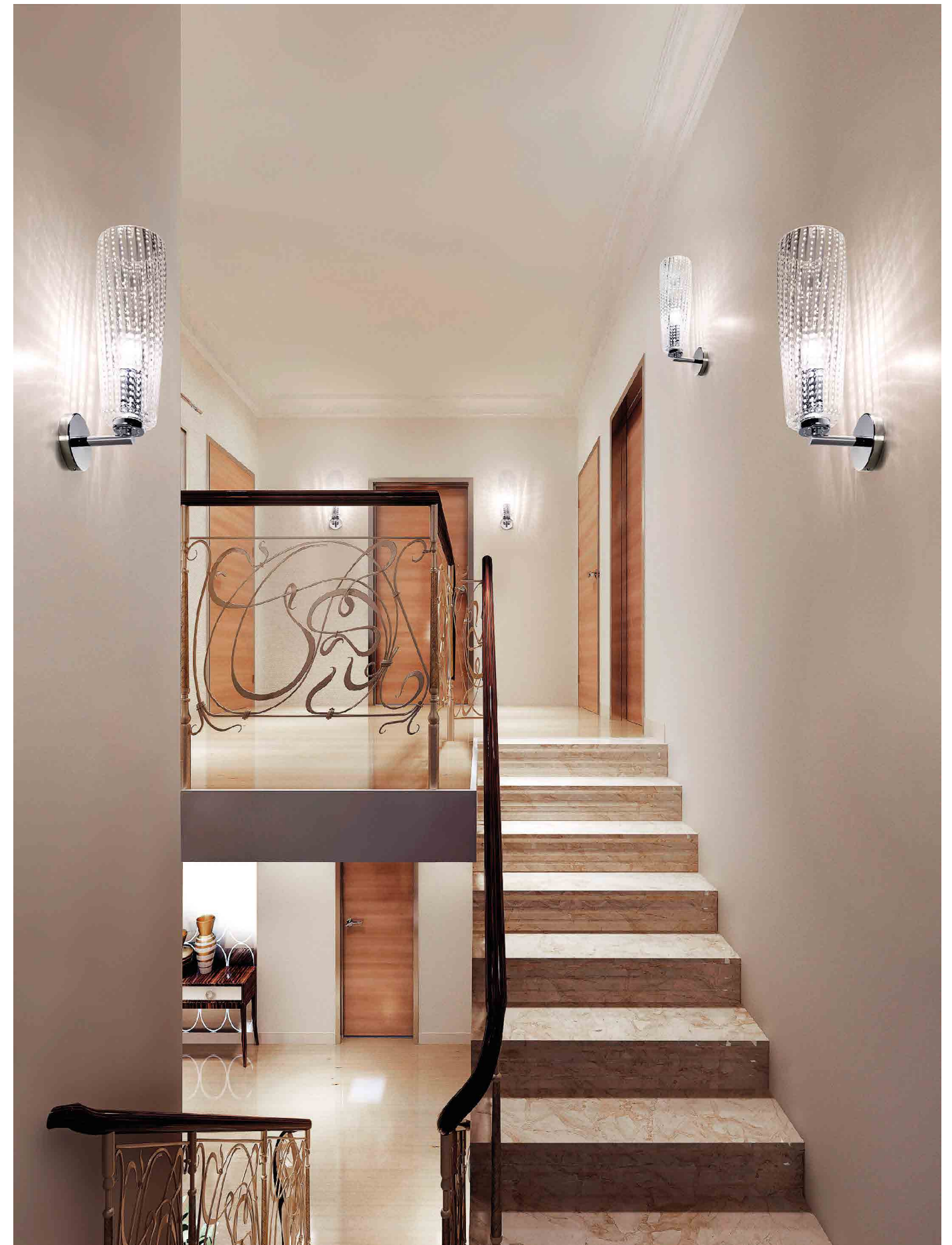



PERLE



Lampade da parete, a sospensione, da terra e da tavolo con struttura in metallo cromato e vetro soffiato a bocca e lavorato a mano in diversi colori. Paralume in tessuto bianco. La sospensione, personalizzabile in colori e finiture, è pensata anche per un uso modulare.

Wall, suspension, floor and table lamps with chromed metal frame and mouth-blown, handcrafted glass elements, available in various colours. White fabric lampshade. Customizable product, both in colours and finishes. The suspension version is designed also for modular use.

Elemento componibile - gruppo luce / Modular element - lamp component kit

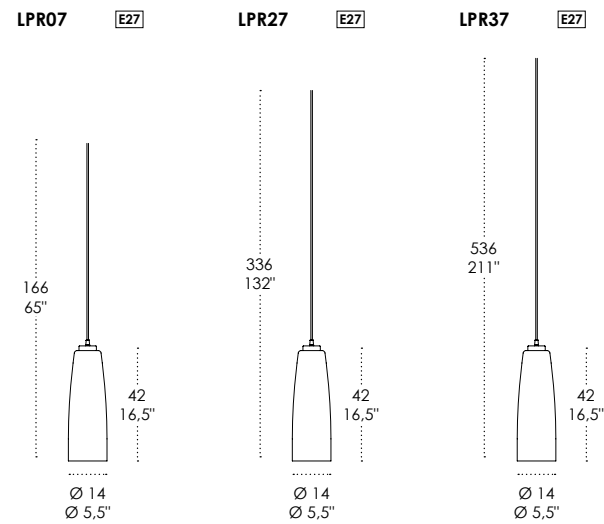
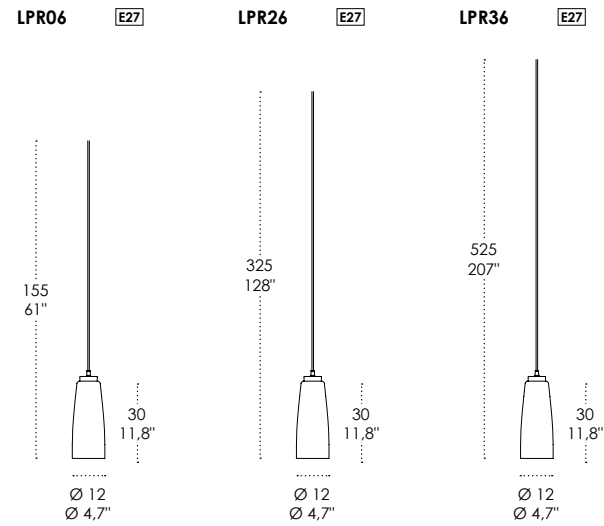

| E27 220-240V IP20 | | | |
|-------------------|------------------------------|-----------------|----------|
| COD. | FINISHES | LAMP CONNECTION | WATT MAX |
| LPR06 | 01 - 06 - 07 09 - 11 - 13 | E27 | 70 HS |
| LPR26 | 01 - 06 - 07 09 - 11 - 13 | E27 | 70 HS |
| LPR36 | 01 - 06 - 07 09 - 11 - 13 | E27 | 70 HS |
| LPR07 | 01 - 06 - 07 09 - 11 - 13 | E27 | 70 HS |
| LPR27 | 01 - 06 - 07 09 - 11 - 13 | E27 | 70 HS |
| LPR37 | 01 - 06 - 07 09 - 11 - 13 | E27 | 70 HS |

Rosoni compatibili a pag 310 / Compatible canopies at pag 310

Parete / Wall

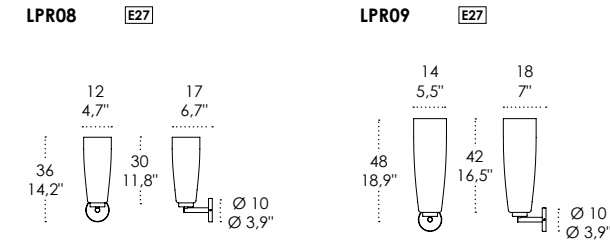

| E27 220-240V IP20 | | | |
|-------------------|------------------------------|-----------------|----------|
| COD. | FINISHES | LAMP CONNECTION | WATT MAX |
| LPR08 | 01 - 06 - 07 09 - 11 - 13 | E27 | 105 HS |
| LPR09 | 01 - 06 - 07 09 - 11 - 13 | E27 | 105 HS |

Tavolo / Table

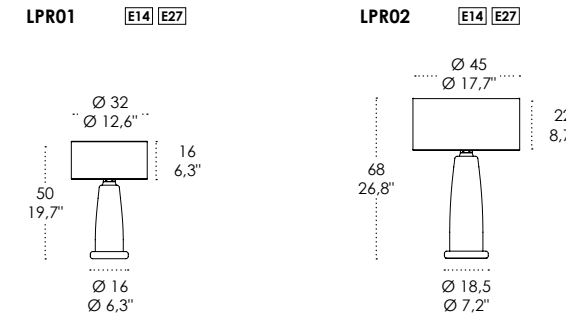

| E14+E27 220-240V IP20 | | | |
|-----------------------|------------------------------------|-----------------|-------------|
| COD. | FINISHES | LAMP CONNECTION | WATT MAX |
| LPR01 | 01B - 06B - 07B 09B - 11B - 13B | E14+E27 | 28 - 70 HS |
| LPR02 | 01B - 06B - 07B 09B - 11B - 13B | E14+E27 | 28 - 105 HS |

Terra / Floor

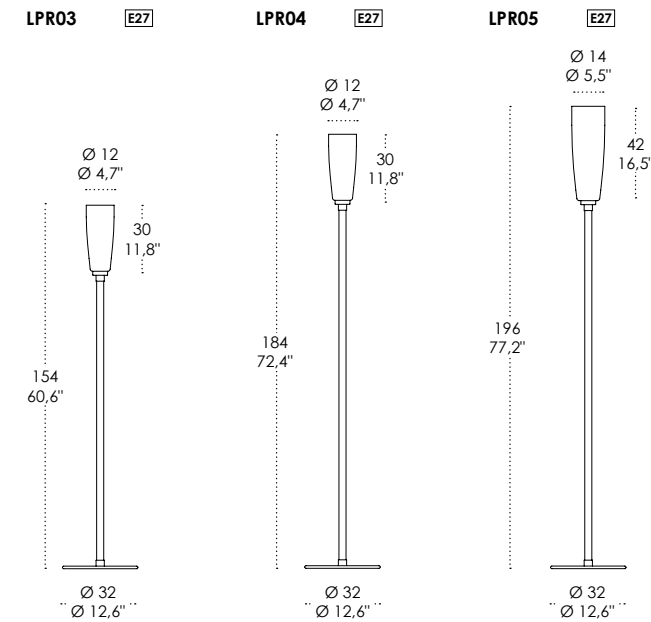

| E27 220-240V IP20 | | | |
|-------------------|------------------------------|-----------------|----------|
| COD. | FINISHES | LAMP CONNECTION | WATT MAX |
| LPR03 | 01 - 06 - 07 09 - 11 - 13 | E27 | 105 HS |
| LPR04 | 01 - 06 - 07 09 - 11 - 13 | E27 | 105 HS |
| LPR05 | 01 - 06 - 07 09 - 11 - 13 | E27 | 105 HS |

MARIPOSA

DESIGN_Federico de Majo





LMR0104



LMR0109

MARIPOSA



Lampade da parete-soffitto con diffusore in vetro in piastra lavorato a mano in diversi colori. La variante con diffusore quadrato è realizzata a mano in vetro artistico di Murano. Struttura in metallo verniciato grigio con dettagli cromati. Mariposa è un prodotto personalizzabile, per colori e finiture, pensato anche per un uso modulare.

Wall-ceiling lamps with handcrafted plate glass diffuser, available in various colours. The version with squared diffuser is handcrafted in traditional Murano glass. Grey painted metal frame with chromed details. Mariposa is a customizable product, both in colours and finishes, designed also for modular use.

Parete-soffitto / Wall-ceiling

Dimmerabile su richiesta / Dimmable on request

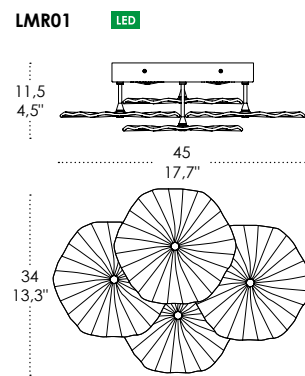

| LED 3000K CRI>80 220-240V IP20 | | | | | |
|--------------------------------|------------------------|---------|---------|------------|------------|
| COD. | FINISHES | W LED | TOTAL W | Lm LED | BEAM ANGLE |
| LMR01 | 01 - 04 - 05 - 09 - 20 | 2 x 4 W | 2 x 4 W | 2 x 420 lm | 120° |

Parete-soffitto / Wall-ceiling

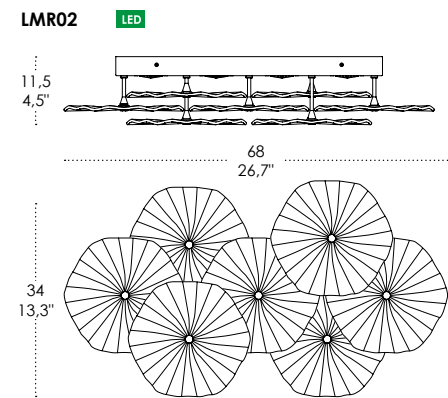

| LED 3000K CRI>80 220-240V IP20 | | | | | |
|--------------------------------|------------------------|---------|---------|------------|------------|
| COD. | FINISHES | W LED | TOTAL W | Lm LED | BEAM ANGLE |
| LMR02 | 01 - 04 - 05 - 09 - 20 | 4 x 4 W | 4 x 4 W | 4 x 420 lm | 120° |

Base per lampada da parete-soffitto / Frame for wall-ceiling lamp

Dimmerabile su richiesta / Dimmable on request

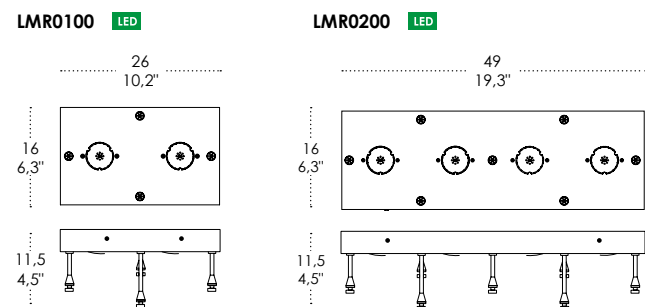

| LED 3000K CRI>80 220-240V IP20 | | | | |
|--------------------------------|---------|---------|------------|------------|
| COD. | W LED | TOTAL W | Lm LED | BEAM ANGLE |
| LMR0100 | 2 x 4 W | 2 x 4 W | 2 x 420 lm | 120° |
| LMR0200 | 4 x 4 W | 4 x 4 W | 4 x 420 lm | 120° |

Supporto per vetro singolo / Support for single glass

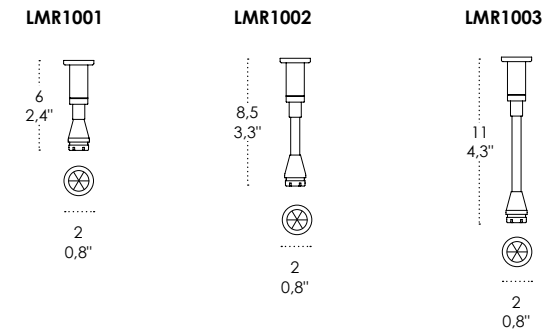

Vetro / Glass element

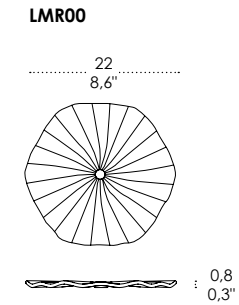
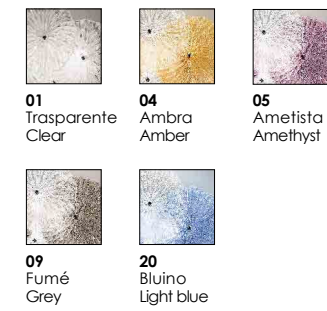

| COD. | FINISHES |
|-------|------------------------|
| LMR00 | 01 - 04 - 05 - 09 - 20 |

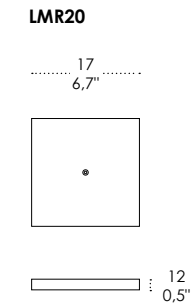

| COD. | FINISHES |
|-------|-------------------|
| LMR20 | 01 - 04 - 05 - 09 |

Esempi di composizione / Example of composition

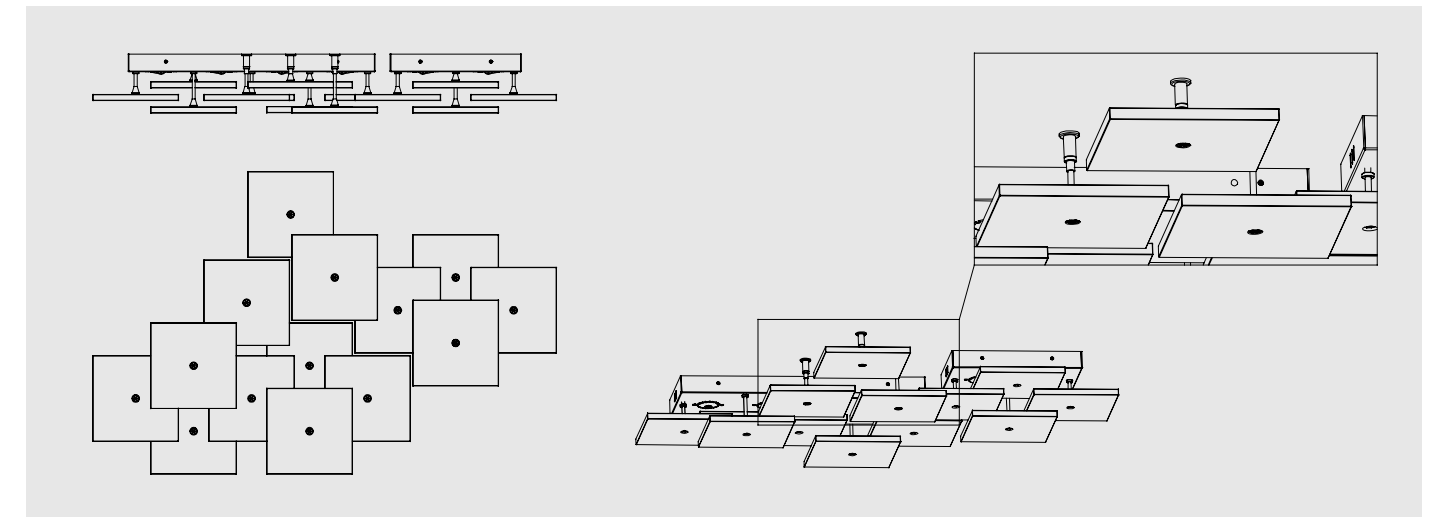



Romeo e Giulietta
Lampade a sospensione
Suspension lamps

Progetto e realizzazione
Design and implementation
Lichtkultur AG / Zurigo

Fotografo / *Photographer*
Markus Vögeli



Onda
Lampadario e applique
Suspension and wall lamps

Residenza privata New Futura 11-02
Private Apartment New Futura 11-02

Interior Contractor
Saporiti Italia

Interior Designer
Studio Ventimiglia con Saporiti AeD

Architetto / *Architect*
Skidmore, Owings & Merrill

Fotografo / *Photographer*
Edward Hendricks, Singapore

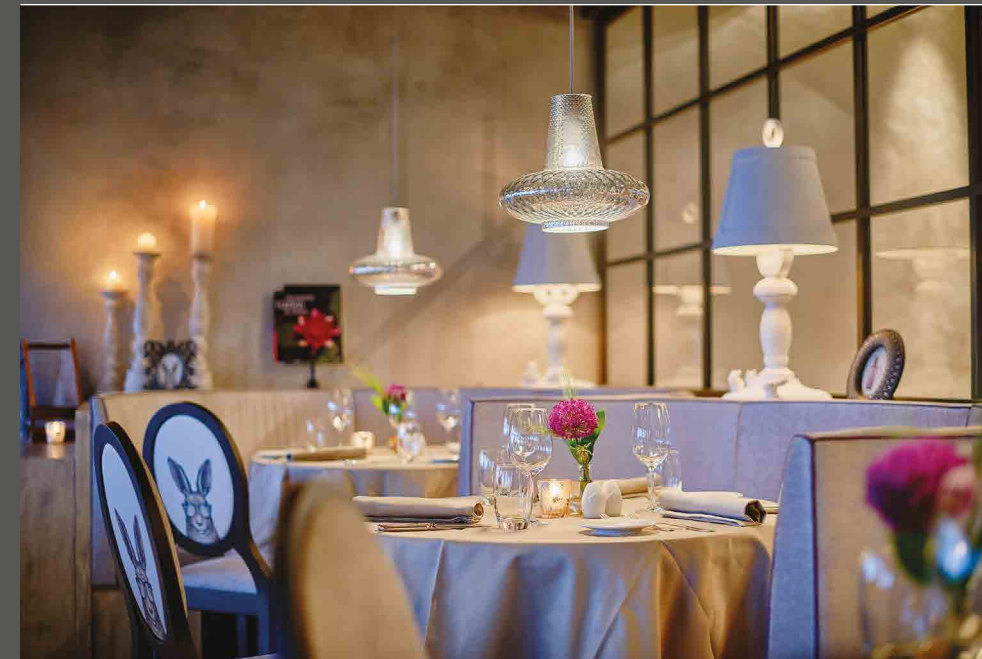

Romeo e Giulietta
Lampade a sospensione
Suspension lamps

Bad Ramsach Quellhotel
Fotografo / *Photographer*
Stöh Grünig

Immagini gentile concessione
Pictures courtesy
Bad Ramsach Quellhotel



Sferis
Lampade a sospensione
Suspension lamps
Hotel Monte Sella
San Vigilio di Marebbe

SEZIONE TECNICA / TECHNICAL SECTION

| | | |
|-----------|----------|---------|
| LD0030B3 | OVALINO | 77 |
| LD0030G3 | OVALINO | 77 |
| LD0040B3 | ASTUCCIO | 81 |
| LD0040G3 | ASTUCCIO | 81 |
| LD0052B3 | CUBETTO | 85 |
| LD0052G3 | CUBETTO | 85 |
| LD0108B3 | RIGA | 51; 117 |
| LD0108G3 | RIGA | 51; 117 |
| LD0109B3 | RIGA | 51; 117 |
| LD0109G3 | RIGA | 51; 117 |
| LD0120B3 | SOLE | 61 |
| LD0120G3 | SOLE | 61 |
| LD0125B3 | SOLE | 61 |
| LD0125G3 | SOLE | 61 |
| LD0127B3 | SOLE | 61 |
| LD0127G3 | SOLE | 61 |
| LD0130B3 | ALU | 29 |
| LD0130G3 | ALU | 29 |
| LD0131B3 | ALU | 29 |
| LD0131G3 | ALU | 29 |
| LD0132B3 | ALU | 29 |
| LD0132G3 | ALU | 29 |
| LD0135B3 | ALU | 29 |
| LD0135G3 | ALU | 29 |
| LD0136B3 | ALU | 29 |
| LD0136G3 | ALU | 29 |
| LD0137B3 | ALU | 29 |
| LD0137G3 | ALU | 29 |
| LD0138B3 | ALU | 29 |
| LD0138G3 | ALU | 29 |
| LD0150B3 | SLAT | 49 |
| LD0150G3 | SLAT | 49 |
| LD0150R3 | SLAT | 49 |
| LD0152B3 | SLAT | 49 |
| LD0152G3 | SLAT | 49 |
| LD0152R3 | SLAT | 49 |
| LD0154G3 | SLAT | 49 |
| LD0155G3 | SLAT | 49 |
| LD0161B3 | TUNNEL | 36 |
| LD0161BFA | TUNNEL | 37 |
| LD0161BFO | TUNNEL | 37 |
| LD0161BFR | TUNNEL | 37 |
| LD0161G3 | TUNNEL | 36 |
| LD0161GFA | TUNNEL | 37 |
| LD0161GFO | TUNNEL | 37 |
| LD0161GFR | TUNNEL | 37 |
| LD0162B3 | TUNNEL | 36 |
| LD0162BFA | TUNNEL | 37 |
| LD0162BFO | TUNNEL | 37 |
| LD0162BFR | TUNNEL | 37 |
| LD0162G3 | TUNNEL | 36 |
| LD0162GFA | TUNNEL | 37 |
| LD0162GFO | TUNNEL | 37 |

| | | |
|-----------|------------|----|
| LD0162GFR | TUNNEL | 37 |
| LD0170B3 | STOLA | 55 |
| LD0170G3 | STOLA | 55 |
| LD0172G3 | STOLA | 55 |
| LD0172R3 | STOLA | 55 |
| LD0180B3 | BIANCA | 65 |
| LD0180G3 | BIANCA | 65 |
| LD0230B3 | BOTTOM | 69 |
| LD0230G3 | BOTTOM | 69 |
| LD0231B3 | BOTTOM | 69 |
| LD0231G3 | BOTTOM | 69 |
| LD0232B3 | BOTTOM | 69 |
| LD0232G3 | BOTTOM | 69 |
| LD0240G3 | TACK | 73 |
| LD0240R3 | TACK | 73 |
| LD0250B3 | HOME | 43 |
| LD0250G3 | HOME | 43 |
| LD0250R3 | HOME | 43 |
| LD0251B3 | HOME | 43 |
| LD0251G3 | HOME | 43 |
| LD0251R3 | HOME | 43 |
| LD0254G3 | HOME | 43 |
| LD0254R3 | HOME | 43 |
| LD0260G3 | GIRASOLE | 71 |
| LD0275B3 | SOTTOSOPRA | 67 |
| LD0275G3 | SOTTOSOPRA | 67 |
| LD0400G3 | SOLAR | 23 |
| LD0402G3 | SOLAR | 23 |
| LD0404G3 | SOLAR | 23 |
| LD0430B3 | CONCHIGLIA | 33 |
| LD0430G3 | CONCHIGLIA | 33 |
| LD0480G3 | CIOTTOLO | 13 |
| LD0480R3 | CIOTTOLO | 13 |
| LD0483G3 | CIOTTOLO | 13 |
| LD0483R3 | CIOTTOLO | 13 |
| LD0485G3 | CIOTTOLO | 13 |
| LD0485R3 | CIOTTOLO | 13 |
| LD0750B3 | LENS | 17 |
| LD0750G3 | LENS | 17 |
| LD0751B3 | LENS | 17 |
| LD0751G3 | LENS | 17 |
| LD0752B3 | LENS | 17 |
| LD0752G3 | LENS | 17 |
| LD0820B3 | GABBIANO | 19 |
| LD0820R3 | GABBIANO | 19 |
| LL0122G3 | SOLE | 57 |
| LL0122R3 | SOLE | 57 |
| LL0124G3 | SOLE | 57 |
| LL0124R3 | SOLE | 57 |
| LL0129G3 | SOLE | 57 |
| LL0129R3 | SOLE | 57 |
| LL0250B3 | HOME | 43 |
| LL0250G3 | HOME | 43 |

| | | |
|----------|------|----|
| LL0250R3 | HOME | 43 |
| LL0251B3 | HOME | 43 |
| LL0251G3 | HOME | 43 |
| LL0251R3 | HOME | 43 |

AI LATI Indoor

| | | |
|----------|----------------|-----|
| LD0001B3 | ECLIPSE TONDA | 121 |
| LD0002B3 | ECLIPSE TONDA | 121 |
| LD0003B3 | ECLIPSE TONDA | 121 |
| LD0004B3 | ECLIPSE QUADRA | 125 |
| LD0005B3 | ECLIPSE TONDA | 121 |
| LD0006B3 | ECLIPSE QUADRA | 125 |
| LD0007B3 | ECLIPSE QUADRA | 125 |
| LD0008B3 | ECLIPSE QUADRA | 125 |
| LD0010B3 | ECLIPSE TONDA | 120 |
| LD0012B3 | ECLIPSE TONDA | 120 |
| LD0013B3 | ECLIPSE QUADRA | 124 |
| LD0015B3 | ECLIPSE QUADRA | 124 |
| LD0016B3 | ECLIPSE TONDA | 120 |
| LD0017B3 | ECLIPSE TONDA | 120 |
| LD0018B3 | ECLIPSE QUADRA | 124 |
| LD0019B3 | ECLIPSE QUADRA | 124 |
| LD0050B3 | CUBETTO | 127 |
| LD0050S3 | CUBETTO | 127 |
| LD0051B3 | CUBETTO | 127 |
| LD0051S3 | CUBETTO | 127 |
| LD0061B3 | CIP | 129 |
| LD0062B3 | CIP | 129 |
| LD0070B3 | STRIPE | 103 |
| LD0070S3 | STRIPE | 103 |
| LD0071B3 | STRIPE | 103 |
| LD0071S3 | STRIPE | 103 |
| LD0072B3 | STRIPE | 103 |
| LD0072S3 | STRIPE | 103 |
| LD0076B3 | STRIPE MAGNETO | 105 |
| LD0076S3 | STRIPE MAGNETO | 105 |
| LD0077B3 | STRIPE MAGNETO | 105 |
| LD0077S3 | STRIPE MAGNETO | 105 |
| LD0079B3 | STRIPE | 101 |
| LD0080B3 | BRIDGE | 131 |
| LD0081B3 | BRIDGE | 131 |
| LD0090B3 | MINE | 139 |
| LD0090N3 | MINE | 139 |
| LD0091B3 | MINE | 139 |
| LD0091N3 | MINE | 139 |
| LD0092B3 | MINE | 139 |
| LD0092N3 | MINE | 139 |
| LD0101B3 | RIGA | 117 |
| LD0102B3 | RIGA | 117 |
| LD0140B3 | CONCA | 111 |
| LD0141B3 | CONCA | 111 |
| LD0142B3 | CONCA | 111 |

| | | |
|-----------|---------|-----|
| LD0143B3 | CONCA | 111 |
| LD0146B3 | CONCA | 111 |
| LD0147B3 | CONCA | 111 |
| LD0148B3 | CONCA | 111 |
| LD0190B3 | CALEIDO | 135 |
| LD0190G3 | CALEIDO | 135 |
| LD0192B3 | CALEIDO | 135 |
| LD0192G3 | CALEIDO | 135 |
| LD0194B3 | CALEIDO | 135 |
| LD0194G3 | CALEIDO | 135 |
| LD0196B3 | CALEIDO | 135 |
| LD0196G3 | CALEIDO | 135 |
| LD0197B3 | CALEIDO | 135 |
| LD0197G3 | CALEIDO | 135 |
| LD0198B3 | CALEIDO | 135 |
| LD0198G3 | CALEIDO | 135 |
| LD0199B3 | CALEIDO | 135 |
| LD0199G3 | CALEIDO | 135 |
| LD0370B3 | STRIPE | 98 |
| LD0371B3 | STRIPE | 98 |
| LD0373B3 | STRIPE | 99 |
| LD0374B3 | STRIPE | 99 |
| LD0375B3 | STRIPE | 99 |
| LD0377B3 | STRIPE | 100 |
| LD0378B3 | STRIPE | 100 |
| LD110203B | MENTOS | 154 |
| LD110234B | MENTOS | 154 |
| LD110235B | MENTOS | 154 |
| LD110236B | MENTOS | 154 |
| LD110303B | MENTOS | 154 |
| LD110343B | MENTOS | 154 |
| LD110353B | MENTOS | 154 |
| LD110363B | MENTOS | 154 |
| LD110373B | MENTOS | 154 |
| LD110403B | MENTOS | 154 |
| LD110443B | MENTOS | 154 |
| LD110453B | MENTOS | 154 |
| LD110463B | MENTOS | 154 |
| LD110473B | MENTOS | 154 |
| LD112203B | MENTOS | 155 |
| LD112233B | MENTOS | 155 |
| LD112243B | MENTOS | 155 |
| LD112253B | MENTOS | 155 |
| LD113303B | MENTOS | 155 |
| LD113333B | MENTOS | 155 |
| LD113343B | MENTOS | 155 |
| LD113353B | MENTOS | 155 |
| LD114403B | MENTOS | 155 |
| LD114433B | MENTOS | 155 |
| LD114443B | MENTOS | 155 |
| LD114453B | MENTOS | 155 |
| LD120103B | TREVISO | 150 |
| LD120103G | TREVISO | 150 |

| | | |
|-----------|---------|-----|
| LD120103N | TREVISO | 150 |
| LD120113B | TREVISO | 151 |
| LD120113G | TREVISO | 151 |
| LD120113N | TREVISO | 151 |
| LD120123B | TREVISO | 151 |
| LD120123G | TREVISO | 151 |
| LD120123N | TREVISO | 151 |
| LD120133B | TREVISO | 151 |
| LD120133G | TREVISO | 151 |
| LD120133N | TREVISO | 151 |
| LD120203B | TREVISO | 150 |
| LD120203G | TREVISO | 150 |
| LD120203N | TREVISO | 150 |
| LD120213B | TREVISO | 151 |
| LD120213G | TREVISO | 151 |
| LD120213N | TREVISO | 151 |
| LD120223B | TREVISO | 151 |
| LD120223G | TREVISO | 151 |
| LD120223N | TREVISO | 151 |
| LD120233B | TREVISO | 151 |
| LD120233G | TREVISO | 151 |
| LD120233N | TREVISO | 151 |
| LD120303B | TREVISO | 150 |
| LD120303G | TREVISO | 150 |
| LD120303N | TREVISO | 150 |
| LD120313B | TREVISO | 151 |
| LD120313G | TREVISO | 151 |
| LD120313N | TREVISO | 151 |
| LD120323B | TREVISO | 151 |
| LD120323G | TREVISO | 151 |
| LD120323N | TREVISO | 151 |
| LD120333B | TREVISO | 151 |
| LD120333G | TREVISO | 151 |
| LD120333N | TREVISO | 151 |
| LD120403B | TREVISO | 150 |
| LD120403G | TREVISO | 150 |
| LD120403N | TREVISO | 150 |
| LD121103B | TREVISO | 148 |
| LD121103G | TREVISO | 148 |
| LD121103N | TREVISO | 148 |
| LD121113B | TREVISO | 149 |
| LD121113G | TREVISO | 149 |
| LD121113N | TREVISO | 149 |
| LD121123B | TREVISO | 149 |
| LD121123G | TREVISO | 149 |
| LD121123N | TREVISO | 149 |
| LD121133B | TREVISO | 149 |
| LD121133G | TREVISO | 149 |
| LD121133N | TREVISO | 149 |
| LD121203B | TREVISO | 148 |
| LD121203G | TREVISO | 148 |
| LD121203N | TREVISO | 148 |
| LD121213B | TREVISO | 149 |

| | | |
|-----------|---------|-----|
| LD121213G | TREVISO | 149 |
| LD121213N | TREVISO | 149 |
| LD121223B | TREVISO | 149 |
| LD121223G | TREVISO | 149 |
| LD121223N | TREVISO | 149 |
| LD121233B | TREVISO | 149 |
| LD121233G | TREVISO | 149 |
| LD121233N | TREVISO | 149 |
| LD121303B | TREVISO | 148 |
| LD121303G | TREVISO | 148 |
| LD121303N | TREVISO | 148 |
| LD121313B | TREVISO | 149 |
| LD121313G | TREVISO | 149 |
| LD121313N | TREVISO | 149 |
| LD121323B | TREVISO | 149 |
| LD121323G | TREVISO | 149 |
| LD121323N | TREVISO | 149 |
| LD121333B | TREVISO | 149 |
| LD121333G | TREVISO | 149 |
| LD121333N | TREVISO | 149 |
| LD121403B | TREVISO | 148 |
| LD121403G | TREVISO | 148 |
| LD121403N | TREVISO | 148 |
| LD124203B | TREVISO | 149 |
| LD124203G | TREVISO | 149 |
| LD124203N | TREVISO | 149 |
| LD124303B | TREVISO | 149 |
| LD124303G | TREVISO | 149 |
| LD124303N | TREVISO | 149 |
| LD127203B | TREVISO | 151 |
| LD127203G | TREVISO | 151 |
| LD127203N | TREVISO | 151 |
| LD127303B | TREVISO | 151 |
| LD127303G | TREVISO | 151 |
| LD127303N | TREVISO | 151 |
| LD1301B3 | LUCCA | 181 |
| LD1301G3 | LUCCA | 181 |
| LD1301N3 | LUCCA | 181 |
| LD1302B3 | LUCCA | 181 |
| LD1302G3 | LUCCA | 181 |
| LD1302N3 | LUCCA | 181 |
| LD1303B3 | LUCCA | 181 |
| LD1303G3 | LUCCA | 181 |
| LD1303N3 | LUCCA | 181 |
| LD130403 | CAORLE | 171 |
| LD130503 | CAORLE | 171 |
| LD130513 | CAORLE | 171 |
| LD130523 | CAORLE | 171 |
| LD130533 | CAORLE | 171 |
| LD130603 | CAORLE | 171 |
| LD130613 | CAORLE | 171 |
| LD130623 | CAORLE | 171 |
| LD130633 | CAORLE | 171 |

| | | |
|------------|-------------|-----|
| LD1313B3 | LUCCA | 181 |
| LD1313G3 | LUCCA | 181 |
| LD1313N3 | LUCCA | 181 |
| LD1323B3 | LUCCA | 181 |
| LD1323G3 | LUCCA | 181 |
| LD1323N3 | LUCCA | 181 |
| LD1333B3 | LUCCA | 181 |
| LD1333G3 | LUCCA | 181 |
| LD1333N3 | LUCCA | 181 |
| LD133603 | CAORLE | 171 |
| LD2002B | DADO | 169 |
| LD2002C | DADO | 169 |
| LD2004B | DADO | 169 |
| LD2004C | DADO | 169 |
| LD2022B | DADO | 169 |
| LD2022C | DADO | 169 |
| LD2024B | DADO | 169 |
| LD2024C | DADO | 169 |
| LD300103 | STAND | 183 |
| LD3001B3 | STAND METAL | 185 |
| LD3001C3 | STAND METAL | 185 |
| LD302003 | RIALTO | 175 |
| LD302013 | RIALTO | 175 |
| LD302023 | RIALTO | 175 |
| LD302033 | RIALTO | 175 |
| LD303003 | RIALTO | 175 |
| LD303013 | RIALTO | 175 |
| LD303023 | RIALTO | 175 |
| LD303033 | RIALTO | 175 |
| LD304003 | RIALTO | 175 |
| LD306003 | RIALTO | 175 |
| LD307003 | RIALTO | 175 |
| LD309103 | RIALTO | 175 |
| LD309203 | RIALTO | 175 |
| LD5000 | SPICCHIO | 201 |
| LD550003 | CHIUUSA | 203 |
| LD550103 | CHIUUSA | 203 |
| LD611003 | BIS BAYONET | 213 |
| LD611103 | BIS BAYONET | 213 |
| LD611113 | BIS BAYONET | 213 |
| LD61113NE | BIS | 211 |
| LD611123 | BIS BAYONET | 213 |
| LD611123NE | BIS | 211 |
| LD611133 | BIS BAYONET | 213 |
| LD611133NE | BIS | 211 |
| LD6111NE | BIS | 211 |
| LD611203 | BIS BAYONET | 213 |
| LD611213 | BIS BAYONET | 213 |
| LD611213NE | BIS | 211 |
| LD611223 | BIS BAYONET | 213 |
| LD611223NE | BIS | 211 |
| LD611233 | BIS BAYONET | 213 |
| LD611233NE | BIS | 211 |

| | | |
|------------|--------------|-----|
| LD6112NE | BIS | 211 |
| LD611303 | BIS BAYONET | 213 |
| LD611313 | BIS BAYONET | 213 |
| LD611313NE | BIS | 211 |
| LD611323 | BIS BAYONET | 213 |
| LD611323NE | BIS | 211 |
| LD611333 | BIS BAYONET | 213 |
| LD611333NE | BIS | 211 |
| LD6113NE | BIS | 211 |
| LD612603 | BIS BAYONET | 213 |
| LD612603NE | BIS | 211 |
| LD612703 | BIS BAYONET | 213 |
| LD612703NE | BIS | 211 |
| LD6501B3 | STICK 6555 | 199 |
| LD6502B3 | STICK 6555 | 199 |
| LD8411AR3 | BOX ROTONDA | 215 |
| LD8411BL3 | BOX ROTONDA | 215 |
| LD8411GI3 | BOX ROTONDA | 215 |
| LD8411NE3 | BOX ROTONDA | 215 |
| LD8411RO3 | BOX ROTONDA | 215 |
| LD8411VE3 | BOX ROTONDA | 215 |
| LD8421AR3 | BOX ROTONDA | 215 |
| LD8421BL3 | BOX ROTONDA | 215 |
| LD8421GI3 | BOX ROTONDA | 215 |
| LD8421NE3 | BOX ROTONDA | 215 |
| LD8421RO3 | BOX ROTONDA | 215 |
| LD8421VE3 | BOX ROTONDA | 215 |
| LD8431AR3 | BOX ROTONDA | 215 |
| LD8431BL3 | BOX ROTONDA | 215 |
| LD8431GI3 | BOX ROTONDA | 215 |
| LD8431NE3 | BOX ROTONDA | 215 |
| LD8431RO3 | BOX ROTONDA | 215 |
| LD8431VE3 | BOX ROTONDA | 215 |
| LD8441AR3 | BOX ROTONDA | 215 |
| LD8441BL3 | BOX ROTONDA | 215 |
| LD8441GI3 | BOX ROTONDA | 215 |
| LD8441NE3 | BOX ROTONDA | 215 |
| LD8441RO3 | BOX ROTONDA | 215 |
| LD8441VE3 | BOX ROTONDA | 215 |
| LD8461AR3 | BOX QUADRATA | 217 |
| LD8461BL3 | BOX QUADRATA | 217 |
| LD8461GI3 | BOX QUADRATA | 217 |
| LD8461NE3 | BOX QUADRATA | 217 |
| LD8461RO3 | BOX QUADRATA | 217 |
| LD8461VE3 | BOX QUADRATA | 217 |
| LD8471AR3 | BOX QUADRATA | 217 |
| LD8471BL3 | BOX QUADRATA | 217 |
| LD8471GI3 | BOX QUADRATA | 217 |
| LD8471NE3 | BOX QUADRATA | 217 |
| LD8471RO3 | BOX QUADRATA | 217 |
| LD8471VE3 | BOX QUADRATA | 217 |
| LD8481AR3 | BOX QUADRATA | 217 |
| LD8481BL3 | BOX QUADRATA | 217 |

| | | |
|------------|--------------|-----|
| LD8481GI3 | BOX QUADRATA | 217 |
| LD8481NE3 | BOX QUADRATA | 217 |
| LD8481RO3 | BOX QUADRATA | 217 |
| LD8481VE3 | BOX QUADRATA | 217 |
| LD8491AR3 | BOX QUADRATA | 217 |
| LD8491BL3 | BOX QUADRATA | 217 |
| LD8491GI3 | BOX QUADRATA | 217 |
| LD8491NE3 | BOX QUADRATA | 217 |
| LD8491RO3 | BOX QUADRATA | 217 |
| LD8491VE3 | BOX QUADRATA | 217 |
| LD870113B3 | DRUM METAL | 207 |
| LD870113C3 | DRUM METAL | 207 |
| LD870113N3 | DRUM | 205 |
| LD870123B3 | DRUM METAL | 207 |
| LD870123C3 | DRUM METAL | 207 |
| LD870123N3 | DRUM | 205 |
| LD870133B3 | DRUM METAL | 207 |
| LD870133C3 | DRUM METAL | 207 |
| LD870133N3 | DRUM | 205 |
| LD8701B3 | DRUM METAL | 207 |
| LD8701C3 | DRUM METAL | 207 |
| LD8701N3 | DRUM | 205 |
| LD873113B3 | DRUM METAL | 207 |
| LD873113C3 | DRUM METAL | 207 |
| LD873113N3 | DRUM | 205 |
| LD873123B3 | DRUM METAL | 207 |
| LD873123C3 | DRUM METAL | 207 |
| LD873123N3 | DRUM | 205 |
| LD873133B3 | DRUM METAL | 207 |
| LD873133C3 | DRUM METAL | 207 |
| LD873133N3 | DRUM | 205 |
| LD8731B3 | DRUM METAL | 207 |
| LD8731C3 | DRUM METAL | 207 |
| LD8731N3 | DRUM | 205 |
| LD8742N3 | DRUM | 205 |
| LD8743B3 | DRUM METAL | 207 |
| LD8743C3 | DRUM METAL | 207 |
| LD8745B3 | DRUM METAL | 207 |
| LD8745C3 | DRUM METAL | 207 |
| LD876113B3 | DRUM METAL | 207 |
| LD876113C3 | DRUM METAL | 207 |
| LD876113N3 | DRUM | 205 |
| LD876123B3 | DRUM METAL | 207 |
| LD876123C3 | DRUM METAL | 207 |
| LD876123N3 | DRUM | 205 |
| LD876133B3 | DRUM METAL | 207 |
| LD876133C3 | DRUM METAL | 207 |
| LD876133N3 | DRUM | 205 |
| LD8761B3 | DRUM METAL | 207 |
| LD8761C3 | DRUM METAL | 207 |
| LD8761N3 | DRUM | 205 |
| LD8772N3 | DRUM | 205 |
| LD891003 | DRUM BAYONET | 209 |

| | | |
|-----------|--------------|-----|
| LD891013 | DRUM BAYONET | 209 |
| LD891023 | DRUM BAYONET | 209 |
| LD891033 | DRUM BAYONET | 209 |
| LD891103 | DRUM BAYONET | 209 |
| LD891113 | DRUM BAYONET | 209 |
| LD891123 | DRUM BAYONET | 209 |
| LD891133 | DRUM BAYONET | 209 |
| LD891203 | DRUM BAYONET | 209 |
| LD891213 | DRUM BAYONET | 209 |
| LD891223 | DRUM BAYONET | 209 |
| LD891233 | DRUM BAYONET | 209 |
| LD891303 | DRUM BAYONET | 209 |
| LD894103 | DRUM BAYONET | 209 |
| LD894203 | DRUM BAYONET | 209 |
| LD9511C3 | STICK 65 | 198 |
| LD9515C3 | STICK 65 | 198 |
| LD9517C3 | STICK 65 | 198 |
| LD9521C3 | STICK 65 | 198 |
| LD9525C3 | STICK 65 | 198 |
| LD9527C3 | STICK 65 | 198 |
| LD9566C3 | OMEGA | 187 |
| LD9591B3 | STICK 80 | 199 |
| LD9592B3 | STICK 80 | 199 |
| LD9593B3 | STICK 80 | 199 |
| LL0830B3 | RASO | 107 |
| LL0831B3 | RASO | 107 |
| LL120103B | TREVISO | 150 |
| LL120103G | TREVISO | 150 |
| LL120103N | TREVISO | 150 |
| LL120203B | TREVISO | 150 |
| LL120203G | TREVISO | 150 |
| LL120203N | TREVISO | 150 |
| LL120303B | TREVISO | 150 |
| LL120303G | TREVISO | 150 |
| LL120303N | TREVISO | 150 |
| LL120403B | TREVISO | 150 |
| LL120403G | TREVISO | 150 |
| LL120403N | TREVISO | 150 |
| LL121103B | TREVISO | 148 |
| LL121103G | TREVISO | 148 |
| LL121103N | TREVISO | 148 |
| LL121203B | TREVISO | 148 |
| LL121203G | TREVISO | 148 |
| LL121203N | TREVISO | 148 |
| LL121303B | TREVISO | 148 |
| LL121303G | TREVISO | 148 |
| LL121303N | TREVISO | 148 |
| LL121403B | TREVISO | 148 |
| LL121403G | TREVISO | 148 |
| LL121403N | TREVISO | 148 |
| LL1301B | LUCCA | 181 |
| LL1301G | LUCCA | 181 |
| LL1301N | LUCCA | 181 |

| | | |
|------------|-------------|-----|
| LL1302B | LUCCA | 181 |
| LL1302G | LUCCA | 181 |
| LL1302N | LUCCA | 181 |
| LL1303B | LUCCA | 181 |
| LL1303G | LUCCA | 181 |
| LL1303N | LUCCA | 181 |
| LL1304 | CAORLE | 171 |
| LL1305 | CAORLE | 171 |
| LL1306 | CAORLE | 171 |
| LL2002B | DADO | 169 |
| LL2002C | DADO | 169 |
| LL2004B | DADO | 169 |
| LL2004C | DADO | 169 |
| LL2022B | DADO | 169 |
| LL2022C | DADO | 169 |
| LL2024B | DADO | 169 |
| LL2024C | DADO | 169 |
| LL3001 | STAND | 183 |
| LL3001B | STAND METAL | 185 |
| LL3001C | STAND METAL | 185 |
| LL3020 | RIALTO | 175 |
| LL3030 | RIALTO | 175 |
| LL3040 | RIALTO | 175 |
| LL3060 | RIALTO | 175 |
| LL3070 | RIALTO | 175 |
| LL4100 | SFERIS | 159 |
| LL410013 | SFERIS | 160 |
| LL410013B | SFERIS | 160 |
| LL410013N | SFERIS | 160 |
| LL410013O3 | SFERIS | 160 |
| LL410030 | SFERIS | 160 |
| LL410030B | SFERIS | 160 |
| LL410030N | SFERIS | 160 |
| LL410030O3 | SFERIS | 160 |
| LL410050 | SFERIS | 160 |
| LL410050B | SFERIS | 160 |
| LL410050N | SFERIS | 160 |
| LL410050O3 | SFERIS | 160 |
| LL4100B | SFERIS | 159 |
| LL4100N | SFERIS | 159 |
| LL4100O3 | SFERIS | 159 |
| LL4101 | SFERIS | 159 |
| LL410113 | SFERIS | 160 |
| LL410113B | SFERIS | 160 |
| LL410113N | SFERIS | 160 |
| LL410113O3 | SFERIS | 160 |
| LL410130 | SFERIS | 160 |
| LL410130B | SFERIS | 160 |
| LL410130N | SFERIS | 160 |
| LL410130O3 | SFERIS | 160 |
| LL410150 | SFERIS | 160 |
| LL410150B | SFERIS | 160 |
| LL410150N | SFERIS | 160 |

| | | |
|------------|--------|-----|
| LL410150O3 | SFERIS | 160 |
| LL4101B | SFERIS | 159 |
| LL4101N | SFERIS | 159 |
| LL4101O3 | SFERIS | 159 |
| LL4103 | SFERIS | 159 |
| LL410313 | SFERIS | 160 |
| LL410313B | SFERIS | 160 |
| LL410313N | SFERIS | 160 |
| LL410313O3 | SFERIS | 160 |
| LL410330 | SFERIS | 160 |
| LL410330B | SFERIS | 160 |
| LL410330N | SFERIS | 160 |
| LL410330O3 | SFERIS | 160 |
| LL410350 | SFERIS | 160 |
| LL410350B | SFERIS | 160 |
| LL410350N | SFERIS | 160 |
| LL410350O3 | SFERIS | 160 |
| LL4103B | SFERIS | 159 |
| LL4103N | SFERIS | 159 |
| LL4103O3 | SFERIS | 159 |
| LL4111 | SFERIS | 159 |
| LL411113 | SFERIS | 161 |
| LL411113B | SFERIS | 161 |
| LL411113N | SFERIS | 161 |
| LL411113O3 | SFERIS | 161 |
| LL411130 | SFERIS | 161 |
| LL411130B | SFERIS | 161 |
| LL411130N | SFERIS | 161 |
| LL411130O3 | SFERIS | 161 |
| LL411150 | SFERIS | 161 |
| LL411150B | SFERIS | 161 |
| LL411150N | SFERIS | 161 |
| LL411150O3 | SFERIS | 161 |
| LL4111B | SFERIS | 159 |
| LL4111N | SFERIS | 159 |
| LL4111O3 | SFERIS | 159 |
| LL4112 | SFERIS | 159 |
| LL4112B | SFERIS | 159 |
| LL4112N | SFERIS | 159 |
| LL4112O3 | SFERIS | 159 |
| LL4200 | SFERIS | 159 |
| LL4200B | SFERIS | 159 |
| LL4200N | SFERIS | 159 |
| LL4200O3 | SFERIS | 159 |
| LL4201 | SFERIS | 159 |
| LL4201B | SFERIS | 159 |
| LL4201N | SFERIS | 159 |
| LL4201O3 | SFERIS | 159 |
| LL4203 | SFERIS | 159 |
| LL4203B | SFERIS | 159 |
| LL4203N | SFERIS | 159 |
| LL4203O3 | SFERIS | 159 |
| LL4210 | SFERIS | 159 |

| | | |
|----------|--------------|-----|
| LL4210B | SFERIS | 159 |
| LL4210N | SFERIS | 159 |
| LL4210OS | SFERIS | 159 |
| LL4300B | SFERIS | 161 |
| LL4300N | SFERIS | 161 |
| LL4301B | SFERIS | 161 |
| LL4301N | SFERIS | 161 |
| LL4303B | SFERIS | 161 |
| LL4303N | SFERIS | 161 |
| LL5001 | SPICCHIO | 201 |
| LL5500 | CHIUSA | 203 |
| LL5501 | CHIUSA | 203 |
| LL6110 | BIS BAYONET | 213 |
| LL6111 | BIS BAYONET | 213 |
| LL6111NE | BIS | 211 |
| LL6112 | BIS BAYONET | 213 |
| LL6112NE | BIS | 211 |
| LL6113 | BIS BAYONET | 213 |
| LL6113NE | BIS | 211 |
| LL8411AR | BOX ROTONDA | 215 |
| LL8411BL | BOX ROTONDA | 215 |
| LL8411GI | BOX ROTONDA | 215 |
| LL8411NE | BOX ROTONDA | 215 |
| LL8411RO | BOX ROTONDA | 215 |
| LL8411VE | BOX ROTONDA | 215 |
| LL8461AR | BOX QUADRATA | 217 |
| LL8461BL | BOX QUADRATA | 217 |
| LL8461GI | BOX QUADRATA | 217 |
| LL8461NE | BOX QUADRATA | 217 |
| LL8461RO | BOX QUADRATA | 217 |
| LL8461VE | BOX QUADRATA | 217 |
| LL8701B | DRUM METAL | 207 |
| LL8701C | DRUM METAL | 207 |
| LL8701NE | DRUM | 205 |
| LL8731B | DRUM METAL | 207 |
| LL8731C | DRUM METAL | 207 |
| LL8731NE | DRUM | 205 |
| LL8761B | DRUM METAL | 207 |
| LL8761C | DRUM METAL | 207 |
| LL8761NE | DRUM | 205 |
| LL8910 | DRUM BAYONET | 209 |
| LL8911 | DRUM BAYONET | 209 |
| LL8912 | DRUM BAYONET | 209 |
| LL8913 | DRUM BAYONET | 209 |
| LL9511 | STICK 65 | 198 |
| LL9521 | STICK 65 | 198 |
| LL9610 | STICK 100 | 195 |
| LL961013 | STICK 100 | 196 |
| LL961030 | STICK 100 | 196 |
| LL961050 | STICK 100 | 196 |
| LL9610B | STICK 100 | 195 |
| LL9710 | STICK 150 | 195 |
| LL971013 | STICK 150 | 196 |

| | | |
|----------|-----------|-----|
| LL971030 | STICK 150 | 196 |
| LL971050 | STICK 150 | 196 |
| LL9710B | STICK 150 | 195 |
| LL9821 | STICK 240 | 195 |
| LL982113 | STICK 240 | 197 |
| LL982130 | STICK 240 | 197 |
| LL982150 | STICK 240 | 197 |
| LL9821B | STICK 240 | 195 |
| LL9827 | STICK 240 | 195 |
| LL982713 | STICK 240 | 197 |
| LL982730 | STICK 240 | 197 |
| LL982750 | STICK 240 | 197 |
| LL9827B | STICK 240 | 195 |
| LL9916 | PALLINA | 165 |
| LL9917 | PALLINA | 165 |
| LL9918 | PALLINA | 165 |
| LL9919 | PALLINA | 165 |
| LL9920 | PALLINA | 165 |
| LL9921 | PALLINA | 165 |
| LSX0101 | SIXTIES | 143 |
| LSX1101 | SIXTIES | 143 |
| LSX2101 | SIXTIES | 143 |

ZAFFERANO BESPOKE

| | | |
|---------|---------|-----|
| LBB0104 | BALLOON | 249 |
| LBB0105 | BALLOON | 249 |
| LBB0107 | BALLOON | 249 |
| LBB0109 | BALLOON | 249 |
| LBB0111 | BALLOON | 249 |
| LBB0120 | BALLOON | 249 |
| LBB0204 | BALLOON | 249 |
| LBB0205 | BALLOON | 249 |
| LBB0207 | BALLOON | 249 |
| LBB0209 | BALLOON | 249 |
| LBB0211 | BALLOON | 249 |
| LBB0220 | BALLOON | 249 |
| LBB1104 | BALLOON | 249 |
| LBB1105 | BALLOON | 249 |
| LBB1107 | BALLOON | 249 |
| LBB1109 | BALLOON | 249 |
| LBB1111 | BALLOON | 249 |
| LBB1120 | BALLOON | 249 |
| LBB1204 | BALLOON | 249 |
| LBB1205 | BALLOON | 249 |
| LBB1207 | BALLOON | 249 |
| LBB1209 | BALLOON | 249 |
| LBB1211 | BALLOON | 249 |
| LBB1220 | BALLOON | 249 |
| LBB2104 | BALLOON | 249 |
| LBB2105 | BALLOON | 249 |
| LBB2107 | BALLOON | 249 |
| LBB2109 | BALLOON | 249 |

| | | |
|---------|---------|-----|
| LBB2111 | BALLOON | 249 |
| LBB2120 | BALLOON | 249 |
| LBB2204 | BALLOON | 249 |
| LBB2205 | BALLOON | 249 |
| LBB2207 | BALLOON | 249 |
| LBB2209 | BALLOON | 249 |
| LBB2211 | BALLOON | 249 |
| LBB2220 | BALLOON | 249 |
| LBN0101 | BONNIE | 269 |
| LBN0104 | BONNIE | 269 |
| LBN0105 | BONNIE | 269 |
| LBN0109 | BONNIE | 269 |
| LBN0120 | BONNIE | 269 |
| LBN0121 | BONNIE | 269 |
| LBN0122 | BONNIE | 269 |
| LBN0123 | BONNIE | 269 |
| LBN0124 | BONNIE | 269 |
| LBN1101 | BONNIE | 269 |
| LBN1104 | BONNIE | 269 |
| LBN1105 | BONNIE | 269 |
| LBN1109 | BONNIE | 269 |
| LBN1120 | BONNIE | 269 |
| LBN1121 | BONNIE | 269 |
| LBN1122 | BONNIE | 269 |
| LBN1123 | BONNIE | 269 |
| LBN1124 | BONNIE | 269 |
| LBN2101 | BONNIE | 269 |
| LBN2104 | BONNIE | 269 |
| LBN2105 | BONNIE | 269 |
| LBN2109 | BONNIE | 269 |
| LBN2120 | BONNIE | 269 |
| LBN2121 | BONNIE | 269 |
| LBN2122 | BONNIE | 269 |
| LBN2123 | BONNIE | 269 |
| LBN2124 | BONNIE | 269 |
| LBR0104 | BALLOON | 248 |
| LBR0105 | BALLOON | 248 |
| LBR0107 | BALLOON | 248 |
| LBR0109 | BALLOON | 248 |
| LBR0111 | BALLOON | 248 |
| LBR0120 | BALLOON | 248 |
| LBR0204 | BALLOON | 248 |
| LBR0205 | BALLOON | 248 |
| LBR0207 | BALLOON | 248 |
| LBR0209 | BALLOON | 248 |
| LBR0211 | BALLOON | 248 |
| LBR0220 | BALLOON | 248 |
| LBR1104 | BALLOON | 248 |
| LBR1105 | BALLOON | 248 |
| LBR1107 | BALLOON | 248 |
| LBR1109 | BALLOON | 248 |
| LBR1111 | BALLOON | 248 |
| LBR1120 | BALLOON | 248 |

| | | |
|----------|------------|-----|
| LBR1204 | BALLOON | 248 |
| LBR1205 | BALLOON | 248 |
| LBR1207 | BALLOON | 248 |
| LBR1209 | BALLOON | 248 |
| LBR1211 | BALLOON | 248 |
| LBR1220 | BALLOON | 248 |
| LBR2104 | BALLOON | 248 |
| LBR2105 | BALLOON | 248 |
| LBR2107 | BALLOON | 248 |
| LBR2109 | BALLOON | 248 |
| LBR2111 | BALLOON | 248 |
| LBR2120 | BALLOON | 248 |
| LBR2204 | BALLOON | 248 |
| LBR2205 | BALLOON | 248 |
| LBR2207 | BALLOON | 248 |
| LBR2209 | BALLOON | 248 |
| LBR2211 | BALLOON | 248 |
| LBR2220 | BALLOON | 248 |
| LCL0101 | CLYDE | 269 |
| LCL0104 | CLYDE | 269 |
| LCL0105 | CLYDE | 269 |
| LCL0109 | CLYDE | 269 |
| LCL0120 | CLYDE | 269 |
| LCL0121 | CLYDE | 269 |
| LCL0122 | CLYDE | 269 |
| LCL0123 | CLYDE | 269 |
| LCL0124 | CLYDE | 269 |
| LCL1101 | CLYDE | 269 |
| LCL1104 | CLYDE | 269 |
| LCL1105 | CLYDE | 269 |
| LCL1109 | CLYDE | 269 |
| LCL1120 | CLYDE | 269 |
| LCL1121 | CLYDE | 269 |
| LCL1122 | CLYDE | 269 |
| LCL1123 | CLYDE | 269 |
| LCL1124 | CLYDE | 269 |
| LCL2101 | CLYDE | 269 |
| LCL2104 | CLYDE | 269 |
| LCL2105 | CLYDE | 269 |
| LCL2109 | CLYDE | 269 |
| LCL2120 | CLYDE | 269 |
| LCL2121 | CLYDE | 269 |
| LCL2122 | CLYDE | 269 |
| LCL2123 | CLYDE | 269 |
| LCL2124 | CLYDE | 269 |
| LD0500B3 | CAMOUFLAGE | 230 |
| LD0500G3 | CAMOUFLAGE | 230 |
| LD0500S3 | CAMOUFLAGE | 230 |
| LD0501B3 | CAMOUFLAGE | 229 |
| LD0501G3 | CAMOUFLAGE | 229 |
| LD0501S3 | CAMOUFLAGE | 229 |
| LD0503B3 | CAMOUFLAGE | 229 |
| LD0503G3 | CAMOUFLAGE | 229 |

| | | |
|----------|------------|-----|
| LD0503S3 | CAMOUFLAGE | 229 |
| LD0505B3 | CAMOUFLAGE | 229 |
| LD0505G3 | CAMOUFLAGE | 229 |
| LD0505S3 | CAMOUFLAGE | 229 |
| LD0510B3 | CAMOUFLAGE | 230 |
| LD0510G3 | CAMOUFLAGE | 230 |
| LD0510S3 | CAMOUFLAGE | 230 |
| LD0515B3 | CAMOUFLAGE | 231 |
| LD0515G3 | CAMOUFLAGE | 231 |
| LD0515S3 | CAMOUFLAGE | 231 |
| LD0516B3 | CAMOUFLAGE | 230 |
| LD0516G3 | CAMOUFLAGE | 230 |
| LD0516S3 | CAMOUFLAGE | 230 |
| LD0517B3 | CAMOUFLAGE | 230 |
| LD0517G3 | CAMOUFLAGE | 230 |
| LD0517S3 | CAMOUFLAGE | 230 |
| LD0520B3 | CAMOUFLAGE | 230 |
| LD0520G3 | CAMOUFLAGE | 230 |
| LD0520S3 | CAMOUFLAGE | 230 |
| LD0530B3 | CAMOUFLAGE | 231 |
| LD0530G3 | CAMOUFLAGE | 231 |
| LD0530S3 | CAMOUFLAGE | 231 |
| LD0535B3 | CAMOUFLAGE | 231 |
| LD0535G3 | CAMOUFLAGE | 231 |
| LD0535S3 | CAMOUFLAGE | 231 |
| LD0540B3 | CAMOUFLAGE | 231 |
| LD0540G3 | CAMOUFLAGE | 231 |
| LD0540S3 | CAMOUFLAGE | 231 |
| LD0545B3 | CAMOUFLAGE | 231 |
| LD0545G3 | CAMOUFLAGE | 231 |
| LD0545S3 | CAMOUFLAGE | 231 |
| LD0550B3 | CAMOUFLAGE | 231 |
| LD0550G3 | CAMOUFLAGE | 231 |
| LD0550S3 | CAMOUFLAGE | 231 |
| LD0551B3 | CAMOUFLAGE | 231 |
| LD0551G3 | CAMOUFLAGE | 231 |
| LD0551S3 | CAMOUFLAGE | 231 |
| LD0555B3 | CAMOUFLAGE | 231 |
| LD0555G3 | CAMOUFLAGE | 231 |
| LD0555S3 | CAMOUFLAGE | 231 |
| LD0556B3 | CAMOUFLAGE | 231 |
| LD0556G3 | CAMOUFLAGE | 231 |
| LD0556S3 | CAMOUFLAGE | 231 |
| LGL0101 | GIULIETTA | 263 |
| LGL0105 | GIULIETTA | 263 |
| LGL0109 | GIULIETTA | 263 |
| LGL0120 | GIULIETTA | 263 |
| LGL0121 | GIULIETTA | 263 |
| LGL0122 | GIULIETTA | 263 |
| LGL0123 | GIULIETTA | 263 |
| LGL0124 | GIULIETTA | 263 |
| LGL1101 | GIULIETTA | 263 |

| | | |
|----------|--------------|-----|
| LGL1104 | GIULIETTA | 263 |
| LGL1105 | GIULIETTA | 263 |
| LGL1109 | GIULIETTA | 263 |
| LGL1120 | GIULIETTA | 263 |
| LGL1121 | GIULIETTA | 263 |
| LGL1122 | GIULIETTA | 263 |
| LGL1123 | GIULIETTA | 263 |
| LGL1124 | GIULIETTA | 263 |
| LGL2101 | GIULIETTA | 263 |
| LGL2104 | GIULIETTA | 263 |
| LGL2105 | GIULIETTA | 263 |
| LGL2109 | GIULIETTA | 263 |
| LGL2120 | GIULIETTA | 263 |
| LGL2121 | GIULIETTA | 263 |
| LGL2122 | GIULIETTA | 263 |
| LGL2123 | GIULIETTA | 263 |
| LGL2124 | GIULIETTA | 263 |
| LL0500B3 | CAMOUFLAGE | 230 |
| LL0500G3 | CAMOUFLAGE | 230 |
| LL0500S3 | CAMOUFLAGE | 230 |
| LL0501B3 | CAMOUFLAGE | 229 |
| LL0501G3 | CAMOUFLAGE | 229 |
| LL0501S3 | CAMOUFLAGE | 229 |
| LL0503B3 | CAMOUFLAGE | 229 |
| LL0503G3 | CAMOUFLAGE | 229 |
| LL0503S3 | CAMOUFLAGE | 229 |
| LL0505B3 | CAMOUFLAGE | 229 |
| LL0505G3 | CAMOUFLAGE | 229 |
| LL0505S3 | CAMOUFLAGE | 229 |
| LLG0107 | LAGUNA | 253 |
| LLG0115 | LAGUNA | 253 |
| LLG1107 | LAGUNA | 253 |
| LLG1115 | LAGUNA | 253 |
| LLG2107 | LAGUNA | 253 |
| LLG2115 | LAGUNA | 253 |
| LLQ0003 | LUCE LIQUIDA | 257 |
| LLQ0009 | LUCE LIQUIDA | 257 |
| LLQ0011 | LUCE LIQUIDA | 257 |
| LLQ0107 | LUCE LIQUIDA | 257 |
| LLQ0111 | LUCE LIQUIDA | 257 |
| LML0001 | MERLINO | 245 |
| LML0004 | MERLINO | 245 |
| LML0009 | MERLINO | 245 |
| LML0142 | MERLINO | 245 |
| LML0170 | MERLINO | 245 |
| LML0173 | MERLINO | 245 |
| LML1142 | MERLINO | 245 |
| LML1170 | MERLINO | 245 |
| LML1173 | MERLINO | 245 |
| LML2142 | MERLINO | 245 |
| LML2170 | MERLINO | 245 |
| LML2173 | MERLINO | 245 |
| LMR0001 | MARIPOSA | 293 |

| | | |
|----------|----------|-----|
| LMR0004 | MARIPOSA | 293 |
| LMR0005 | MARIPOSA | 293 |
| LMR0009 | MARIPOSA | 293 |
| LMR0020 | MARIPOSA | 293 |
| LMR0100 | MARIPOSA | 292 |
| LMR0101 | MARIPOSA | 292 |
| LMR0104 | MARIPOSA | 292 |
| LMR0105 | MARIPOSA | 292 |
| LMR0109 | MARIPOSA | 292 |
| LMR0120 | MARIPOSA | 292 |
| LMR0200 | MARIPOSA | 292 |
| LMR0201 | MARIPOSA | 292 |
| LMR0204 | MARIPOSA | 292 |
| LMR0205 | MARIPOSA | 292 |
| LMR0209 | MARIPOSA | 292 |
| LMR0220 | MARIPOSA | 292 |
| LMR1001 | MARIPOSA | 293 |
| LMR1002 | MARIPOSA | 293 |
| LMR1003 | MARIPOSA | 293 |
| LMR2001 | MARIPOSA | 293 |
| LMR2004 | MARIPOSA | 293 |
| LMR2005 | MARIPOSA | 293 |
| LMR2009 | MARIPOSA | 293 |
| LON0101B | ONDA | 275 |
| LON0104B | ONDA | 275 |
| LON0105B | ONDA | 275 |
| LON0109B | ONDA | 275 |
| LON0120B | ONDA | 275 |
| LON0121B | ONDA | 275 |
| LON0122B | ONDA | 275 |
| LON0123B | ONDA | 275 |
| LON0124B | ONDA | 275 |
| LON0500 | ONDA | 274 |
| LON0501 | ONDA | 274 |
| LON0504 | ONDA | 274 |
| LON0505 | ONDA | 274 |
| LON0509 | ONDA | 274 |
| LON0520 | ONDA | 274 |
| LON0521 | ONDA | 274 |
| LON0522 | ONDA | 274 |
| LON0523 | ONDA | 274 |
| LON0524 | ONDA | 274 |
| LON0600 | ONDA | 275 |
| LON0700 | ONDA | 274 |
| LON1500 | ONDA | 274 |
| LON2500 | ONDA | 274 |
| LON3500 | ONDA | 274 |
| LPR0101B | PERLE | 287 |
| LPR0106B | PERLE | 287 |
| LPR0107B | PERLE | 287 |
| LPR0109B | PERLE | 287 |
| LPR0111B | PERLE | 287 |
| LPR0113B | PERLE | 287 |

| | | |
|----------|-------|-----|
| LPR0201B | PERLE | 287 |
| LPR0206B | PERLE | 287 |
| LPR0207B | PERLE | 287 |
| LPR0209B | PERLE | 287 |
| LPR0211B | PERLE | 287 |
| LPR0213B | PERLE | 287 |
| LPR0301 | PERLE | 287 |
| LPR0306 | PERLE | 287 |
| LPR0307 | PERLE | 287 |
| LPR0309 | PERLE | 287 |
| LPR0311 | PERLE | 287 |
| LPR0313 | PERLE | 287 |
| LPR0401 | PERLE | 287 |
| LPR0406 | PERLE | 287 |
| LPR0407 | PERLE | 287 |
| LPR0409 | PERLE | 287 |
| LPR0411 | PERLE | 287 |
| LPR0413 | PERLE | 287 |
| LPR0501 | PERLE | 287 |
| LPR0506 | PERLE | 287 |
| LPR0507 | PERLE | 287 |
| LPR0509 | PERLE | 287 |
| LPR0511 | PERLE | 287 |
| LPR0513 | PERLE | 287 |
| LPR0601 | PERLE | 286 |
| LPR0606 | PERLE | 286 |
| LPR0607 | PERLE | 286 |
| LPR0609 | PERLE | 286 |
| LPR0611 | PERLE | 286 |
| LPR0613 | PERLE | 286 |
| LPR0701 | PERLE | 286 |
| LPR0706 | PERLE | 286 |
| LPR0707 | PERLE | 286 |
| LPR0709 | PERLE | 286 |
| LPR0711 | PERLE | 286 |
| LPR0713 | PERLE | 286 |
| LPR0801 | PERLE | 287 |
| LPR0806 | PERLE | 287 |
| LPR0807 | PERLE | 287 |
| LPR0809 | PERLE | 287 |
| LPR0813 | PERLE | 287 |
| LPR0901 | PERLE | 287 |
| LPR0906 | PERLE | 287 |
| LPR0907 | PERLE | 287 |
| LPR0909 | PERLE | 287 |
| LPR0913 | PERLE | 287 |
| LPR2601 | PERLE | 286 |
| LPR2606 | PERLE | 286 |
| LPR2607 | PERLE | 286 |
| LPR2609 | PERLE | 286 |
| LPR2611 | PERLE | 286 |
| LPR2613 | PERLE | 286 |
| LPR2701 | PERLE | 286 |

| | | |
|---------|--------|-----|
| LPR2706 | PERLE | 286 |
| LPR2707 | PERLE | 286 |
| LPR2709 | PERLE | 286 |
| LPR2711 | PERLE | 286 |
| LPR2713 | PERLE | 286 |
| LPR3601 | PERLE | 286 |
| LPR3606 | PERLE | 286 |
| LPR3607 | PERLE | 286 |
| LPR3609 | PERLE | 286 |
| LPR3611 | PERLE | 286 |
| LPR3613 | PERLE | 286 |
| LPR3701 | PERLE | 286 |
| LPR3706 | PERLE | 286 |
| LPR3709 | PERLE | 286 |
| LPR3711 | PERLE | 286 |
| LPR3713 | PERLE | 286 |
| LRG0501 | REGOLO | 281 |
| LRG0502 | REGOLO | 281 |
| LRG0504 | REGOLO | 281 |
| LRG0505 | REGOLO | 281 |
| LRG0511 | REGOLO | 281 |
| LRG0521 | REGOLO | 281 |
| LRG0522 | REGOLO | 281 |
| LRG0523 | REGOLO | 281 |
| LRG0524 | REGOLO | 281 |
| LRG0601 | REGOLO | 281 |
| LRG0602 | REGOLO | 281 |
| LRG0604 | REGOLO | 281 |
| LRG0605 | REGOLO | 281 |
| LRG0611 | REGOLO | 281 |
| LRG0621 | REGOLO | 281 |
| LRG0622 | REGOLO | 281 |
| LRG0623 | REGOLO | 281 |
| LRG0624 | REGOLO | 281 |
| LRG1501 | REGOLO | 281 |
| LRG1502 | REGOLO | 281 |
| LRG1504 | REGOLO | 281 |
| LRG1505 | REGOLO | 281 |
| LRG1511 | REGOLO | 281 |
| LRG1521 | REGOLO | 281 |
| LRG1522 | REGOLO | 281 |
| LRG1523 | REGOLO | 281 |
| LRG1524 | REGOLO | 281 |
| LRG1601 | REGOLO | 281 |
| LRG1602 | REGOLO | 281 |
| LRG1604 | REGOLO | 281 |
| LRG1605 | REGOLO | 281 |
| LRG1611 | REGOLO | 281 |
| LRG1621 | REGOLO | 281 |
| LRG1622 | REGOLO | 281 |
| LRG1623 | REGOLO | 281 |
| LRG1624 | REGOLO | 281 |
| LRM0101 | ROMEO | 263 |

| | | |
|----------|-------|-----|
| LRM0104 | ROMEO | 263 |
| LRM0105 | ROMEO | 263 |
| LRM0109 | ROMEO | 263 |
| LRM0120 | ROMEO | 263 |
| LRM0121 | ROMEO | 263 |
| LRM0122 | ROMEO | 263 |
| LRM0123 | ROMEO | 263 |
| LRM0124 | ROMEO | 263 |
| LRM1101 | ROMEO | 263 |
| LRM1104 | ROMEO | 263 |
| LRM1105 | ROMEO | 263 |
| LRM1109 | ROMEO | 263 |
| LRM1120 | ROMEO | 263 |
| LRM1121 | ROMEO | 263 |
| LRM1122 | ROMEO | 263 |
| LRM1123 | ROMEO | 263 |
| LRM1124 | ROMEO | 263 |
| LRM2101 | ROMEO | 263 |
| LRM2104 | ROMEO | 263 |
| LRM2105 | ROMEO | 263 |
| LRM2109 | ROMEO | 263 |
| LRM2120 | ROMEO | 263 |
| LRM2121 | ROMEO | 263 |
| LRM2122 | ROMEO | 263 |
| LRM2123 | ROMEO | 263 |
| LRM2124 | ROMEO | 263 |
| LSH0201B | SHOW | 278 |
| LSH0204B | SHOW | 278 |
| LSH0205B | SHOW | 278 |
| LSH0209B | SHOW | 278 |
| LSH0211B | SHOW | 278 |
| LSH0220B | SHOW | 278 |
| LSH0221N | SHOW | 278 |
| LSH0222N | SHOW | 278 |
| LSH0301B | SHOW | 278 |
| LSH0304B | SHOW | 278 |
| LSH0305B | SHOW | 278 |
| LSH0309B | SHOW | 278 |
| LSH0311B | SHOW | 278 |
| LSH0320B | SHOW | 278 |
| LSH0321N | SHOW | 278 |
| LSH0322N | SHOW | 278 |
| LSH0601B | SHOW | 278 |
| LSH0604B | SHOW | 278 |
| LSH0605B | SHOW | 278 |
| LSH0609B | SHOW | 278 |
| LSH0611B | SHOW | 278 |
| LSH0620B | SHOW | 278 |
| LSH0621N | SHOW | 278 |
| LSH0622N | SHOW | 278 |
| LSH0701B | SHOW | 278 |
| LSH0704B | SHOW | 278 |
| LSH0705B | SHOW | 278 |

| | | |
|----------|-----------|-----|
| LSH0709B | SHOW | 278 |
| LSH0711B | SHOW | 278 |
| LSH0720B | SHOW | 278 |
| LSH0721N | SHOW | 278 |
| LSH0722N | SHOW | 278 |
| LSH1201B | SHOW | 279 |
| LSH1204B | SHOW | 279 |
| LSH1205B | SHOW | 279 |
| LSH1209B | SHOW | 279 |
| LSH1211B | SHOW | 279 |
| LSH1220B | SHOW | 279 |
| LSH1221N | SHOW | 279 |
| LSH1222N | SHOW | 279 |
| LSH1301B | SHOW | 279 |
| LSH1304B | SHOW | 279 |
| LSH1305B | SHOW | 279 |
| LSH1309B | SHOW | 279 |
| LSH1311B | SHOW | 279 |
| LSH1320B | SHOW | 279 |
| LSH1321N | SHOW | 279 |
| LSH1322N | SHOW | 279 |
| LSH2201B | SHOW | 279 |
| LSH2204B | SHOW | 279 |
| LSH2205B | SHOW | 279 |
| LSH2209B | SHOW | 279 |
| LSH2211B | SHOW | 279 |
| LSH2220B | SHOW | 279 |
| LSH2221N | SHOW | 279 |
| LSH2222N | SHOW | 279 |
| LSH2301B | SHOW | 279 |
| LSH2304B | SHOW | 279 |
| LSH2305B | SHOW | 279 |
| LSH2309B | SHOW | 279 |
| LSH2311B | SHOW | 279 |
| LSH2320B | SHOW | 279 |
| LSH2321N | SHOW | 279 |
| LSH2322N | SHOW | 279 |
| LSL0001 | SEVENTIES | 239 |
| LSL0011 | SEVENTIES | 239 |
| LSL0114 | SEVENTIES | 239 |
| LSL1114 | SEVENTIES | 239 |
| LSL2114 | SEVENTIES | 239 |
| LSL3114 | SEVENTIES | 239 |
| LSL4114 | SEVENTIES | 240 |
| LSL5114 | SEVENTIES | 240 |
| LSL6114 | SEVENTIES | 241 |
| LSL7114 | SEVENTIES | 241 |

RELAMPING KIT attacco con magneti / magnet fixing



| COD. | DIMENSION | *DIMENSION 1 | *DIMENSION 2 | WATT | TOTAL W | Lm LED | BEAM ANGLE |
|---------------|------------------------------|------------------------------|------------------------------------|------|---------|--------|------------|
| LDSK14 | Ø 5 x 4 cm Ø 2 x 1,6 in | Ø 6 x 5 cm Ø 2,4 x 1,9 in | 6 x 6 x 5 cm 2,4 x 2,4 x 1,9 in | 4 W | 4 W | 420 lm | 120° |
| LDSK15 | Ø 7 x 4 cm Ø 2,7 x 1,6 in | Ø 8 x 5 cm Ø 3,1 x 1,9 in | 8 x 8 x 5 cm 3,1 x 3,1 x 1,9 in | 8 W | 8 W | 750 lm | 120° |

Led 2700-4000K su richiesta/on request

| COD. | DIMENSION | *DIMENSION 1 | *DIMENSION 2 | WATT | TOTAL W | Lm LED | BEAM ANGLE |
|---------------|-------------------------------------------|---------------------------------|---------------------------------------|-------|---------|---------|------------|
| LDSK16 | 14,1 x 4,4 x 4,3 cm 5,5 x 1,7 x 1,7 in | Ø 15,5 x 5 cm Ø 6,1 x 1,9 in | 15,5 x 6 x 5 cm 6,1 x 2,3 x 1,9 in | 8,7 W | 10 W | 1310 lm | 120° |

Led 2700-4000K su richiesta/on request

| COD. | DIMENSION | *DIMENSION 1 | *DIMENSION 2 | WATT | TOTAL W | Lm LED | BEAM ANGLE |
|---------------|---------------------------------|---------------------------------|----------------------------------------|--------|---------|---------|------------|
| LDSK01 | Ø 17 x 3,5 cm Ø 6,7 x 1,4 in | Ø 18 x 4,5 cm Ø 7,1 x 1,8 in | 18 x 18 x 4,5 cm 7,1 x 7,1 x 1,8 in | 10,5 W | 12,5 W | 1350 lm | 120° |
| LDSK02 | Ø 22 x 4 cm Ø 8,6 x 1,6 in | Ø 23 x 5 cm Ø 9 x 1,9 in | 23 x 23 x 5 cm 9 x 9 x 1,9 in | 17 W | 18,5 W | 2200 lm | 120° |
| LDSK03 | Ø 29 x 4 cm Ø 11,4 x 1,6 in | Ø 30 x 5 cm Ø 11,8 x 1,9 in | 30 x 30 x 5 cm 11,8 x 11,8 x 1,9 in | 27,5 W | 29 W | 3450 lm | 120° |

Led 2700-4000K su richiesta/on request

| COD. | DIMENSION | *DIMENSION 1 | *DIMENSION 2 | WATT | TOTAL W | Lm LED | DIMMER | BEAM ANGLE |
|---------------|---------------------------------|---------------------------------|----------------------------------------|--------|---------|---------|--------|------------|
| LDSK17 | Ø 17 x 3,5 cm Ø 6,7 x 1,4 in | Ø 18 x 4,5 cm Ø 7,1 x 1,8 in | 18 x 18 x 4,5 cm 7,1 x 7,1 x 1,8 in | 10,5 W | 12,5 W | 1350 lm | TRIAC | 120° |
| LDSK18 | Ø 17 x 3,5 cm Ø 6,7 x 1,4 in | Ø 18 x 4,5 cm Ø 7,1 x 1,8 in | 18 x 18 x 4,5 cm 7,1 x 7,1 x 1,8 in | 10,5 W | 12,5 W | 1350 lm | DALI | 120° |
| LDSK19 | Ø 17 x 3,5 cm Ø 6,7 x 1,4 in | Ø 18 x 4,5 cm Ø 7,1 x 1,8 in | 18 x 18 x 4,5 cm 7,1 x 7,1 x 1,8 in | 10,5 W | 12,5 W | 1350 lm | WI-FI | 120° |
| LDSK20 | Ø 22 x 4 cm Ø 8,6 x 1,6 in | Ø 23 x 5 cm Ø 9 x 1,9 in | 23 x 23 x 5 cm 9 x 9 x 1,9 in | 17 W | 18,5 W | 2200 lm | TRIAC | 120° |
| LDSK21 | Ø 22 x 4 cm Ø 8,6 x 1,6 in | Ø 23 x 5 cm Ø 9 x 1,9 in | 23 x 23 x 5 cm 9 x 9 x 1,9 in | 17 W | 18,5 W | 2200 lm | DALI | 120° |
| LDSK22 | Ø 22 x 4 cm Ø 8,6 x 1,6 in | Ø 23 x 5 cm Ø 9 x 1,9 in | 23 x 23 x 5 cm 9 x 9 x 1,9 in | 17 W | 18,5 W | 2200 lm | WI-FI | 120° |
| LDSK23 | Ø 29 x 4 cm Ø 11,4 x 1,6 in | Ø 30 x 5 cm Ø 11,8 x 1,9 in | 30 x 30 x 5 cm 11,8 x 11,8 x 1,9 in | 27,5 W | 29 W | 3450 lm | TRIAC | 120° |
| LDSK24 | Ø 29 x 4 cm Ø 11,4 x 1,6 in | Ø 30 x 5 cm Ø 11,8 x 1,9 in | 30 x 30 x 5 cm 11,8 x 11,8 x 1,9 in | 27,5 W | 29 W | 3450 lm | DALI | 120° |
| LDSK25 | Ø 29 x 4 cm Ø 11,4 x 1,6 in | Ø 30 x 5 cm Ø 11,8 x 1,9 in | 30 x 30 x 5 cm 11,8 x 11,8 x 1,9 in | 27,5 W | 29 W | 3450 lm | WI-FI | 120° |

***DIMENSION 1**
Superficie circolare minima per alloggiamento kit / Min housing for kit on a circular surface.

***DIMENSION 2**
Superficie rettangolare minima per alloggiamento kit / Min housing for kit on a rectangular surface.



Led 2700-4000K su richiesta/on request

| COD. | DIMENSION | *DIMENSION 1 | *DIMENSION 2 | WATT | TOTAL W | Lm LED | BEAM ANGLE |
|---------------|-----------------------------------------|--------------------------------|----------------------------------------|--------|----------|---------|------------|
| LDSK11 | 26,2 x 17 x 5 cm 10,3 x 6,7 x 1,9 in | Ø 32 x 6 cm Ø 12,6 x 2,4 in | 27 x 18 x 6 cm 10,6 x 7,1 x 2,4 in | 10,5 W | 5-12,5 W | 1350 lm | 120° |
| LDSK12 | 26,2 x 20 x 5 cm 10,3 x 7,9 x 1,9 in | Ø 32 x 6 cm Ø 12,6 x 2,4 in | 27 x 23 x 6 cm 10,6 x 9 x 2,4 in | 17 W | 5-18,5 W | 2200 lm | 120° |
| LDSK13 | 29 x 29 x 5 cm 11,4 x 11,4 x 1,9 in | Ø 32 x 6 cm Ø 12,6 x 2,4 in | 32 x 30 x 6 cm 12,6 x 11,8 x 2,4 in | 27,5 W | 5-29 W | 3450 lm | 120° |

Versione con dispositivo di emergenza integrato, con autonomia di 3 ore.
Version with integrated emergency device, with autonomy of 3 hours.

G9 DIMMER TRIAC CRI=90 220-240V

| COD. | DIMENSION | WATT | Lm LED | COLOUR TEMPERATURE | BEAM ANGLE |
|------------------|--------------------------------------|-------|--------|--------------------|------------|
| LD0180900 | Ø 1,7 x h 6,2 cm Ø 0,6 x h 2,4 in | 4,5 W | 500 lm | 3000 K | 360° |
| LD0180901 | Ø 1,7 x h 6,2 cm Ø 0,6 x h 2,4 in | 4,5 W | 480 lm | 2700 K | 360° |

***DIMENSION 1**
Superficie circolare minima per alloggiamento kit / Min housing for kit on a circular surface.

***DIMENSION 2**
Superficie rettangolare minima per alloggiamento kit / Min housing for kit on a rectangular surface.

Rosone rettangolare per sospensioni multiple Rectangular canopy for hanging multiple lamps

Esempio d'installazione / Example of installation

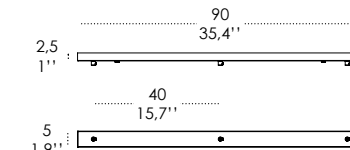

Rosone per sospensione 3 luci
Canopy for hanging lamp 3 lights

LGR0043 grigio / grey
LGR0053 bianco / white

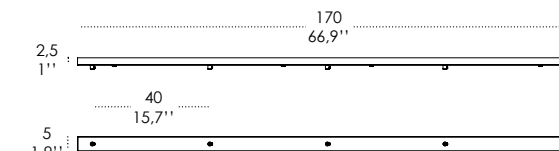

Rosone per sospensione 5 luci
Canopy for hanging lamp 5 lights

LGR0045 grigio / grey
LGR0055 bianco / white

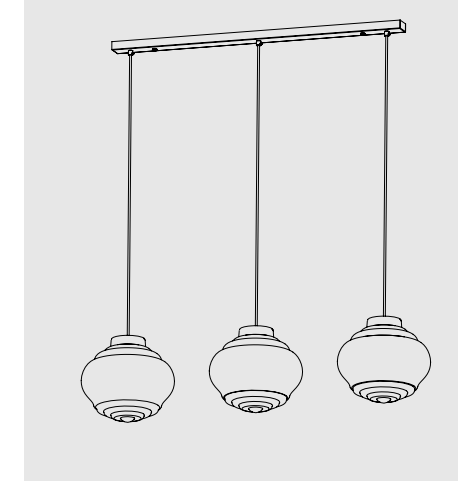

Rosone tondo per sospensioni multiple / Round canopy for hanging multiple lamps

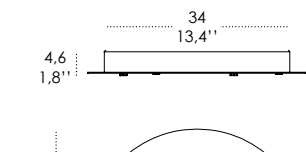

Rosone per sospensione 3 luci
Canopy for hanging lamp 3 lights

LGR0063 grigio / grey
LGR0073 bianco / white

Luci disposte sullo stesso livello
Lights on the same level:
Ø max 25 cm - 9,8 in

Disponibile su richiesta con finitura calamina / Available on request with calamine finish

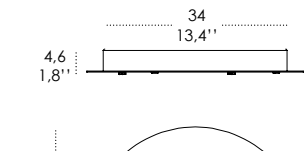

Rosone per sospensione 5 luci
Canopy for hanging lamp 5 lights

LGR0045 grigio / grey
LGR0075 bianco / white

Luci disposte sullo stesso livello
Lights on the same level:
Ø max 17 cm - 6,7 in

Disponibile su richiesta con finitura calamina / Available on request with calamine finish

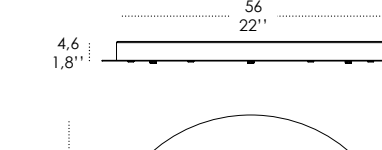
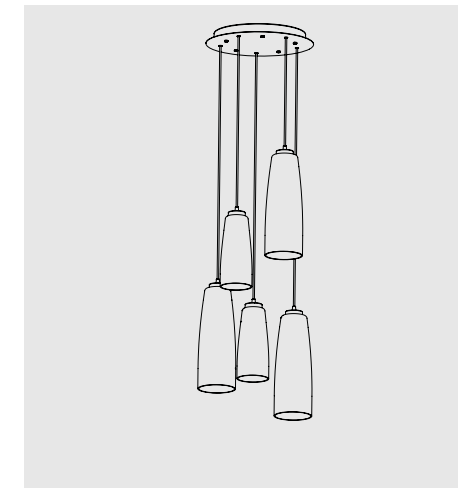
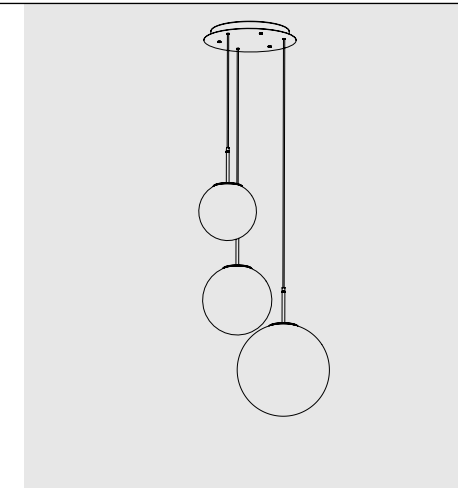

Rosone per sospensione 7 luci
Canopy for hanging lamp 7 lights

LGR0086 grigio / grey
LGR0096 bianco / white

Luci disposte sullo stesso livello
Lights on the same level:
Ø max 24 cm - 9,4 in

Disponibile su richiesta con finitura calamina / Available on request with calamine finish

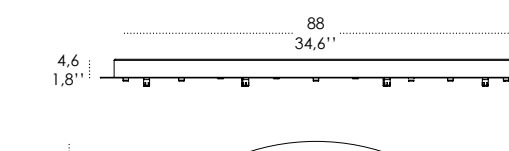

Rosone per sospensione 13 luci
Canopy for hanging lamp 13 lights

LGR0113 grigio / grey
LGR0213 bianco / white

Luci disposte sullo stesso livello
Lights on the same level:
Ø max 21 cm - 8,2 in

Disponibile su richiesta con finitura calamina / Available on request with calamine finish

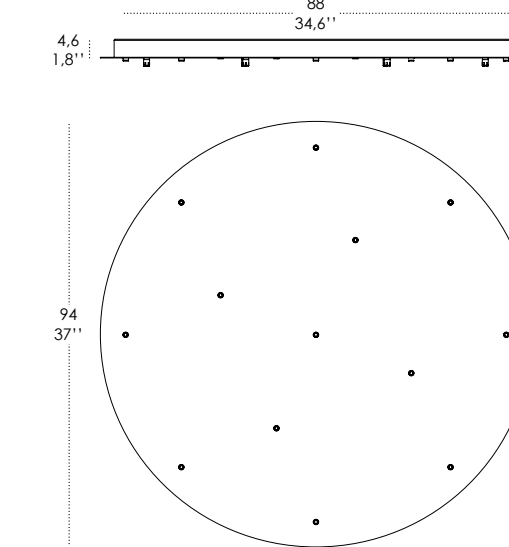

Esempio d'installazione / Example of installation

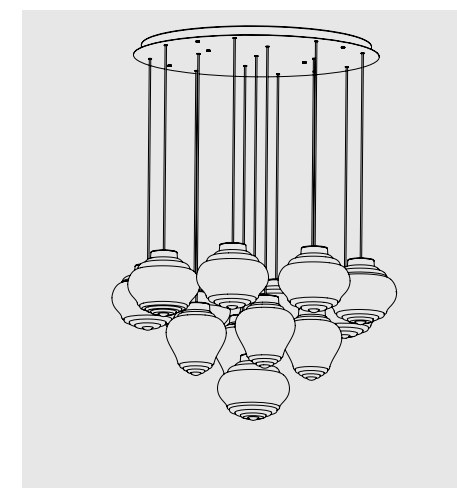
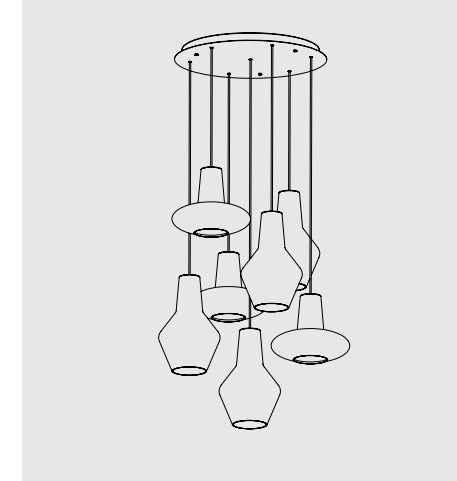

ROSONI / CANOPIES

Rosone singolo / Single canopy



Rosone per sospensioni multiple (supporti di decentramento inclusi) Canopy for hanging multiple lamps (decentralisation supports included)



Esempio d'installazione / Example of installation

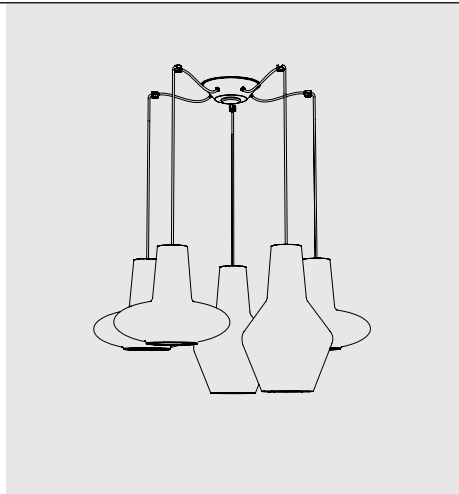

 (n) Supporti per decentramento cavi inclusi.
Supports for cable decentralisation included.

Rosone per sospensioni multiple (supporti di decentramento esclusi) Canopy for hanging multiple lamps (decentralisation supports not included)

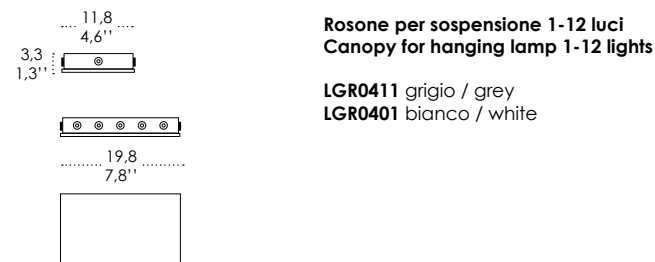

**Rosone per sospensione 1-12 luci
Canopy for hanging lamp 1-12 lights**
LGR0411 grigio / grey
LGR0401 bianco / white



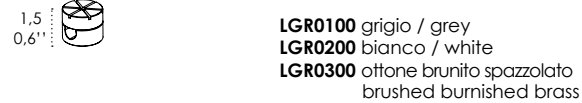

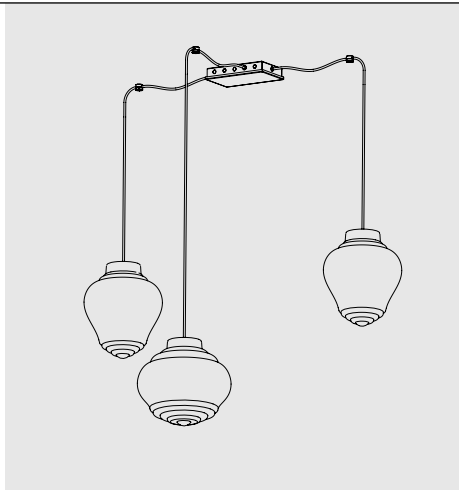

**Supporto singolo per decentramento cavo.
Single support for cable decentralisation.**



LGR0100 grigio / grey
LGR0200 bianco / white
LGR0300 ottone brunito spazzolato
brushed burnished brass



SIMBOLI / SYMBOLS

| | |
|-----------------------------------------------------------------------------------------------------------------------------------------------------------------------------------------------------------------------------------------------------------------------------------------------------------------------------------------------------------------|------------------------------------------------------------------------------------------------------------------------------------------------------------------------------------------------------------------------------------------------------------------------------------------------------------------------------------------------------------------------------------------------------------------------------------------------------------------------------------------------------------------------------------------------------------------------------------------------------------------------------------------------------------------------------------------------------------------|
| IP | GRADO DI PROTEZIONE / IP PROTECTION RATING Le due cifre dopo la sigla IP identificano il grado di protezione contro l'intrusione di corpi solidi e liquidi. <i>The two numbers after the heading IP identify the protection rating against the intrusion of solids and liquids</i> |
| | PRIMA CIFRA / FIRST IDENTIFICATION NUMBER 0 - Nessuna protezione / no protection 1 - Protezione da oggetti solidi maggiori di 50 mm / protection by solid objects with diameter > 1,9 in 2 - Protezione da oggetti solidi maggiori di 12 mm / protection by solid objects with diameter > 0,5 in 3 - Protezione da oggetti solidi maggiori di 2,5 mm / protection by solid objects with diameter > 0,1 in 4 - Protezione da oggetti solidi maggiori di 1 mm / protection by solid objects with diameter > 0,04 in 5 - Protezione da polveri / protection by dust 6 - Protezione forte da polveri / high protection against dust |
| | SECONDA CIFRA / SECOND IDENTIFICATION NUMBER 0 - Nessuna protezione / no protection 1 - Protezione da gocce d'acqua / protection by water drops 2 - Protezione da gocce d'acqua deviate fino a 15° / protection by water drops with angle 15° 3 - Protezione da vapori d'acqua / protection by steams 4 - Protezione da spruzzi d'acqua / protection by water spray 5 - Protezione da getti d'acqua / protection by water jets 6 - Protezione da forti getti d'acqua o mareggiate / protection by intensive water jets or storm 7 - Protezione contro l'immersione / protection by immersion 8 - Protezione contro l'immersione continua / protection by continuous immersion. |
| |  Lampada adatta all'uso indoor / lamp suitable for indoor use |
|  Lampada adatta all'uso outdoor / lamp suitable for outdoor use | |
|  Lampada dimmerabile / dimmable lamp | |
|  L'apparecchio non può essere usato su superfici infiammabili / The fixture must not be used on flammable surfaces. | |
|  Tutti i prodotti descritti nel catalogo rispondono ai requisiti essenziali delle direttive 73-23-CEE, 93-68-CEE. <i>All the products listed in the catalogue are in compliance with the fundamental requisites of the directives EEC 73-23, EEC 93-68, EEC 89-336.</i> | |
|  Classe 2 / Class 2 | |
|  Classe 3 / Class 3 | |
| cm Unità di misura in centimetri / <i>Unit of measurement centimeters</i> | |
| " Unità di misura in pollici / <i>Unit of measurement inches</i> | |

Le immagini sono puramente indicative; forme e colori possono differire sensibilmente dall'originale a causa della ripresa fotografica e del sistema di stampa. Tutti i modelli rappresentati possono subire nel tempo variazioni senza preavviso; prima di eseguire un ordine d'acquisto contattare l'azienda per accertarne la corrispondenza. Tutti i diritti riservati Zafferano, riproduzione vietata se non espressamente autorizzata.

The photos are entirely indicative; shapes and colours may differ significantly from the original due to the photo shoot and the printing system. All the models shown may be changed over time without any prior notice. Before placing an order, please contact the company to check the right match. All rights are reserved by Zafferano and reproduction is prohibited unless expressly authorised.

AI LATHS
LATI



BESPOKE

AiLati - Zafferano Bespoke

are trademarks of



Zafferano Srl

Viale dell'Industria, 26
31055 - Quinto di Treviso - Italia
T +39 0422 470507
F +39 0422 470400
sales@ailatights.it
www.zafferanoitalia.com

Zafferano America LLC

108 Thompson Street
1319 North Broad St
Hillside, NJ 07205 - USA
Tel +1 888 744 5277
info@zafferanoamerica.com
www.zafferanoamerica.com

© Copyright Zafferano srl

Photo **Studio Pointer**
Rendart

Graphic **Studio Pointer**
Thanks to **Quellenhof**
Valentini Interiors

Printing **Cross Value Srl**
Printed **July 2020**

